

# Aesculap Surgical Instruments

General Catalog

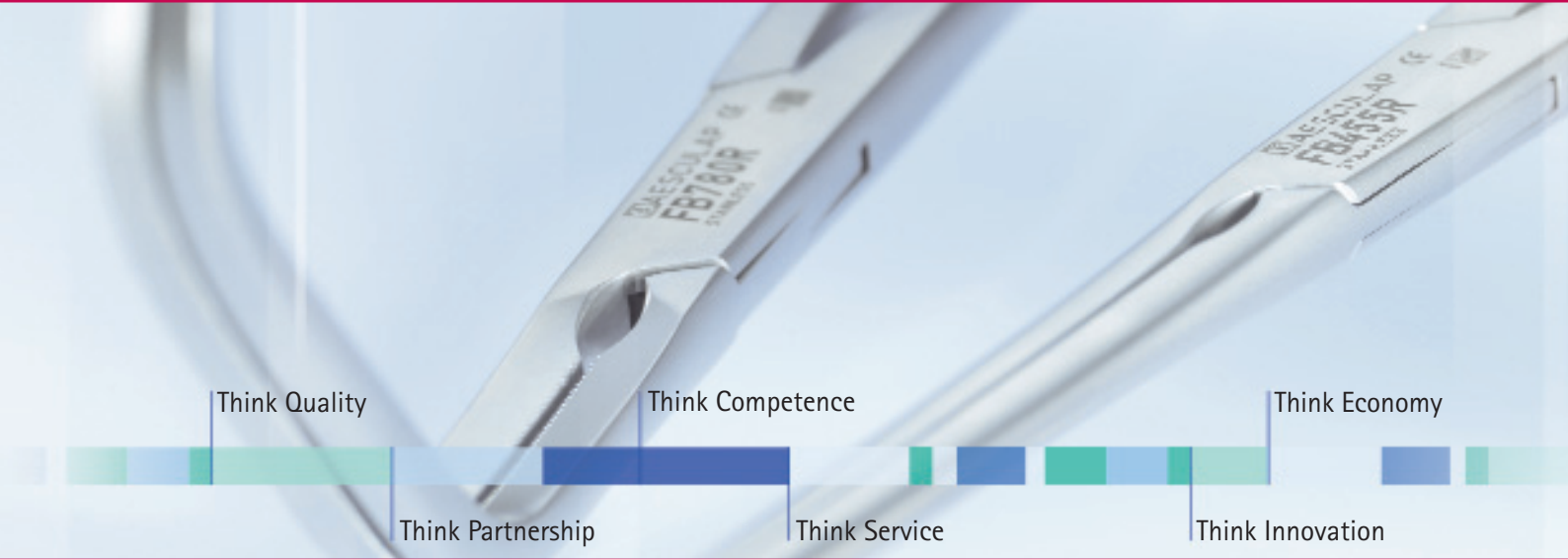

Think Surgical Instruments. Think Aesculap.

## Think Aesculap.

Profundes Wissen setzt die Vernetzung von Kenntnissen und Erfahrungen sowie deren folgerichtige Bewertung voraus. Ein Prinzip, dem B. Braun seit über 160 Jahren konsequent folgt und welches sich daher auch in der Aussage „Sharing Expertise“ ausdrücklich widerspiegelt. Ein Wissensaustausch über alle Sparten des Konzerns hinweg schafft eine breitere und somit fundiertere Wissensbasis für alle Beteiligten. Das Ergebnis sind bis ins Detail durchdachte, weitsichtige Lösungen und ein Höchstmaß an Sicherheit. Zum Wohl des Patienten und im Interesse der Anwender.

Mit über 130 Jahren Erfahrung im Segment der chirurgischen Instrumente ist die Sparte Aesculap kompetenter Partner für den interdisziplinären Wissensaustausch.

Die Produktmarke Aesculap steht für ein vielfältiges Leistungsspektrum, das hochwertige Produkte mit prozessorientierten Dienstleistungen intelligent und im Sinne der Wirtschaftlichkeit verknüpft. Aesculap ist ein verlässlicher und akzeptierter Partner für den gesamten chirurgischen Prozessablauf in der Klinik.

Dass Aesculap zu den Besten der Branche gehört, verdankt das Unternehmen seinen Mitarbeiterinnen und Mitarbeitern, die sich auf der Suche nach der bestmöglichen Lösung nie mit der ersten Idee zufrieden geben. Menschen, die jede Entwicklung immer wieder prüfen, hinterfragen und optimieren.

Deshalb ist Aesculap weit mehr als ein Lieferant hochpräziser chirurgischer Instrumente: ein Partner, der genau zuhört und mitdenkt, die Bedürfnisse und Anforderungen seiner Kunden versteht und sie auf hohem Niveau versorgt. Vom Produkt über Dienstleistungen und Seminare für alle Funktionsbereiche.



### Think Quality

### Think Partnership



- Bei Verträgen halte ich es wie in einer Partnerschaft: gegenseitiges Vertrauen und Wertschätzung sind die Basis.

**Think Partnership.** Think Aesculap.

### Think Competence



- Das Informations- und Beratungszentrum in Tuttlingen ist weltweit einmalig. An keinem anderen Ort könnte ich so überzeugend und mit einer solchen Auswahl beraten!

**Think Competence.** Think Aesculap.



- || Unsere Instrumente werden von Chirurgen auf der ganzen Welt geschätzt. Ich weiß, warum das so ist und Sorge dafür, dass es so bleibt.

**Think Quality.** Think Aesculap.

- || Am Anfang sind meine Gesprächspartner manchmal skeptisch: hohe Qualität und trotzdem eine wirtschaftlich sinnvolle Lösung? Dann lasse ich einfach Fakten sprechen.

**Think Economy.** Think Aesculap.



Think Economy

### Think Service



- || Manchmal sorgen wir auch mit Kleinigkeiten für einen reibungslosen Prozess. Hauptsache alles läuft und alle sind zufrieden.

**Think Service.** Think Aesculap.

### Think Innovation



- || Jedes neue Produkt ist wie ein eigenes Baby. Man kümmert sich liebevoll darum, bis es irgendwann das Haus verlässt.

**Think Innovation.** Think Aesculap.

## Think Quality. Think Aesculap.

Um den eigenen hohen Ansprüchen und den Erwartungen der Anwender in allen Bereichen gerecht zu werden, sind auch die Aesculap Qualitätsanforderungen außerordentlich hoch. Bei mehr als 17.000 Produkten, die nahezu alle Indikationen der einzelnen Fachbereiche abdecken, kein einfaches Unterfangen.

Von vornherein hat man sich daher eine eigene Qualitätsnorm auferlegt, die die erlaubten DIN/ISO Standard-Toleranzen in jeder Hinsicht stark begrenzt. Das macht sich bereits bei der Auswahl und Prüfung der Werkstoffe bemerkbar und setzt sich über den gesamten Fertigungsprozess fort.

Die auf einer Symbiose aus Hightech und Handarbeit basierende Herstellungstechnik der Instrumente sowie eine hohe Fertigungstiefe ermöglichen Modelltreue und höchste Präzision in stets gleichbleibender Qualität.

Bei Aesculap weiß man schließlich seit über 130 Jahren, dass es nichts Wirtschaftlicheres gibt, als eine hohe Qualität.



### ■ Qualitätssicherung

Ein wesentlicher Bestandteil des umfangreichen Qualitätsmanagementsystems ist der integrierte Ablauf von der Produktidee, über die Entwicklung, die Produktion bis zum geprüften fertigen Instrument. Dies beinhaltet moderne Fertigungsverfahren und gesicherte Prozessabläufe inklusive systematischer Qualitätskontrollen, um die konstant hohe Aesculap Qualität zu sichern.





■ Nur mit dem Know-how, der Erfahrung und Sorgfalt der Aesculap Chirurgiemechaniker lässt sich reproduzierbare Aesculap Qualität über Jahrzehnte hinaus garantieren. Wissen, das man verantwortungsvoll weitergibt.



### Hartmetall-Instrumente

Bei Instrumenten mit Hartmetall-Einlagen verwenden wir nur hochwertige nickelgebundene Hartmetall-Plättchen, die sich durch eine hohe Korrosionsbeständigkeit und einen geringen Verschleiß auszeichnen.



### Arterienklemme – Olive im Maulbereich

Die Olive bildet den Übergang vom Arbeitsende zum „Schluss“ des Instrumentes. Durch diese besondere Anatomie wird das Maul elastischer und das Instrument weniger bruchanfällig.



Wie wir erreichen, dass jedes Aesculap Instrument präzise den Formen und Abmessungen des Masters entspricht?  
Wir kontrollieren jedes einzelne Instrument!

## Think Innovation. Think Aesculap.

Im kontinuierlichen Dialog mit Praktikern und klinischen Partnern entwickelt und realisiert Aesculap Instrumente für alle chirurgischen Disziplinen – nicht selten mit Vorbildcharakter. Weltweit arbeitet ein Team von etwa 200 Mitarbeitern im Bereich Forschung und Entwicklung an neuen, wirtschaftlich tragbaren Lösungen im Sinne einer bestmöglichen Patientenversorgung.

Nicht das technologisch Machbare, sondern das medizinisch Sinnvolle steht dabei grundsätzlich im Mittelpunkt.

Sinnvolle Entwicklungen bedeuten für uns, den Verlauf eines chirurgischen Eingriffs durch die Funktionalität des eingesetzten Instrumentariums unter wirtschaftlichen Gesichtspunkten entscheidend positiv zu beeinflussen, wie zum Beispiel:



### BipoJet

Bipolare Präparierschere für die offene Chirurgie

BipoJet ermöglicht Präparieren, mechanisches Schneiden und Koagulieren in einem Arbeitsgang. Dies bedeutet für den Chirurgen, dass er mit BipoJet noch schneller, sicherer und effizienter arbeiten kann. Neuartige Fertigungstechnologien wie der solide Keramikeinsatz im Scherenblatt sowie eine PEEK-Kunststoffbeschichtung stehen für die Langlebigkeit und elektrische Sicherheit. Für die Klinik bedeuten Effizienz, Sicherheit und Langlebigkeit einen wichtigen wirtschaftlichen Vorteil.



### Retraktionssystem Münster

Das Retraktionssystem Münster, mittlerweile ein Synonym für Variabilität, Flexibilität und Stabilität in der Abdominalchirurgie, wurde in seiner Weiterentwicklung durch einen neuen offenen Rahmen ergänzt. Dieser ist durch eine neuartige Gelenktechnologie stufenlos in drei Ebenen leicht und schnell verstellbar. Für den Anwender bedeutet dies noch mehr Freiraum und Anpassungsfähigkeit des Systems an die individuelle OP-Situation.



### Mikro-Instrumente

für die Herz- und Gefäßchirurgie

Hergestellt mit modernsten Fertigungstechnologien aus ausgewählten Materialien für ausgezeichnete Funktionalität. Die Arbeitsflächen der Maulteile von Nadelhaltern und Pinzetten sind mit der Aesculap DIADUST Diamantstaub-Beschichtung versehen. Das Ergebnis: eine harte Arbeitsfläche mit hoher Verschleißfestigkeit. Darüber hinaus bietet DIADUST-Beschichtung ein zuverlässiges Fassen von feinen Nadeln sowie von Weichgewebe.

## Gemeinschaftsentwicklung



Bei der Neu- und Weiterentwicklung von chirurgischen Instrumenten arbeitet Aesculap eng mit den Anwendern zusammen. So entstehen hochwertige Produkte, die Maßstäbe setzen und bis ins Detail den Wünschen und Anforderungen des Chirurgen entsprechen.

Aus dieser Kooperation zwischen Aesculap Spezialisten und erfahrenen Anwendern erwachsen wertvolle Synergie-Effekte und außergewöhnliche Projekte, die immer wieder maßgebliche Innovationen im Bereich der chirurgischen Instrumente hervorbringen.

Ein straff konzipiertes Projektmanagementsystem sorgt zudem für Transparenz und Effizienz der Aesculap Entwicklungsprojekte.

## BipoJet – ein Beispiel aus der Praxis



Prof. Dr. med. Gottfried Müller ist Chefarzt der Chirurgischen Klinik im Caritas-Krankenhaus Bad Mergentheim und seit über 20 Jahren maßgeblich in die Entwicklung von Aesculap chirurgischen Instrumenten involviert.

„Eine über 20-jährige erfolgreiche und angenehme Zusammenarbeit mit Aesculap an einer Vielzahl von Projektideen bedeutet für mich freundschaftliches und vertrauensvolles Zuhören, fachlich fundiertes Diskutieren, exaktes Recherchieren und Programmieren von Projekten in Untertiteln: Innovation, Sinnhaftigkeit, Markterwartung, Funktion, Ergonomie, Material, Qualität, Fertigung, Recherche, Überprüfung, Funktionalität, Sicherheit, Zuverlässigkeit, klinische Kontrolle, Praktikabilität, Wirtschaftlichkeit, Systemtauglichkeit und Marktverträglichkeit. All diese Schlagworte stehen hinter Projekten, die für mich interessant waren und sind.

Aesculap bedeutet für mich aber auch die persönliche Verbindung mit interessanten Menschen, die ihre Erfahrung und

Kraft in viele Kontakte einbringen, wie Ingenieure, Mechaniker, Sekretärinnen, Betriebswirte, Mediziner und Entwickler, viele kreative Frauen und Männer aller Berufsklassen.

Aesculap zu kennen heißt für mich, Einblick in eine große seriöse Einheit zu haben, deren Aufgabe es ist, Produkte für die Medizin zu liefern – also Dinge, die mit uns Chirurgen direkt zu tun haben. Aesculap ist vor diesem Hintergrund für jeden Chirurg ein Begriff. Dahinter stehen für mich Menschen am Schreibtisch und am Schraubstock, die sich mit allem Einsatz für Projekte in Zusammenarbeit zur Verfügung stellen, Projekte, die meine medizinische Zukunft mitbestimmen.

Jüngstes Beispiel hierfür ist die gemeinsame Entwicklung von BipoJet.“

Dr. med. Albert Linder ist Chefarzt der Abteilung Thorax-Chirurgie an der Lungenklinik Hemer und von der Idee „aus der Praxis für die Praxis“ überzeugt. Herr Dr. Linder arbeitet seit mehr als 10 Jahren als klinischer Berater eng mit Aesculap zusammen.

„Die Entwicklung der BipoJet-Schere ist ein hervorragendes Beispiel dafür, wie Anwenderideen aus der täglichen Arbeit im OP in kurzer Zeit zu einem marktreifen High-Tech-Produkt werden können. Bei Aesculap geschieht das in ausgezeichneter Kooperation zwischen Chirurg und Entwicklungsteam und immer vor Ort, mal im OP, mal in der Werkstatt.“





Projektberatung mit allen Funktionsbereichen der Klinik im Informations- und Beratungszentrum (IBZ) in Tuttlingen.

Durch stetige Veränderungen im Gesundheitsmarkt, der Einführung der DRGs sowie des Total Quality Managements gewinnt das Thema „Investition in chirurgische Techniken“ enorm an Brisanz – und etwaige Fehlentscheidungen lassen sich im Nachhinein nur schwer korrigieren.

Das Team der Aesculap Projektplanung, Fachleute mit Know-how und operationellem Sachverstand, unterstützt Krankenhäuser und Kliniken bei der Planung kleiner und großer Projekte und setzt sie routiniert, zeitnah und zuverlässig um. Weltweit.

Das Team kooperiert mit Architekten, Technikern, Ärzten, Pflegepersonal und Verwaltung, analysiert Abläufe, ermittelt Bedarfe und schafft die Voraussetzung für optimierte Prozesse. Das Ergebnis ist eine fundierte Projektierung, die von A bis Z funktionierte. Ob Neubau einer Klinik oder Aufbau einer neuen Disziplin.

### ■ Hospitationen

Vor einer geplanten Investition steht man immer einer Vielzahl von Fragen und Entscheidungen gegenüber, deren konkrete Beurteilung oftmals erst später möglich ist. Wir haben es uns darum zur obersten Devise gemacht, Ihnen ein Höchstmaß an Entscheidungssicherheit mit auf den Weg zu geben. Aus diesem Grund bieten wir unseren Gesprächspartnern die Möglichkeit, sich neben unserer umfassenden Beratung in Tuttlingen auch in Form einer Hospitation ein genaues Bild unserer Leistungen zu machen und sich mit Kollegen in anderen Kliniken fachspezifisch über alle Funktionsbereiche hinweg auszutauschen. So viel Sicherheit muss sein.





## Planung & Beratung – ein Beispiel aus der Praxis

„Bei komplexen Projekten braucht man einen vorausschauenden Partner, der bei Detailfragen das Gesamtkonzept im Auge behält ...“

**Dipl.-Betriebswirt Dr. Dr. Dirk Knüppel**

Anlass der Zusammenarbeit mit Aesculap war der Fachrichtungswechsel zwischen der Klinik Rotes Kreuz und der Klinik Maingau, beides Beleghäuser mit je ca. 30 Operateuren im Raum Frankfurt. Laut Beschluss der Aufsichtsbehörde sollten zum 01. Juli 2003 die Maingauer Orthopäden in die Rotkreuz-Klinik und die Gynäkologen sowie Urologen in die Klinik Maingau wechseln. Ziel war eine Straffung der Disziplinen je Standort – eine Forderung der Kostenträger, die beinhaltet, dass die gleichen Fachbereiche nicht mehr in beiden Kliniken vorgehalten werden dürfen. Zeitgleich mit dem Umzug stand die Eröffnung des neuen OP- und Funktionstraktes mit angegliederter ZSVA in der Rotkreuz-Klinik an.

Ein komplexes Projekt also, das die externe Unterstützung eines erfahrenen Beraters erforderlich machte. Für die Umsetzung wünschten wir uns einen vorausschauenden Partner, der auch bei Detailfragen das Gesamtkonzept im Auge behält. So kam es zu Beginn des Jahres 2002 zu ersten Gesprächen mit einem Aesculap Mitarbeiter bezüglich des anstehenden Projekts. Gemeinsam wurde zunächst das Dienstleistungsangebot von Aesculap geprüft und dann die weiteren Schritte beschlossen. Für Transparenz und Sicherheit sorgte von Beginn an ein detaillierter Liefer- und Dienstleistungsvertrag, der alle Bestandteile der Service-Leistungen von der Neulieferung der Instrumente, über die Sanierung und den Werterhalt bis hin zur Installierung von instacount®PLUS im Rahmen eines „Worst-Case-Szenarios“ enthielt. Darüber hinaus war die Bedarfs- und Kostenschätzung durch Aesculap eine wertvolle Grundlage für die Budgetplanung der Kliniken.

Beratungsbasis war eine Bestandsanalyse beider Kliniken, deren Ergebnis im Kreise der Pflegedienst- und OP-Leitungen sowie der Hygiene und der Geschäftsleitung beider Kliniken präsentiert wurde. Vor diesem

Hintergrund unterteilte Aesculap die Instrumente in beiden Häusern zunächst in drei Kategorien: veraltet (hoher Anteil an Korrosionen), reparaturbedürftig, und ohne Einschränkung wieder verwendbar. Die Reparatur und Aufbereitung älterer Instrumente wurde in Etappen organisiert, um Beeinträchtigungen im laufenden Betrieb weitestgehend zu vermeiden. Im Anschluss erfolgte die Errechnung des voraussichtlichen Zusatzbedarfes an Instrumenten und Geräten in Abstimmung zwischen Aesculap und den OP-Leitungen. Dieser Mehrbedarf resultierte einerseits aus dem Fachrichtungswechsel, um bei parallel laufenden OPs einer Disziplin genügend Instrumentarium zur Verfügung zu haben und andererseits aus dem Anspruch, innerhalb der neuen, qualitativ verbesserten ZSVA einen reibungslosen und sicheren Ablauf zu gewährleisten. Im nächsten Schritt wurden direkt am Aesculap Standort in Tuttlingen die benötigten Instrumente ausgesucht und eine neue Sieb- und Containerstruktur entwickelt, die den Bedarf beider Häuser berücksichtigt und im gleichen Zuge die teure Vorhaltung nicht benötigter Instrumente ausschließt.

„Das A und O ist eine wirtschaftliche Zusammensetzung – so viel wie nötig, so wenig wie möglich.“

Bereits in dieser Phase des Projekts wurden die positiven Effekte der Beratung durch Aesculap bei allen Beteiligten deutlich: Durch die frühzeitige Planung im Vorfeld konnten zeitliche und strukturelle Engpässe weitestgehend vermieden werden und das ohnehin verstärkt beanspruchte Personal wurde durch den Aesculap Beratungsservice während der gesamten Umstrukturierungsphase optimal entlastet. Durch die Sieb- und Containeroptimierung

Dipl.-Betw. Dr. Dr. Dirk Knüppel, Direktionsassistent der Frankfurter Rotkreuz-Krankenhäuser e. V. und Projekt-Verantwortlicher, über den Aesculap Planungs- und Beratungsservice im Rahmen des Großprojekts „Fachrichtungswechsel und OP-Neubau am RKH Frankfurt“

wurden zudem überflüssige Vorhaltekosten vermieden und die Abläufe gewannen in hohem Maße an Wirtschaftlichkeit.

Beide Kliniken haben durch den Fachrichtungswechsel ein schärferes Profil mit eindeutigen Schwerpunkten erhalten, was zu höheren Fallzahlen und einer besseren Spezialisierung führte. Die gemeinsam mit Aesculap realisierte Prozessoptimierung und Standardisierung hat hier mittelfristig zu merklichen Kosteneinsparungen geführt und spiegelt unseren Gesamtanspruch wieder, bei kalkulierbaren Kosten eine bestmögliche Behandlungsqualität anzubieten. Die Umstrukturierung in Verbindung mit dem Planungs- und Beratungsservice von Aesculap hat zudem die Anpassung an DRG-Bedingungen bei gleichzeitiger Qualitätssteigerung unterstützt.

Da alle Entscheidungen in enger Abstimmung zwischen Aesculap und den Verantwortlichen in den Kliniken getroffen wurden, gab es trotz der Komplexität des Projekts keine Informationsdefizite oder zeitlichen Verzögerungen. Umzug und Eröffnung des OP-Traktes fanden pünktlich am 1. Juli 2003 statt, wobei hervorgehoben werden sollte, dass der Aesculap Mitarbeiter hier nicht nur als Berater, sondern auch tatkräftig im wahrsten Sinne des Wortes zur Verfügung stand.



Think Economy. Think Aesculap.



Effizient arbeitet nur derjenige, der den Überblick über sein Instrumentarium behält. Einsparungen sind nur dann sinnvoll realisierbar, wenn man seinen Bestand kennt und ihn konsequent organisiert. Aber wer soll sich im Tagesgeschäft darum kümmern?

Mit der Bestandsanalyse übernimmt Aesculap als spezialisierter Dienstleister die quantitative Erfassung und qualitative Analyse des kompletten Instrumentariums – über alle Disziplinen und Produktlieferanten hinweg. Das Ergebnis ist eine objektive, detaillierte und aktuelle Dokumentation der Bestände inklusive des Wartungs-, Reparatur- und Beschaffungsbedarfs sowie der damit verbundenen Kosten.

Mit der folgenden Sieboptimierung wird der Bestand vor Ort exakt an die spezifischen Anforderungen von Indikationen und OP-Techniken angepasst. Diesem Schritt geht in der Regel ein Besuch aller Funktionsbereiche im Informations- und Beratungszentrum (IBZ) in Tuttlingen voraus. Es werden Arbeitsabläufe besprochen, neue Siebstrukturen gemeinsam konzipiert und bei Bedarf neue OP-Techniken erläutert.

Alles in allem trägt dieses Konzept zu größtmöglicher Transparenz bei, verschlankt Abläufe, eröffnet Einsparpotenziale, gibt Investitionssicherheit und ist ein wesentlicher Baustein des Qualitätsmanagements, das Ziel der Prozessoptimierung immer im Blick.



## Bestandsanalyse & Sieboptimierung – ein Beispiel aus der Praxis

Chefarzt Prof. Dr. med. Hans-Rudolf Tinneberg, Direktor des Zentrums für Gynäkologie und Geburtshilfe der Justus-Liebig-Universität Gießen und

Otto Armstroff, Abteilungsleiter Technischer Einkauf, über Ablauf und Ergebnis des Aesculap Projekts „Bestandsanalyse und Sieboptimierung in der Frauenklinik der Universität Gießen“.

### Prof. Tinneberg

„Durch die Prozessoptimierung haben unsere Mitarbeiter mehr Zeit für das Wesentliche – den Patienten und die Qualität der Behandlung ...“

Erstklassige operative Ergebnisse hängen nicht nur vom Können des Operateurs ab, sondern auch von der Qualität der verwendeten Instrumente und der Zusammenstellung der Siebe. Wir verfügen heute über eine optimal abgestimmte Siebstruktur, die in jeder Hinsicht das operative Spektrum berücksichtigt und gerade unter DRG-Bedingungen in erheblichem Maße zu mehr Wirtschaftlichkeit, einer Straffung der Ablauforganisation und nicht zuletzt zu einer hohen Ergebnisqualität beiträgt.

Die Prozessoptimierung innerhalb der Universitäts-Frauenklinik ist u.a. das Resultat einer Bestandsanalyse und Sieboptimierung, mit der wir Aesculap im Herbst 2002, nach meiner Übernahme des Direktorats der Frauenklinik, beauftragten. Mit dem Stellenwechsel kam es zu einer Verlagerung der Schwerpunkte und somit zu einer intensiveren Hinwendung zur operativen Gynäkologie. Der tägliche Umgang mit den eigenen Instrumenten war geprägt von Unzufriedenheit, so dass gemeinsam mit der Verwaltung beschlossen wurde, hier grundlegende Veränderungen vorzunehmen. Aesculap war bereits an den ersten Gesprächen beteiligt und überzeugte alle

Beteiligten mit dem Konzept einer Bestandsanalyse mit anschließender Sieboptimierung. Die Bestandsanalyse wurde von zwei speziell ausgebildeten Aesculap Mitarbeitern durchgeführt und umfasste das gesamte operative Instrumentarium. Es wurde eine detaillierte Liste aller vorhandenen Instrumente erstellt, die sowohl quantitativ für Transparenz über die Produktbestände sorgte als auch qualitativ den Zustand der Instrumente bezüglich der Abnutzung und des Wartungs- bzw. Reparaturbedarfs dokumentierte. Im Anschluss folgte auf Basis dieses Gutachtens die Analyse des Gesamtwertes sowie der Aufarbeitungs- und Ersatzbeschaffungskosten.

Nachdem nur ein geringer Prozentsatz der vorhandenen Instrumente durch Reparatur weiterhin verwendbar war, wurde mit Aesculap eine komplette Neuzusammenstellung der Siebe vereinbart. Ausgesprochen konstruktiv verlief der Besuch der Operateure bei Aesculap in

Tuttlingen. Hier konnten wir punktgenau auf unseren Bedarf abgestimmte Instrumente auswählen und zudem sogar nach unseren Wünschen speziell angefertigtes Instrumentarium bestellen. Die Siebstruktur wurde komplett überarbeitet und dem OP-Spektrum der Frauenklinik angepasst. Unübersichtliche Siebe wurden in Abstimmung mit den OP-Leitungen aufgeteilt, und Instrumente, die aufgrund veränderter OP-Techniken nicht mehr benötigt wurden, konnten aussortiert werden. Dies führt insgesamt zu einer Qualitätssteigerung, deren Niveau aufgrund eines mit Aesculap abgeschlossenen Wartungsvertrages auch mittel- und langfristig gewährleistet ist. So haben wir die Sicherheit, dass uns für anspruchsvolle Operationen jederzeit ein hochwertiges und präzises Instrumentarium zur Verfügung steht.

Die Mitarbeiter im OP profitieren von der Sieboptimierung in hohem Maße, da durch die erhöhte Übersichtlichkeit die Fehlerquote der ZSVA deutlich verringert werden konnte und durch die Verschlankeung der Abläufe mehr Zeit bleibt für das Wesentliche: den Patienten und die Qualität der Behandlung. Darüber hinaus ist auch die Verringerung der körperlichen Belastung durch Einhaltung der Sieb- und Beladegewichte nicht zu unterschätzen. Eine erhöhte Mitarbeitermotivation wurde zusätzlich durch die Schulungen erreicht, die Aesculap hier vor Ort während des Projekts durchgeführt hat. Ziel war es, die Mitarbeiter in Umgang und Pflege der Instrumente zu schulen aber auch die Bezeichnungen der Instrumente nach Autoren (Langenbeck-Haken, Metzzenbaumschere etc.) für alle verständlich zu machen und dies in den täglichen

„Wir haben die Sicherheit, dass uns für anspruchsvolle Operationen jederzeit ein hochwertiges und präzises Instrumentarium zur Verfügung steht ...“

Arbeitsprozess einfließen zu lassen. Darüber hinaus wurde eine Schulung für alle Ärzte veranstaltet, bei der Aesculap die Zusammensetzung der neuen Siebstruktur (Set-System mit zum Teil abteilungsübergreifenden Grund- und Zusatzsieben) nochmals umfassend erläuterte.

Als äußerst positiv in der Zusammenarbeit mit Aesculap ist schließlich herauszustellen, dass die Beratung zu jeder Zeit sachorientiert und nicht profitgesteuert war und ist.



Der von den Aesculap Beratern erarbeitete ausführliche Bericht der Bestandsanalyse wird auf Wunsch den verschiedenen Zuständigkeitsbereichen in der Klinik präsentiert. Gemeinsam werden die Möglichkeiten zum weiteren Vorgehen erörtert.

### Otto Armstroff

Aus der Sicht des Einkaufsleiters spielen Qualitätsaspekte ebenso eine Rolle wie wirtschaftliche Überlegungen. Das hat aber mit kurzfristigen Kosteneinsparungen nicht viel zu tun. Bezogen auf eine umfassende Bestandsanalyse und Sieboptimierung bedeutet das, vorausschauend zu planen und vor allem Komplexitäten weitestgehend zu reduzieren.

Berücksichtigt wurde bei diesem Projekt beispielsweise auch die Umstellung von einer dezentralen zu einer zentralen Sterilversorgungsabteilung innerhalb des Klinikums; hier konnten Aufbereitungskapazitäten nachhaltig gesteigert und Kosten gesenkt werden. Zudem wurde eine Verbesserung der ZSVA-Durchlaufzeiten erreicht, da sich durch die Homogenisierung der Siebinhalte und die wirtschaftliche Struktur der Siebe auch die Packzeiten verkürzten. Durch die

konsequente Auslagerung der Aufbereitung konnten diese Tätigkeiten zudem auf den Bereich der ZSVA konzentriert werden und das Personal innerhalb der Abteilung wird zu Gunsten der ihm eigentlich zugeordneten Aufgaben entlastet.

„ Unser Ziel:  
Transparenz im Sinne der  
Qualitätssicherung und Nutzung  
von Einsparpotentialen ... ”

Wirtschaftlich und im Sinne eines professionellen Qualitätsmanagements vorteilhaft ist der Umstand, dass alle unter heutigen Gesichtspunkten als bedenklich geltenden Artikel (verchromt, korrodiert) aus dem Bestand entfernt und gleichzeitig sanierungsfähige Altbestände nach der Reparatur Kosten sparend wieder in die neue Siebstruktur integriert wurden.

Heute verfügen wir über ein einheitliches Sortiment, in dem sich jedes einzelne Instrument durch seine Artikelnummer exakt identifizieren und nachverfolgen lässt – die so geschaffene Transparenz ermöglicht gerade unter DRG-Bedingungen die benötigte Präzision bezüglich der Kosten- und Budgetplanung.

Durch die gute und abteilungsübergreifende Kommunikation zwischen den Projektbeteiligten und Aesculap sowie die professionelle Arbeitsweise des Aesculap Teams vor Ort war ein störungsfreier Verfahrensablauf jederzeit gewährleistet.

Aufgrund dieses positiven Ergebnisses hat der Vorstand des Universitätsklinikums Gießen beschlossen, auch innerhalb der anderen chirurgischen Disziplinen eine Sieboptimierung durch das Aesculap Team vornehmen zu lassen.

Die Vorteile einer Sieboptimierung sind, neben einem Wissenstransfer und einer Steigerung des OP-Qualitätsmanagements die Möglichkeit, innerhalb der ZSVA die Effizienz des Mitarbeiterinsatzes zu steigern und eine Reduzierung des Aufbereitungsaufwandes zu erreichen.

### Waschen/Desinfektion

Reduzierung ...

- ... des Verbrauchs von Reinigungs- und Desinfektionsmitteln
- ... der Maschinenkapazitäten durch gezielte Aufbereitung
- ... der Wartungskosten durch reduzierten Einsatz

### Packen

Reduzierung ...

- ... der Packzeiten
- ... des Packmaterials

### Sterilisation

Reduzierung ...

- ... des Medienverbrauchs
- ... der Maschinenkapazitäten durch gezielte Aufbereitung
- ... der Wartungskosten

### Logistik

Verbesserung ...

- ... der Verfügbarkeit von Instrumenten
- ... der Wagenkapazität

### OP

Reduzierung ...

- ... der fallbezogenen Kosten
- ... der Komplexität des OP-Ablaufs  
Sicherung des OP-Qualitätsmanagements

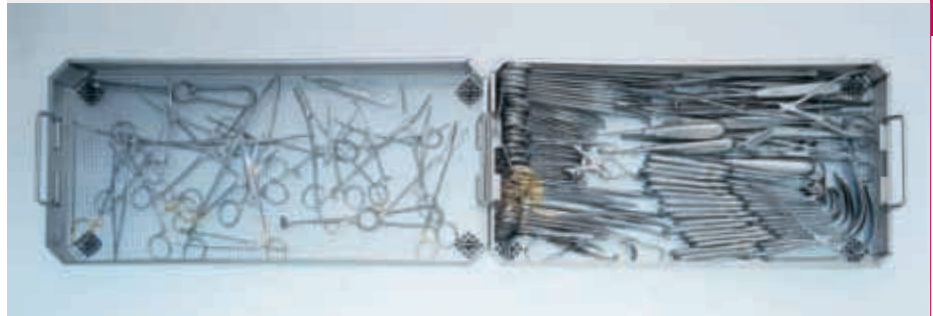

Nur die im linken Sieb befindlichen Instrumente wurden während einer OP aus dem gesamten Grundsieb benutzt. Trotzdem muss das gesamte Grundsieb mit allen Instrumenten in der ZSVA gereinigt, desinfiziert, gepackt, gepflegt und sterilisiert werden. Auf diese Weise werden Tonnen von Instrumenten unnötig aufbereitet. Eine Sieboptimierung kann die damit verbundenen Kosten deutlich reduzieren.

## Kalkulationsbeispiel zur Kostenreduzierung durch eine Sieboptimierung

Beispiel vorher „ohne Sieboptimierung“

MIC-Set + Basis-Set  
ca. 120 Instrumente

2 Sterilguteinheiten

bei einem Mittelwert von  
15 Eingriffen pro Woche

1560 Sterilguteinheiten im Jahr

Beispiel nachher „mit Aesculap Sieboptimierung“

MIC-Set + einige zusätzliche Standard-Instrumente  
ca. 45 Instrumente

1 Sterilguteinheit

bei einem Mittelwert von  
15 Eingriffen pro Woche

780 Sterilguteinheiten im Jahr

Ergebnis „mit Aesculap Sieboptimierung“ u.a.:

- ca. 50% weniger Sterilisationskapazität
- ca. 50% Packzeitreduzierung
- ca. 20 – 40% weniger Materialeinsatz
- Steigerung der Mitarbeitermotivation

## Think Partnership. Think Aesculap.

Hochwertige Werkzeuge verdienen Wertschätzung im wahrsten Sinne des Wortes. Der Instrumentenbestand einer Klinik stellt schließlich einen nicht unerheblichen Teil des Anlagevermögens dar.

Die Aesculap Qualitätsreparatur basiert daher auf den strengen Qualitätsnormen der Instrumentenherstellung und garantiert, dass Wert und Funktion jedes Instruments so lange wie möglich erhalten bleiben – mit Sicherheit. Zu Ihrem Vorteil.

Neben den geleisteten Einzelreparaturaufträgen sind Werterhaltungsverträge – insbesondere bei der Neuausstattung des OP – empfehlenswert. Die Budgetsicherheit sowie das detaillierte Reporting, welches die Prozesstransparenz erhöht und eine direkte Kostenstellenzuordnung ermöglicht, sprechen für die Aesculap Qualitätsreparatur.

Ein flächendeckendes Außendienstnetz von Aesculap Mitarbeitern und Fachhändlern stellt den zuverlässigen Service vor Ort jederzeit sicher.



Die Spezialisten vom Aesculap Technischen Service (ATS) sind darauf bedacht, den Lebenszyklus aller Instrumente zu verlängern und achten so z. B. auf einen möglichst geringen Materialabtrag beim Schleifen von Scheren. Ob schärfen, polieren, justieren oder reinigen – beim ATS geschieht alles mit einer konstanten Präzision und Sorgfalt.



Während die Aesculap Qualitätsreparatur bereits bei einfachen Standard-Instrumenten eine sinnvolle Investition darstellt, so ist sie bei hochwertigen, diffizilen Instrumenten wie z.B. einer Mikrofeder-  
schere ein unbedingtes Muss. Jede unsachgemäße Reparatur kann aus einem wertvollen Instrument schnell ein ungeliebtes Abschreibungsobjekt machen – dem automatisch eine ungeplante Ersatzinvestition folgt.



Mit jeder durchgeführten Reparatur wird die Oberfläche der Instrumente übrigens komplett überarbeitet und mit dem ATS-Siegel sowie dem Reparaturdatum versehen. Denn auf jede Qualitätsreparatur gibt es ein Jahr Garantie.

Der Aesculap Technische Service ist für Sie da: Über unsere Hotline helfen erfahrene Spezialisten dem OP-Team schnell und zuverlässig aus der Klemme. Und reparaturbedürftige Instrumente werden durch unseren Service auf Wunsch in der Klinik abgeholt und nach erfolgter Qualitätsreparatur schnellstens retourniert.



## Think Service. Think Aesculap.

Heute wird von Krankenhäusern mehr denn je wirtschaftliches Denken, effizientes Kostenmanagement sowie Rechts- und Patientensicherheit verlangt. Künftig müssen auch für das chirurgische Instrumentarium alle Abläufe klar dokumentierbar und eindeutig nachvollziehbar sein.

Damit dies zuverlässig funktioniert, bietet Aesculap seinen Kunden das Instrumenten Management System instacount®. Durch die Inventarisierung des Instrumentenbestands wird es möglich, Siebe und Instrumente über ihre gesamte Lebensdauer hinweg zuverlässig und übersichtlich in ihrem Kreislauf zu verfolgen.

Darüber hinaus können neben dem Einkaufspreis gleichermaßen die Kosten für Reparaturen und Handling pro Sieb, pro OP und pro Patient dokumentiert und entsprechend zugeordnet werden.

Neben der Systemlösung instacount® PLUS ist zudem auch eine BASIC-Version verfügbar, die sich als Plug and Play-Software einfach bedienen lässt. instacount® BASIC ist der ideale Einstieg in das Thema „EDV gestützte Dokumentation des Instrumenten Kreislaufes“, und ist ohne Probleme auf die Systemlösung instacount® PLUS zu erweitern.



### instacount®

Mit der Entscheidung für instacount® PLUS oder instacount® BASIC geben Sie Ihrem Krankenhaus ein solides Fundament für die erfolgreiche Arbeit. Das systematische und effiziente Instrumenten Management macht die Instrumentenbestände transparent und erleichtert Planung und wirtschaftliche Koordination.

Sowohl in instacount® PLUS, wie auch in instacount® BASIC können Sie einfach und schnell Ihr gesamtes Instrumentarium nach den neuesten RKI Richtlinien klassifizieren und kommen so spielend Ihrer Dokumentationspflicht nach.





## Instrumenten Management System

- Erstmalige Dokumentation und Standardisierung eines oftmals unklaren Prozesses mit vielen Schnittstellen und internen Reibungsverlusten
- Unterstützung des Aufbereitungsprozesses durch Packassistenten wie Arbeitsanweisungen und Mediaunterstützung (Bild, Ton, Video) u.v.m.
- Inventur auf Knopfdruck (Instrumente, Implantate, Verbrauchsmaterialien)
- Unterstützung der Siebstandardisierung durch frei definierbare Stammdaten mit Schablonen-Technik
- Transparenz über die erbrachten Leistungen durch aussagekräftige Produktionsstatistiken auf Artikel- und Setebene
- Verwaltung und Überwachung von Wartungsintervallen für Siebe, Sets und Artikel
- Automatische Kontrolle der Sterilitätsdauer gelagerter Siebe und Sets
- Einfaches Reparatur- und Bestellmanagement
- Automatische Kostenermittlung bei der Aufbereitung
- Ermittlung der Instrumentenauslastung
- Einzelne Sterilgut- oder Fallwagenzuordnung zum Patienten
- Zahlreiche Auswertungsfunktionen aus Patienten- und Sterilgutsicht

## PrimeLine Container

- neu konzipiertes permanentes Keimrückhaltesystem integriert in einen hochgradig thermostabilen Kunststoffdeckel
- Wirtschaftlichkeit durch einmalige Beschaffungskosten, niedrige Verbrauchskosten und „lifetime“ Funktion (5000 Zyklen validiert nach DIN EN 868, Teil 8, Anhang G)
- dem Erhalt der Sterilität während Lagerung, Transport und Sterilbereitstellung wird in vollem Umfang Rechnung getragen
- systematische Organisation des Sterilgutkreislaufes im Krankenhaus



Mit PrimeLine unterstreicht B. Braun Aesculap seine weltweit führende Position als Hersteller chirurgischer Instrumente und Sterilcontainer Systeme für die sichere und wirtschaftliche Sterilgutversorgung im Krankenhaus.

## Think Competence. Think Aesculap.

Als kompetenter Partner in der medizinischen Fort- und Weiterbildung verknüpft die Aesculap Akademie durch intelligente Netzwerke Medical Professionals in der ganzen Welt. Unter dem Dach von B. Braun bietet sie ein durch Landesärztekammern oder medizinische Institutionen qualitätsgeprüftes Programm für Mediziner, Mitarbeiter in den Funktionsbereichen, Stationen und Praxen sowie Krankenhaus Management an.

Das Aesculaprium in Tuttlingen ist Stammsitz der weltweiten Aesculap Akademie Aktivitäten. Differenzierte Schulungskonzepte werden entwickelt, die Theorie und Praxis verbinden, aufeinander aufbauen – gemäß den Richtlinien der „Continuing Medical Education“. Das vielseitige Programm umfasst indikationsbezogene Seminare, Workshops und Schulungen ebenso wie Management-Seminare.

Die Mediathek ergänzt das Fortbildungsangebot durch mehr als 270 qualitätsgeprüfte Filme der Deutschen Gesellschaft für Chirurgie. Sie dokumentieren und kommentieren OP-Techniken und chirurgische Themen nahezu jeder Disziplin.

Exzellenz in der medizinischen Fortbildung.  
Aesculap Akademie.



Innerhalb des Schulungskonzeptes ermöglicht der praxisorientierte Teil u.a. die Erprobung neuer Techniken sowie den Erfahrungsaustausch der Teilnehmer.





Fachkundefhrgange zum Sterilgutassistenten – ein Beispiel aus der Praxis

Paul-Jurgen Metten arbeitet seit 1982 in der Rheinischen Klinik fur Orthopadie in Viersen und leitet dort seit 1989 die OP- und ZSVA-Abteilung. Er absolvierte erfolgreich die Fachkundefhrgange Sterilgutversorgung I – III von November 2002 bis Dezember 2003 an der Aesculap Akademie in Tuttingen. In den Fachkundefhrgangen werden von erfahrenen Fachreferenten umfassende

Kenntnisse fur Mitarbeiter der ZSVA und der OP-Abteilung vermittelt. Die Lehrgangsinhalte reichen von der Instrumentenaufbereitung und -dokumentation uber alle Bereiche der Qualitatssicherung, der Kostenrechnung und der Personalentwicklung bis hin zur Vermittlung von rechtlichen Grundlagen, Betriebswirtschaftslehre und speziellen EDV-Voraussetzungen. Die drei Lehrgangsteile bauen aufeinander auf, fuhren aber zu selbststandigen Abschlussen. Alle Fachkundefhrgange basieren auf den Richtlinien der Deutschen Gesellschaft fur Sterilgutversorgung (DGSV).

## Auszug aus dem Angebot der Aesculap Akademie

### OP, ZSVA und Medizintechnik:

- Osteosynthesetechniken
- Endoprothetik
- Motorensysteme
- Qualitatsmanagement
- OP-Management
- Sterilcontainer/ZSVA
- ...

### Mediziner:

- Laparoskopische Abdominal-/Viszeralchirurgie
- Laparoskopische Hernienchirurgie
- Mikro-Chirurgie
- Naht-Technik-Seminar
- Laparoskopische Urologie
- Laparoskopische Gynakologie
- ...

### Einkauf und Verwaltung:

- DRGs
- Kompaktwissen Einkauf und Management
- Prozessoptimierung
- Qualitatssicherung
- Vertragsrecht
- Marketing und Vergabeordnung
- ...

„Ich habe mich fur die Ausbildung mit der Aesculap Akademie entschieden, um mich sowohl fachlich als auch personlich weiter zu qualifizieren. Naturlich hatte ich gemischte Gefuhle nach 22 Jahren im Beruf noch einmal die Schulbank ‘zu drucken’. Als jedoch die Betriebsleitung der Klinik die Kostenubernahme fur den Lehrgang zusagte und ich mich eingehend uber die Organisation und die Inhalte der Schulung informiert hatte, war ich von der Richtigkeit meiner Entscheidung uberzeugt. Unterbringung und Verpflegung waren ebenso hervorragend organisiert wie die Bereitstellung der umfassenden Arbeits- und Hilfsmittel. Bei Fragen standen die Mitarbeiter der Aesculap Akademie stets zur Verfugung. Alle Fragen wurden sofort und sachkundig beantwortet und eine konstruktive Diskussion war nicht nur wahrend der Workshops jederzeit moglich und erwunscht. Durch die standige padagogische und fachliche Betreuung haben alle Teilnehmer die Prufung bestanden – was nicht zuletzt naturlich auch den ausgewahlten Referenten, die uber eine hohe fachliche Kompetenz verfugten und die komplexen Lerninhalte verstandlich und praxisnah vermittelten, zu verdanken war.

„Man entwickelt einen Blick fur das Wesentliche und lernt, in umfassenden Zusammenhangen zu denken ...“

Im Nachhinein hat sich eindrucksvoll bestatigt, dass sich das neu erworbene Wissen mit hohem Nutzen und sprichwortlich Gewinn bringend im praktischen Berufsleben umsetzen lasst. Der Blick fur das Wesentliche wird gescharft und durch den umfassenden Unterrichtsstoff der aufeinander aufbauenden Lehrgange ist es moglich, die Zusammenhange im Krankenhaus besser zu erkennen und zu verstehen sowie Prozesse sinnvoll zu reorganisieren.

Fur mich personlich waren vor allem die Grundlagen des Qualitatsmanagements und der Zertifizierung von besonderer Bedeutung, wie auch die neuen Erkenntnisse zur Validierung von Grosterilisatoren und zur Werterhaltung von Instrumenten. Die Klinikleitung ist vom Ergebnis der Fachkundefhrgange ebenfalls so uberzeugt, dass in Zukunft alle Kolleginnen und Kollegen aus dem OP- und ZSVA-Bereich ihre Ausbildung an der Aesculap Akademie absolvieren werden.“

## Think Aesculap.

Profound knowledge derives from appreciating the significance of individual pieces of knowledge or experience and fitting them together into a coherent network. A principle B. Braun has been following consistently for more than 160 years, clearly reflected in its corporate claim: "Sharing Expertise". Sharing knowledge across all company divisions creates a broader, sounder knowledge base for everyone involved, resulting in far sighted, detailed solutions and maximum safety. For the benefit of the patient and in the interests of the user.

With over 130 years of experience in the surgical instrument sector, the Aesculap Division is a competent partner for this interdisciplinary knowledge sharing process.

The Aesculap brand represents a varied spectrum that intelligently and economically combines high quality products with process-orientated services. Aesculap is a reliable and accepted partner for the entire surgical process in the hospital.

Aesculap owes its standing among the best in the business to its employees, who, searching for the best possible solution, are never satisfied with their initial idea. Who repeatedly examine, question and optimize every development.

Thus, Aesculap is much more than a supplier of high precision surgical instruments: a partner who listens carefully and contributes ideas, who understands the customers' needs and requirements and provides for them on a high level. From products to services and seminars for all areas of activity within the hospital.



### Think Quality

### Think Partnership



- I treat contracts like a partnership: based on mutual trust and respect.

**Think Partnership.** Think Aesculap.

### Think Competence



- The Aesculap Information Center in Tuttlingen is unique. Nowhere else in the world could I advise my customers so competently and offer such choice.

**Think Competence.** Think Aesculap.



- Our instruments are held in high esteem by surgeons all over the world. I know why this is and I make sure it stays that way.

**Think Quality.** Think Aesculap.

- People I talk to can be critical at first: high quality, but still an economically sensible solution? Then I simply let the facts speak for themselves.

**Think Economy.** Think Aesculap.



Think Economy

### Think Service



- Sometimes it's the minor details we provide that make the process run smoothly. The main thing is, everything works and everyone is happy.

**Think Service.** Think Aesculap.

### Think Innovation



- Each new product is like your own baby. You lovingly take care of it until it grows up and leaves home.

**Think Innovation.** Think Aesculap.

## Think Quality. Think Aesculap.

To satisfy our own high demands as well as our users' expectations, Aesculap's quality requirements are extraordinarily high. For over 17,000 products covering practically all indications in the separate disciplines: no easy undertaking.

From the very beginning, we have set our own quality standard, severely narrowing the standard tolerances permitted by the DIN and ISO norms.

This can already be seen in the selection and inspection of the raw materials we use, and it continues throughout the entire production process.

Our manufacturing technique, a combination of high technology and precision manual work, integrated with our knowledge and expertise, enable us to produce instruments that are always true to pattern, extremely precise and of consistent high quality.

After all, at Aesculap we have known for more than 130 years that there is nothing more economical than high quality.



### ■ Quality Assurance

An essential element in our comprehensive quality management system is process integration, from the product idea through development and production to the inspected finished instrument. This includes modern manufacturing techniques and validated procedures, including systematic quality checks, to ensure that Aesculap quality remains constantly high.





■ We can only guarantee reproducible Aesculap quality over decades thanks to the technical skill, experience and care of Aesculap's surgical instrument makers. Expertise that is responsibly and conscientiously shared with others.



### Tungsten Carbide Instruments

For our instruments with tungsten carbide inserts we use only high quality nickel-bound tungsten carbide tips, well known for their high corrosion resistance and low wear.



### Hemostatic Forceps – Olive in the Jaw

The olive forms the transition from the working end or jaw to the "joint" of the instrument. This special design makes the jaw more elastic and the instrument less liable to break.



How do we ensure that every Aesculap instrument conforms exactly to the shape and dimensions of the master pattern? We inspect every single one!

## Think Innovation. Think Aesculap.

In constant dialogue with practitioners and clinical partners, Aesculap designs and creates instruments for all surgical disciplines – frequently setting the trend. A team of 200 people around the world is employed in research and development into new, economically viable solutions to provide the best patient care.

The essential focus is not on what is possible technologically, but on what makes sense medically. Sensible developments for us mean instruments that function in such a way that they decisively and positively influence the course of a surgical operation, whilst not losing sight of economic considerations. For example:



### BipoJet Bipolar Dissecting Scissors for Open Surgery

BipoJet makes it possible to dissect, cut and coagulate in one step. For the surgeon, using BipoJet means that he or she can work more quickly, safely and efficiently. Innovative manufacturing technologies, such as the solid ceramic insert in the scissor blade and the PEEK synthetic coating ensure long life and safe electrical operation. For the hospital, efficiency, safety and long life represent an important economic advantage.



### Münster Retraction System

The Münster Retraction System, now a byword for versatility, flexibility and stability in abdominal surgery, has been further developed to include a new open frame that can be quickly and easily adjusted into any position in three planes thanks to an innovative joint technology. This gives the user more freedom of action and further enhances the system's capacity to adapt to the individual operating situation.



### Micro Instruments For Cardiovascular Surgery

Manufactured through latest production technologies, from selected materials, for outstanding functionality. The jaw working surfaces of needle holders and forceps are finished with Aesculap DIADUST diamond dust coating. The result: a hard and hard-wearing working surface. DIADUST coating ensures a reliable grip on fine needles and soft tissue.

## Joint Development of BipoJet,



Aesculap cooperates closely with users in the development of new surgical instruments and the further development of existing products. This enables us to create high quality products that set new standards and satisfy the surgeons' wishes and requirements down to the last detail. Valuable synergies and outstanding projects flow from this collaboration between Aesculap specialists and experienced users, resulting time and again in trendsetting innovations in surgical instruments.

Aesculap development projects are conducted within a tightly designed project management system to ensure transparency and efficiency.





## a Practical Example



Prof. Dr. med. Gottfried Müller is the Medical Superintendent of the Surgery Clinic in the Bad Mergentheim Charity Hospital, and has played a decisive role in the development of Aesculap surgical instruments for over 20 years.

More than 20 years of successful and enjoyable cooperation with Aesculap on a large number of project ideas means for me friendly and confident listening, discussions based on a thorough knowledge of the subject, accurate project research and programming in categories such as "innovation, feasibility, market expectation, function, ergonomics, material, quality, production, research, testing, functionality, safety, reliability, clinical controls, practicability, cost effectiveness, system suitability and market acceptability". All these headings lie behind projects that were and are interesting for me.

But Aesculap also means for me personal association with interesting people who bring their experience and strength

into many different contacts: engineers, technicians, secretaries, business managers, doctors and developers, many creative men and women from all professions.

For me, knowing Aesculap means having an insight into a large and serious entity whose task is to provide products for medicine – things that are directly to do with us as surgeons. Against this background, Aesculap is a name that every surgeon knows. Behind the name I see people at desks and workbenches putting all their commitment into cooperative projects; projects that will help to define my future in medicine.

The latest example of this is the joint development of BipoJet.

Dr. med. Albert Linder is Chief Consultant in the Thoracic Surgery Department in the Hemer Lung Clinic, and is convinced of the value of input from daily practice into the development of products to benefit daily practice. For more than 10 years, Dr. Linder has been working closely with Aesculap as a clinical adviser.

"The development of the BipoJet scissor is an outstanding example of how users' ideas originating from their daily practice in the operating theatre can become a high tech product ready for the market in a very short time. With Aesculap, this is done in excellent cooperation between the surgeon and the development team, and always on site, either in the operating theatre or in the workshop."



Think Competence. Think Aesculap.



Project consultation in the Aesculap Information Center in Tuttlingen involving representatives from all hospital departments.

The question of investing into surgical techniques has been made much more difficult and controversial by the constant changes in the healthcare market and by the introduction of DRGs and total quality management – once made, wrong decisions are extremely hard to put right.

The Aesculap project planning team of specialists with know-how and operational expertise supports hospitals and clinics in planning large or small projects and implements them expertly, reliably, and on time. All over the world.

The team cooperates with architects, technicians, doctors, nurses and hospital managers in analysing procedures, establishing needs and creating the necessary conditions for process optimization. The result is sound and effective project management from A to Z. Whether the task is to equip a new hospital or to build up a new discipline.

### ■ Information Visits

When planning an investment, you are faced with many questions and decisions that can often only be properly assessed afterwards. This is why we have made it our guiding principle to give you the greatest possible certainty in your decision-making. We offer our discussion partners the opportunity to form an exact picture of what we can provide, not only through our comprehensive consultation service in Tuttlingen, but also in the form of information visits, where you can have the chance to talk with colleagues in other hospitals on topics relating to all areas of activity. Everything to provide you with a sound basis for a confident decision.



## Planning and Consulting – a Practical Example

"For complex projects you need a partner with vision, who keeps the overall concept in view when dealing with the details ..."

■ Dr. Dr. Dirk Knüppel

"The collaboration with Aesculap was brought about by the discipline swap between the Red Cross Clinic and the Clinic Maingau, both in-patient hospitals in the Frankfurt area with approximately thirty surgeons each. The supervisory authority had decided that the orthopaedic surgeons from Maingau should move to the Red Cross Clinic and that the gynaecologists and urologists from the Red Cross Clinic should move to Maingau by July 1st, 2003. The objective was to streamline the disciplines at each site, complying with the sponsors' demand that the same disciplines should no longer be available at both hospitals. This move was to coincide with the opening of a new operating theatre and functional wing in the Red Cross Clinic, incorporating a CSSD.

A complex project, that required external support from experienced consultants. To implement it, we were looking for a partner with vision, who would keep the overall concept in view when dealing with the details. And so, at beginning of 2002, we began discussions on the project with a consultant from Aesculap. We first looked together at the services Aesculap could offer before deciding what steps to take next. A detailed delivery and service contract – which in a worst-case scenario covered every element in the service package from the delivery of new instruments, refurbishment and value preservation to the installation of instacount®PLUS – ensured transparency and security right from the beginning. In addition, the assessment of requirements and cost estimate supplied by Aesculap provided a valuable basis for the hospitals' budget planning.

The consultation was based on an Inventory Analysis in both hospitals, the results of which were presented to the heads of nursing, surgery and hygiene and to the business directors. Aesculap began by

sorting the instruments from both hospitals into three categories: obsolete (high degree of corrosion), in need of repair, and still usable. Repair and refurbishment of the older instruments was organized in stages to avoid disrupting the everyday work of the departments affected more than was absolutely necessary. The next step was for Aesculap and the surgery managers to agree on the additional instruments and equipment required. On the one hand, this additional requirement was a result of the discipline swap, since enough instruments had to be available to carry out parallel operations in the same discipline. On the other hand, it arose from the need for the new, qualitatively enhanced CSSD to operate safely and smoothly. The instruments required were subsequently selected at the Aesculap headquarters in Tuttlingen and a new instrument set and container structure was developed, taking the needs of both clinics into account and excluding instruments that were no longer needed, thus saving the hospitals the expense of storing and maintaining them.

**"It is all about finding the right economic combination – as many instruments as necessary, as few as possible"**

At this stage of the project, the positive effects of Aesculap's consulting service were already becoming obvious to everybody concerned: early planning in the preparation stage helped to avoid timing and organizational bottlenecks to a great extent. During the entire restructuring phase the Aesculap consulting service offered the best possible support for staff already under additional pressure. Furthermore, the set and container optimization service saved unnecessary

Dr. Dr. Dirk Knüppel, MBA, Assistant to the Board of the Frankfurter Rotkreuz-Krankenhäuser e. V. and project director, talking about the Aesculap planning and consulting service in the context of the major project "discipline swap and new operating theatre at the RKH in Frankfurt"

costs for storing and maintaining redundant instruments and the procedures became much more economical.

Through the discipline swap, both hospitals gained a sharper profile with clear priorities, leading to higher case turnover and improved specialization. The optimization and standardization of processes we have achieved in collaboration with Aesculap has brought considerable cost savings in the medium term, and reflects our overall objective to offer the best possible quality of treatment at calculable costs. In addition to this, the restructuring, combined with the planning and consulting service provided by Aesculap, has helped us to adapt to DRG requirements while at the same time enhancing the quality of provision.

Since all decisions were taken in close consultation between Aesculap and the respective hospital managers, there were no information gaps and no delays. The discipline swap and the opening of the new operating theatre wing took place on time on July 1st, 2003, and here it should be emphasized that our partner from Aesculap did not just attend as a consultant, but took an active part in the proceedings in the truest sense of the word.



Think Economy. Think Aesculap.



You cannot work efficiently if you do not maintain the overview of your instrument stocks. It is only by knowing what instrumentation you have and by organising it logically and consistently that you can make real savings.

But who is going to take care of that in the day to day work in the hospital?

In its Inventory Analysis program, Aesculap, as a specialist service provider, makes a quantitative record and a qualitative analysis of the entire instrument stock – covering all disciplines and including all product suppliers. The result is an objective, detailed and up to date documentation of the hospital's stocks, including maintenance, repair and purchasing requirements together with the associated costs.

This is followed by Set Optimization, where the contents of the hospital's instrument sets are reorganized on site to comply exactly with the specific requirements of different indications and operating techniques. The working procedures in the hospital are discussed, a new concept for instrument sets is jointly worked out and new operating techniques can be explained if required.

All in all this concept contributes to maximum transparency, slims down procedures, opens up savings potential, provides security for investment planning and forms an essential component in quality management, with the goal of process optimization always in view.



## Inventory Analysis and Set Optimization – a Practical Example

Prof. Dr. med. Hans-Rudolf Tinneberg, Medical Superintendent and Director of the Center for Gynaecology and Obstetrics at the Justus Liebig University, Giessen (Germany), and

Otto Armstroff, Head of Technical Purchases, talking about the development and outcome of the Aesculap project "Inventory Analysis and Set Optimization at the gynaecological clinic of Giessen University".

adapted to the range of operations performed at the gynaecological clinic. In agreement with the operating theatre managers, large sets where individual instruments could not be easily identified were divided up and instruments that changes in operating techniques had made obsolete were set aside. This led to an overall increase in the quality of our instrumentation, which will be ensured in the medium and long term through the maintenance contract we have concluded with Aesculap. In this way, we can be certain of having high quality and precise instrumentation always available for demanding operations.

The theatre staff have greatly benefitted from the optimization, since the clearer set contents have significantly reduced the error rate in the CSSD and the streamlined processes leave more time for the essentials: the patient and the quality of treatment. The reduced physical strain for staff through strict controls on set and load weights should also not be underestimated. The training sessions conducted on site by Aesculap during the project provided an additional boost to staff motivation. The aim was to train the staff in the handling and care of the instruments, and also to help them understand the instrument names that refer to the original authors (Langenbeck hooks, Metzenbaum scissors etc.) and introduce these names into the daily routine. In addition to this, a training session was also provided for the surgeons, where Aesculap again gave a thorough explanation of how the new set structure was organized (set system with some interdepartmental basic and supplementary sets).

### Prof. Tinneberg

"Optimising our processes has given our staff more time for the essentials – the patient and the quality of treatment ..."

Excellent surgical results depend not only on the skills of the surgeon, but also on the quality of the instruments used and on the composition of the instrument sets. Now we have a set structure that is optimally adapted to our requirements, that takes full account of the spectrum of operations we perform and that substantially contributes to greater economy, streamlined processes and, last but not least, better results.

The optimized processes within the university's gynaecological clinic are partly the result of an Inventory Analysis and Set Optimization service that we commissioned from Aesculap in the autumn of 2002, after I had taken over as director of the clinic. The change in directorship led to a shift of emphasis towards operative gynaecology. We were generally dissatisfied with our own instruments in our everyday work, and so, in agreement with the hospital management, we decided to embark on fundamental changes. Aesculap was already involved in the initial discussions and convinced all participants of the merits of the Inventory Analysis and subsequent Set Optimization concept. The Inventory

Analysis was carried out by two specially trained Aesculap technicians and covered the entire range of surgical instruments. A detailed list of all instruments was compiled, providing transparency in the quantity of instruments in the clinic and documenting their quality and condition with regard to wear and tear and the need for refurbishment or repair. On the basis of this report, the overall value of the instrument stock and the repair and replacement costs were analysed. As only a small percentage of the existing instruments could be repaired to make them suitable for further use, we agreed with Aesculap to put together a completely new collection of instrument sets.

The surgeons' visit to Aesculap in Tuttlingen was extremely constructive. There we could choose instruments that matched our requirements down to the last detail, and even order special instruments custom-made to our wishes. The instrument set structure was completely optimized and

"...we can be certain of having high quality precise instrumentation always available for demanding operations..."

## Think Economy. Think Aesculap.

An extremely positive aspect of our collaboration with Aesculap should be emphasized: the consultation process was, and remains, at all times subject-related, objective and never profit-orientated.



If desired, the Aesculap consultants' detailed Inventory Analysis report can be presented to representatives from the various areas of responsibility within the hospital and the possibilities for further action explored in joint discussions.

### Otto Armstroff

From my perspective as head of purchasing, quality aspects are just as important as economic considerations. But this has very little to do with short term cost savings. In relation to a comprehensive Inventory Analysis and Set Optimization, this means planning a long way ahead and above all reducing complexities to the minimum.

For instance, we included in the project the changeover from a decentralized to a Central Sterile Supplies Department in the hospital, which allowed us to achieve lasting capacity gains in instrument reprocessing and to reduce costs. CSSD throughput times were also improved, since the homogenization of the set contents and the economical organization of the sets shortened the necessary packing times. Strict outsourcing of reprocessing meant

that all these activities were concentrated within the CSSD, releasing other staff for their intended tasks.

#### "Our goal:

to create transparency in the sense of quality assurance and to realize savings potential"

One important advantage of the process, both economically and in terms of professional quality management, is the fact that all instruments that nowadays have to be regarded as of dubious value (chromium-plated, corroded) were removed from our stocks, while old instruments that could be repaired or refurbished were subsequently re-integrated into the new set structure, leading to further cost savings. We now have a standardized

selection of instruments, each of which can be identified and traced by its article number. This level of transparency gives us the accuracy we need for our cost and budget planning, especially under DRG conditions.

The good interdepartmental communication between the project participants and Aesculap and the professional attitude of the Aesculap team during their work in the hospital ensured trouble-free progress at all times. Because of this positive outcome, the Giessen University Hospital Board has decided to commission Aesculap to carry out its Set Optimization service in the other surgical disciplines as well.

The advantages of Set Optimization, in addition to knowledge transfer and enhanced quality management in the operating theatre, are the possibility to enhance staff efficiency and to reduce reprocessing costs in the CSSD.

### Washing/Disinfecting

Reduction in ...

- ...the use of cleaning agents and disinfectants
- ...machine capacity requirements through restricting reprocessing to instruments actually needed
- ...maintenance costs through lower usage

### Packing

Reduction in ...

- ...packing times
- ...packing material

### Sterilization

Reduction in ...

- ...use of consumables
- ⌘ ...machine capacity requirements through restricting reprocessing to instruments actually needed
- ⌘ ...maintenance costs

### Logistics

Improvement in ...

- ⌘ ...instrument availability
- ⌘ ...trolley capacities

### Operating Theatre

Reduction in ...

- ⌘ ...case-related costs
- ⌘ ...complexity of theatre procedure



From the entire contents of the general instrumentation set, only the instruments in the tray on the left were actually used during an operation. In spite of this, the entire set of instruments had to be washed, disinfected, given general maintenance and sterilized in the CSSD. Tons of instruments are unnecessarily reprocessed in this way.

Set Optimization can substantially reduce the associated costs.

### Sample Calculation of Cost Reduction Following Set Optimization

Before Set Optimization:

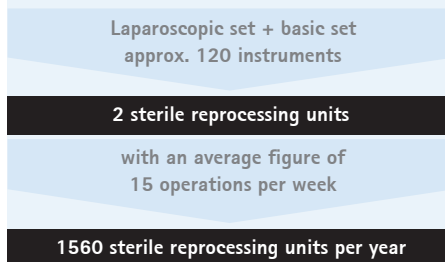

After Set Optimization by Aesculap:

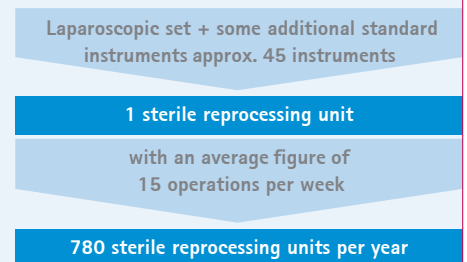

Just some of the results of Aesculap Set Optimization:

- ⌘ approx. 50% less sterilization capacity required
- ⌘ approx. 50% reduction in packing times
- ⌘ approx. 20 – 40 % less use of materials
- ⌘ improved staff motivation

## Think Partnership. Think Aesculap.

High quality instruments deserve to be valued in the truest sense of the word. After all, the instrument stock represents no small proportion of a hospital's total assets.

For this reason, the Aesculap quality repair is based on the same strict quality standards we apply to instrument production. This guarantees that the value and function of each instrument is maintained for as long as possible – safely and surely. To your advantage.

In addition to carrying out individual repair orders, we think that contracts to maintain the value of the instrument stock are to be recommended – especially when equipping a new operating theatre. Secure budgeting and detailed financial reporting, increasing process transparency within the hospital and allowing costs to be directly allocated to cost centres, speak for the Aesculap quality repair.

A blanket network of Aesculap sales representatives and distribution partners ensures reliable service on site at all times.



■ The aim of the Aesculap Technical Service (ATS) specialists is to lengthen the useful life of all instruments. They are careful, for instance, to remove as little material as possible when re-grinding scissors. Whether sharpening, polishing, adjusting or cleaning – in the ATS everything is always done with the same precision and care.





■ The Aesculap quality repair already represents a sensible investment for simple standard instruments. For high value, difficult instruments such as micro spring scissors it is an absolute must. Every incorrect or inadequate repair can quickly turn a valuable instrument into a useless write-off – automatically resulting in an unplanned investment in order to replace it.



After every repair, the surface of the instrument is completely refurbished and labelled with the ATS seal and the repair date.

The Aesculap Technical Service is there for you: experienced specialists help surgical teams out of their difficulties swiftly and reliably via our hotline. If desired, our collection and delivery service will pick up instruments for repair from the hospital and return them as quickly as possible after the quality repair has been carried out.



## Think Service. Think Aesculap.

Today more than ever before, hospitals are being required to think economically and manage their costs efficiently, as well as to ensure their own legal security and the safety of their patients. In future, all processes involving surgical instrumentation will also need to be clearly documented and fully accountable.

To make sure this functions reliably, Aesculap offers its customers the instacount® Instrument Management System. Making an inventory of the instrument stock allows the circulating sets and instruments to be traced clearly and reliably throughout their lifetime.

Moreover, as well as the instrument purchase price, the repair and handling costs per set, per operation and per patient can also be documented and allocated accordingly.

In addition to the instacount®PLUS system solution, a BASIC version is now available as an easy to use plug and play software option. instacount®BASIC offers the ideal entry into computer assisted documentation of the instrument cycle, and can be expanded into the instacount® PLUS system solution without any difficulty.



### instacount®

Deciding on instacount®PLUS or instacount®BASIC gives your hospital a solid foundation for successful working. Systematic and efficient Instrument Management creates transparency in your instrument stocks and makes planning and economic coordination easier.



## Instrument Management System

- ⌘ makes it possible for the first time to document and standardize a process
- ⌘ improves clarity, system management and optimization
- ⌘ supports sterile reprocessing with package assistants such as working instructions and media support (picture, sound, video) etc.
- ⌘ inventory at the touch of a button (instruments, implants, consumables)
- ⌘ assists the standardization of sets through freely definable master data with template technology
- ⌘ provides transparency in tasks performed through informative production statistics on the product and set level
- ⌘ controls and monitors the servicing intervals for trays, sets and individual products
- ⌘ control automatic the sterility dates for trays and sets in storage
- ⌘ manages simpler repairs and ordering
- ⌘ calculates automatically costs for reprocessing
- ⌘ establishes instrument utilization
- ⌘ allocates individual the sterile goods or case trolleys to patients
- ⌘ runs numerous analysis functions by patient or sterile goods

## PrimeLine Containers

- ⌘ newly designed permanent sterile protection system integrated into a high quality thermostable plastic lid
- ⌘ economical: one-off purchasing costs, low consumable costs and "lifetime" function (5000 sterilization cycles validated in conformance with DIN EN 868, Part 8, Annex G)
- ⌘ Maintenance of sterility fully assured during storage, transport and sterile preparation for use
- ⌘ systematic organization of the sterile goods cycle in the hospital



With PrimeLine, B. Braun Aesculap underlines its position as world leader in the manufacture of surgical instruments and sterile container systems for the safe and economical supply of sterile goods in the hospital.

## Think Competence. Think Aesculap.

As a competent partner in medical training and education, the Aesculap Academy uses intelligent networks to link up medical professionals all over the world. The quality of the program that the Academy offers for medical professionals, workers in specialist departments, wards and surgeries as well as for hospital management staff, all under the roof of B. Braun, is inspected and approved by the German state chambers of physicians or other medical bodies.

The Aesculapium in Tuttlingen, Germany, forms the headquarters for the Aesculap Academy's international activities. Differentiated training concepts have been developed, combining theory and practice and building one upon the other – in accordance with the guidelines for "Continuing Medical Education". The varied program includes indication-related seminars, workshops and training courses as well as management seminars.

The Mediathek supplements the training program with more than 270 approved quality films from the German Surgery Association. These document and comment on operating techniques and surgery topics from practically every discipline.

Excellence in medical training.  
Aesculap Academy.



The practice-orientated component in the training concept allows participants to try out new techniques and exchange experience.





### Specialist training courses to become a Sterile Processing Technician – a practical example

Paul-Jürgen Metten has been working in the Rhine Clinic for Orthopaedics in Viersen since 1982, and has been in charge of the Surgery and CSSD Department there since 1989. Between November 2002 and December 2003 he successfully completed Specialist Training Courses I – III in Sterile Goods Supply at the Aesculap Academy in Tuttlingen. In these courses, CSSD

and surgery staff are given comprehensive knowledge by experienced tutors. The course contents range from instrument reprocessing and documentation, all aspects of quality assurance, cost accounting and personnel development to basic legal knowledge, business management and specific IT requirements. The three course modules build on each other, although each concludes with an independent qualification. All specialist training courses are based on the guidelines of the Deutsche Gesellschaft für Sterilgutversorgung (DGSV), the German Society for the Supply of Sterile Goods.

## A Selection from the Aesculap Academy's Training Programme

### Surgery, CSSD and Medical Technology:

- Osteosynthesis techniques
- Arthroplasty
- Motor systems
- Quality management
- Surgery management
- Sterile containers/CSSD
- ...

### Doctors:

- Laparoscopic abdominal and visceral surgery
- Laparoscopic hernia surgery
- Microsurgery
- Suture techniques seminar
- Laparoscopic urology
- Laparoscopic gynaecology
- ...

### Purchasing and Hospital Management:

- DRGs
- Compact Purchasing and Management course
- Process optimization
- Quality assurance
- Contract law
- Marketing and order placement
- ...

"I decided on training with the Aesculap Academy in order to extend my qualifications both professionally and personally. Of course, I had mixed feelings about "going back to school" after 22 years in a job. However, after the management of the Clinic had agreed to pay the cost of the course and I had informed myself in detail about the organization and the content of the training program, I was convinced that I had made the right decision. The organization of accommodation and catering was as excellent as the provision of comprehensive learning and support material. The Aesculap Academy staff were always on hand to answer any questions, which they did immediately and expertly. Constructive discussion was possible and indeed invited at all times, and not only during the workshops. Thanks to the constant support of the teaching and technical staff, all the participants passed the examination. Thanks are also due of course to the specially selected tutors, who possessed a high degree of competence in their subject and who managed to convey the complicated contents of the course in an understandable and practical way.

"You develop a view for the essential, and learn to think in terms of connections...."

Looking back, I am impressed by the way in which my newly acquired knowledge can be translated into my daily professional activities to great advantage to myself and to the hospital. You develop a sharper view for the essential, and the comprehensive teaching material in the courses enables you to recognize and understand the connections that exist within the hospital, as well as teaching you how to reorganize processes sensibly.

For me personally, learning the basics of quality management and certification was particularly important, as was the knowledge I acquired about the validation of large sterilizers and preserving the value of surgical instruments. The clinic management is also so convinced by the result of the training courses that in future all colleagues working in surgery and CSSD departments will attend training courses at the Aesculap Academy."

## Inhaltsübersicht - Table of Contents

Seiten  
Pages

AC/AD



Untersuchung-Diagnostik, Vorbereitung  
Examination-Diagnostic, Preparation

1-20

BA



Sterilskalpelle, Skalpelle, Messer  
Sterile Scalpels, Scalpels, Knives

21-36

BB



Skalpellklingen und Griffe  
Scalpel Blades and Handles

37-46

BC



Scheren  
Scissors

47-136

BD



Pinzetten  
Dissecting- and Tissue Forceps

137-182

BF



Korn- und Tupferzangen, Waschzangen, Tuchklemmen  
Sponge- and Dressing-Forceps, Washing Forceps, Towel Clamps

183-208



## Inhaltsübersicht - Table of Contents

Seiten  
Pages

209-242

Arterienklemmen, Bulldogklemmen,  
Gefäßclipse, Approximatoren  
Hemostatic Forceps, Bulldog Clamps,  
Vessel Clips, Approximators



BH

243-274

Präparier- und Ligaturklemmen, Hysterektomieklammern  
Dissecting- and Ligature Forceps, Hysterectomy Clamps



BJ

275-280

Nähnadeln, Nadeldosen  
Surgical Needles, Needle Cases



BL

281-340

Nadelhalter, Naht-Instrumente,  
Unterbindungsnadeln und Hohlsonden  
Needle Holders, Suture Instruments,  
Ligature Needles, Guiding Probes



BM

341-354

Sonden, Watteträger, Wundklammern  
Probes, Cotton Applicators, Suture Clips



BN

355-454

Wundhaken  
Wound Retractors



BT

## Inhaltsübersicht - Table of Contents

Seiten  
Pages

BV



Wundspreizer, Bauchdeckenhalter  
Self-Retaining Retractors, Abdominal Retractors

455-504

GK



Elektrochirurgie  
Electrosurgery

505-536

EA



Abdominale Chirurgie, Magen-, Darm- und Rektum-Instrumente  
Abdominal Surgery, Intestinal- and Rectal Instruments

537-588

EB



Instrumente für Galle, Leber und Milz  
Gall Bladder-, Liver- and Spleen Instruments

589-606

EF



Urologie-Instrumente  
Genito-Urinary Instruments

607-632

EJ



Trokare  
Trocars

633-634





## Inhaltsübersicht - Table of Contents

Seiten  
Pages

635-660

Scheidenspekula  
Vaginal Specula



EL

661-668

Uterus-Dilatatoren  
Uterine Dilators



EM

669-694

Uterussonden, Tampon-, Haken-, Uterusfasszangen  
Uterine Probes, Uterine Dressing-,  
Tenaculum and Uterine Elevating Forceps



EO

695-718

Biopsie- und Kürettage-Instrumente  
Biopsy Instruments and Curettes



ER

719-736

Geburtshilfe  
Obstetrics



ET

737-890

Herz-, Thorax- und Gefäß-Chirurgie  
Cardiovascular- and Thoracic Surgery



FB

## Inhaltsübersicht - Table of Contents

Seiten  
Pages

FF



Knochenstanzen, Rongeurs  
Bone Punches, Rongeurs

891-914

FH



Amputation  
Amputation

915-926

FK



Knochenhebel, Elevatorien,  
Raspatorien, Scharfe Löffel  
Bone Levers, Periosteal Elevators,  
Bone Curettes

927-990

FL



Hämmer, Meißel  
Mallets, Chisels and Gouges

991-1012

FO



Knochenhaltezangen, Hohlmeißelzangen,  
Knochensplittierzangen  
Bone Holding Forceps, Bone Rongeurs,  
Bone Cutting Forceps

1013-1050

LX



Drahtextension, Handbohrapparate, Ahlen, Pfieme  
Wire Extension, Hand Drills, Awls

1051-1080



## Inhaltsübersicht - Table of Contents

Seiten  
Pages

1081-1088

Gips-Instrumente  
Plaster Instruments



LX

1089-1106

Sauginstrumente  
Suction Instruments



GF

1107-1110

Nierenschalen, Laborschalen  
Kidney Trays, Bowls



JG

1111-1116

Instrumentenpflege, Reinigungshinweise  
Care and Maintenance of Instruments



JG

1117-1143  
1144-1169  
1170-1196

Alphabetischer Index  
Alphabetical Index  
Numerischer Index  
Numerical Index

A - Z  
0 - 9

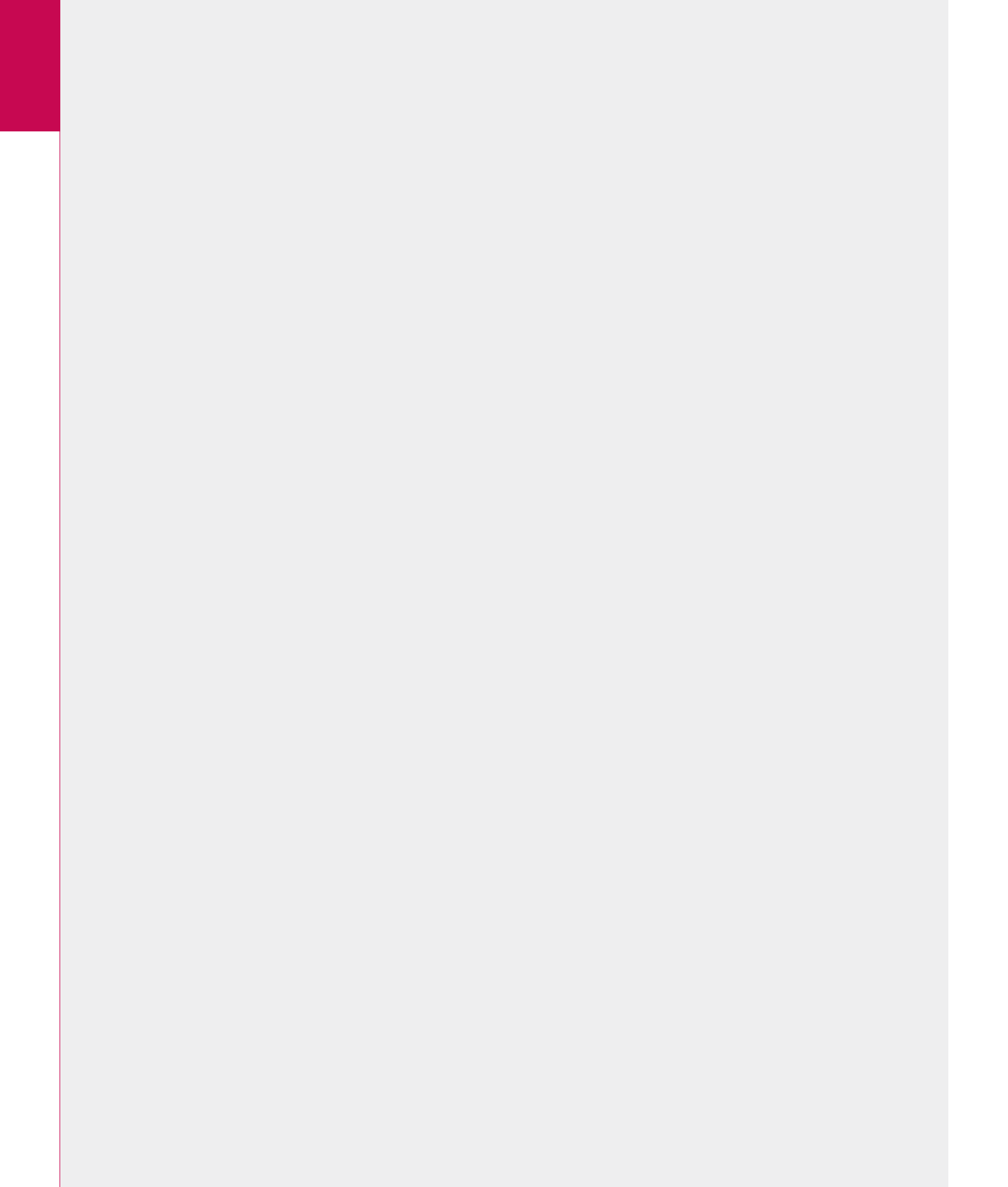

AC/AD



Untersuchung-Diagnostik, Vorbereitung  
Examination-Diagnostic, Preparation

## Untersuchung – Diagnostik – Examination – Diagnostic

### Reflexspiegel und Stirnbänder Head Mirrors and Head Bands

AC



ZIEGLER

**AC402**

Stirnspiegel allein, mit Gummifassung  
Head mirror only, with rubber coating



ZIEGLER

**OF090**

Stirnspiegel allein, mit Metallfassung  
Head mirror only, with metal coating



ZIEGLER

**AC413**

Stirnband aus Plastik, schwarz, allein  
Head band of plastic, black, only

**AC414**

Stirnband aus Plastik, weiß, allein  
Head band of plastic, white, only



MURPHY

**AC415**

Stirnband aus Celluloid, weiß, allein  
Head band of celluloid, white, only



**AC416**

Stirnband aus Plastik, weiß,  
allein, weiches Modell  
Head band of plastic, white,  
only, soft pattern



**AC421**

Stirnspiegel (AC402)  
mit schwarzem Plastikband (AC413)  
Head mirror (AC402)  
with black plastic head band (AC413)





# Untersuchung – Diagnostik – Examination – Diagnostic

## Stirnlampen Head Lights

AC



**AC440**

220 Volt  
Transformator  
220 volts  
Transformater



CLAR 55

**AC461**

Stirnlampe, 6 Volt, mit verstellbarem Gelenk, weißem Stirnband aus Celluloid mit Schaumgummipolsterung und Kabel mit Zwischenstecker zum Trafo AC440

Head light, 6 volt, with adjustable joint, white celluloid head band, with foam rubber pad and cord with plugs for transformer AC440

**AC462**

Reflektor, allein, für Stirnlampe AC461  
Mirror, only, for head light AC461

**AC464**

Ersatz-Schaumgummipolsterung für Stirnband AC454  
Spare foam rubber pad, for head band AC454



**AC463**

Ersatzbirnchen  
Spare bulb

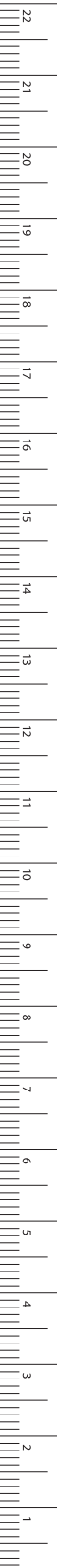

Untersuchung – Diagnostik – Examination – Diagnostic

Zungenspatel

Tongue Depressors

AC



**OM202R**

145 mm, 5 3/4"



**OM203R**

140 mm, 5 1/2"



**BUCHWALD**

**OM205R**

180 mm, 7"

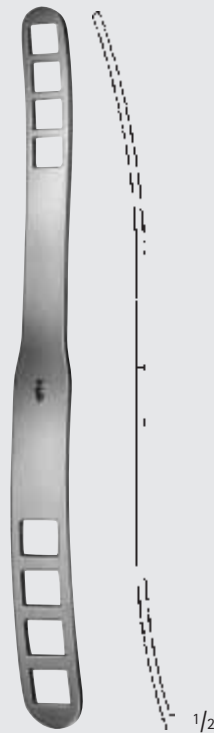

**BRUENINGS**

**OM208R**

190 mm, 7 1/2"







# Untersuchung - Diagnostik - Examination - Diagnostic

## Kehlkopfspiegel Laryngeal Mirrors

AC



**OM078R/  
AC468R**

Fig. 000  
Ø 6 mm  
diam. 6 mm



**OM079R/  
AC469R**

Fig. 00  
Ø 8 mm  
diam. 8 mm



**OM080R/  
AC470R**

Fig. 0  
Ø 10 mm  
diam. 10 mm

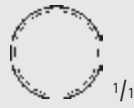

**OM081R/  
AC471R**

Fig. 1  
Ø 12 mm  
diam. 12 mm



**OM082R/  
AC472R**

Fig. 2  
Ø 14 mm  
diam. 14 mm



**OM083R/  
AC473R**

Fig. 3  
Ø 16 mm  
diam. 16 mm



**OM084R/  
AC474R**

Fig. 4  
Ø 18 mm  
diam. 18 mm

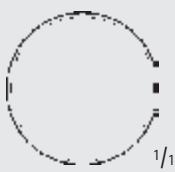

**OM085R/  
AC475R**

Fig. 5  
Ø 20 mm  
diam. 20 mm

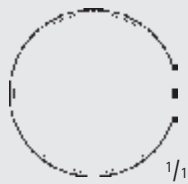

**OM086R/  
AC476R**

Fig. 6  
Ø 22 mm  
diam. 22 mm

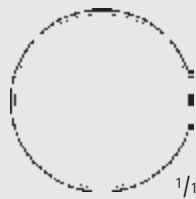

**OM087R/  
AC477R**

Fig. 7  
Ø 24 mm  
diam. 24 mm

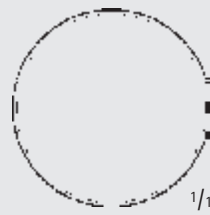

**OM088R/  
AC478R**

Fig. 8  
Ø 26 mm  
diam. 26 mm

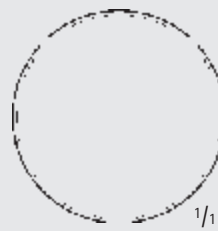

**OM089R/  
AC479R**

Fig. 9  
Ø 28 mm  
diam. 28 mm

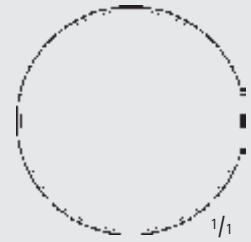

**OM090R/  
AC480R**

Fig. 10  
Ø 30 mm  
diam. 30 mm



**OM078R-  
OM090R**

Kehlkopfspiegel  
mit Sechskantgriff  
Laryngeal mirrors  
with hexagonal handle  
180 mm,  
7"



**AC468R-  
AC480R**

Kehlkopfspiegel  
Laryngeal  
mirrors  
120 mm,  
4 3/4"



**AC481R**

Spiegelgriff  
Mirror  
handle  
110 mm,  
4 3/8"



**AC483C**

Spiegelgriff  
Mirror  
handle  
105 mm,  
4 1/8"

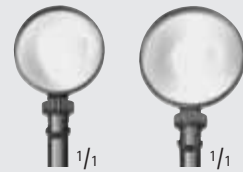

**AC497R**

Ø 12 mm  
diam.  
12 mm

**AC498R**

Ø 14 mm  
diam.  
14 mm

MICHEL

**AC497R/  
AC498R**

Rhinoskopspiegel  
Rhinoscopic mirrors  
250 mm, 10"

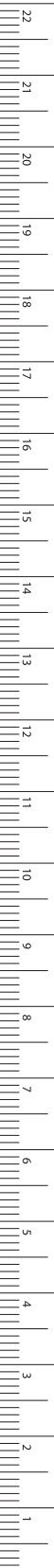

# Untersuchung – Diagnostik – Examination – Diagnostic

## Stimmgabeln

### Tuning Forks

AC



HARTMANN

- OF001N = c 128
- OF002N = c<sup>1</sup> 256
- OF003N = c<sup>2</sup> 512
- OF004N = c<sup>3</sup> 1024
- OF005N = c<sup>4</sup> 2048
- OF006N = c<sup>5</sup> 4096



OF010N = a<sup>1</sup> 440

Stimmgabeln für Neurologen  
Tuning forks for neurologists

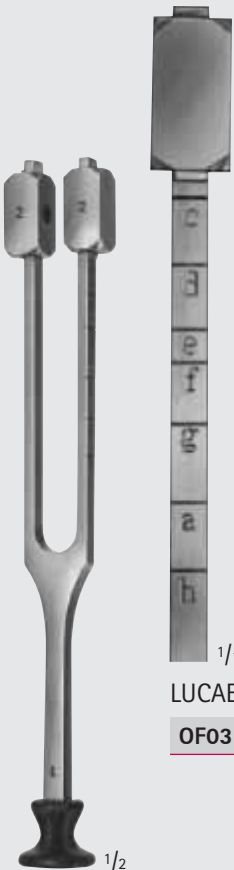

LUCAE

OF031N = c 128



RYDEL-SEIFFER

OF033N

mit Dämpfer = c 64  
ohne Dämpfer = c 128  
with clamps = c 64  
without clamps = c 128



## Untersuchung – Diagnostik – Examination – Diagnostic

### Instrumente zum Messen Instruments for Measuring



#### AA804R-AA806R

Stahlmaßstab, nichtrostend,  
Millimeter- und Zolleinteilung  
Steel ruler, stainless, graduated  
in millimeters and inches

AA804R	AA805R	AA806R
150 mm	300 mm	500 mm
6"	12"	20"

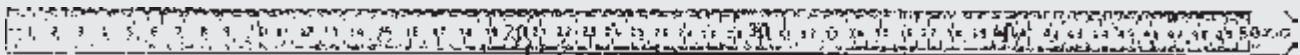

#### AA808R

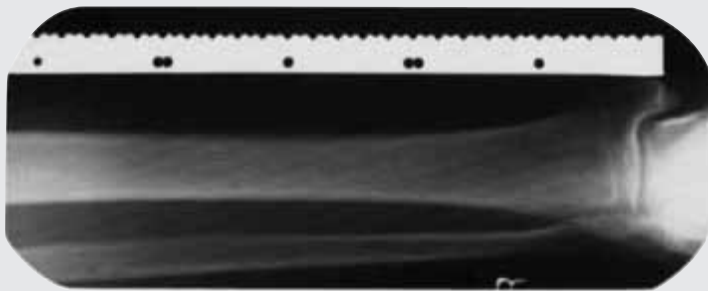

Röntgen-Messstab für Messungen bei Frakturbehandlung.  
Direkte Ablesemöglichkeit der Abmessungen.  
Einteilung in 1/2 cm durch gut sichtbare Kerben an  
der Kante, die vollen cm sind durch tiefe Kerben  
ersichtlich. Um das Ablesen zu erleichtern, sind  
die 5 cm und 10 cm Abstände durch Löcher markiert.  
Ruler for X-ray work in fracture treatment.  
Direct reading. Graduation from half to half cm by  
distinct notches at the rim. Full cms are accentuate  
by deeper notches. Markings of 5 cm and decimeter  
distance by one and two holes respectively.  
500 mm, 20"

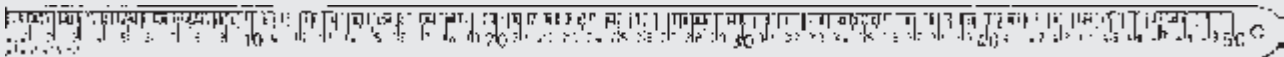

#### AA809

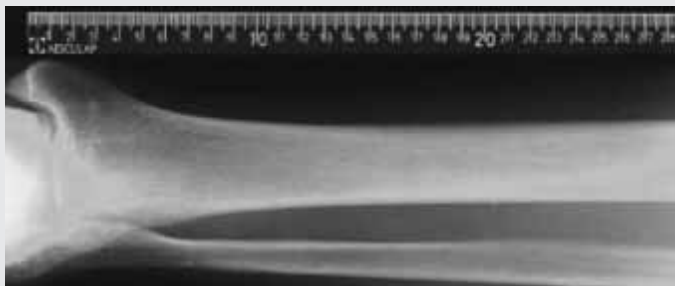

Röntgen-Messstab aus Kunststoff, flexibel  
im Autoklav sterilisierbar bei 143°C (3 bar).  
Dieser Röntgen-Messstab hat den Vorteil, dass die  
Zahlen und die Millimeteerteilung im Röntgenbild  
gut sichtbar sind.  
Plastic ruler, flexible, for X-ray work.  
Can be sterilized in an autoclave at 143°C (3 bar).  
Figures and mm-graduation transparent to X-ray.  
500 mm, 20"



#### AA821C-AA822C

Stahlmaßband, Millimeter- und Zolleinteilung  
Steel tape measure, graduated in millimeters and inches

#### AA826

Maßband aus Wachstuch, Millimeter- und Zolleinteilung  
Tape measure of oilcloth, graduated in millimeters and inches

**Hinweis:**  
Nicht zur Dampfsterilisation geeignet  
**Note:**  
Not suitable for steam sterilization

AA821C	AA822C	AA826
1,5 m	2,0 m	1,5 m
60"	80"	60"

AD

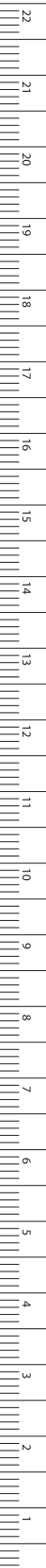

MILLIMETERS

## Untersuchung – Diagnostik – Examination – Diagnostic

Instrumente zum Messen

Instruments for Measuring

AD



**AA845R**

Spezial-Messschieber  
für die Neurochirurgie

Special caliper  
for neurosurgery

125 mm, 5"



**AA846R**

Messschieber,  
Messbereich bis 150 mm

Caliper,  
measuring range up to 150 mm  
230 mm, 9"



**AA847R**

Messschieber,  
Messbereich bis 100 mm

Caliper,  
measuring range up to 100 mm  
130 mm, 5 1/8"



**AD110R**

Finger-Goniometer  
Finger goniometer



**AD123R**

Ø 33 mm  
diam. 33 mm



**AD125R**

Ø 38 mm  
diam. 38 mm



**AD127R**

Ø 42 mm  
diam. 42 mm

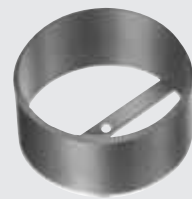

**AD129R**

Ø 48 mm  
diam. 48 mm

**AD123R-AD129R**

Mamillenmarkierer, gezahnt  
Mamilla marker, toothed



# Untersuchung – Diagnostik – Examination – Diagnostic

Vorbereitung  
Preparation

AN



**BA244R**

Rasierklingenmesser für auswechselbare Klingen, mit Sicherheitskamm  
Razor for interchangeable blades, with safety clip



**BA245R**

Ersatzklingen  
Bestelleinheit: **PAK** = Packung a 10 Stück  
Spare blades  
Sales unit: **PAK** = Package of 10 pieces  
70 mm, 2 3/4"



**GH201-GH204**

Die Wartung der AESCULAP Electra® II ist problemlos. Der dauerhaft gefettete Elektromotor mit ruhigem Lauf benötigt keine Pflege, nur die Schneideköpfe sind regelmäßig zu ölen. Die Maschine ist schutzisoliert.

Elektrische Schermaschinen (ohne Schneideköpfe)

Maintenance for the AESCULAP Electra® II is no problem at all. The permanently lubricated motor does not need any maintenance - only the cutterheads require periodic oiling. The clipper is double insulated.

Electric hair clippers (without cutterheads)

**GH201**

110-125 Volt  
110-125 volts

**GH204**

220 Volt  
220 volt

**Zulassungen:**

**Registrations:**

gemäß Richtlinie 89/336/EWG und 73/23/EW  
conforming to directive 89/336/EEC and 73/23/EEC



**GH700-GT784**

Auswechselbare Schneideköpfe  
Interchangeable cutterheads

Schnitthöhe  
Height of clip

<b>GH700</b>	1/20 mm		
<b>GH703</b>	1/10 mm		
<b>GT730</b>	1/2 mm		
<b>GH712</b>	1 mm		
<b>GT736</b>	1 mm	weite Zahnung	wide tooth
<b>GT746</b>	1,5 mm		
<b>GT710</b>	1,8 mm	feine Zahnung	fine tooth
<b>GH715</b>	2 mm	kurze Zähne	short teeth
<b>GT742</b>	2 mm	lange Zähne	long teeth
<b>GT754</b>	3 mm	kurze Zähne	short teeth
<b>GT748</b>	3 mm	lange Zähne	long teeth
<b>GT758</b>	5 mm		
<b>GT770</b>	7 mm		
<b>GT779</b>	9 mm		
<b>GT782</b>	12 mm		
<b>GT784</b>	16 mm		

**Hinweis:**

Die Schneideköpfe passen auch auf den seither gelieferten Maschinentyp Elektra I.

**Note:**

Cutterhead system - to be used interchangeably for Elektra II as well as for Elektra I clipper.



MILLIMETERS

# Untersuchung – Diagnostik – Examination – Diagnostic

Vorbereitung

Preparation

weitere Waschzangen siehe Rubrik BF  
further dressing forceps see section BF

AN

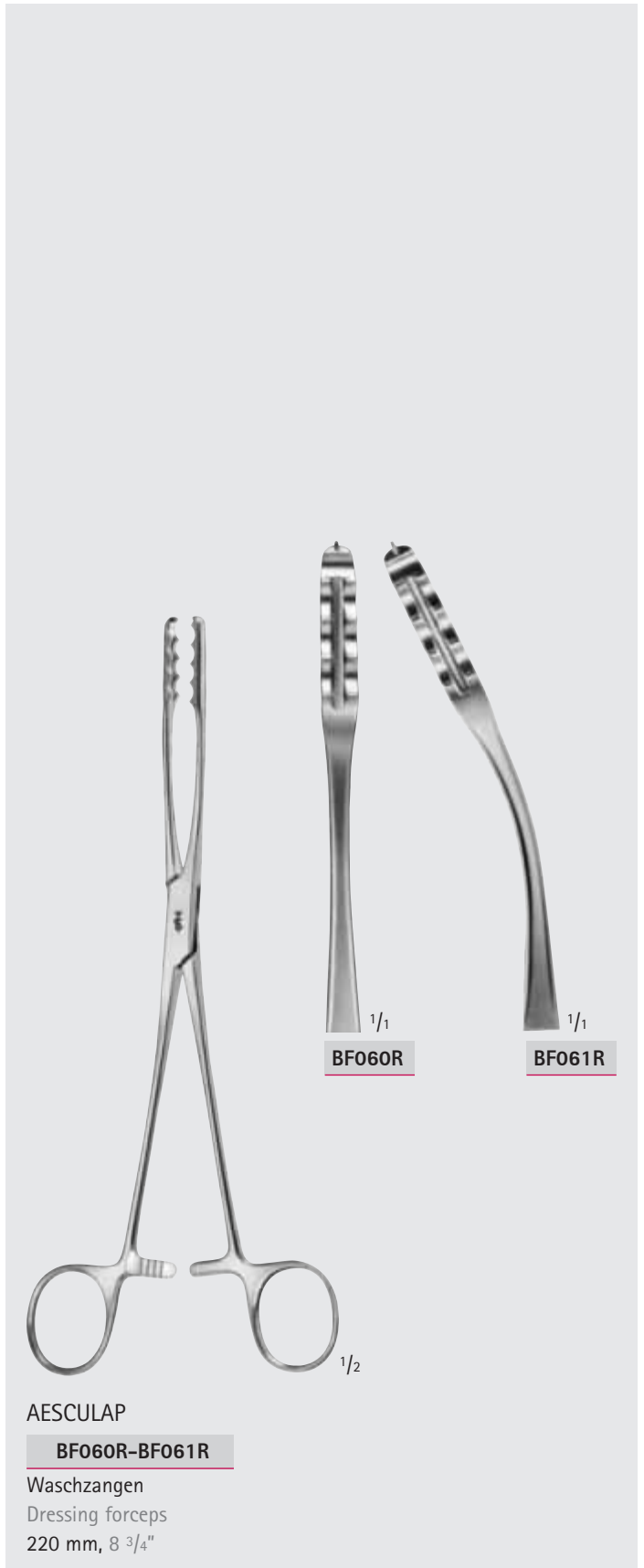



# Untersuchung – Diagnostik – Examination – Diagnostic

Vorbereitung  
Preparation

AN

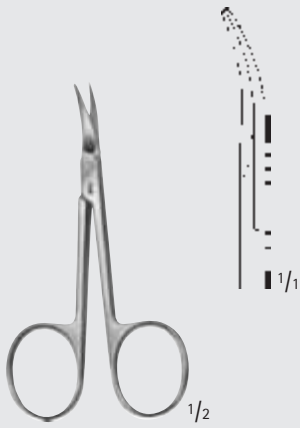

**HF400R**

Nagelschere  
Nail scissors  
90 mm, 3 1/2"

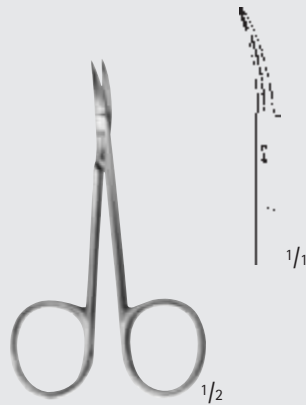

**HF409R**

Nagelschere  
extra feines Modell  
Nail scissors  
especially delicate pattern  
90 mm, 3 1/2"



**HF032R**

Baby-Nagelschere  
Baby nail scissors  
85 mm, 3 1/8"



**HF014R-HF021R**

Nagelscheren  
Nail scissors

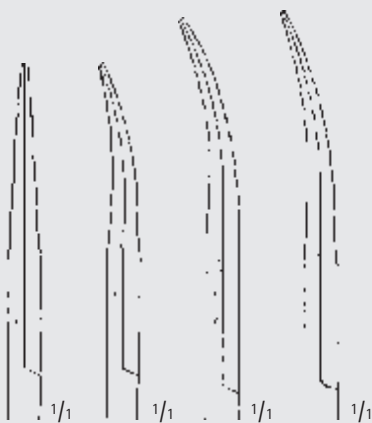

HF014R	HF019R	HF020R	HF021R
90 mm	90 mm	100 mm	110 mm
3 1/2"	3 1/2"	4"	4 3/8"



**HF028R-HF031R**

Nagelscheren  
Nail scissors



HF028R	HF030R	HF031R
95 mm	95 mm	105 mm
3 3/4"	3 3/4"	4 1/8"



MILLIMETERS

# Untersuchung – Diagnostik – Examination – Diagnostic

Vorbereitung

Preparation

AN



**BC056R**

**BC057R**

**BC056R-BC057R**  
90 mm, 3 3/4"

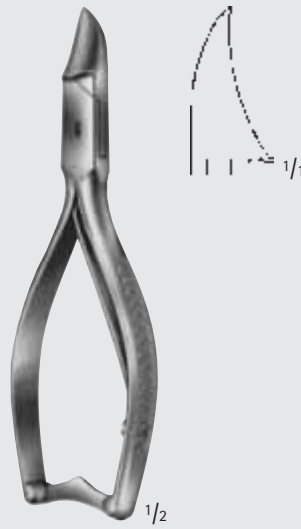

**HF213R**

Nagelzange  
Nail cutter  
135 mm, 5 1/4"

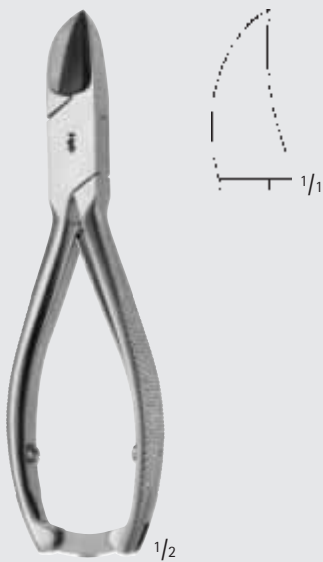

**HF234R**

Nagelzange  
Nail cutter  
145 mm, 5 3/4"



**HF250R**

Nagelzange  
Nail cutter  
155 mm, 6"





1/2

**HF520R**

Nagelschere HF020R und Nagelfeile HF514R  
 mit 50 cm langer verchromter Kette HF519C  
 Nail scissors HF020R and nail file HF514R  
 with 50 cm (19 1/2"), chromium plated-chain HF519C



1/1

1/1

**HF514R**

Nagelfeile  
 Nail file  
 100 mm, 4"



1/1

**HF566R**

Nagelfeile  
 Nail file  
 150 mm, 6"



MILLIMETERS

## Untersuchung – Diagnostik – Examination – Diagnostic

### Narkoseinstrumente

#### Instruments for Anaesthesia

Zungenspatel siehe Rubrik AC  
Tongue depressors see section AC



1/2

**OM010**

Mundsperrer aus Holz  
Mouth gag wooden  
140 mm, 5 1/2"



1/1

SCHMID

**OM015R**

Mundsperrer stufenlos durch Gewinde zu verstellen, 1 Maulteil beweglich gelagert  
Mouth gag, infinitely adjustable by thread, with 1 moveable part



1/2

HEISTER

**OM030R**

Mundsperrer  
Mouth gag  
130 mm, 5 1/8"



1/2

FERGUSON-ACKLAND

**OM044R**

Mundsperrer  
Mouth gag  
145 mm, 5 3/4"



**Untersuchung - Diagnostik - Examination - Diagnostic**  
 Narkoseinstrumente  
 Instruments for Anesthesia

**AN**

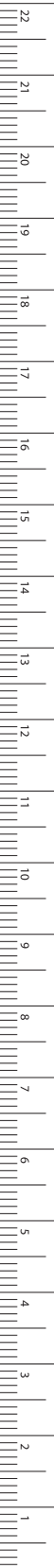

1/2

**OM047R**

Mundsperrer  
 Mouth gag  
 125 mm, 5"



1/2

**ROSER-KÖNIG**

**OM048R**

Mundsperrer  
 Mouth gag  
 160 mm, 6 1/4"



1/2

**ROSER-KÖNIG**

**OM049R**

Mundsperrer  
 Mouth gag  
 185 mm, 7 1/4"



1/2

**MAGILL**

**AN379R-AN381R**

Kathetereinführungszangen  
 Catheter introducing forceps



**AN379R**

für Kleinkinder  
 for infants  
 150 mm  
 6"



**AN380R**

für Kinder  
 for children  
 200 mm  
 8"



1/1

**AN381R**

für Erwachsene  
 for adults  
 250 mm  
 10"

MILLIMETERS

# Untersuchung - Diagnostik - Examination - Diagnostic

## Zungenzangen Tongue Forceps

AN

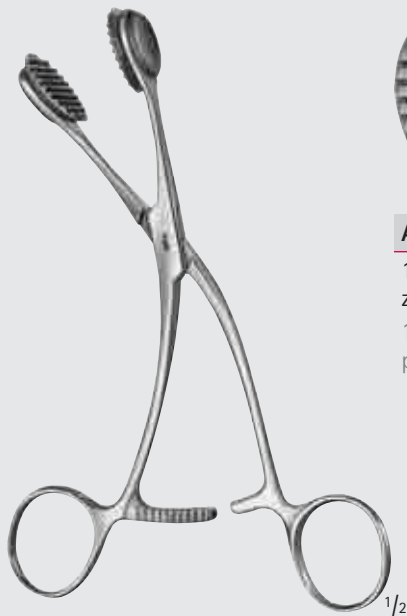

YOUNG

**AN705R**

165 mm, 6 1/2"



**AN706**

1 Paar Ersatzgummi  
zu AN705R  
1 pair of rubber  
pads for AN705R



COLLIN

**AN709R-BH906R**



**AN709R**

170 mm

6 3/4"



**BH906R**

160 mm

6 1/4"



HEYWOOD-SMITH

**AN710R**

200 mm, 8"



1/1



HEYWOOD-SMITH MODIF.

**AN711R**

215 mm, 8 1/2"



1/1



# Untersuchung – Diagnostik – Examination – Diagnostic

Vorbereitung

Preparation

AN



1/1

1/2

PEAN

**BH410R**

Schlauchklemme

Tubing clamp forceps

125 mm, 5"



1/1

1/2

KLINIKUM BERLIN

**AN908R**

Schlauchklemme

starkes Modell, lange Sperre,  
daher Durchlauf dosierbar

Tubing clamp

heavy pattern, long ratchet,  
therefore passage adjustable

145 mm, 5 3/4"



1/1

glattes Maul  
smooth jaw

1/2

**AN909R**

Schlauchklemme  
sehr starkes Modell

Tubing clamp forceps  
especially heavy pattern

165 mm, 6 1/2"



1/1

gerieftes Maul  
serrated jaw

1/2

**AN910R**

Schlauchklemme  
sehr starkes Modell

Tubing clamp forceps  
especially heavy pattern

165 mm, 6 1/2"

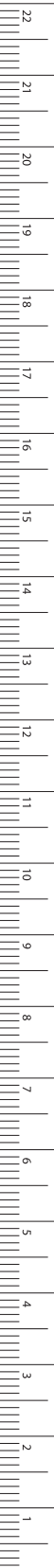

MILLIMETERS

# Untersuchung – Diagnostik – Examination – Diagnostic

Vorbereitung

Preparation

AN



**AN911R**

Schlauchklemme  
Tubing clamp  
180 mm, 7"



**AN912R**

Schlauchklemme  
Tubing clamp  
180 mm, 7"



**AN913R**

Schlauchklemme  
Tubing clamp  
200 mm, 8"



**MD452R-MD454R**

Schlauchklemmen  
Tubing clamps





SAUERBRUCH

**JG850R**

Fasszange für verbrauchtes  
Verbandmaterial und Tupfer

Operating Room

Pick-up forceps for used  
tampons and dressings

550 mm, 22"

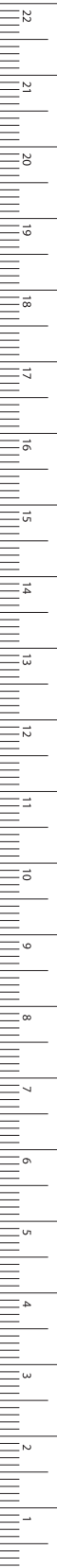

MILLIMETERS

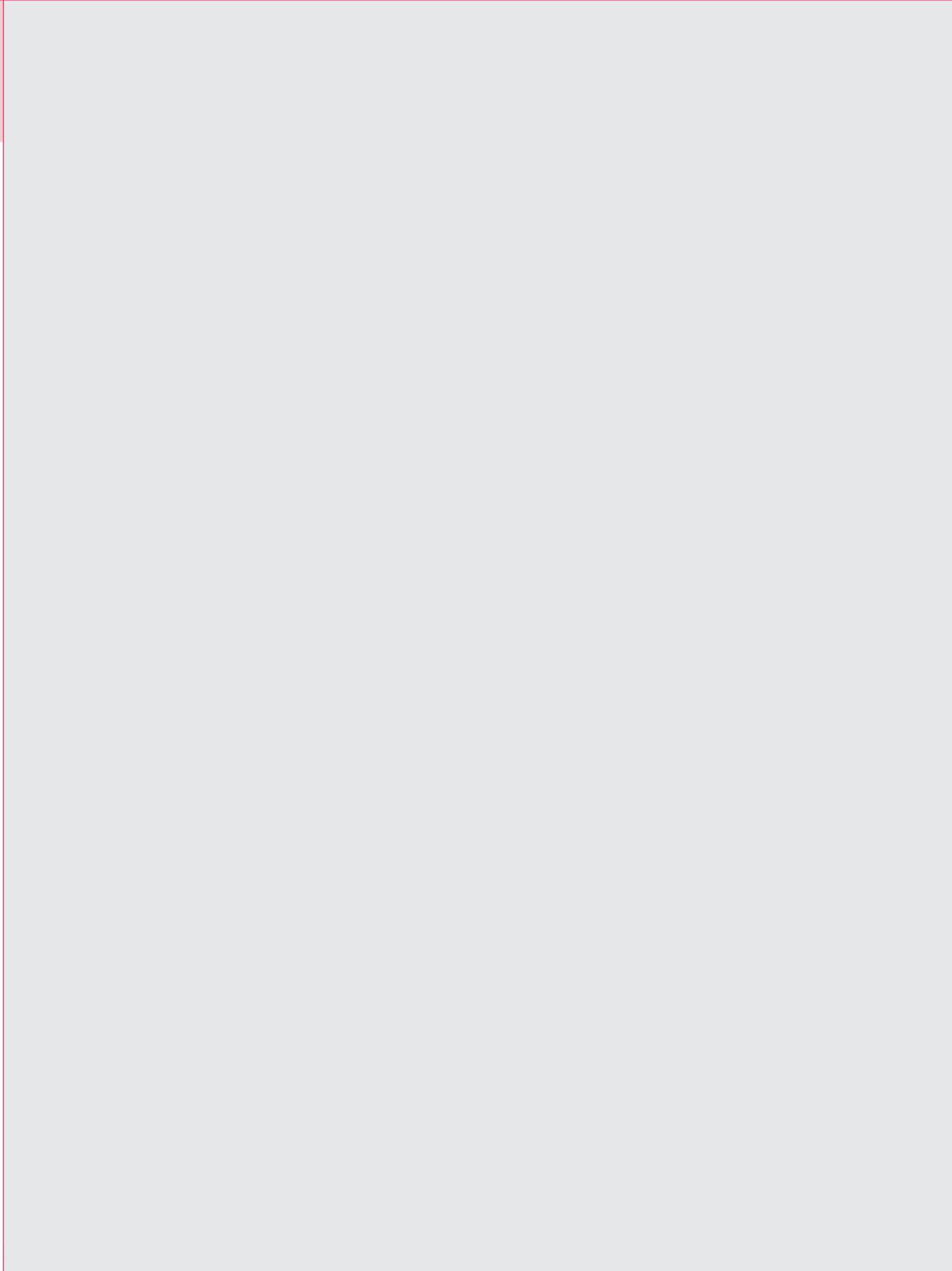



BA

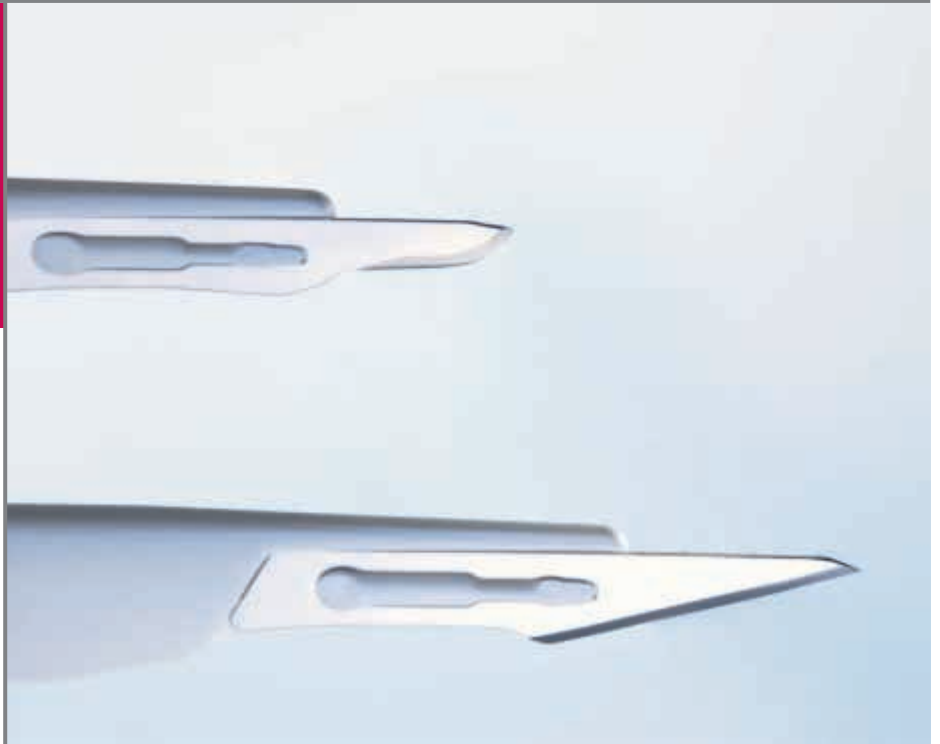

**Sterilskalpelle, Skalpelle, Messer**  
Sterile Scalpels, Scalpels, Knives

## Sterilskalpelle – Sterile Scalpels

Sterilskalpelle mit Kunststoffheft und Klingenschutz

Sterile Scalpels with Plastic Handle and Blade Protector

BA



1/1

Carbon Steel **BA210**  
Stainless Steel **5518059**  
Fig. 10



1/1

**BA211**  
**5518040**  
Fig. 11



1/1

**BA212**  
**5518105**  
Fig. 12



1/1

**BA215**  
**5518032**  
Fig. 15



1/1

**BA215-1**  
Fig. 15



1/1

**BA215-C**  
Fig. 15



1/1

**BA218**  
Fig. 18





## Sterilskalpelle – Sterile Scalpels

Sterilskalpelle mit Kunststoffheft und Klingenschutz  
Sterile Scalpels with Plastic Handle and Blade Protector



1/1

Carbon Steel  
Stainless Steel

**BA219**

Fig. 19



1/1

**BA220**

**5518067**

Fig. 20



1/1

**BA221**

**5518075**

Fig. 21



1/1

**BA222**

**5518083**

Fig. 22



1/1

**BA223**

**5518016**

Fig. 23



1/1

**BA224**

**5518091**

Fig. 24

BA



MILLIMETERS

**BA210-BA224/5518016-5518105**

Bestelleinheit:

PAK = Packung à 10 Stück

Sales unit:

PAK = Package of 10 pieces

## Sterilskalpelle – Sterile Scalpels

Einmalskalpelle, Mikroskalpelle mit Plastikgriff

Scalpels for Single Use, Microsurgery Scalpels with Plastic Handle

Bestelleinheit:

PAK = Packung à 10 Stück

Sales unit:

PAK = Package of 10 pieces

Bestelleinheit:

PAK = Packung à 5 Stück

Sales unit:

PAK = Package of 5 pieces



**BA311SU**

Fig. 11  
230 mm, 9"



**BA323SU**

Fig. 23  
230 mm, 9"



**BA364**

165 mm, 6 1/2"



**BA365**

165 mm, 6 1/2"



**BA367**

165 mm, 6 1/2"

BA





## Sterilskalpelle – Sterile Scalpels

Zeichenfeder  
Mapping Pens

BA



1/1

**ECKHOFF**

**BA704R**

Zeichenfeder, komplett  
Mapping pen, complete  
145 mm, 5 3/4"



1/1

Bestelleinheit:  
**PAK** = Packung à 12 Stück  
Sales unit:  
**PAK** = Package of 12 pieces

**BA705**

Zeichenfeder, allein  
zum Einmalgebrauch  
Nib, only  
for single use



**AD099R**

Metallgefäß für  
Markierungsflüssigkeit  
Metal ink pot

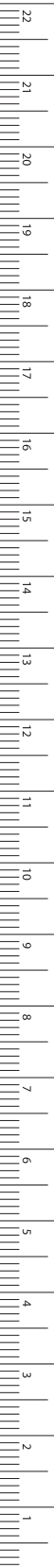

MILLIMETERS

## Sterilskalpelle – Sterile Scalpels

Skalpelle  
Scalpels

BA



BA401R

BA402R

BA403R

BA407R

BA408R

BA409R

BA401R-BA409R

130 mm, 5 1/8"



BERGMANN

BA451R

140 mm, 5 1/2"



## Sterilskalpelle – Sterile Scalpels

Skalpelle, Tenotome

Scalpels, Tenotomes

BA



BA501R

BA503R

BA504R

BA506R

BA507R

BA508R

BA509R

BA546R

BA514R

BA563R

Tenotom  
Tenotome

BA501R-BA563R

140 - 175 mm, 5 1/2 - 7"

MILLIMETERS

# Sterilskalpelle – Sterile Scalpels

Amputationsmesser

Amputation Knives

BA



doppelschneidig  
double cutting

LISTON

**FH100R-FH103R**

Amputationsmesser  
Amputation knives

	FH100R	FH101R	FH102R	FH103R
Schnittlänge:	130 mm	160 mm	190 mm	220 mm
Blade length:	5 1/8"	6 1/4"	7 1/2"	8 3/4"

Schnittlänge: 130 mm 160 mm 190 mm 220 mm  
Blade length: 5 1/8" 6 1/4" 7 1/2" 8 3/4"



doppelschneidig  
double cutting

CATLIN

**FH116R**

Amputationsmesser  
Amputation knife

Schnittlänge: 160 mm  
Blade length: 6 1/4"



LANGENBECK

**FH150R**

Lappenmesser  
Flap knife

Schnittlänge: 120 mm  
Blade length: 6 1/4"





**Sterilskalpelle – Sterile Scalpels**  
 Amputations- und Resektionsmesser  
 Amputation- and Resection Knives

**BA**



1/2

**FH160R**

Phalangenmesser  
Phalangeal knife

Schnittlänge: 105 mm  
Blade length: 4 1/8"



1/2

**FH166R**

Zwischenknochenmesser  
Interosseous knife

Schnittlänge: 110 mm  
Blade length: 4 3/8"

doppelschneidig  
double cutting



1/2

**FH170R**

Beinhautmesser  
mit Schaber  
Periosteum knife  
with raspatory

Schnittlänge: 65 mm  
Blade length: 2 1/2"



1/2

LANGENBECK

**FH191R-FH192R**

Resektionsmesser  
Resection knives

Schnittlänge: 55 mm  
Blade length: 2 1/8"



**FH191R**



**FH192R**

1/1



MILLIMETERS

## Sterilskalpelle – Sterile Scalpels

Fistelmesser

Fistula Knives

BA



1/1

SIMON

**BA604R-BA606R**

200 mm, 8"



**BA604R**



**BA605R**



1/1

**BA606R**



1/1

ULRICH

**BA611R**

225 mm, 9"



## Sterilskalpelle – Sterile Scalpels

Trigeminus- und Tonsillenmesser  
Trigeminal- and Tonsil Knives

BA



1/1

**OLIVECRONA**

**BA646R**

Trigeminusmesser  
Trigeminal knife  
205 mm, 8"



1/1

**BA641R**

Trigeminusmesser  
Trigeminal knife  
230 mm, 9"



1/1

**FOWLER**

**OM680R**

Tonsillenmesser  
Tonsil knife  
200 mm, 8"



1/1

**ABRAHAM**

**OM681R**

Tonsillenmesser  
Tonsil knife  
215 mm, 8 1/2"

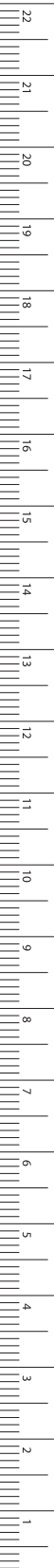

MILLIMETERS

## Sterilskalpelle – Sterile Scalpels

Skalpelle  
Scalpels

Meniskusmesser siehe Rubrik FO  
Meniskus knives see section FO

BA



MASING

**OL114R**

Knorpelritzmesser,  
in der Spitze gebogen  
Cartilage slitting knife,  
curved blade, pointed  
130 mm, 5 1/8"

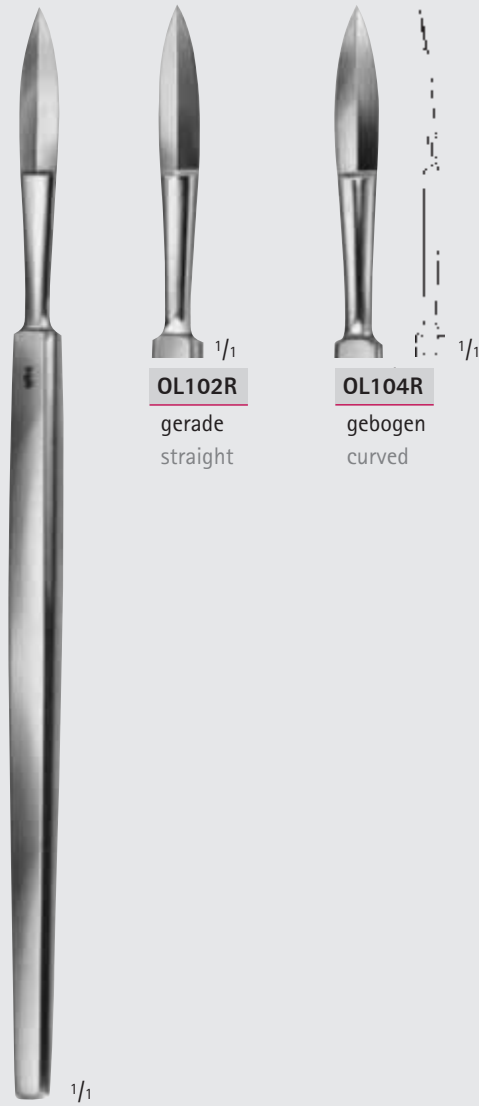

**OL102R**

gerade  
straight

**OL104R**

gebogen  
curved

JOSEPH

**OL102R-OL104R**

Plastikmesser

Double-edged nasal knives,  
pointed  
145 mm, 5 3/4"

## Sterilskalpelle – Sterile Scalpels

Sterilisierrahmen, Hautstanzen  
Sterilizing Racks, Dermal Punches

BA

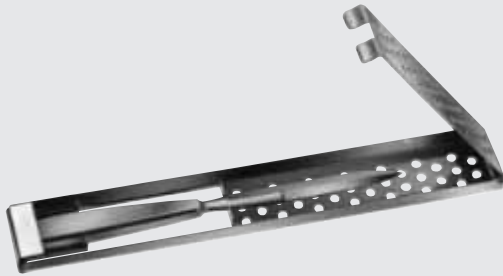

### FH194R

Sterilisierrahmen für 1 Messer  
mit Schnittlänge bis 140 mm  
Sterilizing rack for 1 knife  
with length of blade up to 140 mm  
290 x 40 x 14 mm

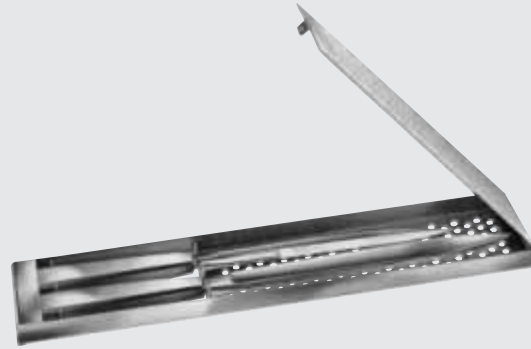

### FH197R

Sterilisierrahmen für 2 Messer  
mit Schnittlängen bis 190 mm  
Sterilizing rack for 2 knives  
with length of blade up to 190 mm  
335 x 65 x 14 mm

### FH194R-FH197R

für Resektions- und Amputationsmesser  
for Resection- and Amputation knives



○ 1/1

### OL652R

Ø 2 mm  
diam. 2 mm

○ 1/1

### OL653R

Ø 3 mm  
diam. 3 mm

○ 1/1

### OL654R

Ø 4 mm  
diam. 4 mm

○ 1/1

### OL656R

Ø 6 mm  
diam. 6 mm

○ 1/1

### OL657R

Ø 7 mm  
diam. 7 mm

### KEYES

### OL652R-OL657R

Hautstanzen  
Dermal punches  
100 mm, 4"



### KEYES MODIF.

### OL670R

Hautstanze, komplett,  
mit 5 auswechselbaren Aufsätzen, Griff und Gestell  
Dermal punch, complete  
with 5 interchangeable tips, handle and rack



MILLIMETERS

## Sterilskalpelle – Sterile Scalpels

Handdermatome

Skin Grafting Knives

BA



GOULIAN

**BA710R**

Dermatom mit 3 Schnittschablonen in den Stärken 0,20, 0,25 und 0,30 mm, kpl. mit 5 Klingen BA711R  
Dermatome with 3 grafting templates 0.20, 0.25 and 0.30 mm thick, complete with 5 blades BA711R  
180 mm, 7"

**BA711R**

Ersatzklingen, unsteril  
Bestelleinheit:  
PAK = Packung à 50 Stück  
Spare blades, non sterile  
Sales unit:  
PAK = Package of 50 pieces



SCHINK

**BA706R**

Dermatom, einstellbar von 0,1 bis 2,0 mm, komplett, mit 1 auswechselbaren Klinge und 2 Spannplatten  
Dermatome, adjustable from 0.1 to 2.0 mm, complete, with 1 interchangeable blade and 2 skin straightening plates  
300 mm, 12"

**BA708R**

Ersatzklinge allein  
Spare blade only

**BA709R**

Spannplatte allein  
Skin straightening plate only

## Sterilskalpelle – Sterile Scalpels

### Handdermatome

### Skin Grafting Knives



SILVER

**BA715R**

Dermatom,  
ohne Klängen  
Skin graft knife,  
without blade  
190 mm, 7 1/2"

**BA716R**

Ersatzklinge, unsteril  
Bestelleinheit:  
PAK = Packung à  
5 Stück  
Spare blade, non sterile  
Sales unit:  
PAK = Package of  
5 pieces



Stange starr / bar fixed

WATSON

**BA719R**

Dermatom,  
ohne Klängen  
Skin graft knife,  
without blade  
300 mm, 12"

**BA718R**

Ersatzklinge, steril  
Bestelleinheit:  
PAK = Packung à  
10 Stück  
Spare blade, sterile  
Sales unit:  
PAK = Package of  
10 pieces



Stange nur oszillierend / bar only oscillating

COBBETT

**BA717R**

Dermatom,  
ohne Klängen  
Skin graft knife,  
without blade  
315 mm, 12"

**BA718R**

Ersatzklinge, steril  
Bestelleinheit:  
PAK = Packung à  
10 Stück  
Spare blade, sterile  
Sales unit:  
PAK = Package of  
10 pieces



Stange oszillierend und drehend / bar oscillating and rotating

BRAITHWAITE

**BA712R**

Dermatom,  
ohne Klängen  
Skin graft knife,  
without blade  
315 mm, 12"

**BA718R**

Ersatzklinge, steril  
Bestelleinheit:  
PAK = Packung à  
10 Stück  
Spare blade, sterile  
Sales unit:  
PAK = Package of  
10 pieces



HUMBY

**BA713R**

Dermatom,  
ohne Klängen  
Skin graft knife,  
without blades  
365 mm, 13 3/4"

**BA714R**

Ersatzklinge, steril  
Bestelleinheit:  
PAK = Packung à  
10 Stück  
Spare blade, sterile  
Sales unit:  
PAK = Package of  
10 pieces

BA

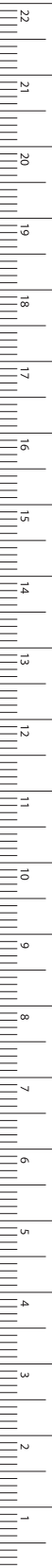

MILLIMETERS

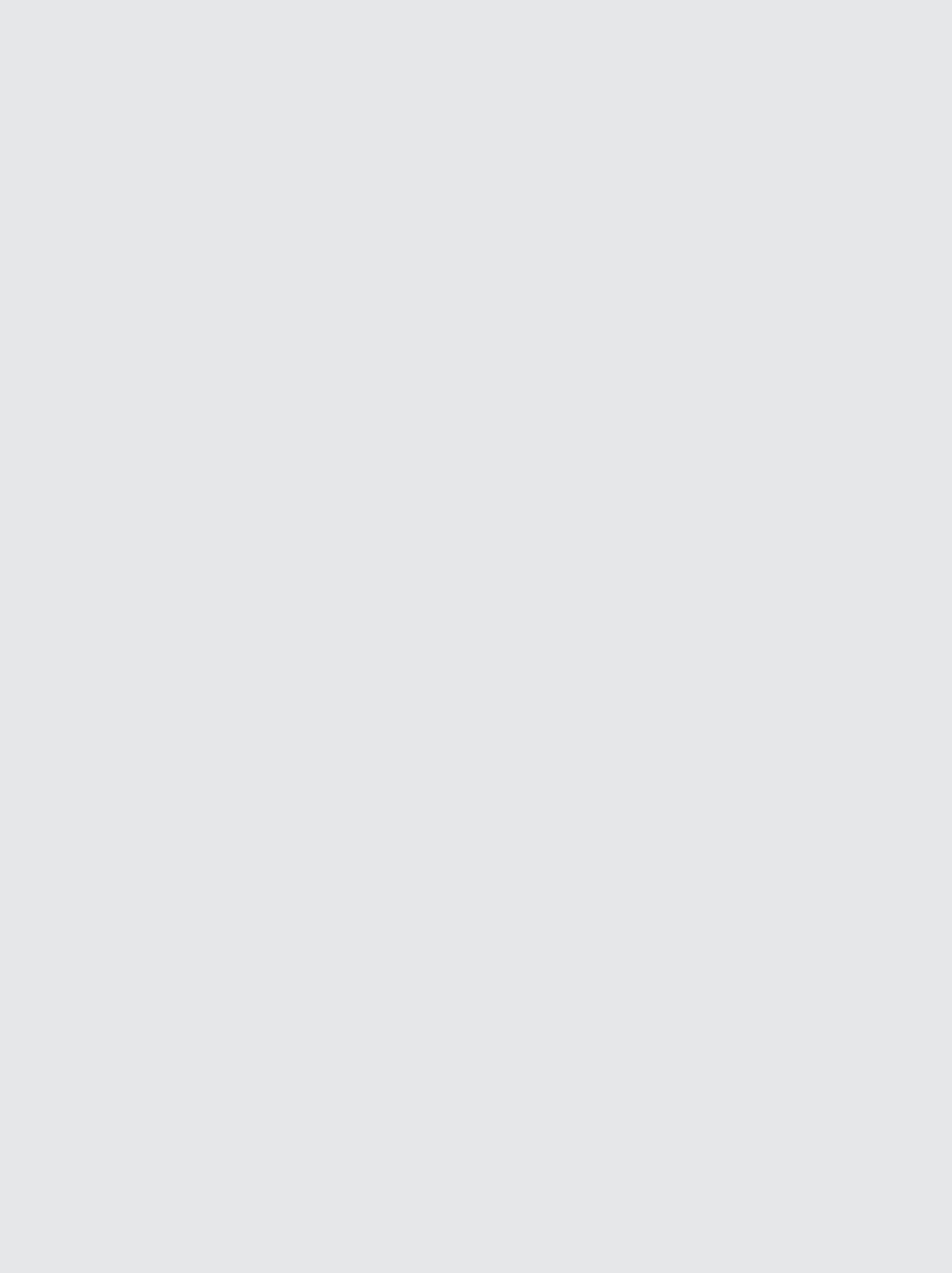



BB

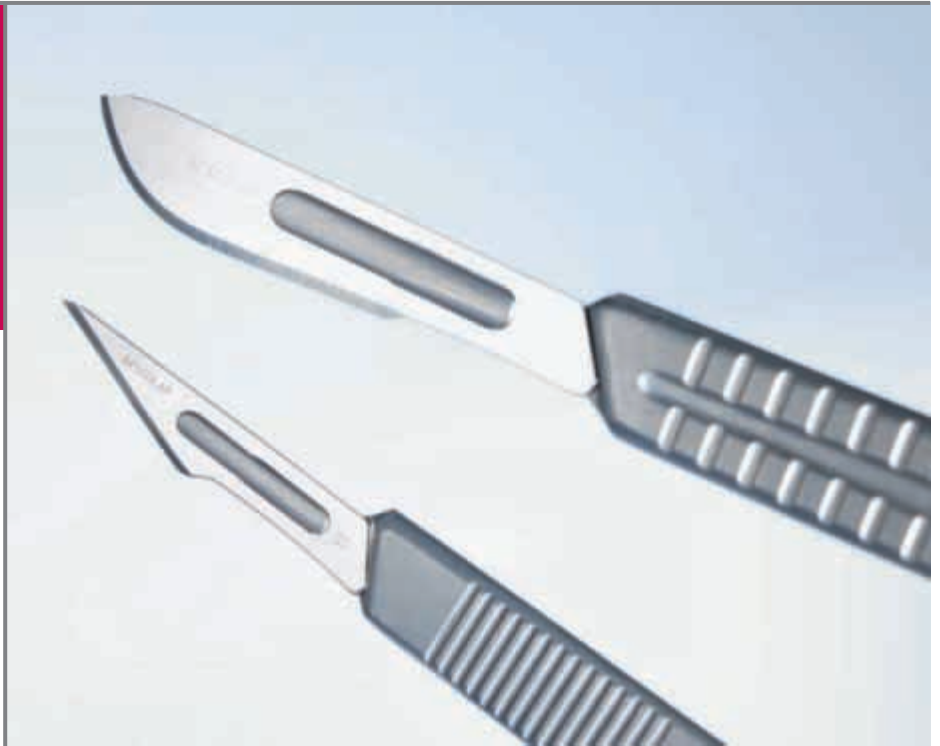

Skalpellklingen und Griffe  
Scalpel Blades and Handles

# Skalpellsklingen und Griffe – Scalpel Blades and Handles

Skalpellsgriffe  
Scalpel Handles

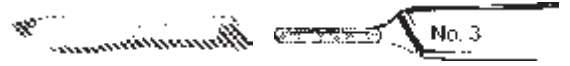

Für Klingen Fig. 10 - 15 und Fig. 40, 42  
For blades fig.10 - 15 and fig. 40, 42

BB

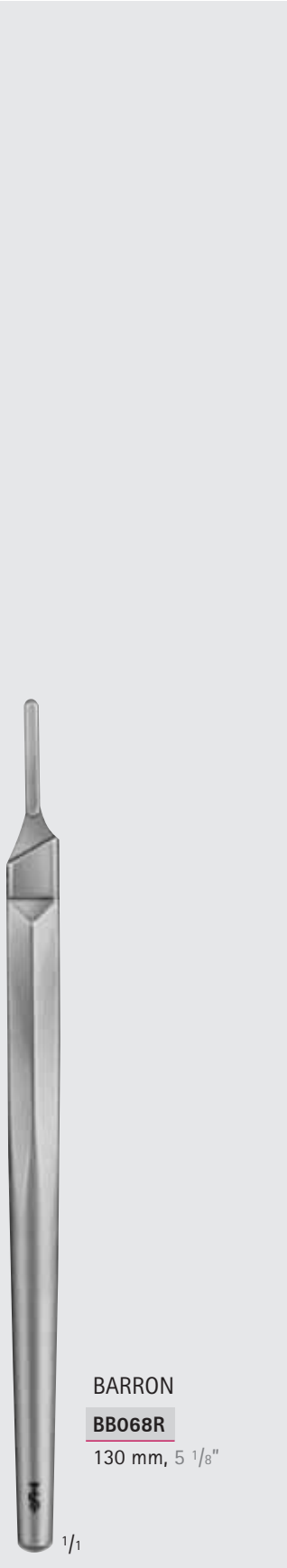

**BARRON**  
**BB068R**  
130 mm, 5 1/8"

1/1

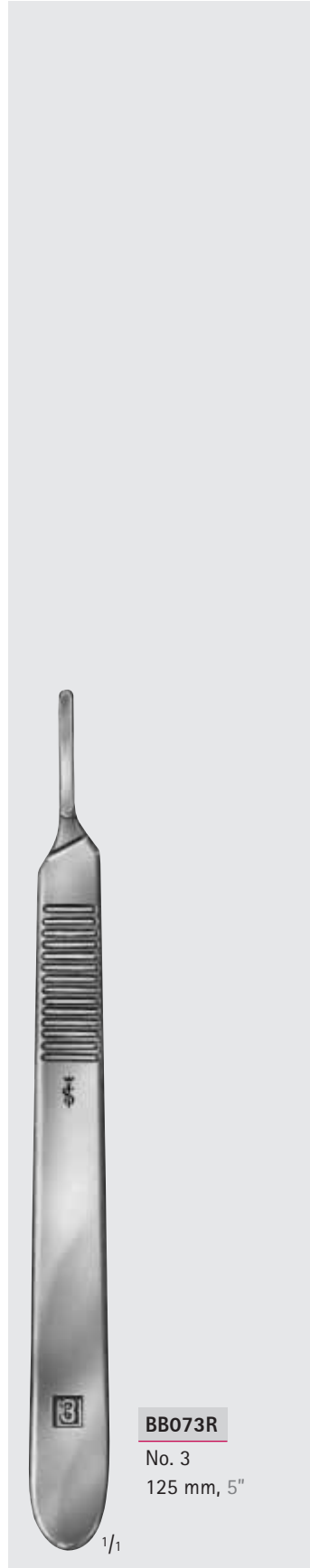

**BB073R**  
No. 3  
125 mm, 5"

1/1



**BB074R**  
No. 3  
125 mm, 5"

1/1

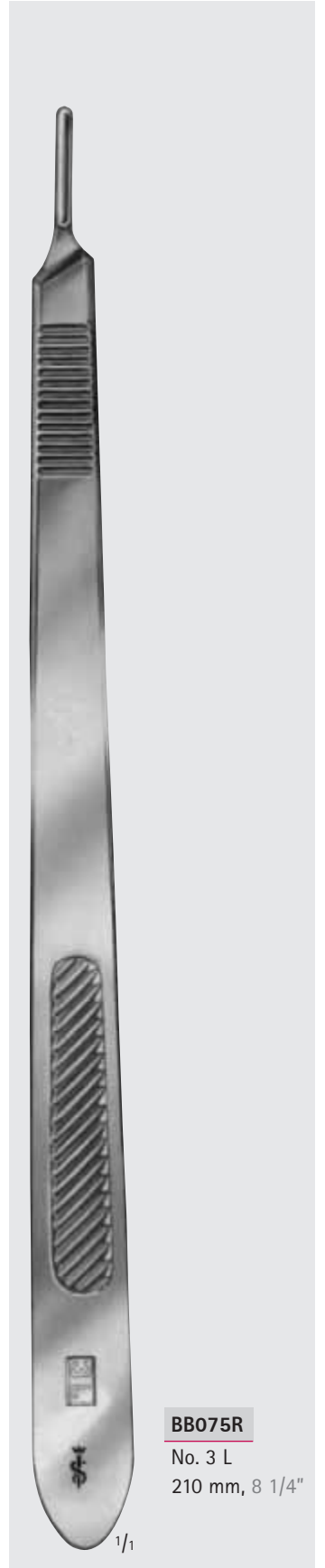

**BB075R**  
No. 3 L  
210 mm, 8 1/4"

1/1



# Skalpellsklingen und Griffe – Scalpel Blades and Handles

Skalpellsgriffe  
Scalpel Handles



Für Klingen Fig. 10 - 15 und Fig. 40, 42  
For blades fig.10 - 15 and fig. 40, 42

BB



**BB175R**  
No. 3 XL  
250 mm, 10"



BARRÉ

**BB176R-BB178R**

No. 3 XL  
für linke Hand  
for left hand  
250 mm, 10"



**BB177R**



**BB176R**  
12°



**BB178R**  
25°



entspricht der  
englischen  
No. 5  
corresponds  
with english  
No. 5

**BB077R**  
No. 7  
160 mm, 6 1/4"

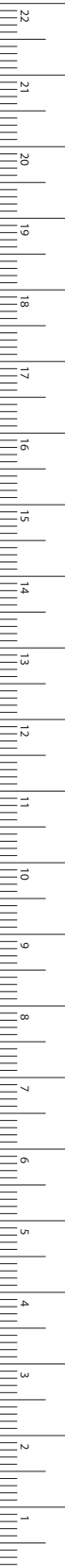

# Skalpellklingen und Griffe – Scalpel Blades and Handles

Skalpellgriffe

Scalpel Handles

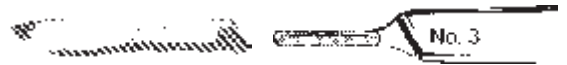

Für Klingen Fig. 10 - 15 und Fig. 40, 42

For blades fig. 10 - 15 and fig. 40, 42

BB



**BB078R**

225 mm, 9"



**BB079R**

225 mm, 9"



**BB071R**

210 mm, 8 1/4"



**BB070R**

155 mm, 6"



**BB063R**

145 mm, 5 3/4"



# Skalpellklingen und Griffe – Scalpel Blades and Handles

Skalpellgriffe  
Scalpel Handles



Für Klingen Fig. 18 - 36  
For blades fig. 18 - 36

BB



**BB084R**  
No. 4  
135 mm, 5 1/4"



**BB085R**  
No. 4 L  
215 mm, 8 1/2"



**BB087R**  
No. 4 XL  
250 mm, 10"



**BB080R**  
No. 4  
225 mm, 9"



**BB088R**  
No. 8  
130 mm, 5 1/8"



**BB089R**  
145 mm, 5 3/4"



MILLIMETERS

# Skalpellsklingen und Griffe – Scalpel Blades and Handles

## Sterilklingen Sterile Scalpel Blades



vakuum vergütet  
heat-treated in vacuum

steril  
sterile



**BB**



1/1

Carbon Steel  
Stainless Steel

**BB510**  
**16600495**



1/1

**BB511**  
**16600509**



1/1

**BB512**  
**16600517**



1/1

**BB513**  
**16615492**



1/1

**BB515**  
**16600525**



1/1

Carbon Steel

**BB515-1**



1/1

**BB515-C**



1/1

**BB540**  
doppelschneidig  
double cutting



1/1

**BB542**  
doppelschneidig  
double cutting

passend zu den Griffen auf Seite 38 - 40  
Bestelleinheit:  
**PAK** = Packung à 100 Stück  
in Spenderpackung  
fitting handles on page 38 - 40  
Sales unit:  
**PAK** = Package of 100 pieces  
in dispenser package

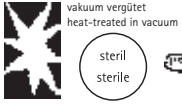

# Skalpellsklingen und Griffe – Scalpel Blades and Handles

Sterilklingen, Fadenmesser  
Sterile Scalpel Blades, Stitch-Cutter

**BB**

								
Carbon Steel	Carbon Steel	Carbon Steel	Carbon Steel	Carbon Steel	Carbon Steel	Carbon Steel	Carbon Steel	Carbon Steel
<b>BB518</b>	<b>BB519</b>	<b>BB520</b>	<b>BB521</b>	<b>BB522</b>	<b>BB523</b>	<b>BB524</b>	<b>BB525</b>	<b>BB536</b>
<b>16600541</b>	<b>16615514</b>	<b>16600550</b>	<b>16600568</b>	<b>16600576</b>	<b>16600584</b>	<b>16600592</b>	<b>16616634</b>	<b>16615522</b>
Stainless Steel	Stainless Steel	Stainless Steel	Stainless Steel	Stainless Steel	Stainless Steel	Stainless Steel	Stainless Steel	Stainless Steel

passend zu den Griffen auf Seite 41

Bestelleinheit:

**PAK** = Packung à 100 Stück  
in Spenderpackung

fitting handles on page 41

Sales unit:

**PAK** = Package of 100 pieces  
in dispenser package



Carbon Steel	<b>BB500</b>
Stainless Steel	<b>16600487</b>

Fadenmesser  
Stitch-cutter

Bestelleinheit:

**PAK** = Packung à 100 Stück

Sales unit:

**PAK** = Package of 100 pieces



## Skalpellsklingen und Griffe – Scalpel Blades and Handles

Skalpellsgriffe, rund, für mikrochirurgische Klingen

Scalpel Handles, Round, for Microsurgery Blades

BB



1/1

**BB046R**

135 mm, 5 1/2"



1/1

**BB048R**

155 mm, 6"



1/1

CASPAR

**BB052R**

180 mm, 7"



1/1

**BB054R**

200 mm, 8"



2/3

**BB060R**

330 mm, 12"





stainless steel  
steril sterile

## Skalpellschneidklingen und Griffe – Scalpel Blades and Handles

Skalpellschneidgriffe für mikrochirurgische Klingen – Mikrochirurgische Klingen  
Scalpel Handles for Microsurgery Blades – Microsurgery Blades

BB

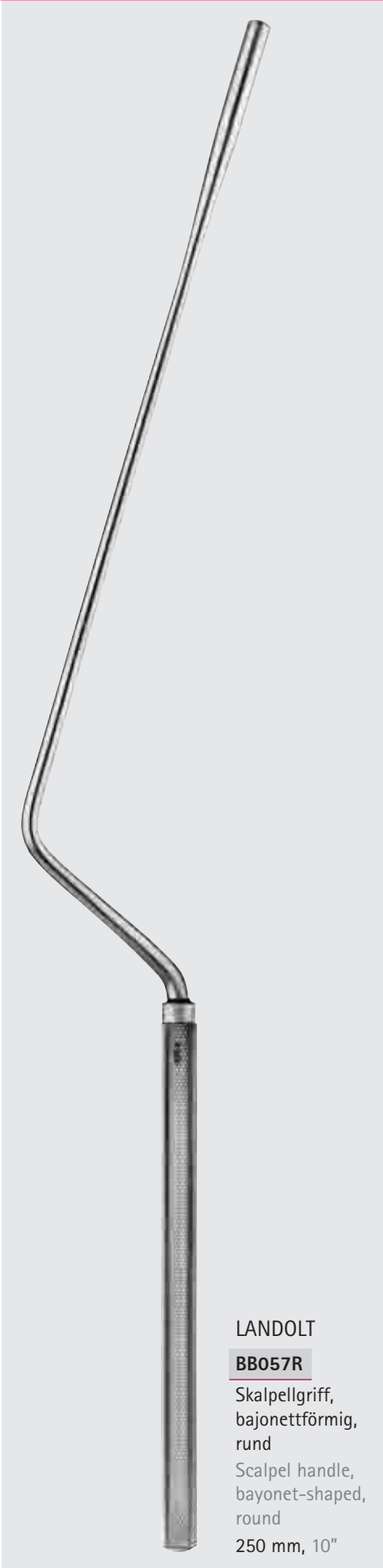

**LANDOLT**  
**BB057R**  
Skalpellschneidgriff, bajonettförmig, rund  
Scalpel handle, bayonet-shaped, round  
250 mm, 10"

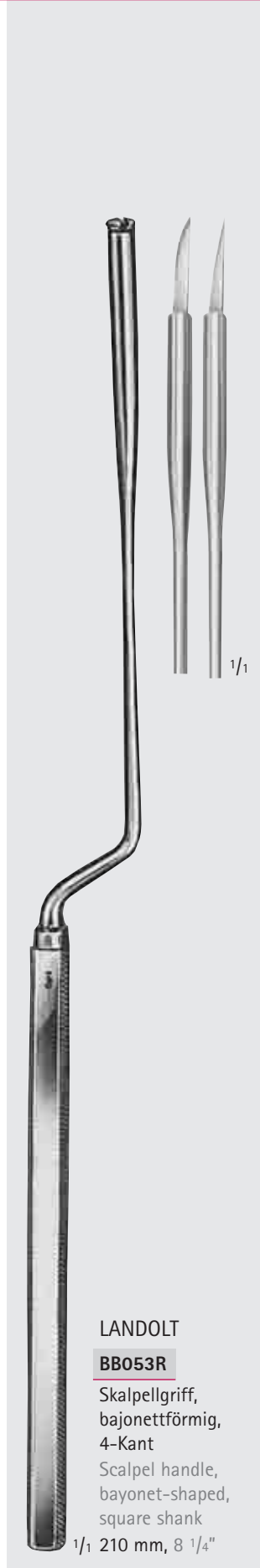

**LANDOLT**  
**BB053R**  
Skalpellschneidgriff, bajonettförmig, 4-Kant  
Scalpel handle, bayonet-shaped, square shank  
1/1 210 mm, 8 1/4"

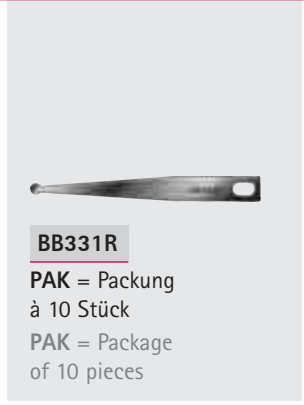

**BB331R**  
PAK = Packung à 10 Stück  
PAK = Package of 10 pieces

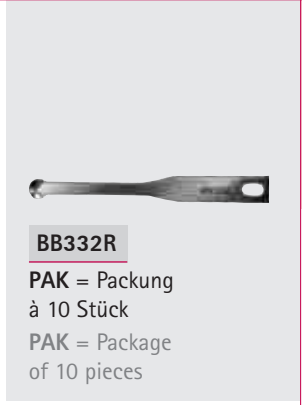

**BB332R**  
PAK = Packung à 10 Stück  
PAK = Package of 10 pieces

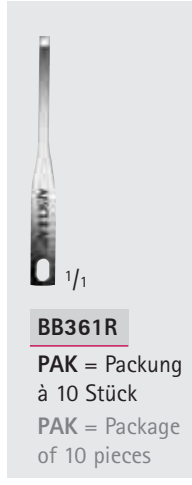

**BB361R**  
PAK = Packung à 10 Stück  
PAK = Package of 10 pieces

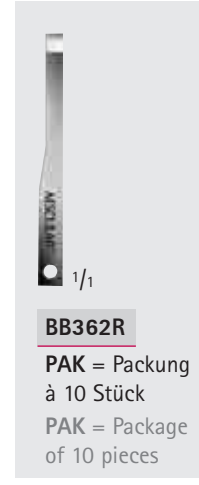

**BB362R**  
PAK = Packung à 10 Stück  
PAK = Package of 10 pieces



**BB363R**  
ST = Packung à 1 Stück  
ST = Package of 1 piece



**BB364R**  
PAK = Packung à 10 Stück  
PAK = Package of 10 pieces



**BB365R**  
PAK = Packung à 10 Stück  
PAK = Package of 10 pieces



**BB366R**  
ST = Packung à 1 Stück  
ST = Package of 1 piece



**BB367R**  
PAK = Packung à 10 Stück  
PAK = Package of 10 pieces



**BB368R**  
PAK = Packung à 10 Stück  
PAK = Package of 10 pieces



**BB369R**  
ST = Packung à 1 Stück  
ST = Package of 1 piece



MILLIMETERS

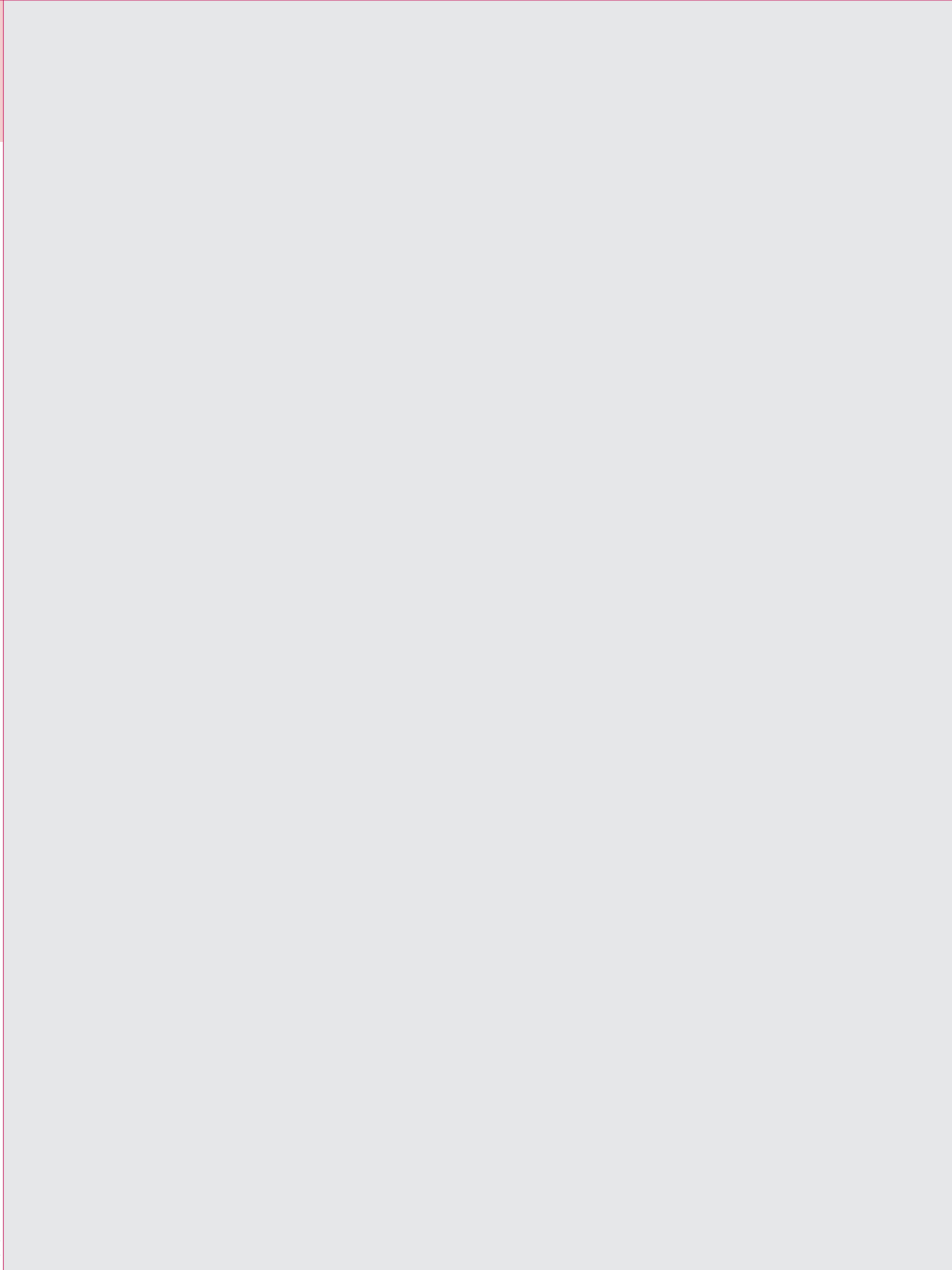



BC



Scheren  
Scissors

## Scheren – Scissors

Mikro-Federscheren mit Flachgriff

Micro Scissors (Spring Type) with Flat Handles

BC

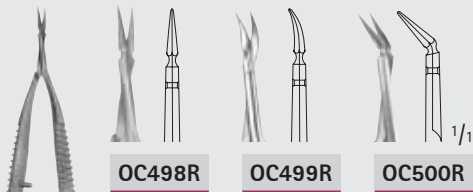

VANNAS

OC498R-OC500R

85 mm, 3 3/8"

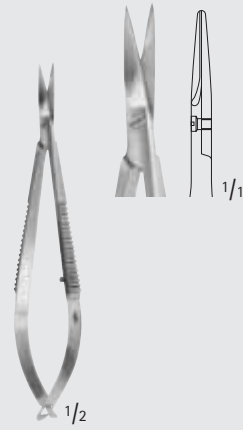

OC480R

95 mm, 3 3/4"

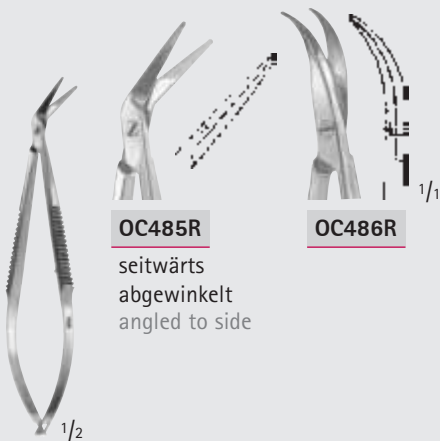

CASTROVIEJO

OC485R-OC486R

95 mm, 3 3/4"

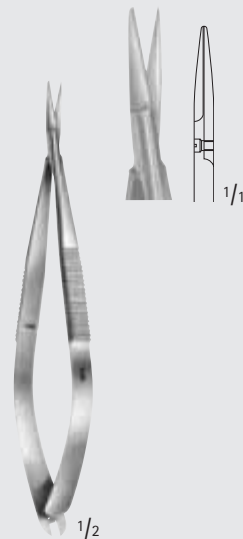

OC482R

125 mm, 5"





## Scheren – Scissors

Mikro-Federscheren mit Flachgriffen  
Micro Scissors (Spring Type) with Flat Handles

BC

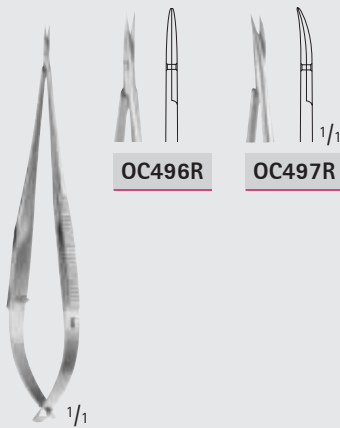

OC496R

OC497R

OC496R-OC497R

105 mm, 4 1/8"

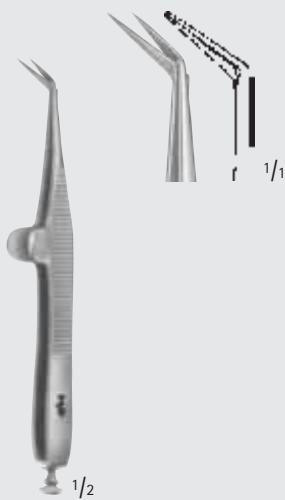

WECKER

OC461R

Augenschere

Eye scissors

110 mm, 4 1/2"

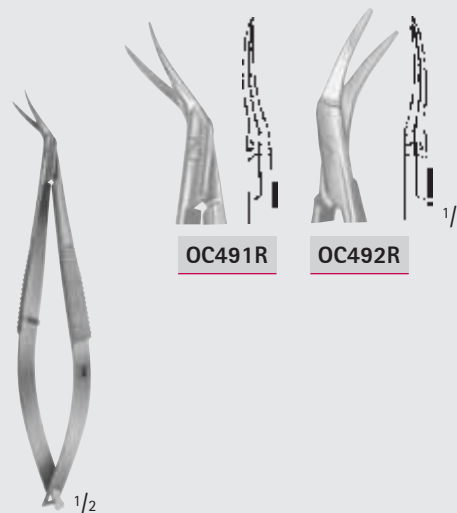

OC491R

OC492R

CASTROVIEJO

OC491R-OC492R

Augenschere

Eye scissors

110 mm, 4 3/8"



## Scheren – Scissors

Mikro-Federscheren mit Flachgriffen und Karoprofil

Micro Scissors (Spring Type) with Flat Handles and Cross-Serration



... mit Flachgriffen und Karoprofil

- breite Flachgriffe mit griffigem Karoprofil
- sichere Handhabung

... with flat handle and cross-serration

- flat handles, sure grip due to cross-serration

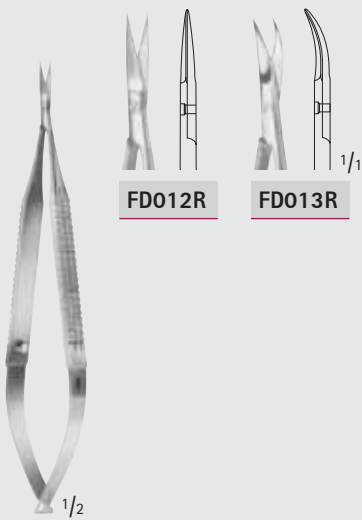

FD012R

FD013R

FD012R-FD013R

120 mm, 4 3/4"

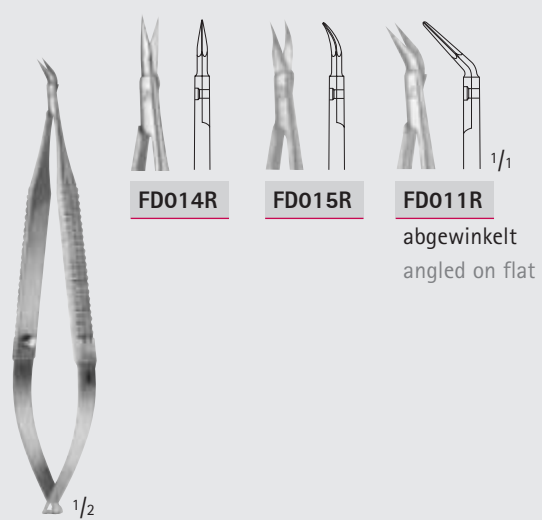

FD014R

FD015R

FD011R

abgewinkelt  
angled on flat

VANNAS

FD011R-FD015R

120 mm, 4 3/4"



## Scheren – Scissors

Mikro-Federscheren mit Flachgriffen und Karoprofil  
Micro Scissors (Spring Type) with Flat Handles and Cross-Serration



**Venenschere FD028R**  
zum Auffrischen von Gefäßstümpfen

- kein Abgleiten des Gefäßes
- glatte, saubere Durchtrennung

**Vein scissors FD028R**  
for roughening vessel ends

- vessel cannot slip off
- clean, smooth cut



BIEMER

**FD028R**

Venenschere  
Vein scissors  
130 mm, 5 1/8"

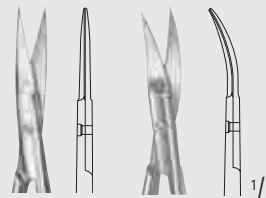

**FD016R**

**FD017R**



**FD016R-FD017R**

160 mm, 6 1/4"

BC

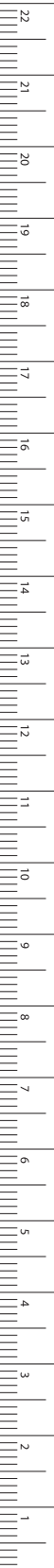

MILLIMETERS

## Scheren – Scissors

Mikro-Federscheren mit Flachgriffen und Karoprofil

Micro Scissors (Spring Type) with Flat Handles and Cross-Serration

BC

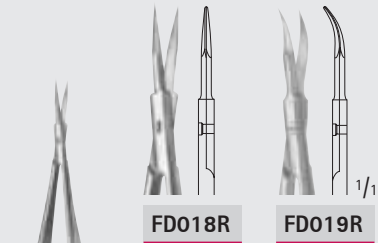

FD018R

FD019R

VANNAS

FD018R-FD019R

160 mm, 6 1/4"

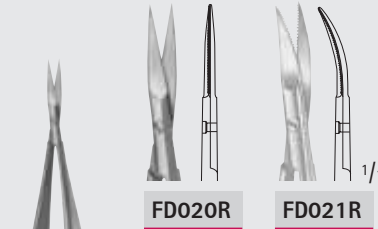

FD020R

FD021R

MILLESi

FD020R-FD021R

Schneiden gezahnt

Blades serrated

160 mm, 6 1/4"

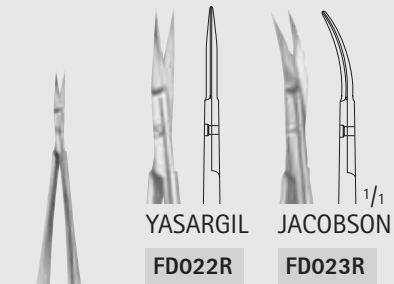

YASARGIL

JACOBSON

FD022R

FD023R

FD022R-FD023R

185 mm, 7 1/4"



## Scheren – Scissors

Mikro-Federscheren mit Rundgriffen  
Micro Scissors (Spring Type) with Round Handles

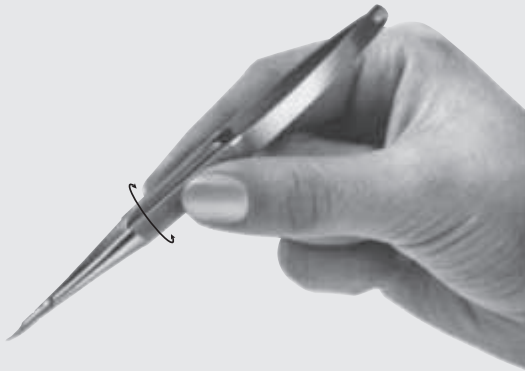

### ... mit Rundgriffen

- Rundgriffe erlauben Drehbewegungen zwischen den Fingern.
- Optimale Balance, individuell je nach Instrument, durch volle oder gehöhlte Griffpartien.

### ... with round handles

- Round handles allow turning manipulations between the fingers.
- Optimum balance individually for each instrument due to solid or hollowed-out handles.

BC

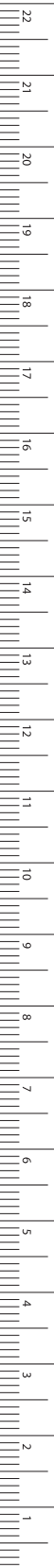

FD100R

FD101R

FD103R

Mikro-Präparierschere  
Micro dissecting scissors

FD100R-FD103R

145 mm, 5 3/4"

MILLIMETERS

## Scheren – Scissors

Mikro-Federscheren mit leichtem Kunststoffprofil  
Micro Scissors (Spring Type) with Light Plastic Handle

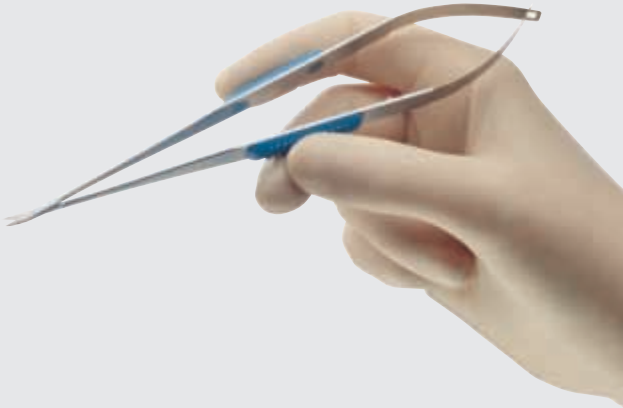

### Das MÜLLER Mikro-Instrumentarium

Ein hochwertiges Set für die periphere Mikrochirurgie. Zahlreiche praxisbewährte Details führen zu mehr Effektivität und Sicherheit.

#### ■ Unverkrampte Haltung = mehr Feingefühl

Das leichte Kunststoffprofil vergrößert die Griffoberfläche, gewährleistet dadurch eine unverkrampte Handhaltung und verleiht mehr Feingefühl.

#### ■ Leichteres Drehen = erweiterter Arbeitsbereich

Der runde Griffquerschnitt ermöglicht leichtes, gleichmäßiges Drehen des Instrumentes. Verwendungs- bzw. Arbeitsbereich wird dadurch erweitert.

#### ■ Sicherer Halt

Das griffige Noppenprofil gewährleistet einen durchweg sicheren Halt bei sämtlichen Bewegungsabläufen.

#### ■ Optimales Handling

Eine Entwicklung nach ergonomischen Gesichtspunkten, verbunden mit dem geringen Gewicht der neuen Kunststoffgriffe schaffen die Voraussetzung zu ermüdungsfreiem Arbeiten und optimalem Handling.

### The MÜLLER Micro instrument system

A top quality set for peripheral microsurgery. Numerous details tried and tested in practice mean increased efficiency and safety.

#### ■ Natural holding position = increased sensitivity

The light plastic profile increases the grip surface, thus guaranteeing a natural hand position without cramping and providing enhanced sensitivity.

#### ■ Easier rotation = extended working area

The round grip cross section permits easy and uniform rotation of the instrument. This extends the application and working areas.

#### ■ Safe grip

The easy grip studded profile guarantees a secure hold for all movements.

#### ■ Optimum handling

Development in accordance with ergonomic criteria and the low weight of the new plastic grips provide fatiguefree working and optimum handling.



## Scheren – Scissors

Mikro-Federschere mit leichtem Kunststoffprofil  
Micro Scissors (Spring Type) with Light Plastic Handle

BC



MÜLLER

**FM010R-FM014R**

120 mm, 4 3/4"



**FM010R**

spitz/spitz  
sharp/sharp



**FM011R**

spitz/spitz  
sharp/sharp



**FM012R**

spitz/stumpf  
sharp/blunt



**FM013R**

stumpf/stumpf  
blunt/blunt



**FM014R**

Kugel/spitz  
probe pointed/sharp



MÜLLER

**FM040R-FM041R**

170 mm, 6 3/4"



**FM040R**

spitz/spitz  
sharp/sharp



**FM041R**

spitz/spitz  
sharp/sharp



## Scheren – Scissors

Mikro-Federscheren mit Flachgriff

Micro Scissors with Flat Handle

BC



165 mm, 6 1/2"

1/1



## Scheren – Scissors

### Mikro-Federschere mit Flachgriff

### Micro Scissors with Flat Handle

25°

**FM470R**

45°

**FM471R**

60°

**FM472R**

90°

**FM473R**

125°

**FM474R**gerade  
straightaufgebogen  
curved  
on flatFeines Blatt  
Fine blade**FM451R****FM452R****FM453R****FM454R****FM455R**Feines Blatt,  
1 Blatt mit Knopf  
Fine blade,  
with 1 probe  
pointed blade**FM437R****FM438R****FM439R****FM440R****FM441R****FM442R****FM436R**Sehr feines Blatt  
Delicate blade**FM431R****FM432R****FM433R****FM434R****FM435R****FM444R****FM430R**Extrem feines Blatt  
Ultra delicate blade

BC

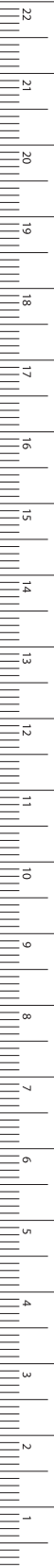

MILLIMETERS

## Scheren – Scissors

Mikro-Federscheren mit Rundgriff

Micro Scissors (Spring Type) with Round Handle

BC



165 mm, 6 1/2"

1/1



## Scheren – Scissors

Mikro-Federscheren mit Rundgriff  
Micro Scissors with Round Handle

25°



**FM476R**

45°



**FM477R**

60°



**FM478R**

90°



**FM479R**

125°



**FM480R**

gerade  
straight

aufgebogen  
curved  
on flat

Feines Blatt  
Fine blade



**FM482R**



**FM483R**



**FM484R**



**FM485R**



**FM486R**



**FM488R**



**FM481R**

Sehr feines Blatt  
Delicate blade



**FM489R**



**FM490R**



**FM491R**



**FM492R**



**FM493R**

Sehr feines Blatt,  
1 Blatt mit Knopf  
Delicate blade,  
with 1 probe  
pointed blade



**FM504R**



**FM505R**



**FM506R**



**FM507R**



**FM508R**



**FM503R**

Extrem feines Blatt  
Ultra delicate blade

BC

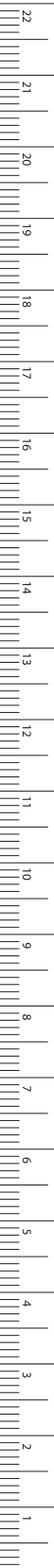

MILLIMETERS

## Scheren – Scissors

Mikro-Federscheren mit Rundgriff

Micro Scissors (Spring Type) with Round Handles

BC

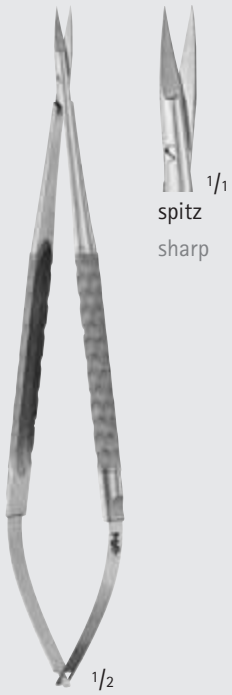

**FM042R**

Mikro-Schere  
Micro scissors  
180 mm, 7"



**FD251R**

Mikro-Schere  
Micro scissors  
180 mm, 7"



**FM043R**

Mikro-Schere  
Micro scissors  
180 mm, 7"



**FD252R**

Mikro-Fadenschere  
für Nahtmaterial von 6/0 und kleiner - 8/0 und kleiner  
Micro ligature scissors  
for suture material 6/0 and smaller - 8/0 and smaller  
180 mm, 7"





## Scheren – Scissors

Feine Scheren – große Ringform  
Delicate Scissors – Large Ring Design

BC

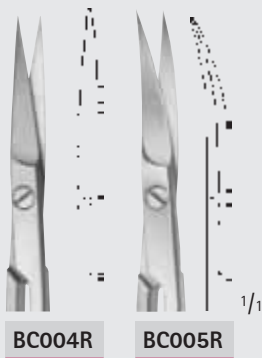

BC004R

BC005R

1/1

BC004R-BC005R

115 mm, 4 1/2"

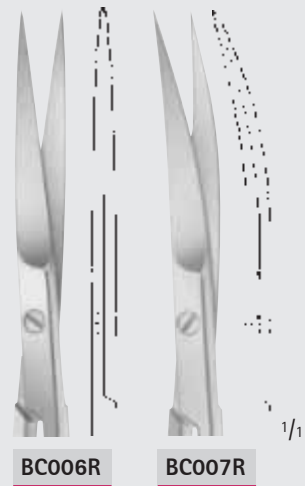

BC006R

BC007R

1/1

JOSEPH

BC006R-BC007R

150 mm, 6"



MILLIMETERS

## Scheren – Scissors

Feine Scheren – große Ringform

Delicate Scissors – Large Ring Design

BC



BC008R

spitz  
sharp



BC009R

spitz  
sharp



BC010R

stumpf  
blunt



BC011R

stumpf  
blunt

1/1

STEVENS

BC008R-BC011R

Präparierscheren

Dissecting scissors

115 mm, 4 1/2"



BC020R

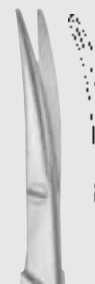

BC021R

1/1

BC020R-BC021R

Präparier- und Strabismusscheren

Dissecting- and strabismus scissors

115 mm, 4 1/2"



BC022R



BC023R

1/1

METZENBAUM

BC022R-BC023R

Präparierscheren

Dissecting scissors

145 mm, 5 3/4"

## Scheren – Scissors

Feine Scheren – große Ringform  
Delicate Scissors – Large Ring Design

BC

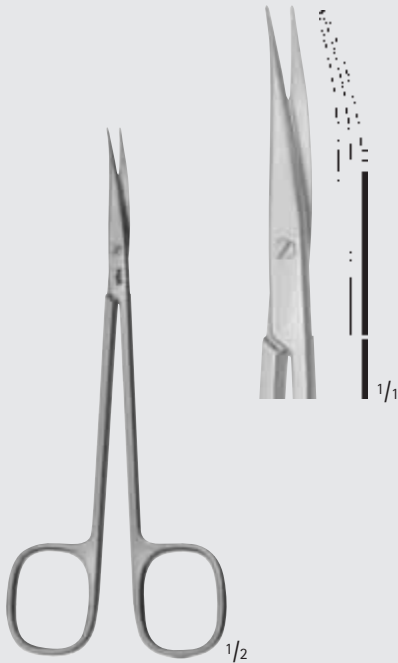

REYNOLDS-JAMESON

**BC015R**

Gefäß-Schere  
Vascular scissors  
140 mm, 5 1/2"

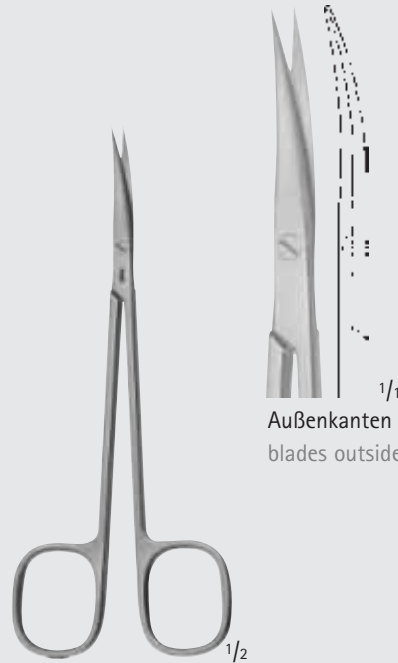

Außenkanten der Blätter halbscharf  
blades outside semi-sharp

**BC017R**

Nerv-Präparierschere  
Nerve dissecting scissors  
140 mm, 5 1/2"



RAGNELL

**BC026R-BC029R**

Besonders flache Spitzen zum Präparieren  
und Unterminieren der Haut  
Special flat points for dissecting and  
undermining the skin

**BC026R**  
135 mm  
5 1/4"

**BC027R**  
135 mm  
5 1/4"

**BC029R**  
150 mm  
6"



MILLIMETERS

# Scheren – Scissors

Feine Scheren

Delicate Scissors

BC

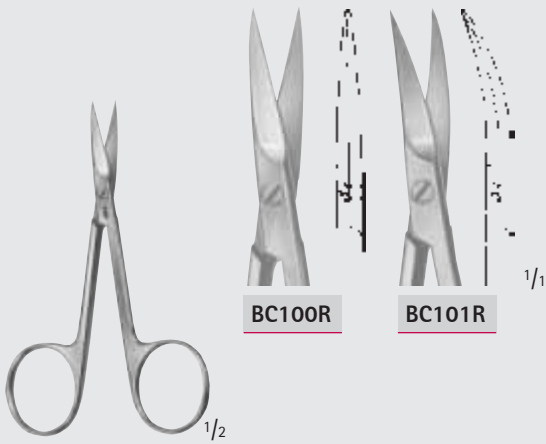

BC100R

BC101R

**BC100R-BC101R**  
90 mm, 3 1/2"



BC056R

BC057R

**BC056R-BC057R**  
90 mm, 3 3/4"

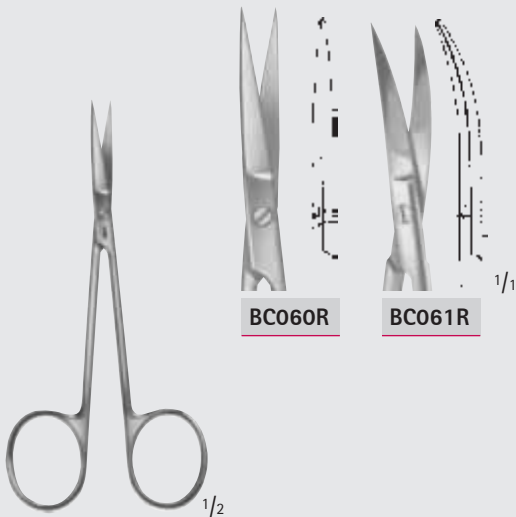

BC060R

BC061R

**BC060R-BC061R**  
105 mm, 4 1/8"



BC064R

BC065R

**BC064R-BC065R**  
120 mm, 4 3/4"



**Scheren – Scissors**  
 Feine Scheren  
 Delicate Scissors

**BC**



**BC110R-BC117R**  
 110 mm, 4 3/8"

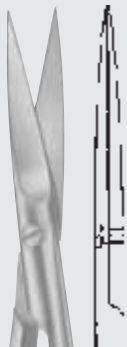

**BC110R**

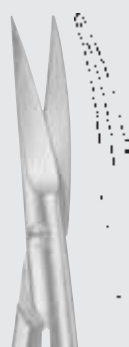

**BC111R**



**BC112R**



**BC113R**



**BC117R**

seitwärts gebogen  
 curved to side

1/1



**BC106R-BC107R**  
 115 mm, 4 1/2"



**BC106R**



**BC107R**

1/1



**DO210R-DO211R**  
 120 mm, 4 3/4"



**DO210R**



**DO211R**

1/1



MILLIMETERS

# Scheren – Scissors

Feine Scheren

Delicate Scissors

BC

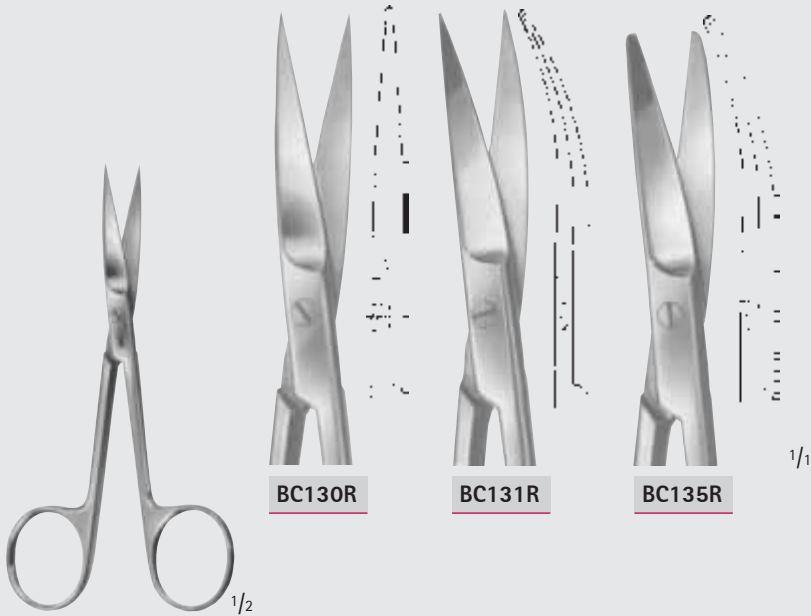

BC130R

BC131R

BC135R

**BC130R-BC135R**  
120 mm, 4 3/4"

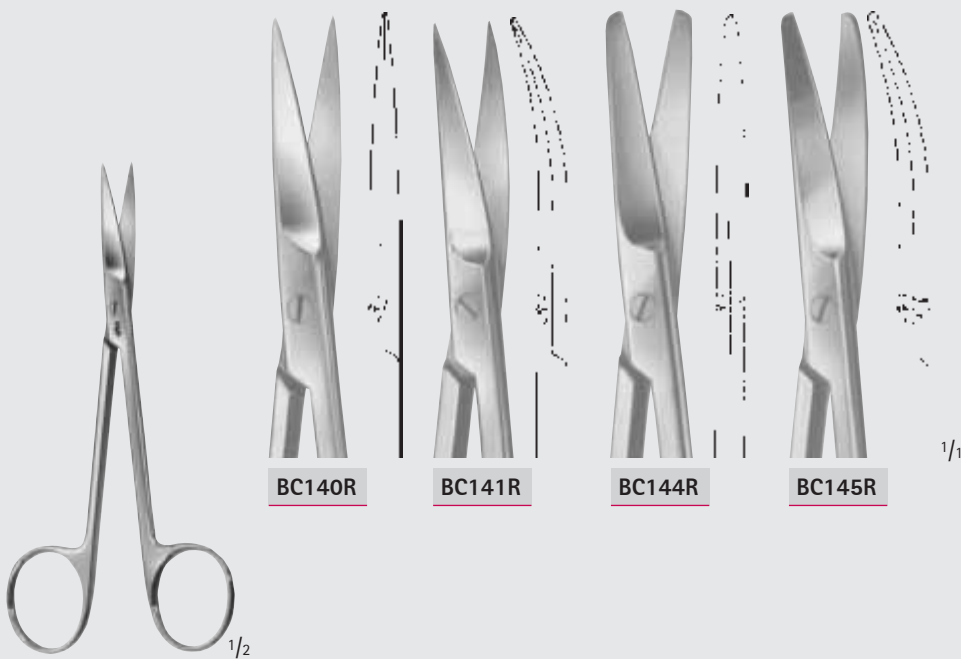

BC140R

BC141R

BC144R

BC145R

**BC140R-BC145R**  
130 mm, 5 1/8"



Scheren – Scissors  
Feine Scheren  
Delicate Scissors

BC

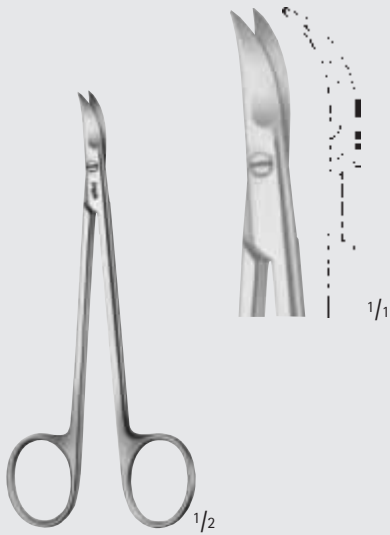

CHADWICK

**BC153R**

115 mm, 4 1/2"



QUINBY

**DO218R**

130 mm, 5 1/8"

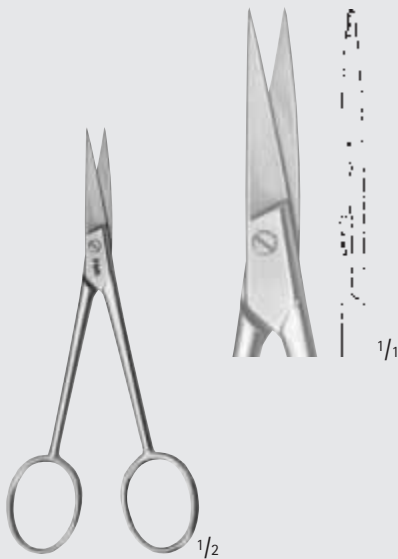

**BC050R**

110 mm, 4 3/8"



MILLIMETERS

## Scheren – Scissors

Feine Scheren

Delicate Scissors

BC



$\frac{1}{1}$   
seitwärts gebogen  
curved to side

PERWITZSCHKY

**OM489R**

Speichelgangschere

Salival scissors

100 mm, 4  $\frac{1}{2}$ "



$\frac{1}{1}$   
seitwärts abgewinkelt  
angled to side

**BC033R**

115 mm, 4  $\frac{1}{2}$ "

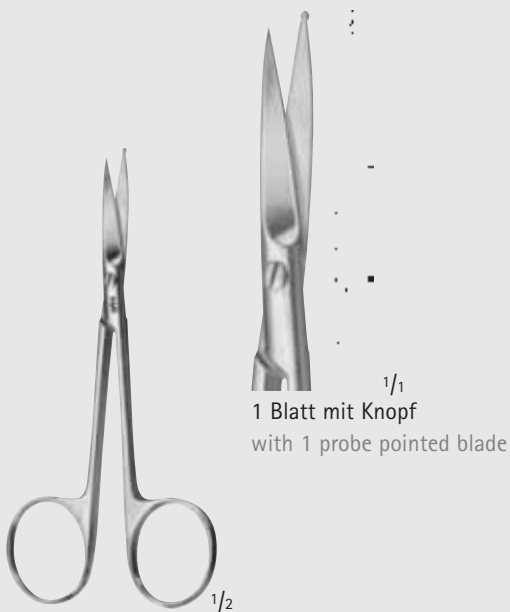

$\frac{1}{1}$   
1 Blatt mit Knopf  
with 1 probe pointed blade

**BC030R**

120 mm, 4  $\frac{3}{4}$ "

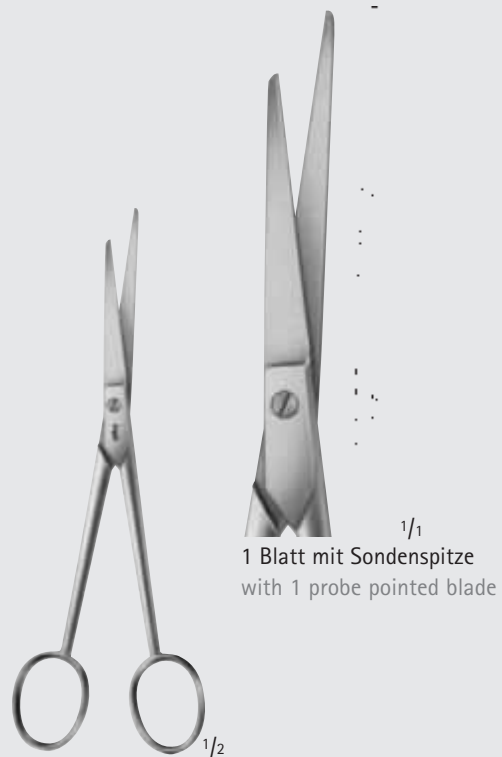

$\frac{1}{1}$   
1 Blatt mit Sondenspitze  
with 1 probe pointed blade

**BC034R**

145 mm, 5  $\frac{3}{4}$ "





**Scheren – Scissors**  
 Feine Scheren  
 Delicate Scissors

**BC**

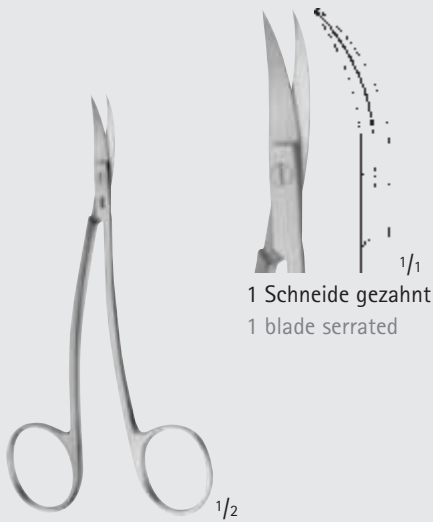

1 Schneide gezahnt  
 1 blade serrated

LA GRANGE

**BC154R**

110 mm, 4 3/8"



abgewinkelt,  
 1 Schneide gezahnt  
 angled on flat,  
 1 blade serrated

**DO252R**

125 mm, 5"

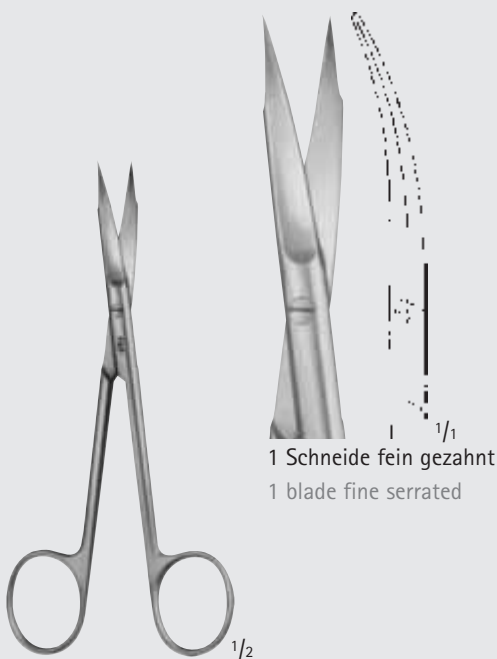

1 Schneide fein gezahnt  
 1 blade fine serrated

**DO251R**

130 mm, 5 1/8"

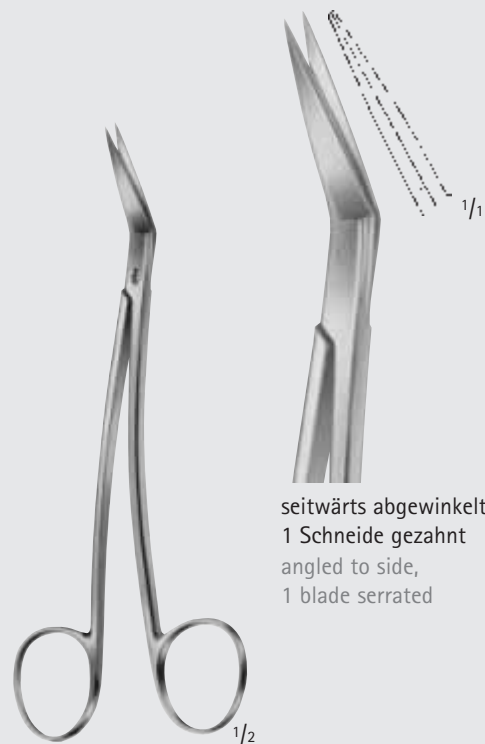

seitwärts abgewinkelt,  
 1 Schneide gezahnt  
 angled to side,  
 1 blade serrated

LOCKLIN

**DO219R**

155 mm, 6"

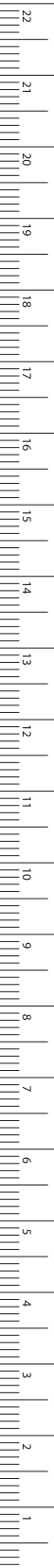

MILLIMETERS

# Scheren – Scissors

Feine Scheren

Delicate Scissors

BC



JOSEPH

**BC156R-BC157R**

150 mm, 6"



**BC156R**

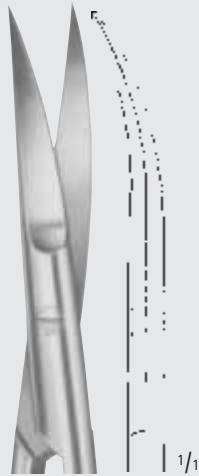

**BC157R**



KELLY

**BC160R-BC161R**

175 mm, 7"

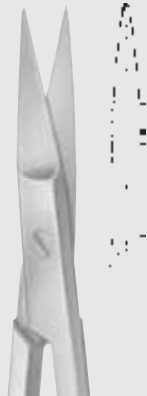

**BC160R**



**BC161R**





**Scheren – Scissors**  
 Chirurgische Scheren  
 Surgical Scissors

**BC**

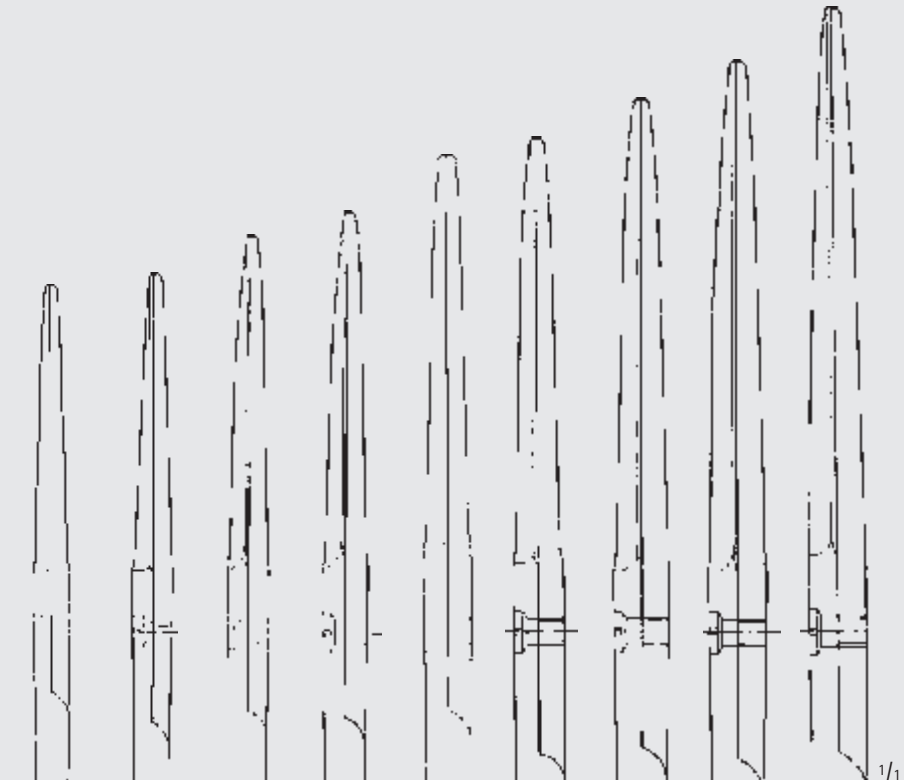

**BC320R-BC330R**  
 Standard-Modelle  
 Standard patterns

BC320R	BC321R	BC323R	BC324R	BC325R	BC326R	BC327R	BC328R	BC330R
105 mm	115 mm	130 mm	145 mm	150 mm	165 mm	175 mm	185 mm	200 mm
4 1/8"	4 1/2"	5 1/8"	5 3/4"	6"	6 1/2"	7"	7 1/4"	8"

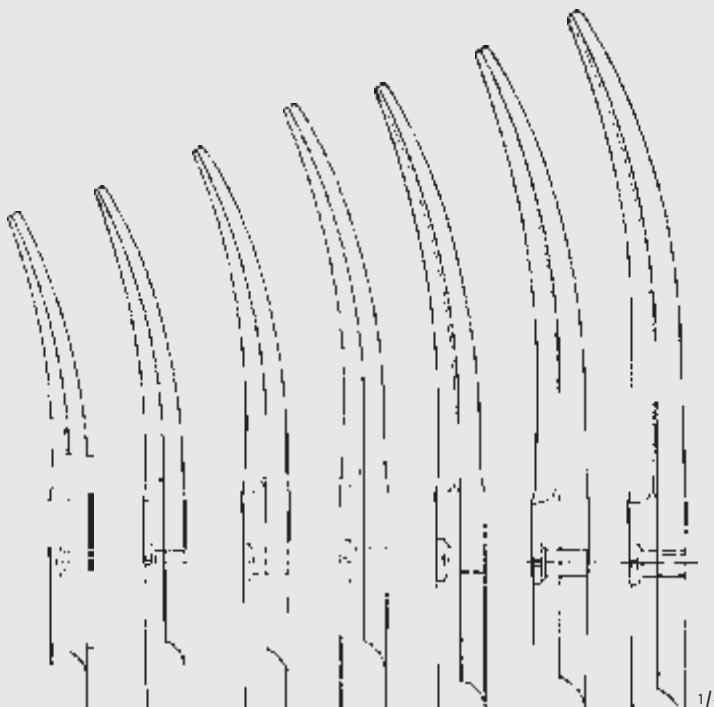

**BC421R-BC428R**  
 Standard-Modelle  
 Standard patterns

BC421R	BC423R	BC424R	BC425R	BC426R	BC427R	BC428R
115 mm	130 mm	145 mm	150 mm	165 mm	175 mm	185 mm
4 1/2"	5 1/8"	5 3/4"	6"	6 1/2"	7"	7 1/4"



MILLIMETERS

**Scheren – Scissors**  
 Chirurgische Scheren  
 Surgical Scissors

BC

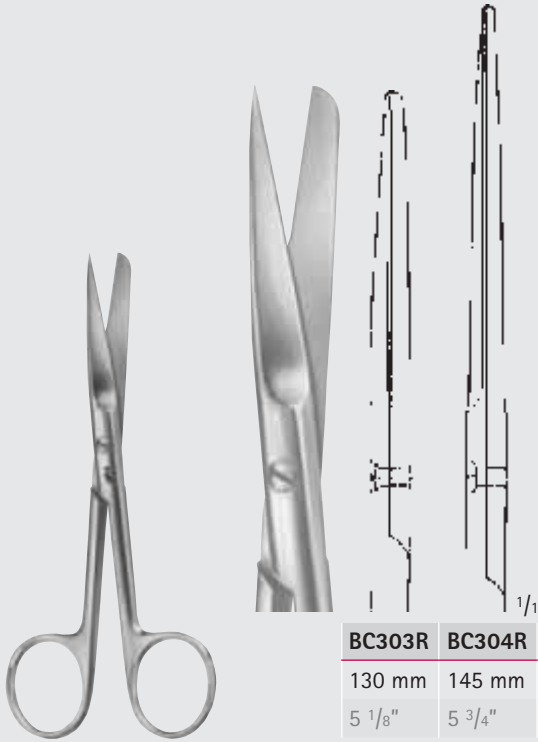

BC303R	BC304R
130 mm	145 mm
5 1/8"	5 3/4"

**BC303R-BC304R**  
 schlanke Modelle  
 slender patterns

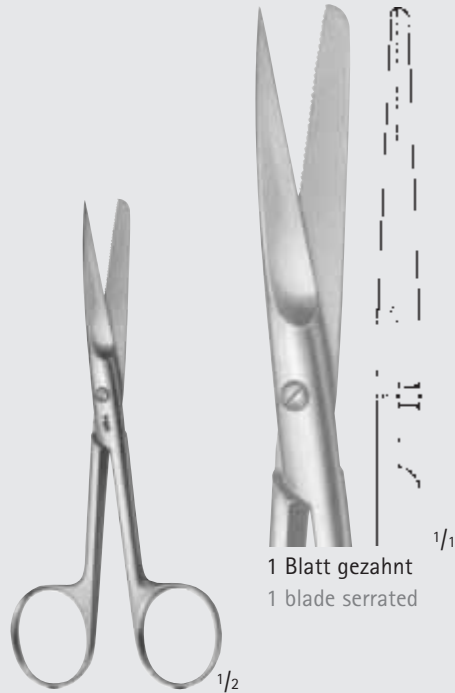

1 Blatt gezahnt  
 1 blade serrated

**BC496R**  
 Wundrandschere  
 Scissors for wound edges  
 130 mm, 5 1/8"

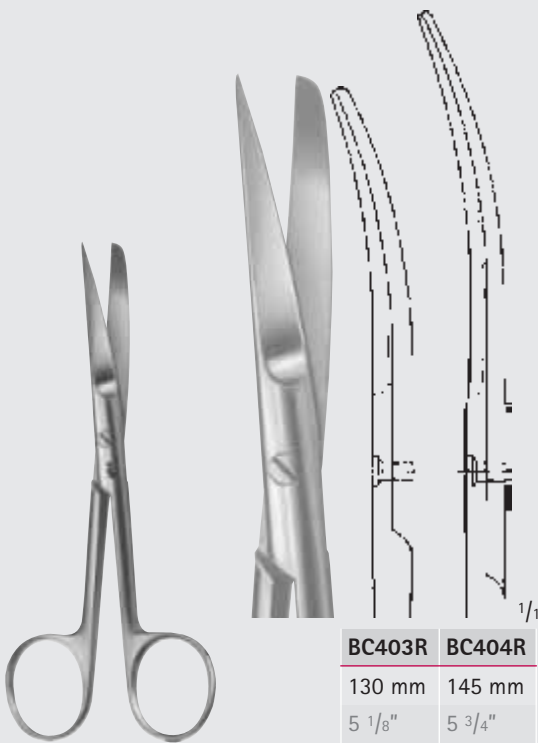

BC403R	BC404R
130 mm	145 mm
5 1/8"	5 3/4"

**BC403R-BC404R**  
 schlanke Modelle  
 slender patterns



1 Blatt gezahnt  
 1 blade serrated

**BC497R**  
 Wundrandschere  
 Scissors for wound edges  
 130 mm, 5 1/8"



**Scheren – Scissors**  
 Chirurgische Scheren  
 Surgical Scissors

**BC**

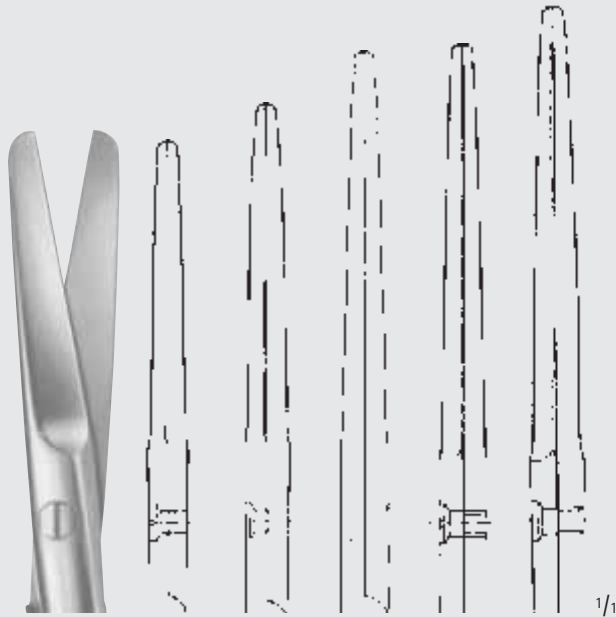

BC313R	BC314R	BC315R	BC316R	BC317R
130 mm	145 mm	150 mm	165 mm	175 mm
5 1/8"	5 3/4"	6"	6 1/2"	7"

**BC313R-BC317R**  
 Standard-Modelle  
 Standard patterns

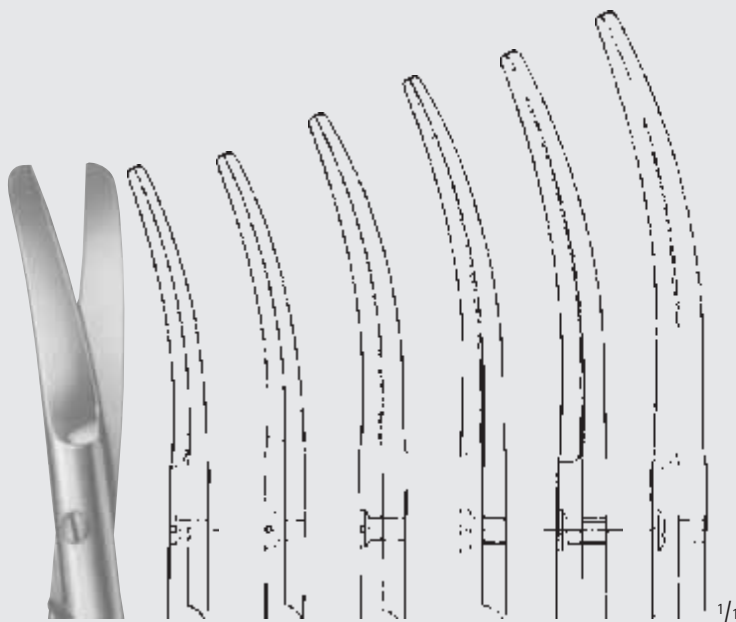

BC411R	BC413R	BC414R	BC415R	BC416R	BC417R
115 mm	130 mm	145 mm	150 mm	165 mm	175 mm
4 1/2"	5 1/8"	5 3/4"	6"	6 1/2"	7"

**COOPER**  
**BC411R-BC417R**  
 Standard-Modelle  
 Standard patterns

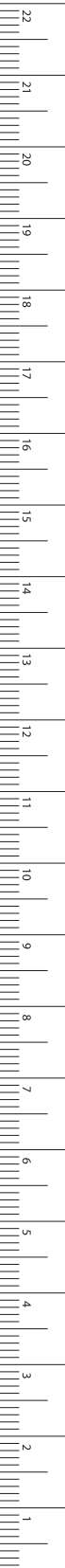

MILLIMETERS

**Scheren – Scissors**  
 Chirurgische Scheren  
 Surgical Scissors

BC

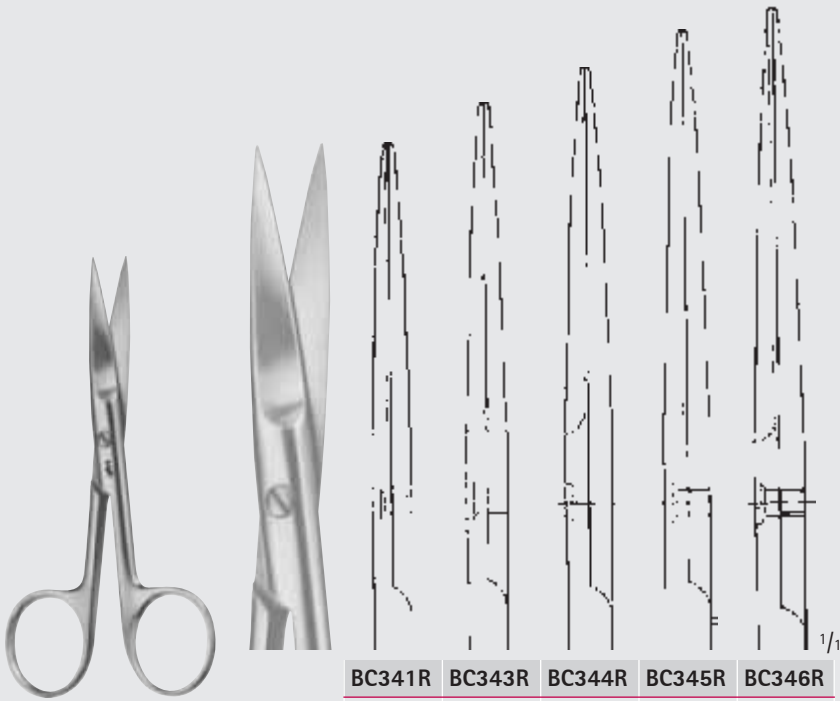

**BC341R-BC346R**  
 Standard-Modelle  
 Standard patterns

BC341R	BC343R	BC344R	BC345R	BC346R
115 mm	130 mm	145 mm	150 mm	165 mm
4 1/2"	5 1/8"	5 3/4"	6"	6 1/2"

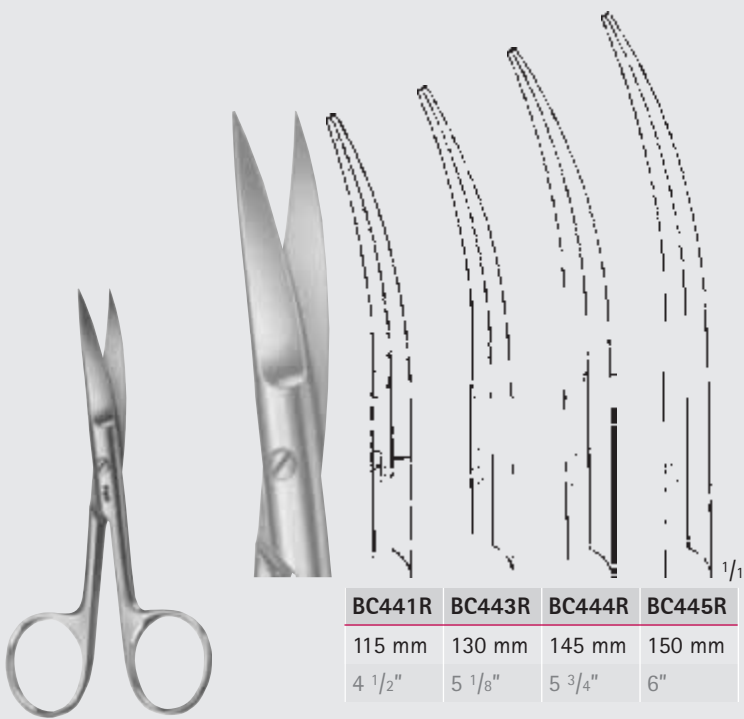

**BC441R-BC445R**  
 Standard-Modelle  
 Standard patterns

BC441R	BC443R	BC444R	BC445R
115 mm	130 mm	145 mm	150 mm
4 1/2"	5 1/8"	5 3/4"	6"



**Scheren – Scissors**  
Chirurgische Scheren  
Surgical Scissors

**BC**

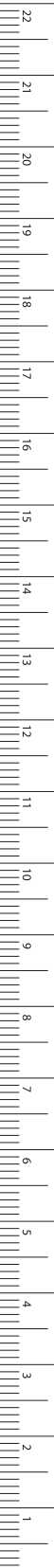

**BC374R**

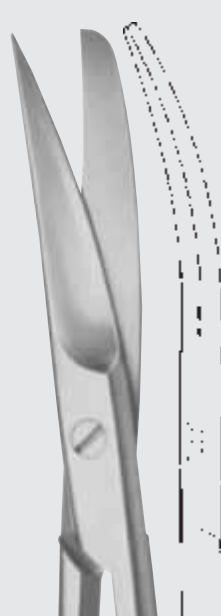

**BC474R**

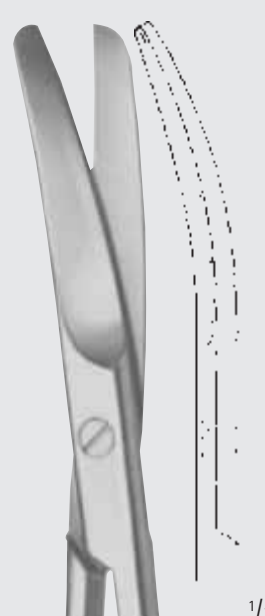

**BC464R**

DEAVER

**BC374R-BC474R**

Chirurgische Scheren mit Flachschluss

Surgical scissors with flat lock

145 mm, 5 3/4"



<b>BC503R</b>	<b>BC504R</b>	<b>BC506R</b>
130 mm	145 mm	165 mm
5 1/8"	5 3/4"	6 1/2"

**BC503R-BC506R**

Inzisions-Scheren

Incision scissors

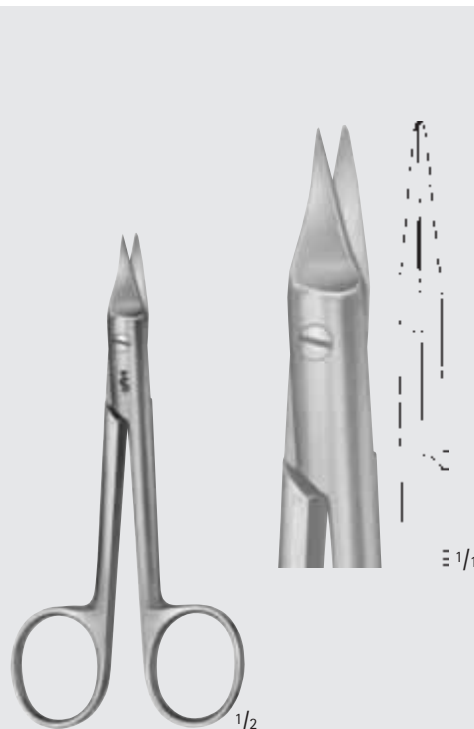

SYSTRUNK

**BC521R**

Nagelspaltschere

Nail splitting scissors

130 mm, 5 1/8"

## Scheren – Scissors

Präparierscheren, feine Modelle

Dissecting Scissors, Delicate Patterns

BC

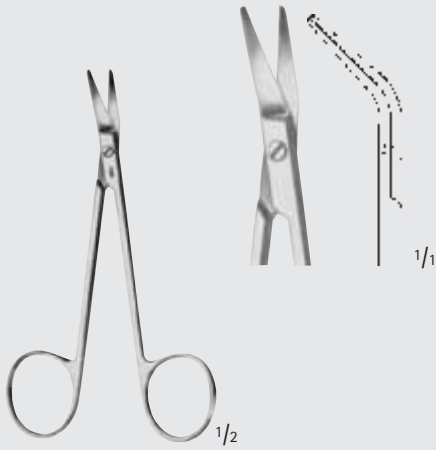

GRAEFE

**OC415R**

Präparierschere

Dissecting scissors

100 mm, 4"

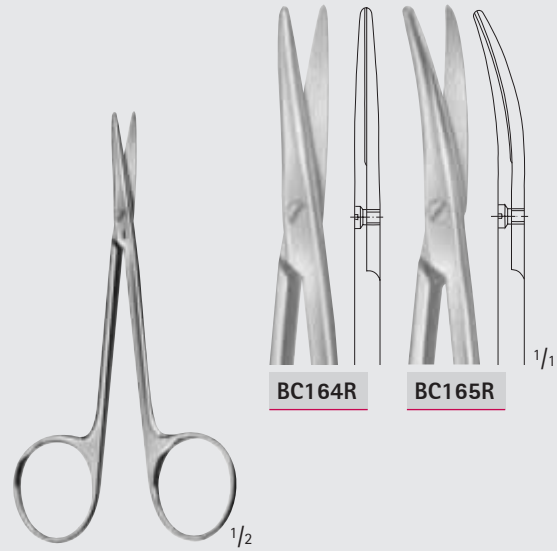

**BC164R**

**BC165R**

**BC164R-BC165R**

Präparierscheren

Dissecting Scissors

115 mm, 4 1/2"

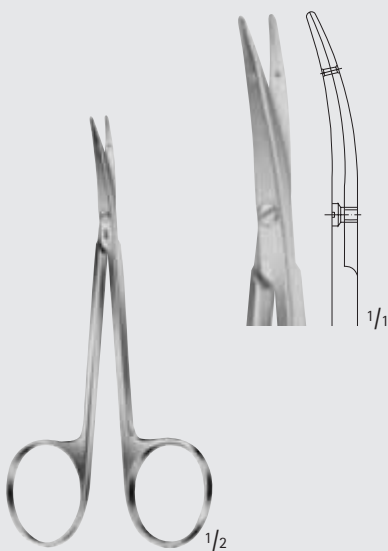

LITTLER

**BC163R**

Präparierschere  
mit Fadenbohrung in der Spitze

Dissecting scissors,  
tips with eye for suture

115 mm, 4 1/2"



COTTLE

**OK374R**

Bulldog-Schere

Bulldog scissors

115 mm, 4 1/2"

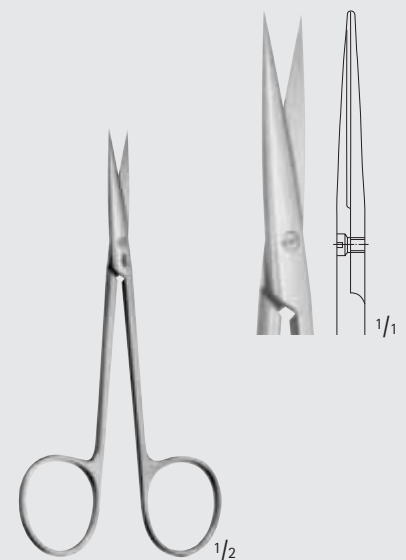

KILNER

**BC162R**

feine Präparierschere

delicate dissecting scissors

115 mm, 4 1/2"





**Scheren – Scissors**  
 Präparierscheren, feine Modelle  
 Dissecting Scissors, Delicate Patterns

BC

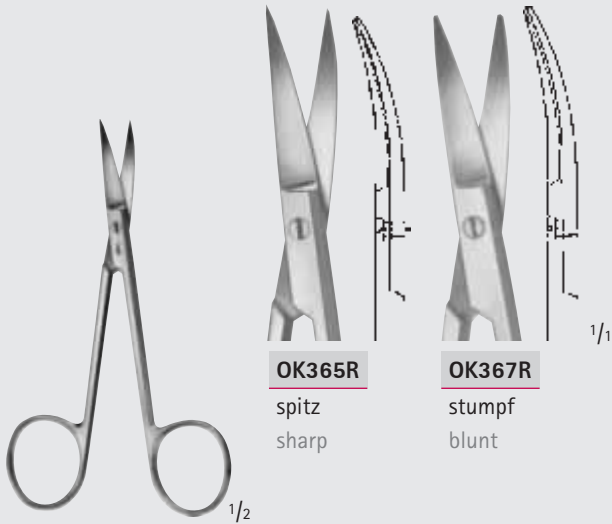

**OK365R**  
 spitz  
 sharp

**OK367R**  
 stumpf  
 blunt

COTTLE-MASING

**OK365R-OK367R**

Scheren für die plastische Chirurgie  
 Scissors for plastic surgery  
 105 mm, 4 1/8"

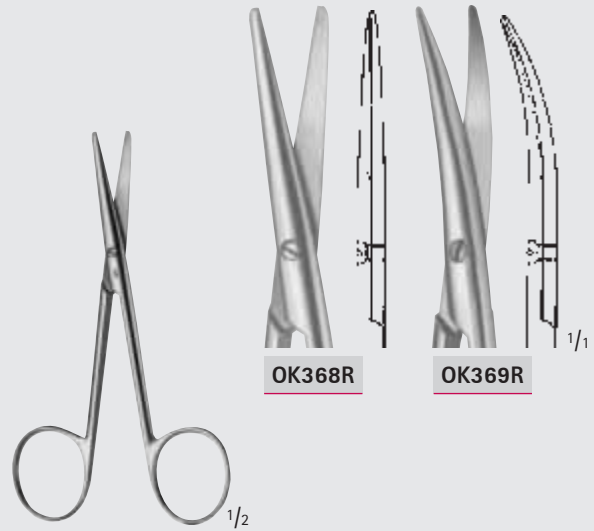

**OK368R**

**OK369R**

COTTLE-KNAPP

**OK368R-OK369R**

Scheren für die plastische Chirurgie  
 Scissors for plastic surgery  
 105 mm, 4 1/8"



**OK372R**  
 135 mm  
 5 1/4"

**OK373R**  
 115 mm  
 4 1/2"

FOMON

**OK372R-OK373R**

Nasenflügelscheren  
 Lower lateral scissors



LANDOLT

**OC430R**

Enukleationsschere  
 Enucleation scissors  
 120 mm, 4 3/4"

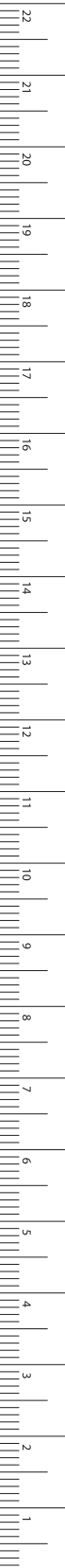

MILLIMETERS

## Scheren – Scissors

Präparierscheren, feine Modelle

Dissecting Scissors, Delicate Patterns

BC

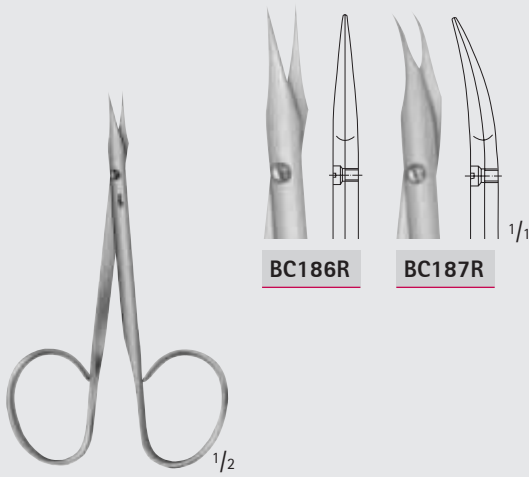

STEVENS

**BC186R-BC187R**

Gefäß- und Sehnscheren  
Vascular- and tendon scissors  
100 mm, 4"

»grazil«

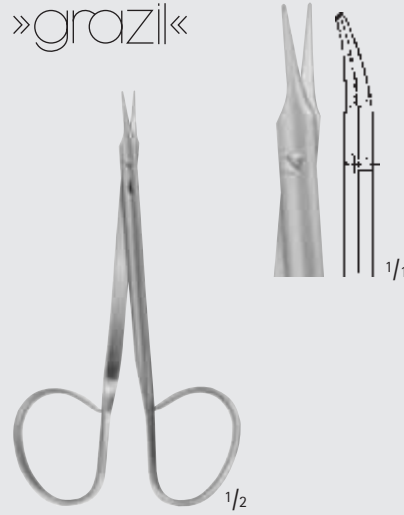

STEVENS

**OK366R**

feine Präparierschere  
delicate dissecting scissors  
110 mm, 4 3/8"

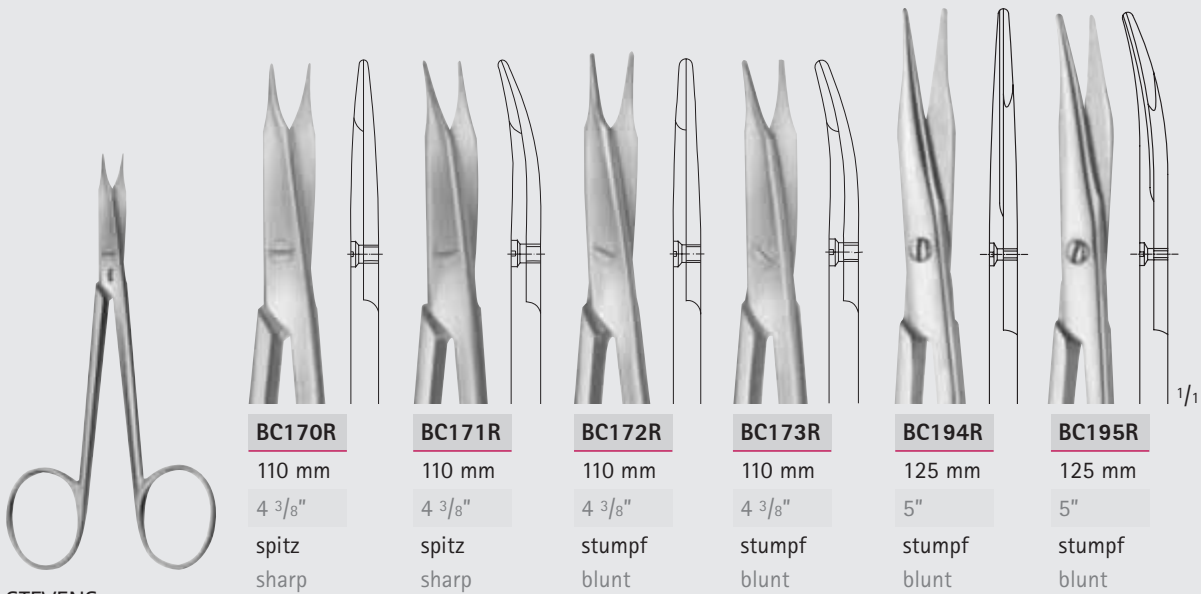

STEVENS

**BC170R-BC195R**

Gefäß- und Sehnscheren  
Vascular- and tendon scissors

**BC170R**

110 mm

4 3/8"

spitz  
sharp

**BC171R**

110 mm

4 3/8"

spitz  
sharp

**BC172R**

110 mm

4 3/8"

stumpf  
blunt

**BC173R**

110 mm

4 3/8"

stumpf  
blunt

**BC194R**

125 mm

5"

stumpf  
blunt

**BC195R**

125 mm

5"

stumpf  
blunt



## Scheren – Scissors

Präparierscheren, feine Modelle  
Dissecting Scissors, Delicate Patterns

BC

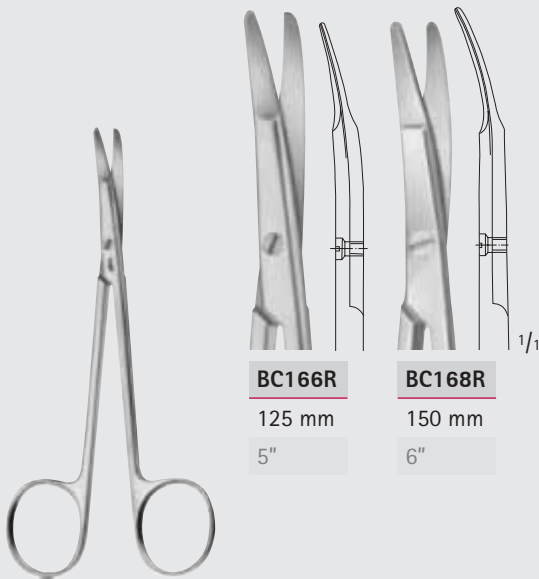

**BC166R**

125 mm

5"

**BC168R**

150 mm

6"

KILNER

**BC166R-BC168R**

besonders flache Spitzen zum Präparieren  
und Unterminieren der Haut  
special flat points for dissecting and  
undermining the skin

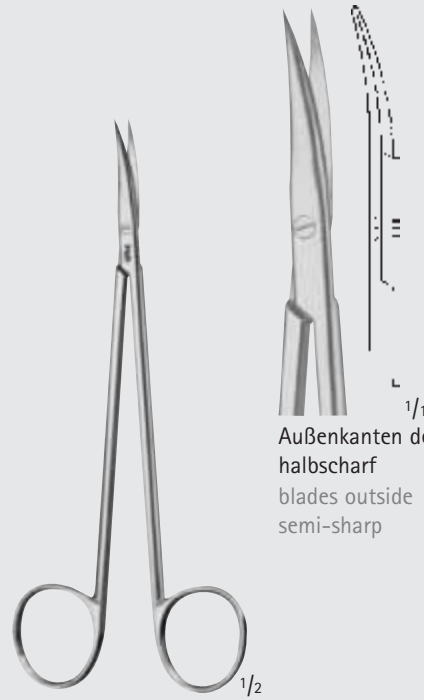

Außenkanten der Blätter  
halbscharf  
blades outside  
semi-sharp

**BC628R**

Nerv-Präparierschere  
Nerve dissecting scissors  
150 mm, 6"

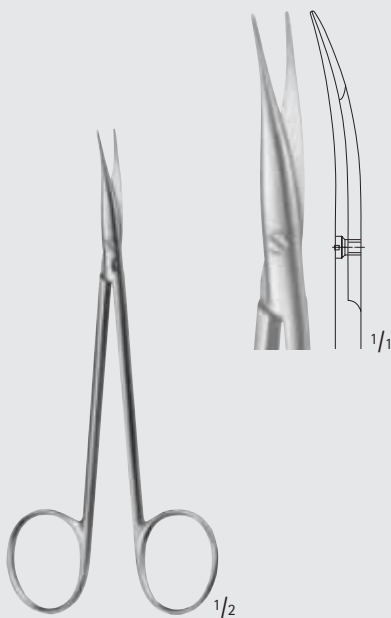

JAMESON-WERBER

**BC175R**

Präparierschere  
Dissecting scissors  
130 mm, 5 1/8"

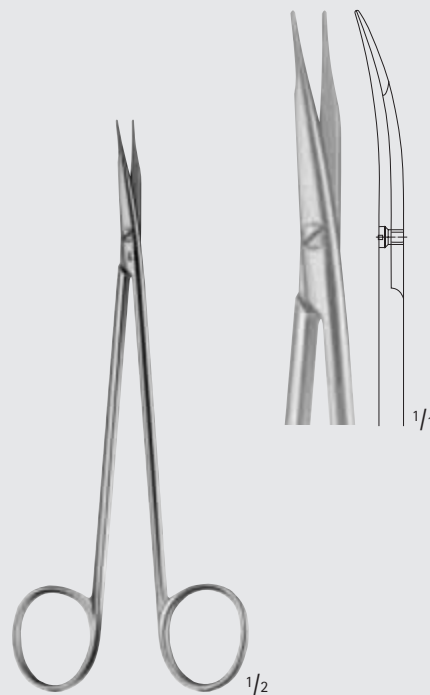

JAMESON

**BC177R**

Präparierschere  
Dissecting scissors  
150 mm, 6"



MILLIMETERS

## Scheren – Scissors

Präparierscheren, feine Modelle

Dissecting Scissors, Delicate Patterns

BC



BC180R	BC181R
145 mm	175 mm
5 3/4"	7"

REYNOLDS

**BC180R-BC181R**

Präparierscheren  
Dissecting scissors

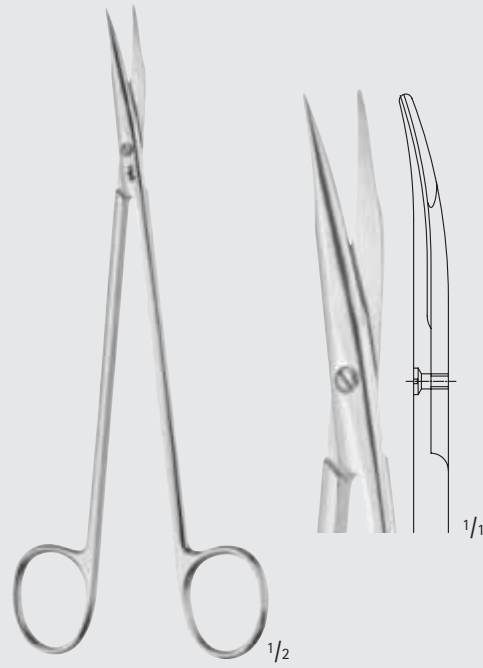

POTTS

**BC178R**

Präparierschere  
Dissecting scissors  
180 mm, 7"

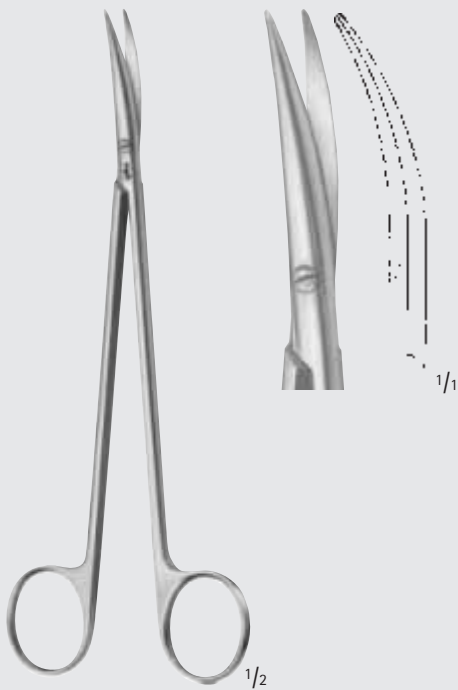

DE BAKEY

**BC629R**

Arteriotomie-Schere  
Arteriotomy scissors  
175 mm, 7"

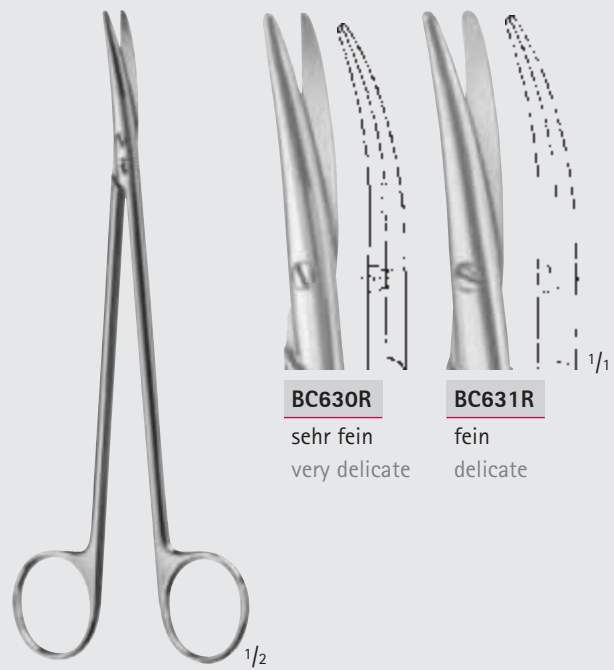

**BC630R**

sehr fein  
very delicate

**BC631R**

fein  
delicate

TÖNNIS-ADSON

**BC630R-BC631R**

Präparierscheren  
Dissecting scissors  
175 mm, 7"



**Scheren – Scissors**  
 Präparierscheren, feine Modelle  
 Dissecting Scissors, Delicate Patterns

**BC**

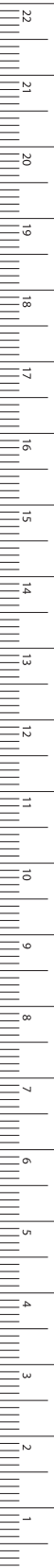

1/2



**BC633R**

sehr fein  
very delicate



**BC634R**

fein  
delicate



**BC635R**

fein  
delicate

1/1

**TÖNNIS**

**BC633R-BC635R**

Präparierscheren  
Dissecting scissors  
180 mm, 7"

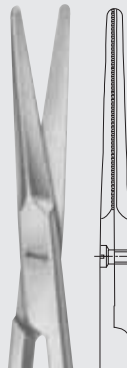

**BC184R**

125 mm  
5"

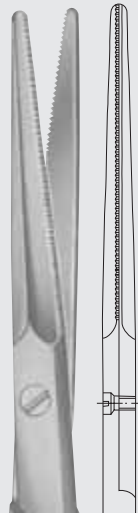

**BC188R**

195 mm  
7 3/4"

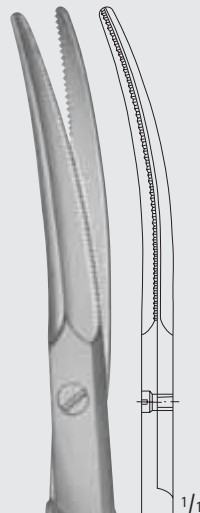

**BC189R**

195 mm  
7 3/4"

1/1

**GORNEY**

**BC184R-BC189R**

Präparierscheren für plastische Chirurgie  
 Schneiden: außen halbscharf  
 innen fein gezahnt  
 Dissection scissors for plastic surgery  
 Blades: outside semi-sharp  
 inside fine serrated

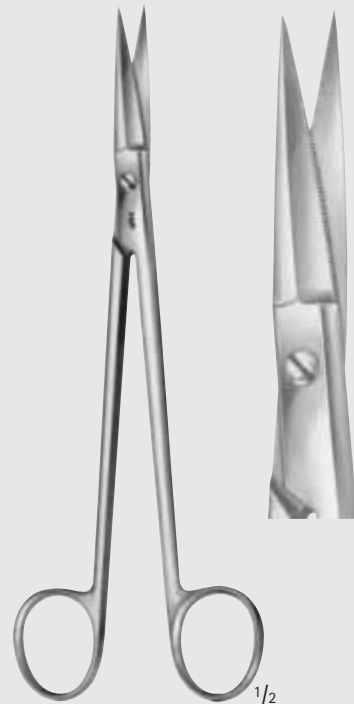

1/2

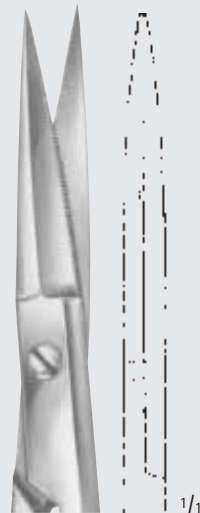

1/1

**BC672R**

Knorpelschere,  
Blätter außen und innen schneidend  
Cartilage scissors,  
blades cutting on both sides  
185 mm, 7 1/4"

MILLIMETERS

## Scheren – Scissors

Chirurgische und Präparierscheren  
Surgical and Dissecting Scissors

BC



MAYO

BC544R-BC557R

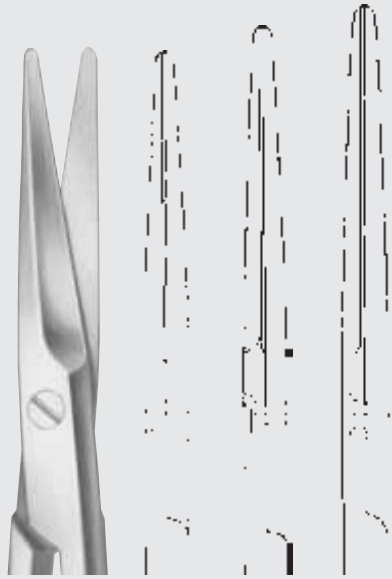

BC544R	BC545R	BC547R
140 mm	155 mm	170 mm
5 1/2"	6"	6 3/4"



BC554R	BC555R	BC557R
140 mm	155 mm	170 mm
5 1/2"	6"	6 3/4"



MAYO-STILLE

BC570R-BC575R

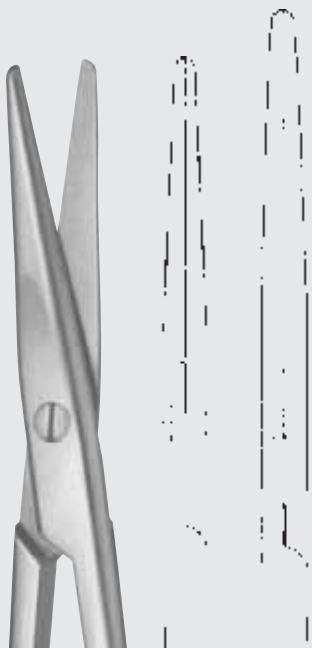

BC570R	BC572R
140 mm	170 mm
5 1/2"	6 3/4"



BC573R	BC575R
140 mm	170 mm
5 1/2"	6 3/4"



**Scheren – Scissors**  
 Präparierscheren  
 Dissecting Scissors

**BC**

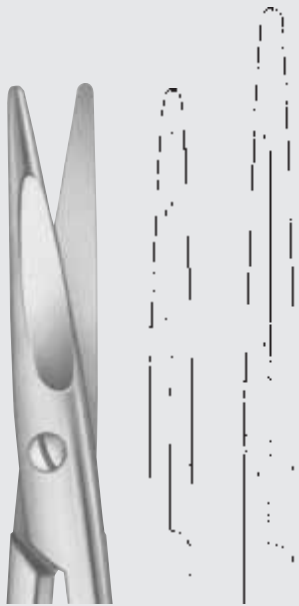
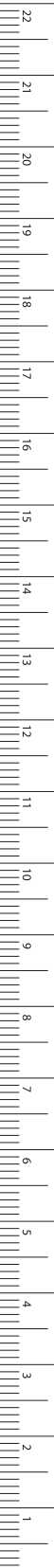

BC576R	BC578R
140 mm	170 mm
5 1/2"	6 3/4"

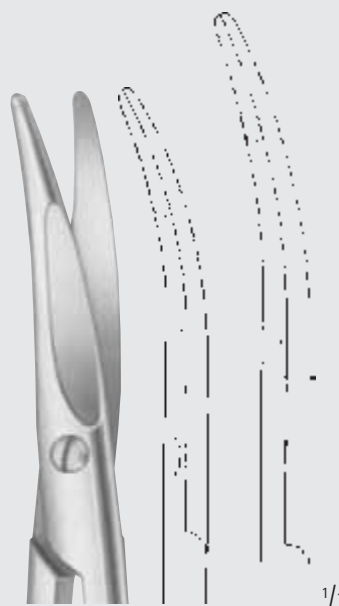

BC577R	BC579R
140 mm	170 mm
5 1/2"	6 3/4"

MAYO-STILLE

**BC576R-BC579R**

mit abgeschägten Schneiden  
 with chamfered blades

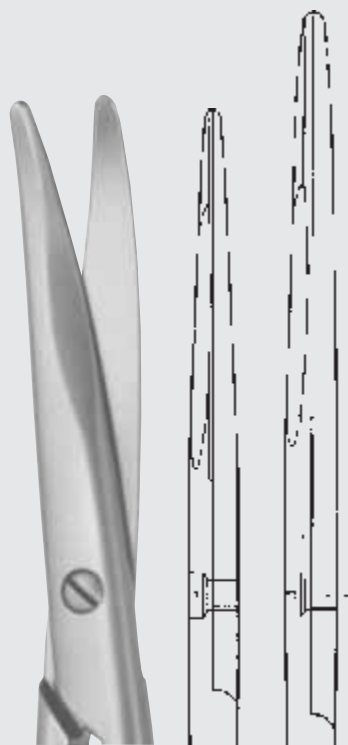

BC562R	BC564R
190 mm	215 mm
7 1/2"	8 1/2"



BC563R	BC565R
190 mm	215 mm
7 1/2"	8 1/2"

MAYO

**BC562R-BC565R**

mit abgeschägten Schneiden  
 with chamfered blades

MILLIMETERS

**Scheren – Scissors**  
 Präparierscheren  
 Dissecting Scissors

BC



1/2



BC566R

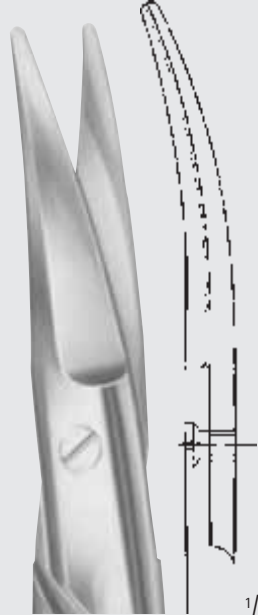

1/1

BC569R

MAYO-NOBLE

BC566R-BC569R

breite Modelle  
 broad patterns  
 170 mm, 6 3/4"

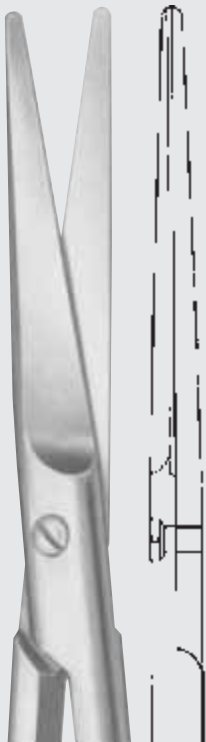

BC560R



1/1

BC561R

MAYO-HARRINGTON

BC560R-BC561R

230 mm, 9"





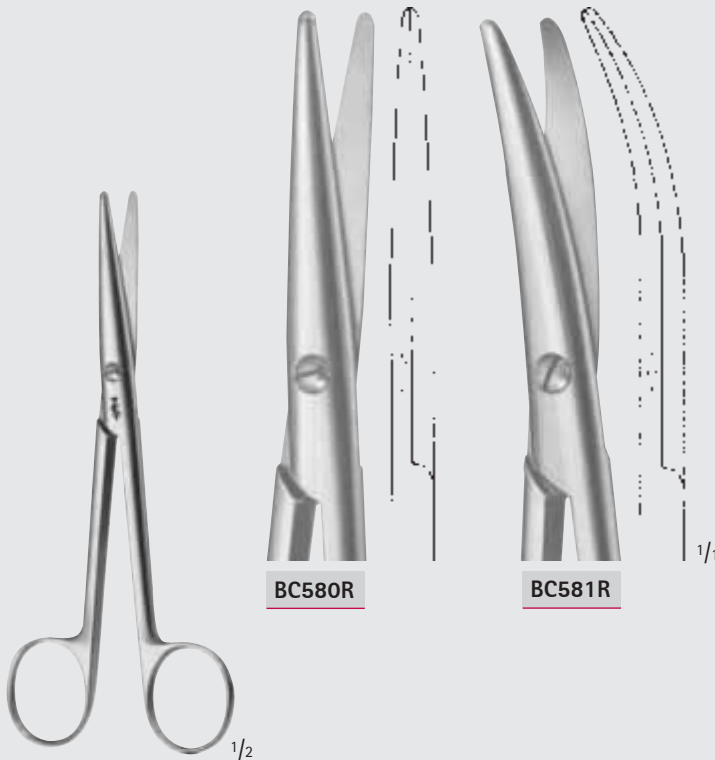
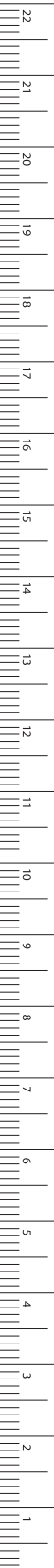

BC580R

BC581R

STILLE

BC580R-BC581R

150 mm, 6"



BC590R

BC591R

LEXER

BC590R-BC591R

schmal  
 narrow  
 165 mm, 6 1/2"

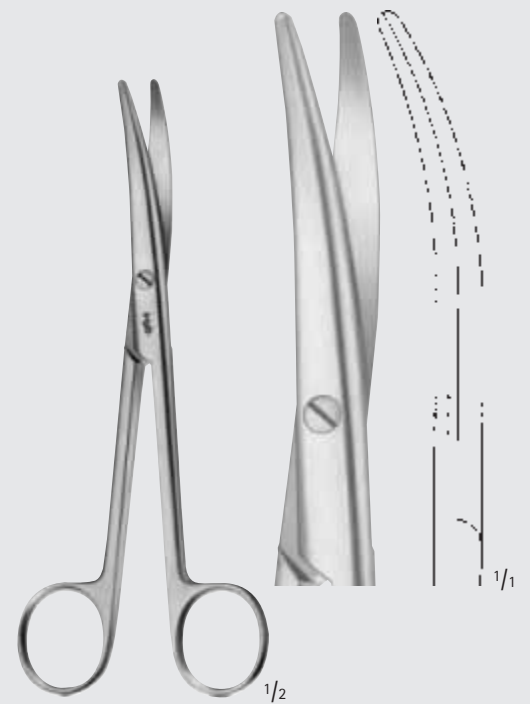

MAYO-LEXER

BC592R

Standard-Modell  
 Standard pattern  
 165 mm, 6 1/2"

**Scheren – Scissors**  
 Präparierscheren  
 Dissecting Scissors

BC



BC584R	BC585R
165 mm	200 mm
6 1/2"	8"



BC587R	BC588R	BC589R
165 mm	200 mm	210 mm
6 1/2"	8"	8 1/4"



MAYO

BC584R-BC589R



**Scheren – Scissors**  
 Präparierscheren  
 Dissecting Scissors

**BC**

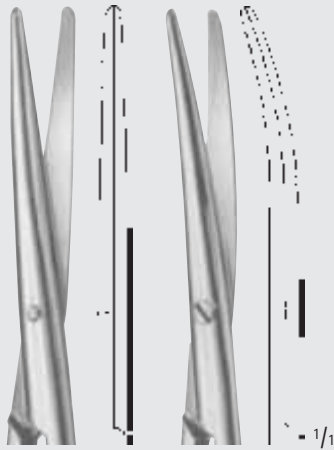

**BC600R**

**BC603R**

BABY-METZENBAUM

**BC600R-BC603R**

145 mm, 5 3/4"

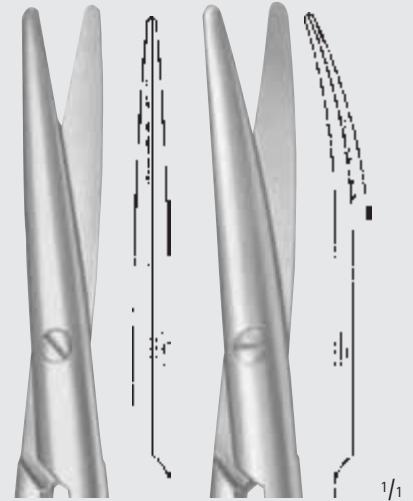

**BC680R**

200 mm

8"

**BC683R**

160 mm

6 1/4"

METZENBAUM

**BC680R-BC683R**

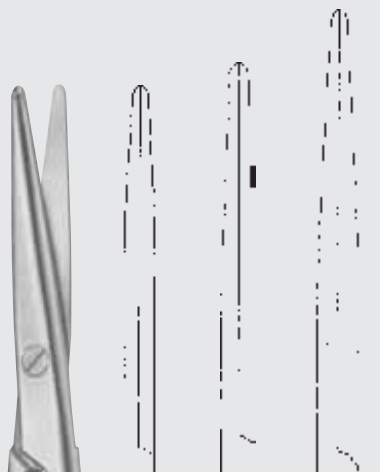

**BC601R**

145 mm

5 3/4"

**BC602R**

180 mm

7"

**BC604R**

200 mm

8"

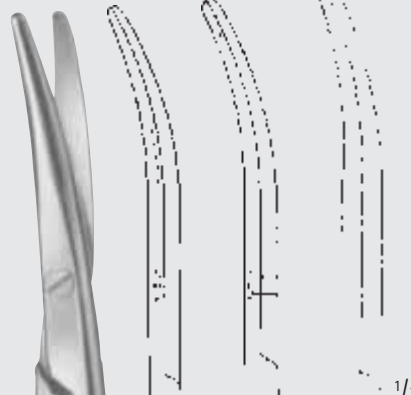

**BC605R**

145 mm

5 3/4"

**BC606R**

180 mm

7"

**BC607R**

200 mm

8"

METZENBAUM

**BC601R-BC607R**



MILLIMETERS

**Scheren – Scissors**  
 Präparierscheren  
 Dissecting Scissors

BC

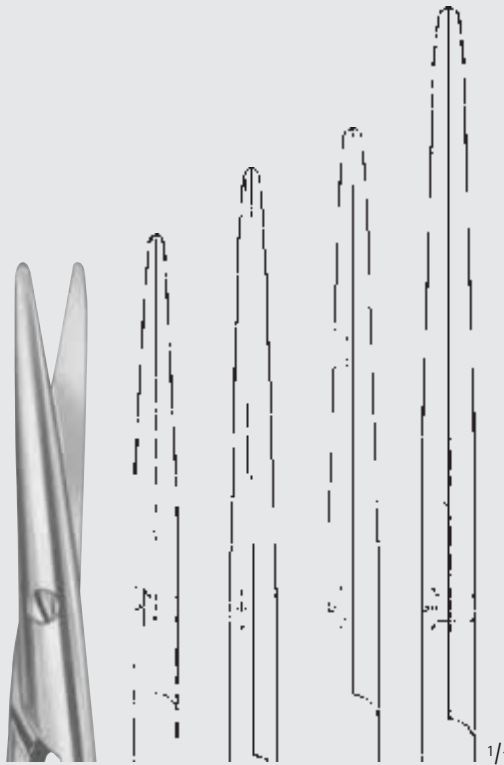

BC611R	BC612R	BC613R	BC614R
230 mm	250 mm	280 mm	305 mm
9"	10"	11"	12"



NELSON-METZENBAUM

BC611R-BC625R

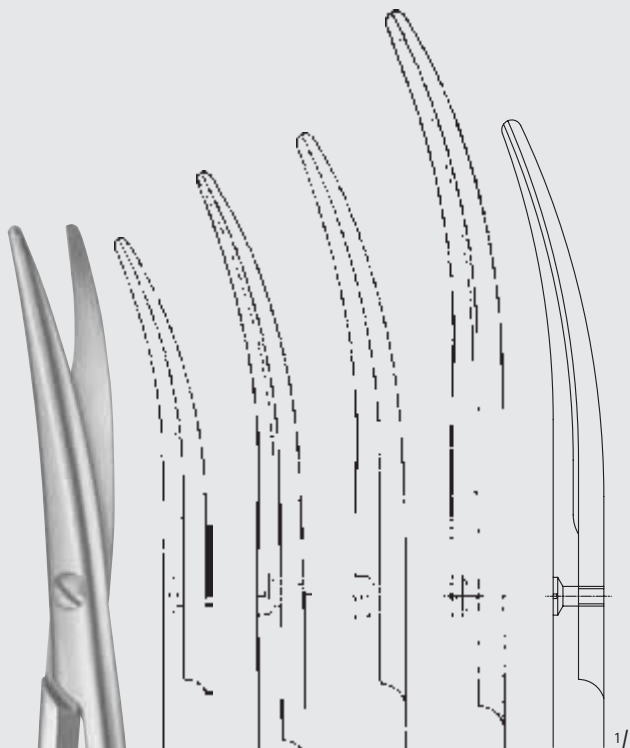

BC615R	BC616R	BC618R	BC619R	BC625R
230 mm	250 mm	280 mm	305 mm	350 mm
9"	10"	11"	12"	14"

## Scheren – Scissors

Präparierscheren, Kapselscheren  
Dissecting Scissors, Cartilage Scissors

BC

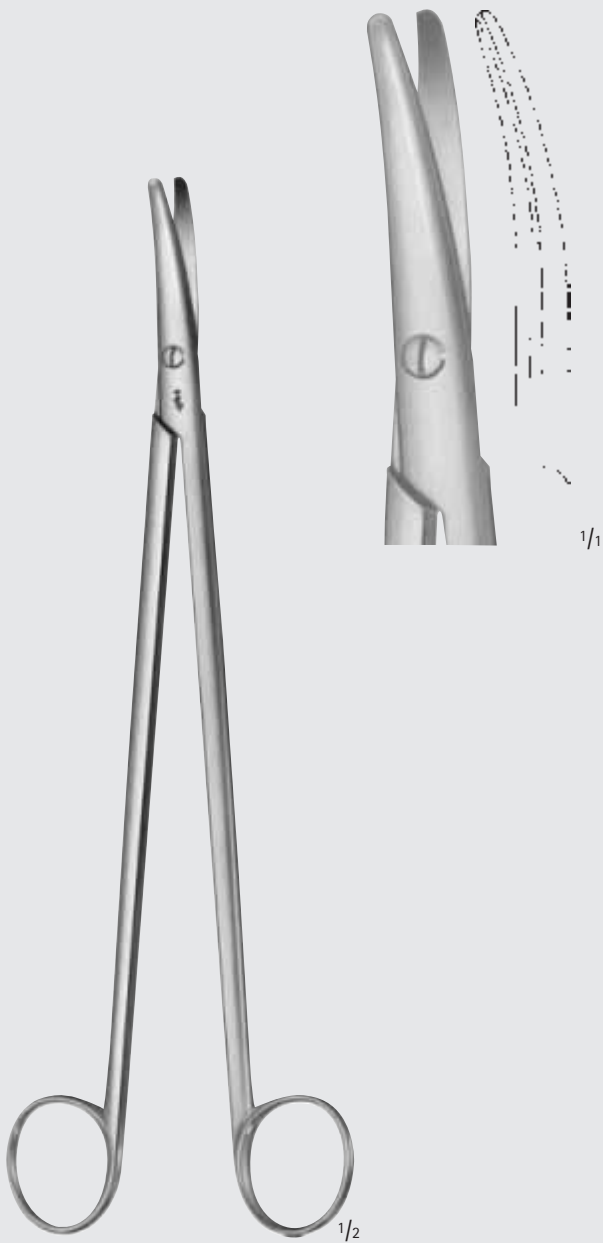

WELLER

**BC620R**

Präparierschere, kräftiges Modell  
Dissecting scissors, heavy pattern  
280 mm, 11"



RESANO

**BC595R**

Kapselschere  
Cartilage scissors  
250 mm, 10"

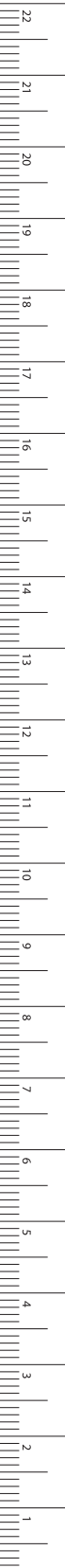

**Scheren – Scissors**  
 SuperCut Scheren  
 SuperCut Scissors

**BC**

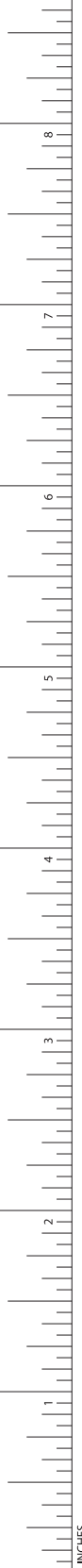

BC900R	BC901R
spitz sharp	spitz sharp

**BC900R-BC901R**  
 110 mm, 4 3/8"

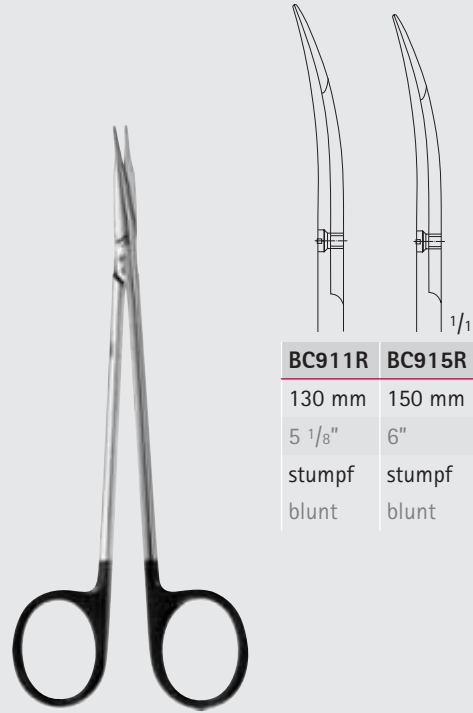

BC911R	BC915R
130 mm	150 mm
5 1/8"	6"
stumpf blunt	stumpf blunt

**JAMESON**  
**BC911R-BC915R**



BC916R	BC917R
spitz sharp	spitz sharp

**JOSEPH**  
**BC916R-BC917R**  
 150 mm, 6"

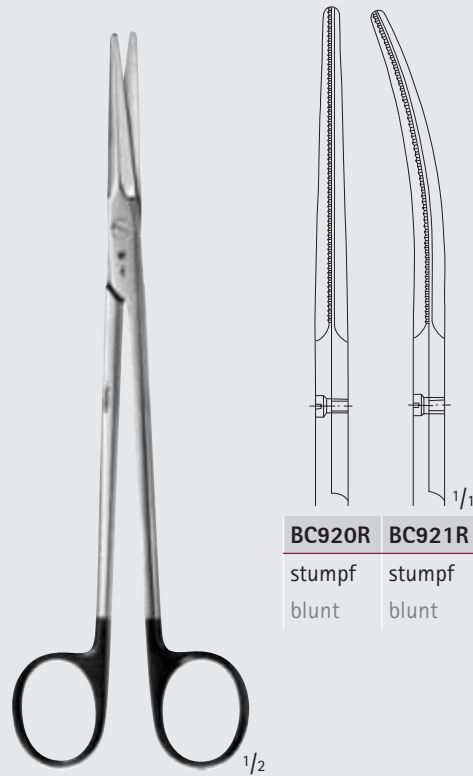

BC920R	BC921R
stumpf blunt	stumpf blunt

**GORNEY**  
**BC920R-BC921R**  
 195 mm, 7 3/4"



**Scheren – Scissors**  
 SuperCut Scheren  
 SuperCut Scissors

**BC**



**BC924R BC925R**

MAYO

**BC924R-BC925R**

165 mm, 6 1/2"

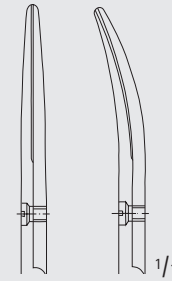

**BC930R BC931R**

BABY-METZENBAUM

**BC930R-BC931R**

115 mm, 4 1/2"



**BC934R BC937R**

145 mm 180 mm

5 3/4" 7"

METZENBAUM

**BC934R-BC937R**

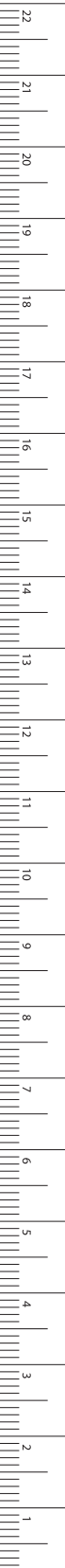

MILLIMETERS

## Scheren – Scissors

DUROTIP® Feine Scheren

DUROTIP® Delicate Scissors



DUROTIP®-Scheren  
mit eingesetzten Hartmetall-Schneiden

- 3 Jahre Garantie!
- Hervorragende Schnitthaltigkeit
- Lange Lebensdauer
- Vergoldete Ring

DUROTIP® Scissors  
with inserted carbide cutting edges

- 3 years guarantee!
- Excellent cutting accuracy
- Long working life
- Gold-plated rings

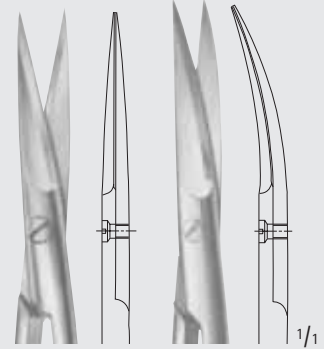

BC210R

BC211R



BC210R-BC211R

Fadenscheren  
Ligature scissors  
110 mm, 4 3/8"



1 Schneide gezahnt  
1 blade serrated



GOLDMAN-FOX

DO250R

130 mm, 5 1/8"

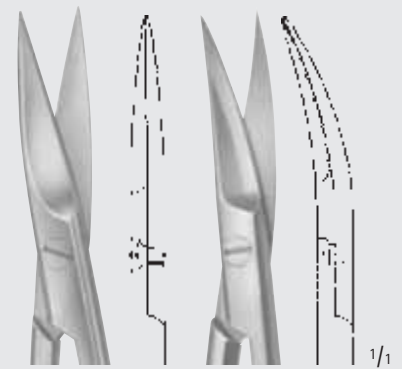

DO208R

DO209R



DO208R-DO209R

120 mm, 4 3/4"

BC





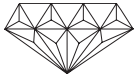

**Scheren – Scissors**  
 DUROTIP® Chirurgische Scheren  
 DUROTIP® Surgical Scissors

**BC**

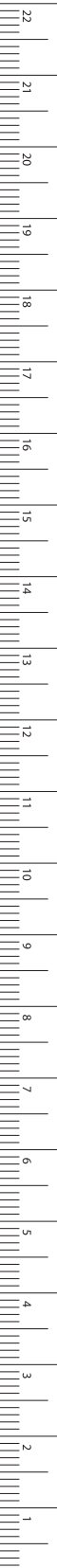

1/2

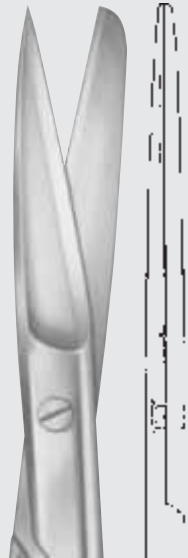

**BC224R**

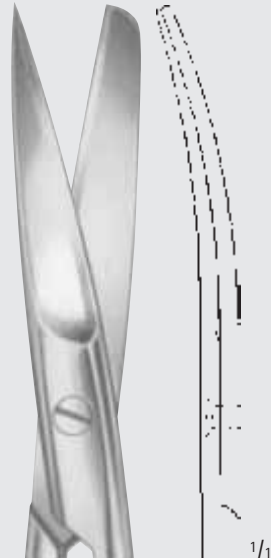

**BC234R**

1/1

**BC224R-BC234R**

145 mm, 5 3/4"



1/2

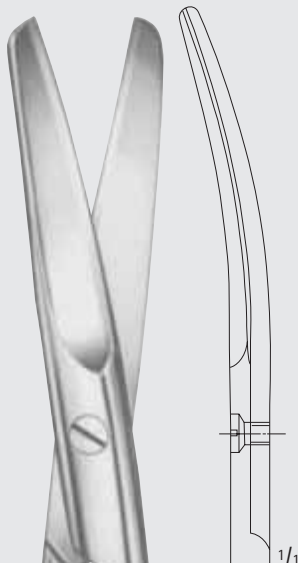

1/1

**BC231R**

145 mm, 5 3/4"

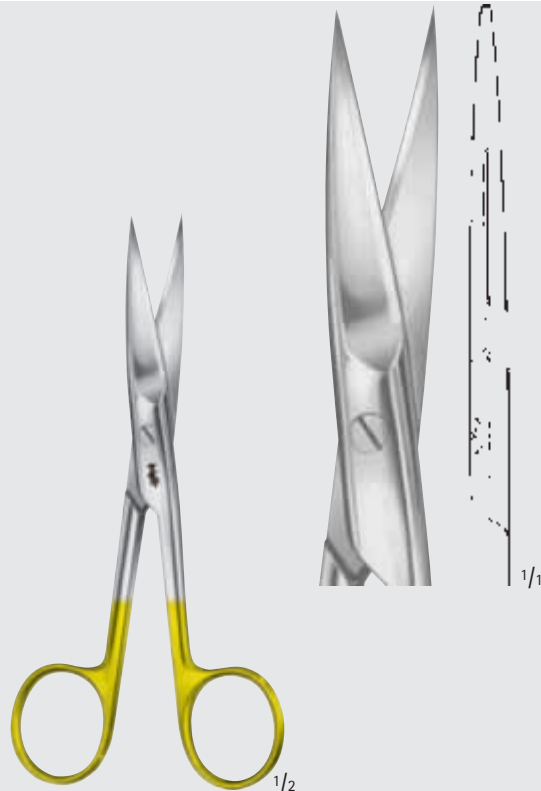

1/2

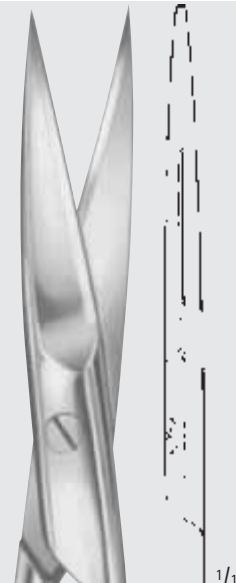

1/1

**BC228R**

145 mm, 5 3/4"

MILLIMETERS

## Scheren – Scissors

DUROTIP® Präparierscheren

DUROTIP® Dissecting Scissors

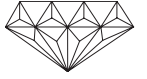

BC



MAYO

**BC250R-BC253R**



BC250R	BC252R
140 mm	170 mm
5 1/2"	6 3/4"



BC251R	BC253R
140 mm	170 mm
5 1/2"	6 3/4"



MAYO

**BC242R-BC559R**



BC242R	BC558R
170 mm	230 mm
6 3/4"	9"



BC243R	BC559R
170 mm	230 mm
6 3/4"	9"



**LEXER**  
**BC283R**  
 schmal  
 narrow  
 165 mm, 6 1/2"

**MAYO-LEXER**  
**BC284R**  
 165 mm, 6 1/2"

**BC256R-BC257R**  
 115 mm, 4 1/2"



MILLIMETERS

**Scheren – Scissors**  
DUROTIP® Präparierscheren  
DUROTIP® Dissecting Scissors



BC

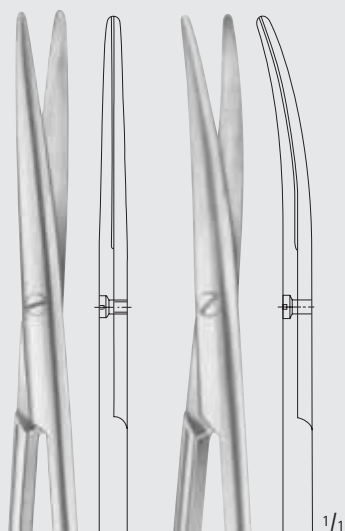

BC258R

BC259R

BABY-METZENBAUM

BC258R-BC259R

145 mm, 5 3/4"

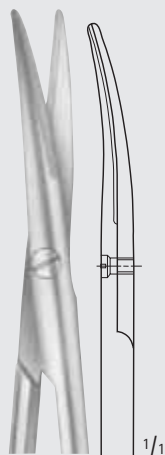

TÖNNIS-ADSON

BC273R

175 mm, 7"



**METZENBAUM**

**BC270R-BC277R**

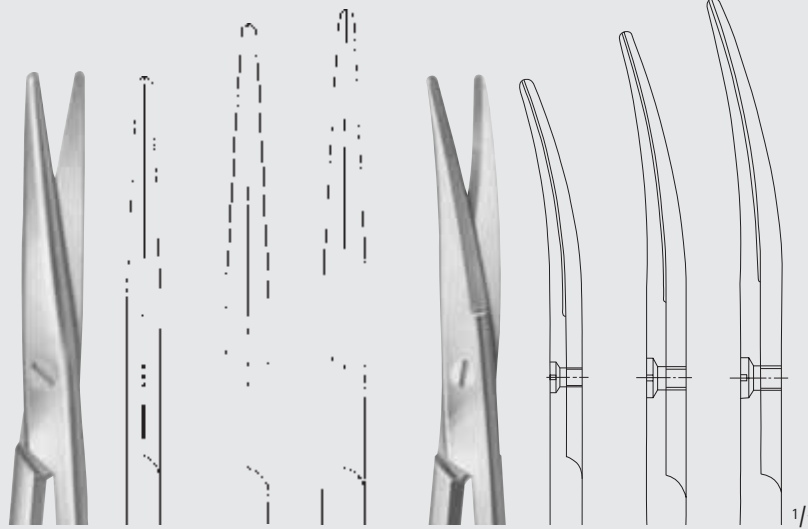

BC270R	BC274R	BC276R
180 mm	200 mm	230 mm
7"	8"	9"

BC271R	BC275R	BC277R
180 mm	200 mm	230 mm
7"	8"	9"



**NELSON-METZENBAUM**

**BC279R-BC285R**

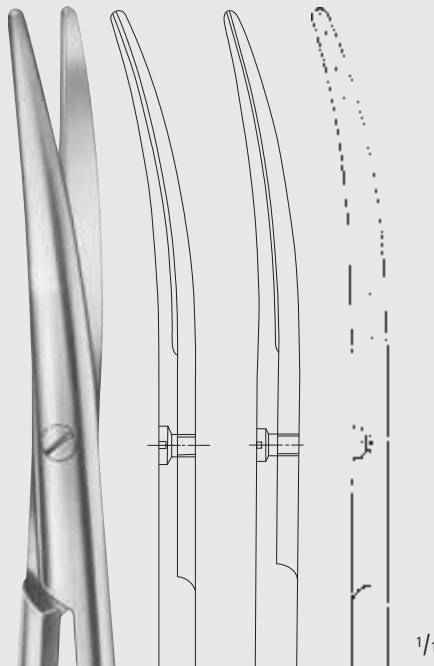

BC279R	BC281R	BC282R
260 mm	280 mm	285 mm
10 1/4"	11"	11 1/4"

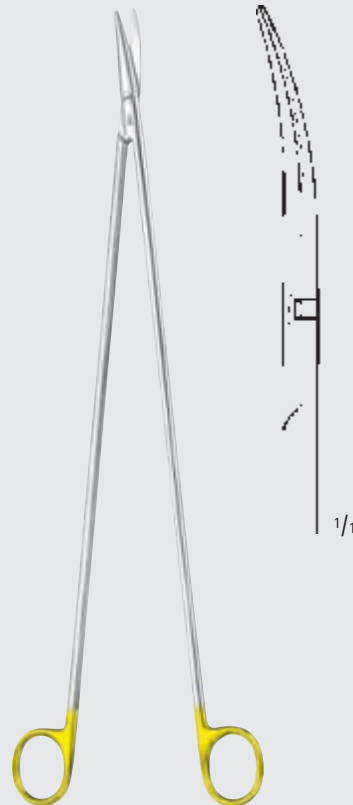

**NELSON-METZENBAUM**

**BC285R**

350 mm, 14"



MILLIMETERS

## Scheren – Scissors

DUROTIP® Präparierscheren

DUROTIP® Dissecting Scissors

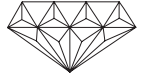

BC

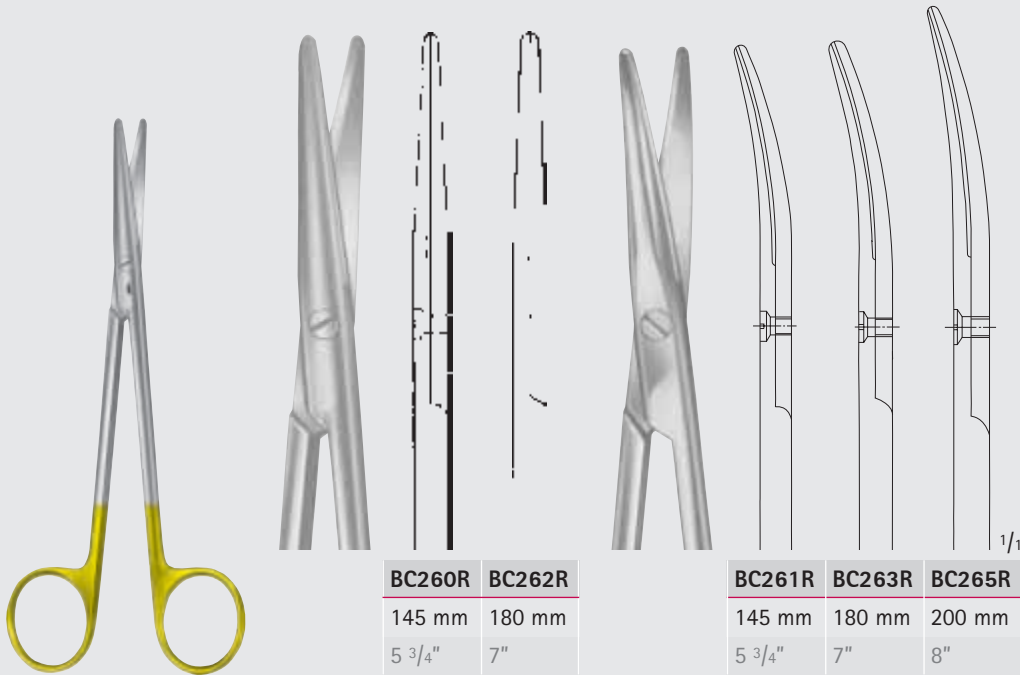

BC260R	BC262R
145 mm	180 mm
5 3/4"	7"

BC261R	BC263R	BC265R
145 mm	180 mm	200 mm
5 3/4"	7"	8"

METZENBAUM

BC260R-BC265R

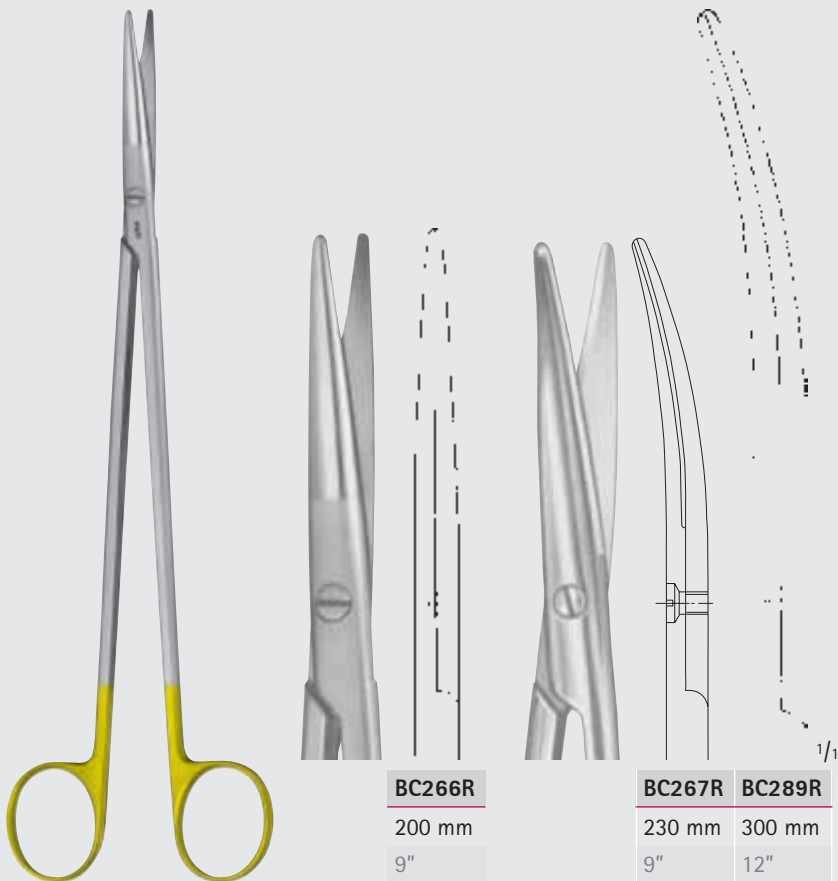

BC266R
200 mm
9"

BC267R	BC289R
230 mm	300 mm
9"	12"

NELSON-METZENBAUM (MC INDOE)

BC266R-BC289R

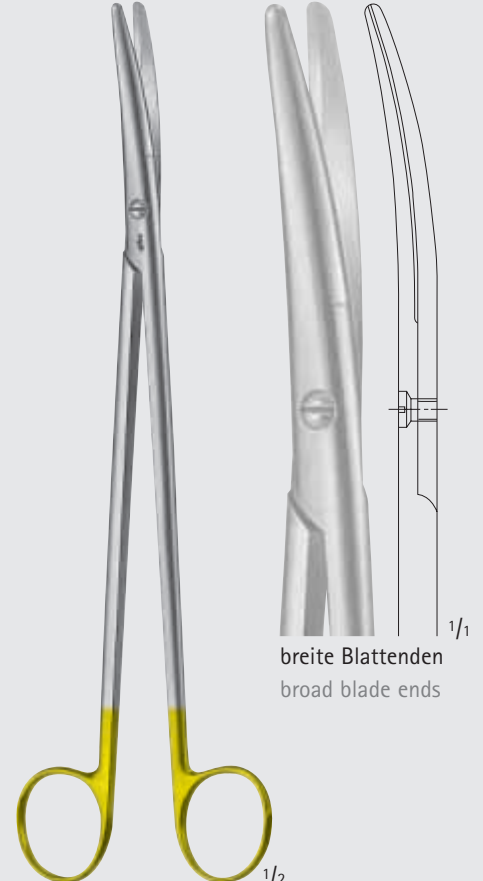

breite Blattenden  
broad blade ends

METZENBAUM

BC287R

230 mm, 9"

INCHES

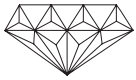

**Scheren – Scissors**  
 DUROTIP® Scheren  
 DUROTIP® Scissors

**BC**

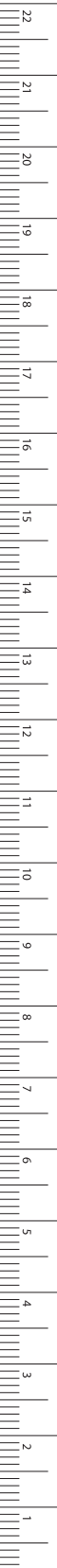

MILLIMETERS

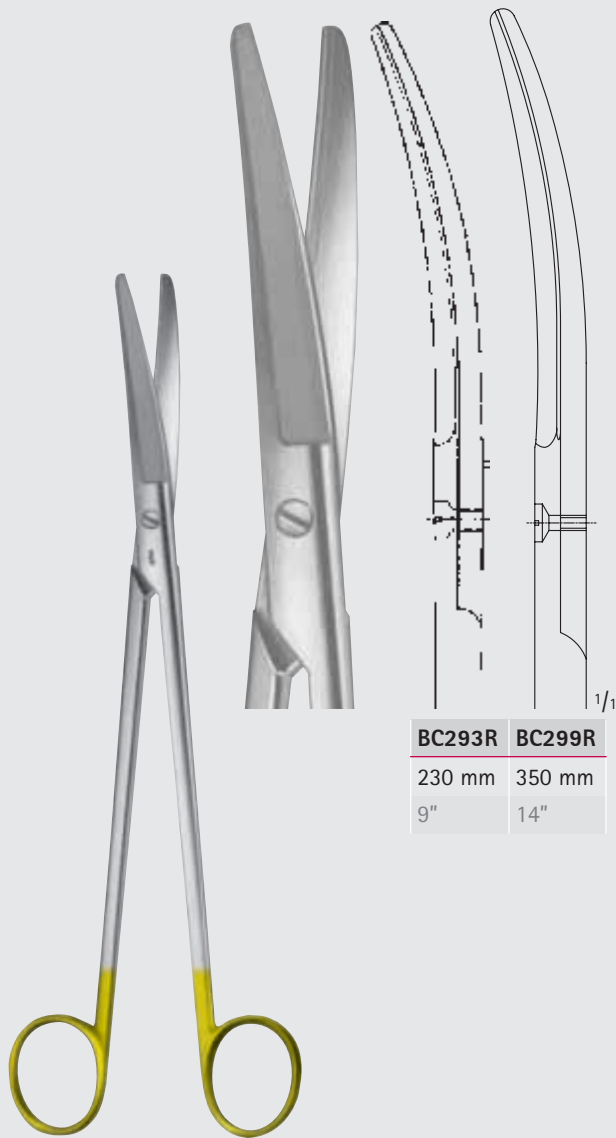

BC293R	BC299R
230 mm	350 mm
9"	14"

WERTHEIM

**BC293R-BC299R**

Präparierscheren  
 Dissecting scissors

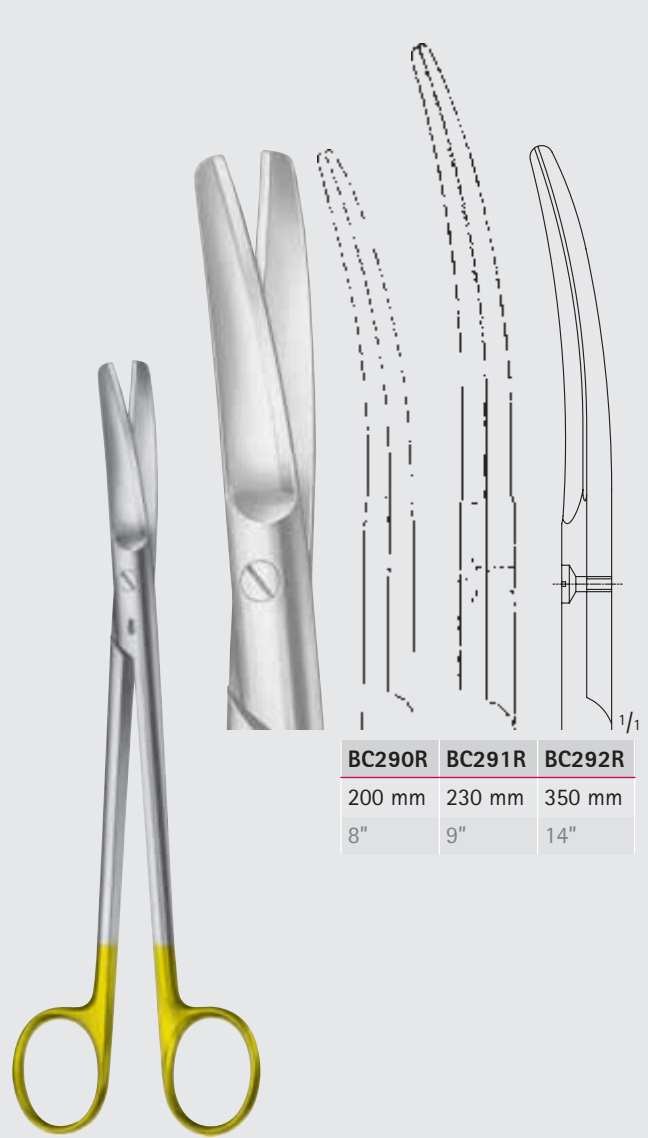

BC290R	BC291R	BC292R
200 mm	230 mm	350 mm
8"	9"	14"

SIMS

**BC290R-BC292R**

Uterusscheren  
 Uterine scissors

**Scheren – Scissors**  
 DUROTIP® Scheren  
 DUROTIP® Scissors

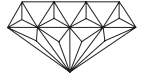

**BC**

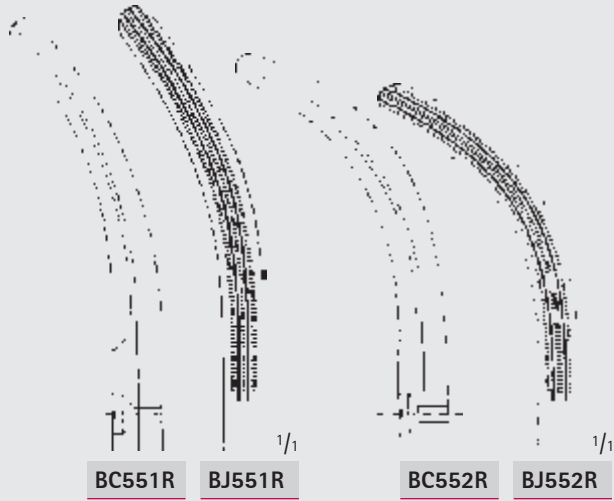

**BC551R**

**BJ551R**

**BC552R**

**BJ552R**



**BC551R**

255 mm  
10"

**BC552R**

250 mm  
10"

**BC551R-BJ552R**

Hysterektomiescheren, stark gebogen, passend zu den Parametriumklammern BJ551R und BJ552R.  
 Hysterectomy scissors, strongly curved, fitting parametrium clamps BJ551R and BJ552R.

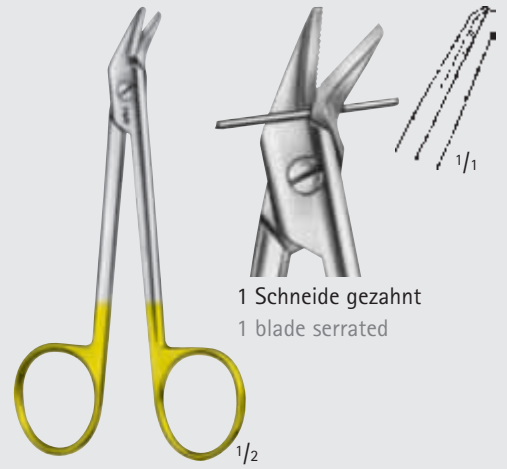

1 Schneide gezahnt  
1 blade serrated

**DP552R**

Draht- und Bleischere  
Wire cutting scissors  
120 mm, 4 3/4"

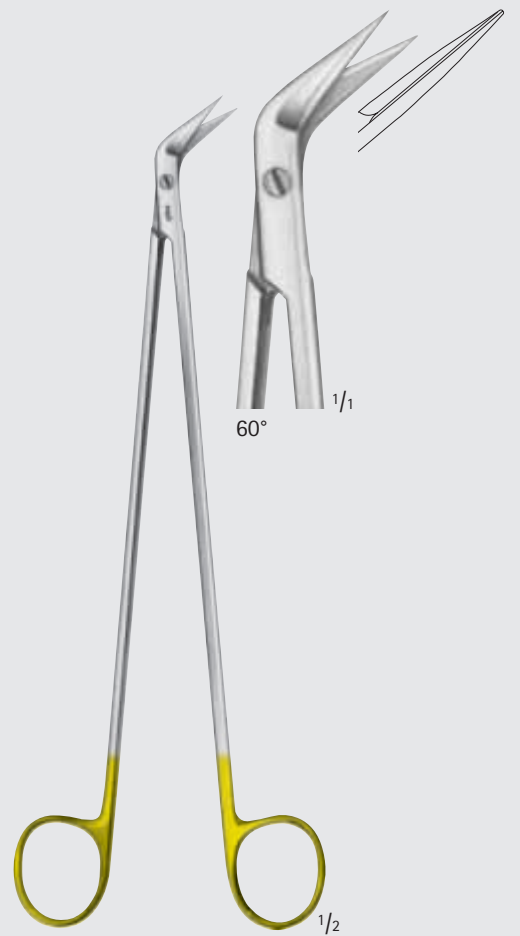

60°

**DE BAKEY**

**BC245R**

Gefäßschere  
Vascular scissors  
220 mm, 8 3/4"



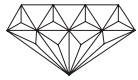

## Scheren – Scissors

DUROTIP® Scheren mit **W**ellenschliff  
DUROTIP® **W**avecut Scissors

**W**ellenschliff  
verhindert das Herausgleiten  
des Gewebes

**W**avecut  
prevents tissue  
from slipping out



Artikel mit dem Zusatz **W**  
sind auf einer Schnittfläche  
mit Wellenschliff versehen  
(bei Bestellungen bitte an-  
geben - z.B. BC211W)

**W** directly after the  
catalog number indicates  
that the resp. item has one  
serrated cutting edge.  
(When ordering please  
indicate together with the  
catalog number e.g.  
BC211W)

»grazil«



**BC211W**

Fadenschere  
Ligature scissors  
110 mm, 4 3/8"

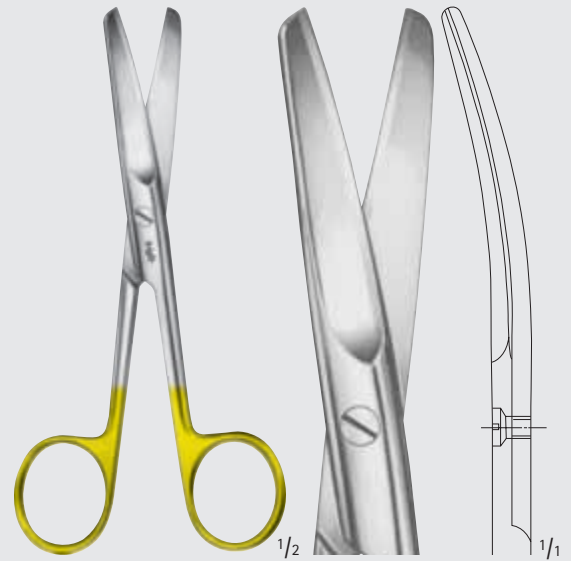

**BC231W**

Chirurgische Schere  
Surgical Scissors  
145 mm, 5 3/4"

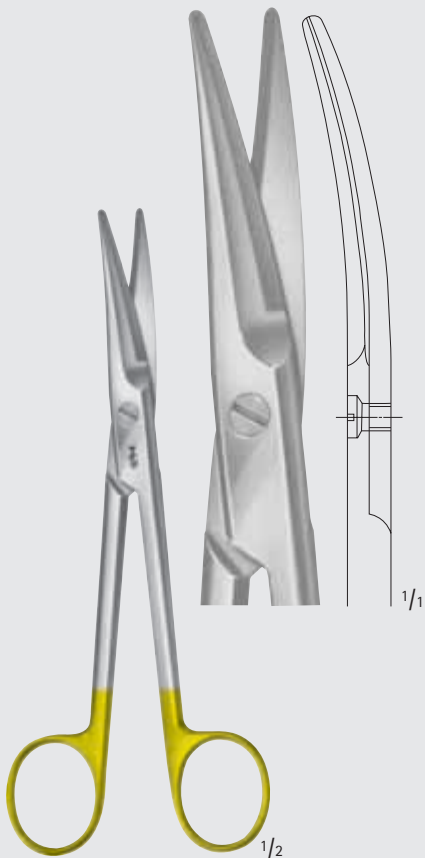

MAYO

**BC253W**

Präparierschere  
Dissecting scissors  
170 mm, 6 3/4"

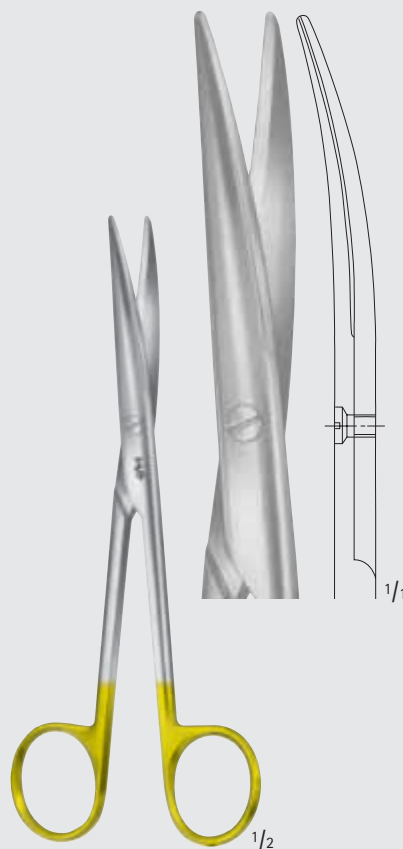

LEXER

**BC283W**

Präparierschere, schmal  
Dissecting scissors, slender  
165 mm, 6 1/2"

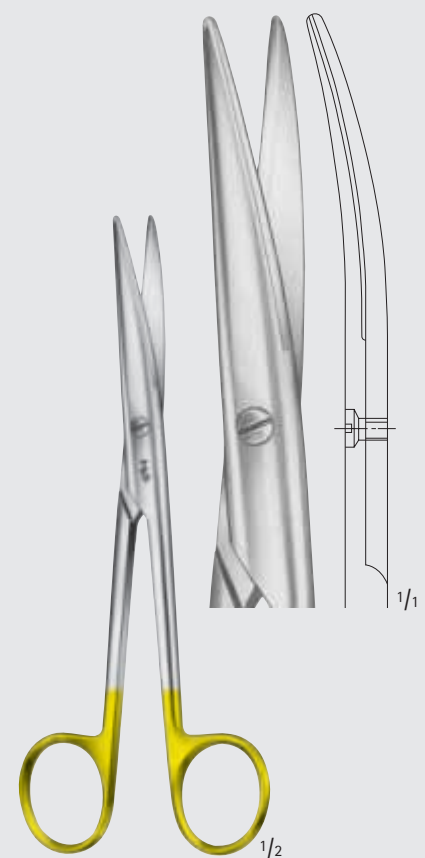

MAYO-LEXER

**BC284W**

Präparierschere  
Dissecting scissors  
165 mm, 6 1/2"

BC

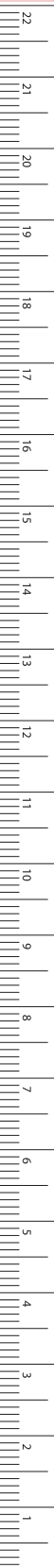

MILLIMETERS

## Scheren – Scissors

DUROTIP® Präparierscheren mit **W**ellenschliff  
 DUROTIP® **W**avecut Dissecting Scissors

»grazil«

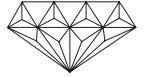

BC

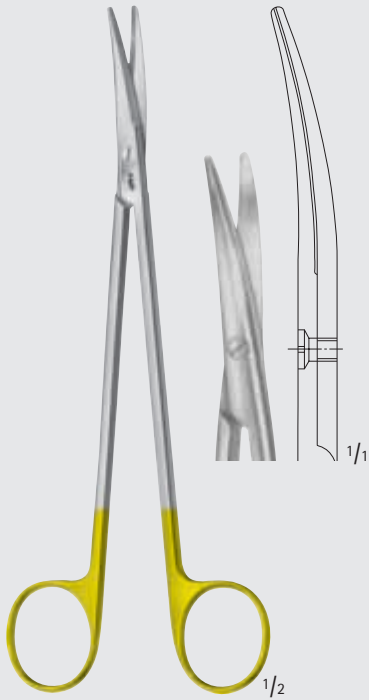

**BC257W**  
 115 mm, 4 1/2"

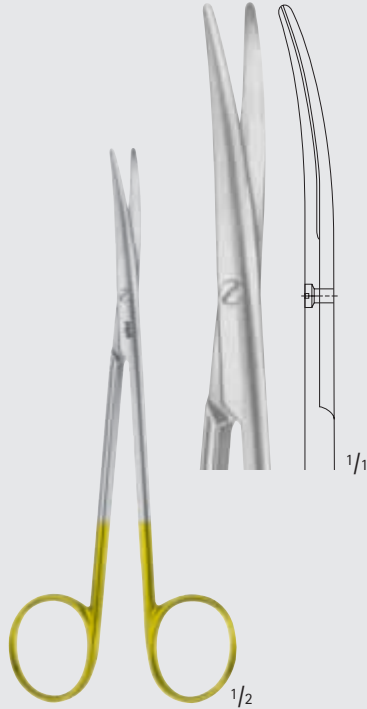

**BABY-METZENBAUM**  
**BC259W**  
 145 mm, 5 3/4"

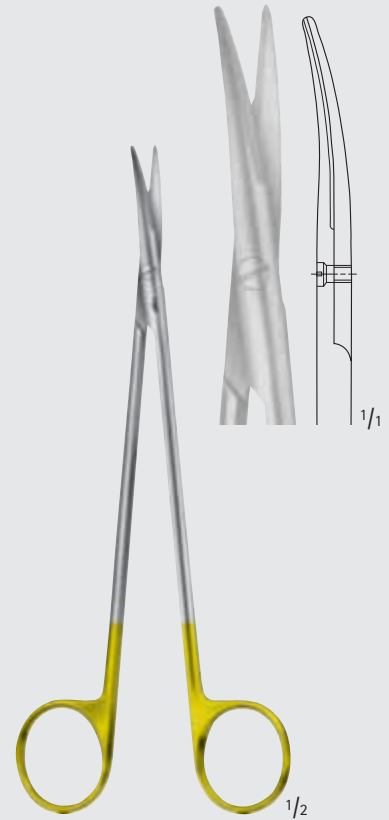

**TÖNNIS-ADSON**  
**BC273W**  
 175 mm, 7"



**METZENBAUM**  
**BC271W-BC277W**

<b>BC271W</b>	<b>BC275W</b>	<b>BC277W</b>
180 mm	200 mm	230 mm
7"	8"	9"

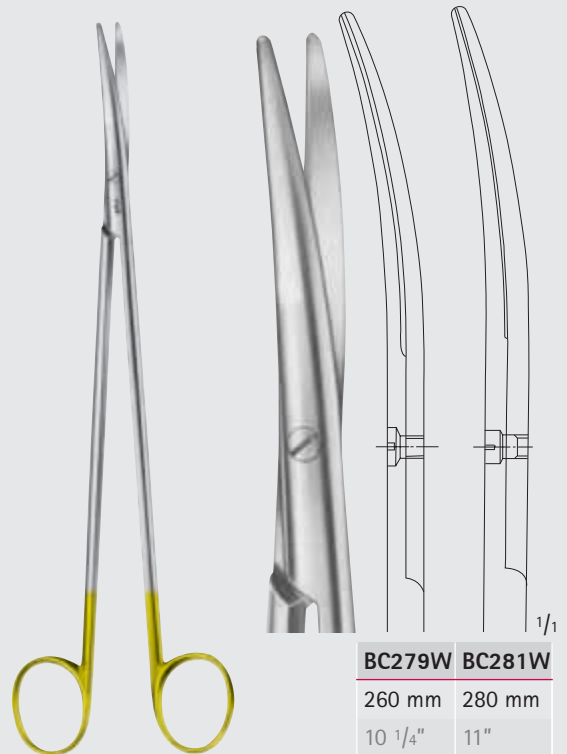

**NELSON-METZENBAUM**  
**BC279W-BC281W**

<b>BC279W</b>	<b>BC281W</b>
260 mm	280 mm
10 1/4"	11"



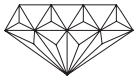

## Scheren – Scissors

DUROTIP® Präparierscheren mit Wellenschliff  
DUROTIP® Wavecut Dissecting Scissors

BC

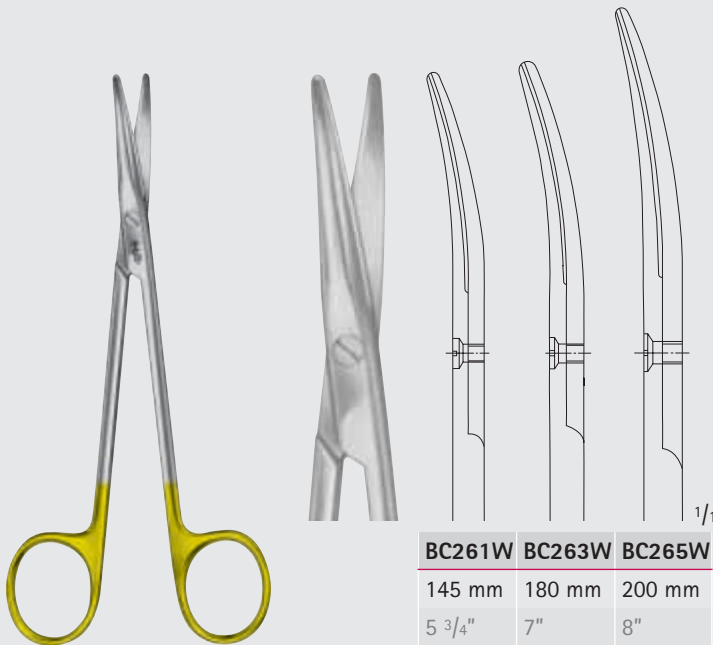

BC261W	BC263W	BC265W
145 mm	180 mm	200 mm
5 3/4"	7"	8"

METZENBAUM

BC261W-BC265W

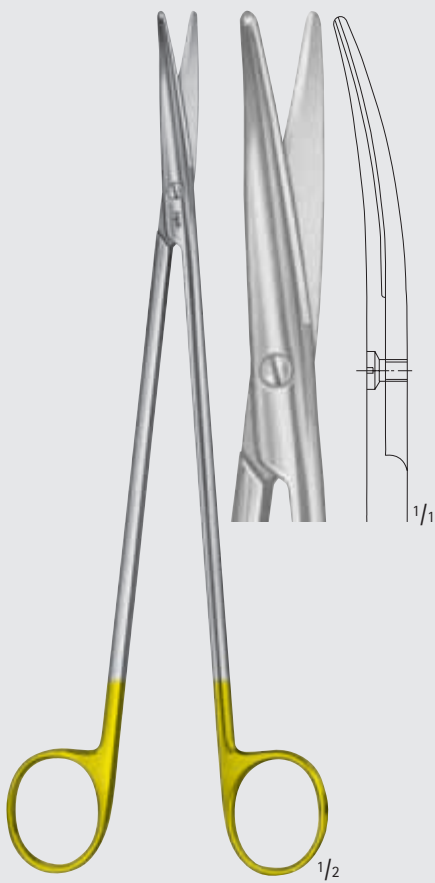

NELSON-METZENBAUM

BC267W

230 mm, 9"

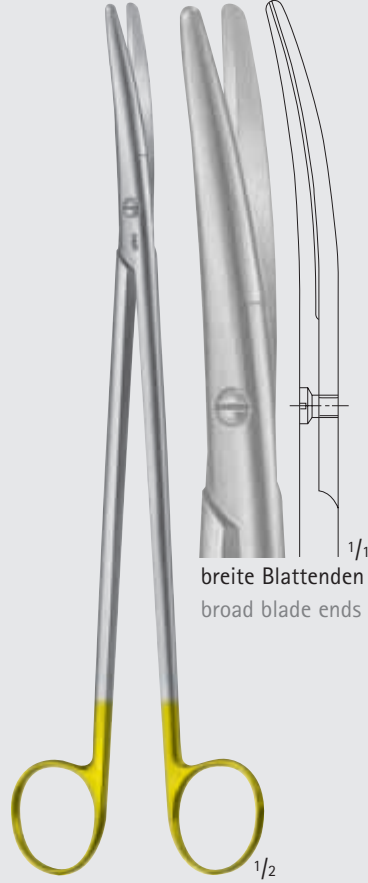

breite Blattenden  
broad blade ends

METZENBAUM

BC287W

230 mm, 9"

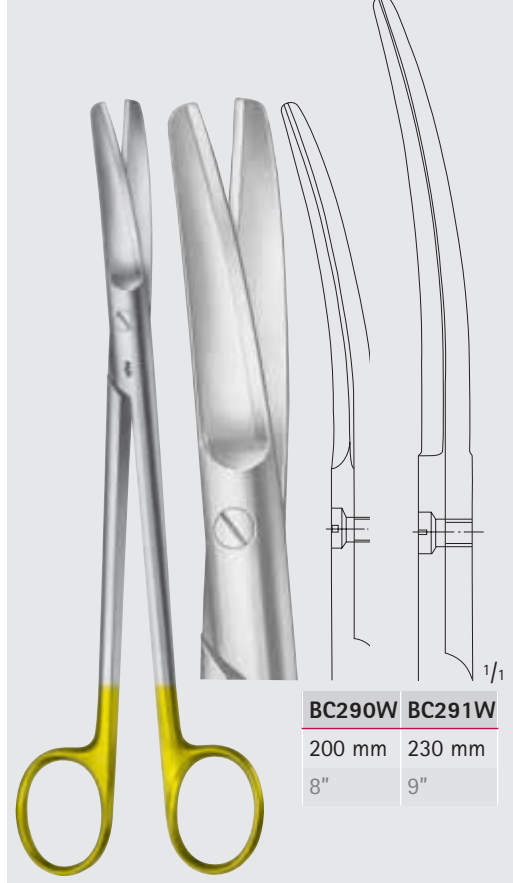

BC290W	BC291W
200 mm	230 mm
8"	9"

SIMS

BC290W-BC291W

Uterusscheren  
Uterine scissors



MILLIMETERS

## Scheren – Scissors

DUROTIP® Ligaturscheren mit Wellenschliff

DUROTIP® Wavecut Ligature Scissors

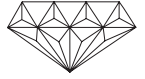

BC

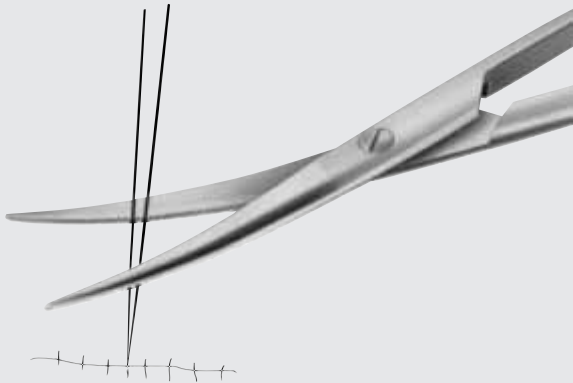

speziell zum Schneiden von Nahtmaterial

- Hartmetalleinlagen gewähren dauerhafte Schnittschärfe (auch im distalen Bereich der Scherenblätter)
- der Spezial-Wellenschliff verhindert das Abgleiten des Nahtmaterials
- DUROTIP®-Ligaturscheren sind gekennzeichnet mit 1 vergoldeten Ring

especially for cutting suture materials

- Carbide inserts guarantee permanent cutting edge (also in the distal area of the blades)
- Wavecut prevents suture materials from slipping out
- DUROTIP® ligature scissors are identified by 1 goldplated ring



BC294W-BC298W

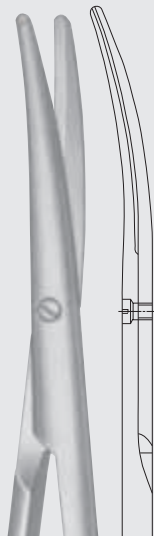

BC294W

145 mm

5 3/4"

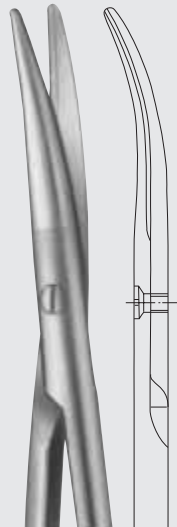

BC295W

180 mm

7"

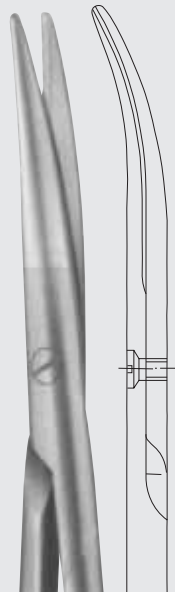

BC296W

230 mm

9"

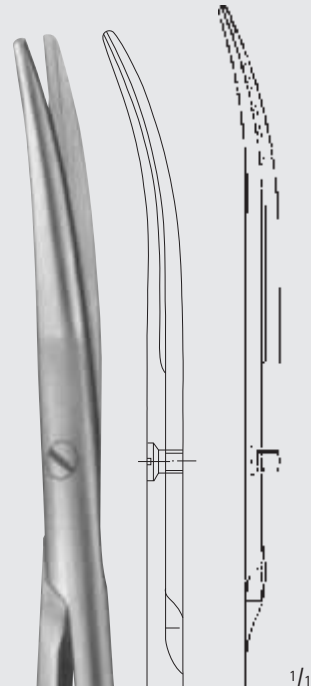

BC297W

260 mm

10 1/4"

BC298W

350 mm

14"

1/1





**Scheren – Scissors**  
**Präparierscheren Noir**  
**Dissecting Scissors Noir**

**BC**

»grazil«

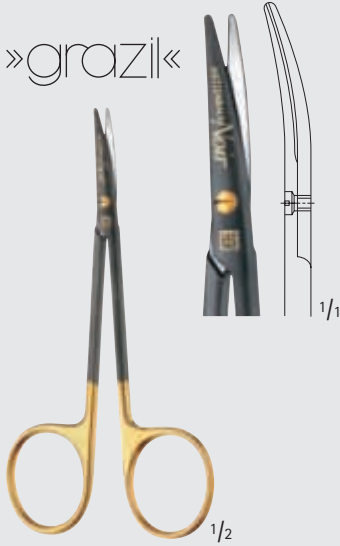

**BC257B**

115 mm, 4 1/2"

»grazil«



**BABY-METZENBAUM**

**BC259B**

145 mm, 5 3/4"

»grazil«

»grazil«



<b>BC261B</b>	<b>BC263B</b>	<b>BC265B</b>
145 mm	180 mm	200 mm
5 3/4"	7"	8"

<b>BC271B</b>	<b>BC275B</b>
180 mm	200 mm
7"	8"

**METZENBAUM**

**BC261B-BC275B**

»grazil«



**BC283B BC284B**

**MAYO-LEXER**

**BC283B-BC284B**

165 mm, 6 1/2"



MILLIMETERS

## Scheren – Scissors

Präparierscheren Noir mit Wellenschliff

Wavecut Dissecting Scissors Noir



Wellenschliff verhindert das Herausgleiten des Gewebes während des Schneidens

Wavecut prevents tissue from slipping out during the cutting process



**BC257WB**

115 mm, 4 1/2"



**BABY-METZENBAUM**

**BC259WB**

145 mm, 5 3/4"

BC





## Scheren – Scissors

Präparierscheren Noir mit Wellenschliff  
Wavecut Dissecting Scissors Noir



METZENBAUM

**BC261WB-BC275WB**

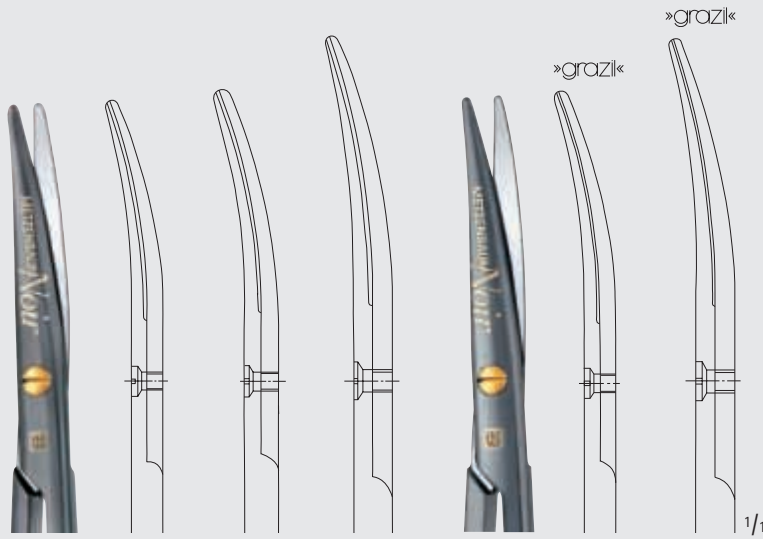

BC261WB	BC263WB	BC265WB
145 mm	180 mm	200 mm
5 3/4"	7"	8"

BC271WB	BC275WB
180 mm	200 mm
7"	8"



MAYO-LEXER

**BC283WB-BC284WB**

165 mm, 6 1/2"



**BC283WB BC284WB**

BC

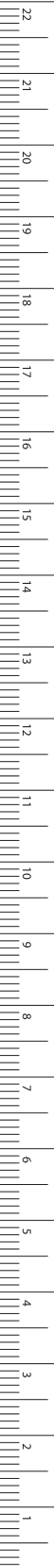

MILLIMETERS

**Scheren – Scissors**

Mikro-Gefäßscheren

Micro Vascular Scissors

BC

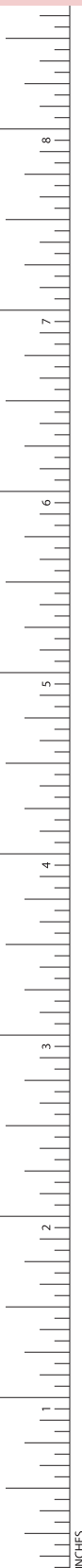

1/1

DIETHRICH-POTTS  
180 mm, 7"





## Scheren – Scissors

Mikro-Gefäßscheren  
Micro Vascular Scissors

BC

25°



BC522R

45°

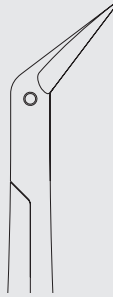

BC523R

60°

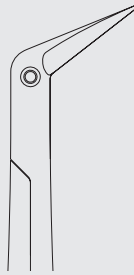

BC524R

90°

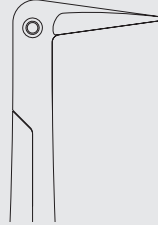

BC525R

125°

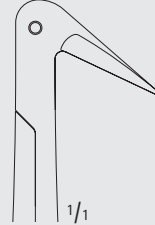

BC526R

Standard Blatt  
Standard blade



BC531R



BC532R

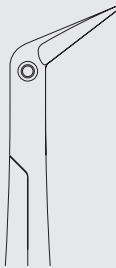

BC533R



BC534R

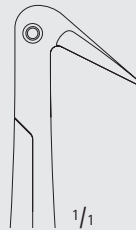

BC535R

Sehr feines Blatt  
Delicate blade



BC515R



BC516R



BC517R



BC518R



BC519R

Extrem feines Blatt  
Ultra delicate blade

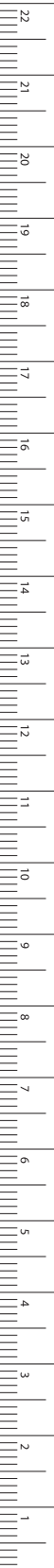

MILLIMETERS

**Scheren – Scissors**  
 Gefäßscheren  
 Cardiovascular Scissors

BC

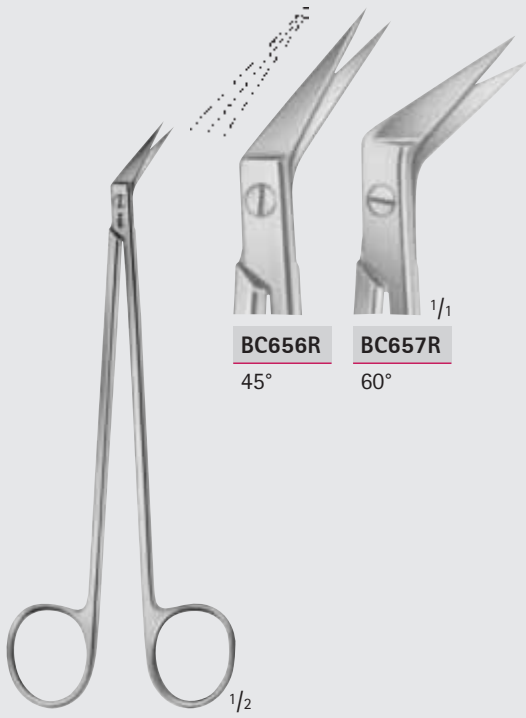

DE BAKEY

**BC656R-BC657R**

155 mm, 6"

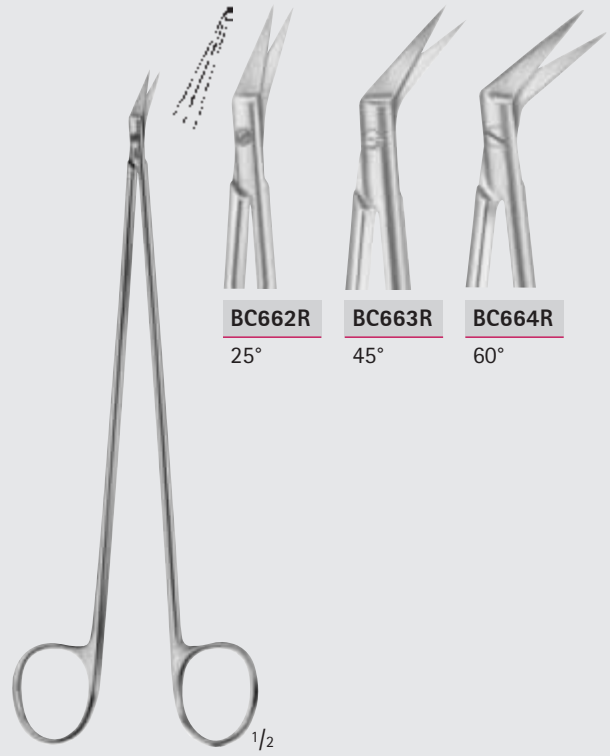

DIETRICH-HEGEMANN

**BC662R-BC664R**

180 mm, 7"

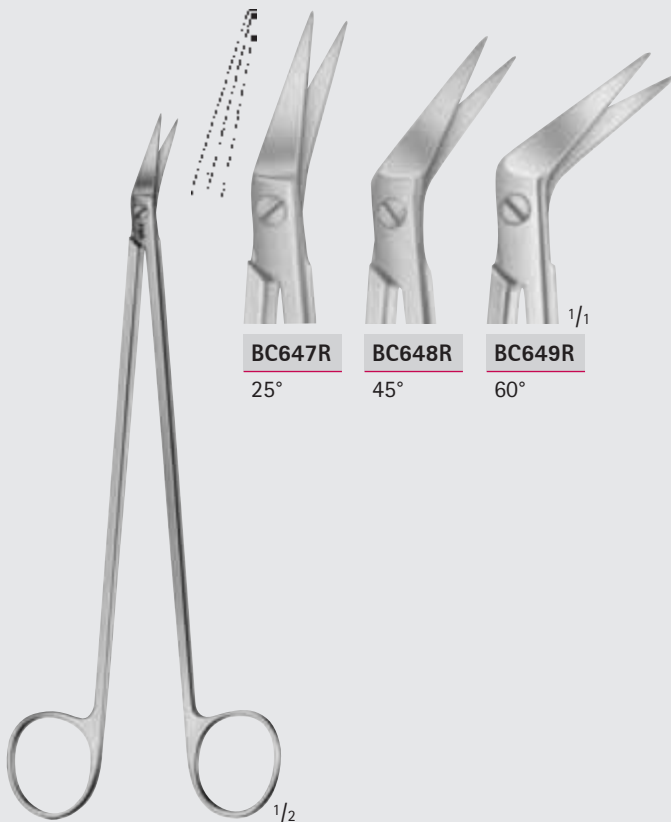

POTTS-DE MARTEL

**BC647R-BC649R**

185 mm, 7 1/4"

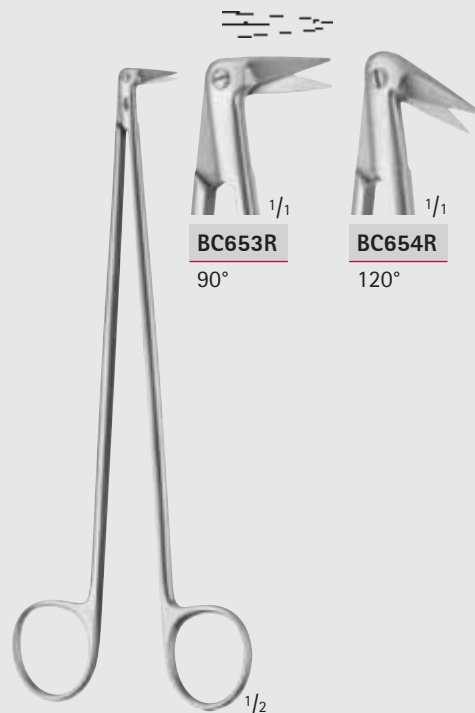

DIETRICH

**BC653R-BC654R**

170 mm, 6 3/4"



**Scheren – Scissors**  
 Gefäßscheren  
 Cardiovascular Scissors

**BC**

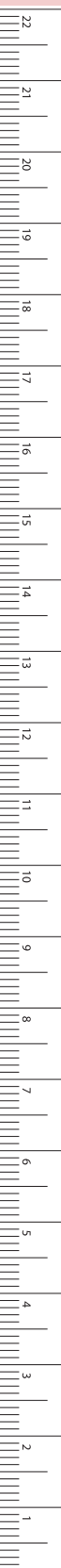

MILLIMETERS

**POTTS-SMITH**  
**BC646R**  
 Gefäßschere  
 Cardiovascular scissors  
 180 mm, 7"

**POTTS-SMITH**  
**BC652R**  
 Gefäßschere  
 Cardiovascular scissors  
 180 mm, 7"

**POTTS-DE MARTEL**  
**BC650R**  
 60°

**MILLS**  
**BC651R**  
 60°

**BC650R-BC651R**  
 Gefäßscheren  
 Cardiovascular scissors  
 220 mm, 8 3/4"

**DE BAKEY**  
**BC669R**  
 Offset-Schere, S-förmig  
 Offset scissors, s-shaped  
 155 mm, 6"

**FAVOLORO**  
**BC670R**  
 Gefäßschere  
 Cardiovascular scissors  
 140 mm, 5 1/2"

## Scheren – Scissors

Scheren für Gefäß- und Neurochirurgie  
Scissors for Vascular and Neuro Surgery

BC

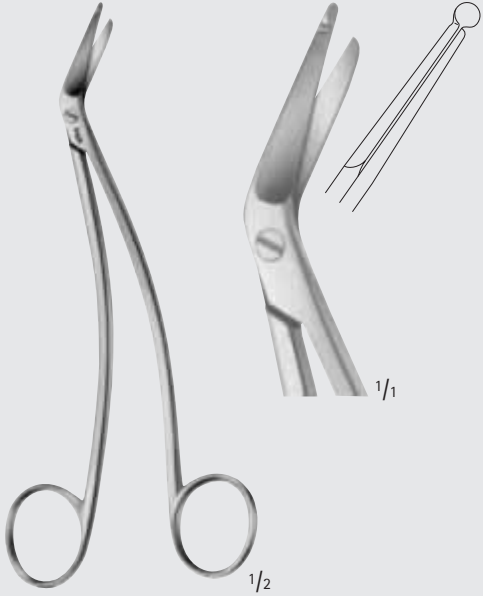

SCHMIEDEN-TAYLOR

**BC660R**

Duraschere

Dura scissors

155 mm, 6"

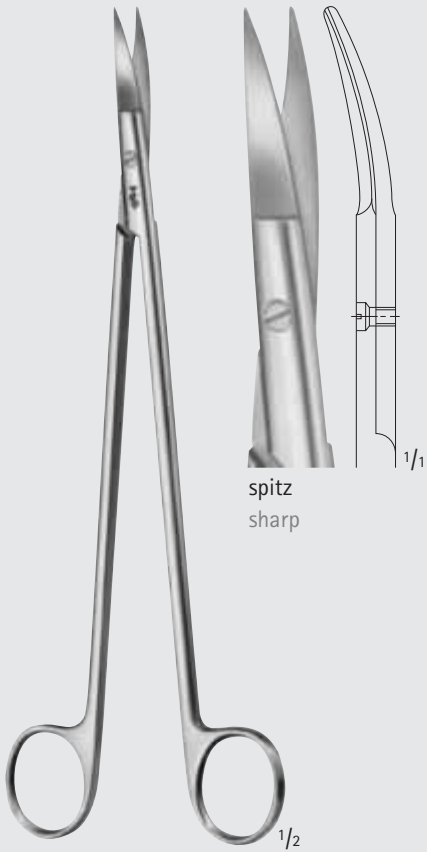

STRULLY

**BC644R**

Gefäßschere

Vascular scissors

220 mm, 8 3/4"

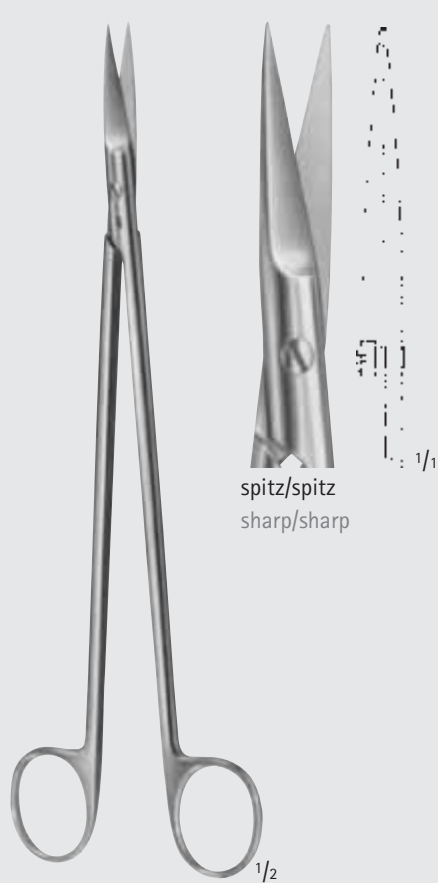

**BC642R**

Gefäßschere

Vascular scissors

225 mm, 9"



## Scheren – Scissors

Scheren für Gefäß- und Neurochirurgie  
Scissors for Vascular and Neuro Surgery

BC

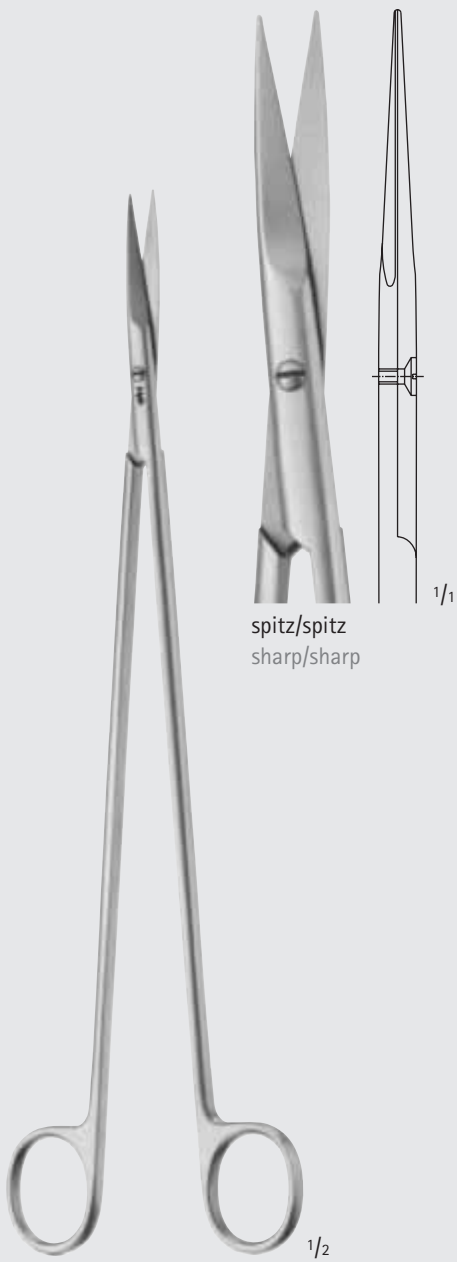

spitz/spitz  
sharp/sharp

1/1

1/2

BARRÉ

**BC715R**

280 mm, 11"

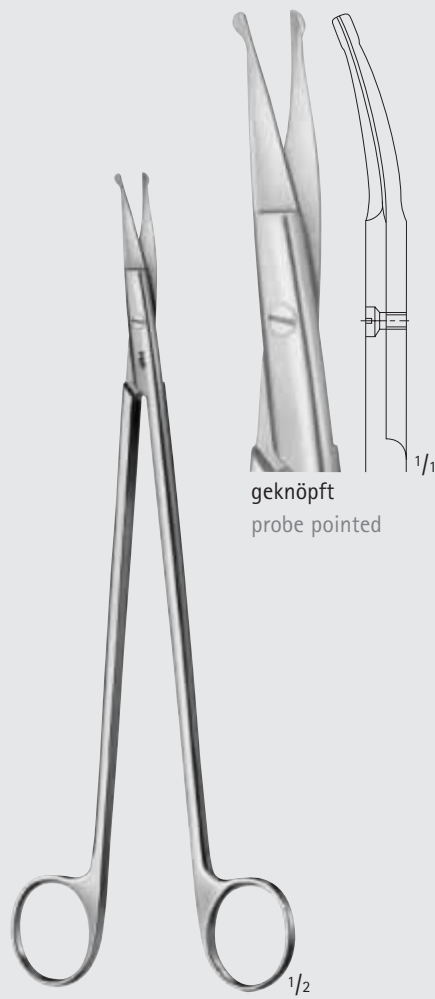

geknöpft  
probe pointed

1/1

1/2

STRULLY

**BC645R**

220 mm, 8 3/4"

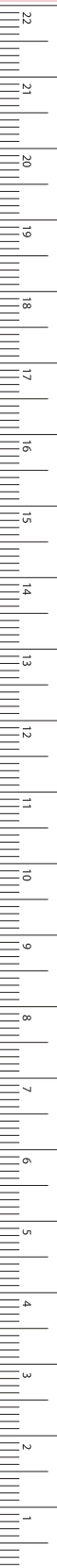

MILLIMETERS

**Scheren – Scissors**  
 Scheren für die Gefäßchirurgie  
 Scissors for Vascular Surgery

BC



BC658R	BC659R
gerade	gebogen
sehr fein	sehr fein
straight	curved
very	very
delicate	delicate

**BC658R-BC659R**  
 190 mm, 7 1/2"

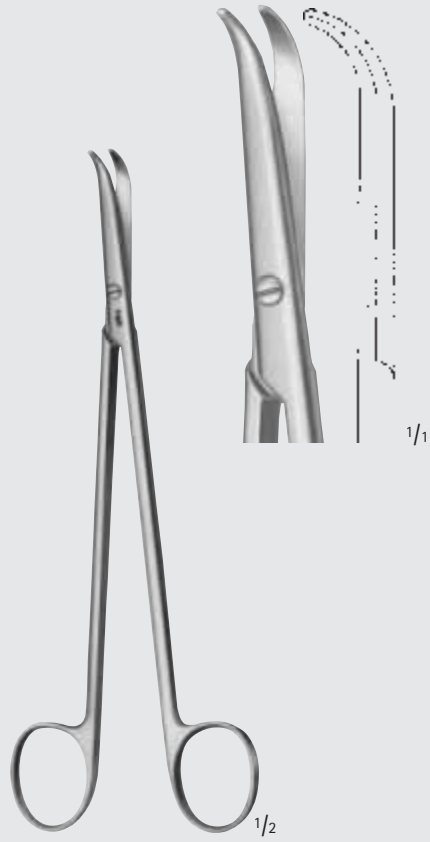

**THOREK**  
**BC636R**  
 180 mm, 7"

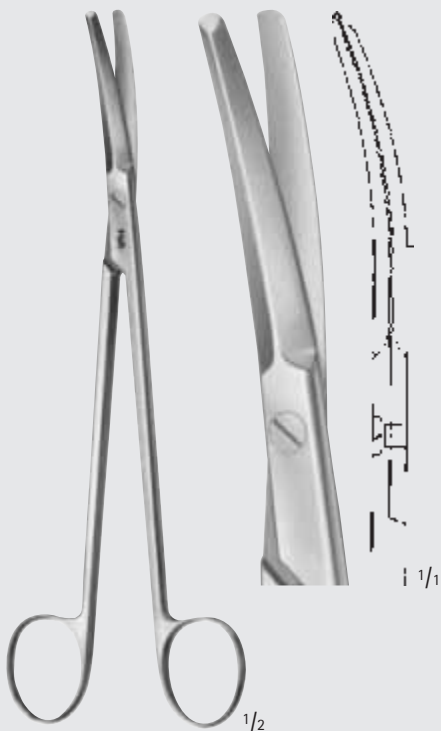

**POTTS-SMITH**  
**BC643R**  
 190 mm, 7 1/2"

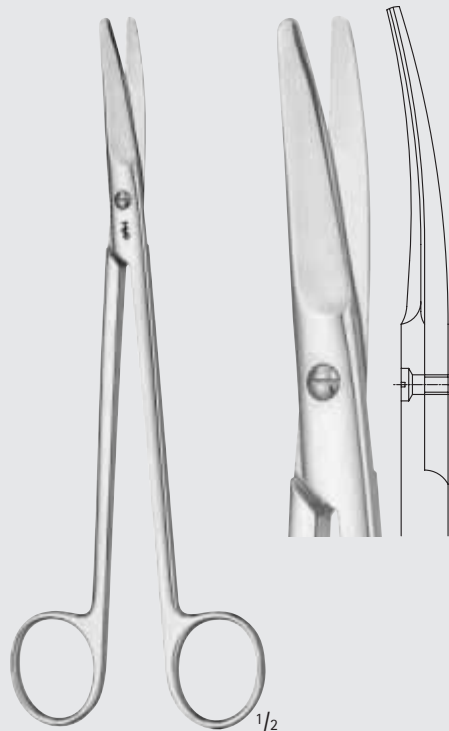

**COOLEY**  
**BC597R**  
 190 mm, 7 1/2"



**Scheren – Scissors**  
Scheren für Gefäßchirurgie  
Scissors for Vascular Surgery

**BC**

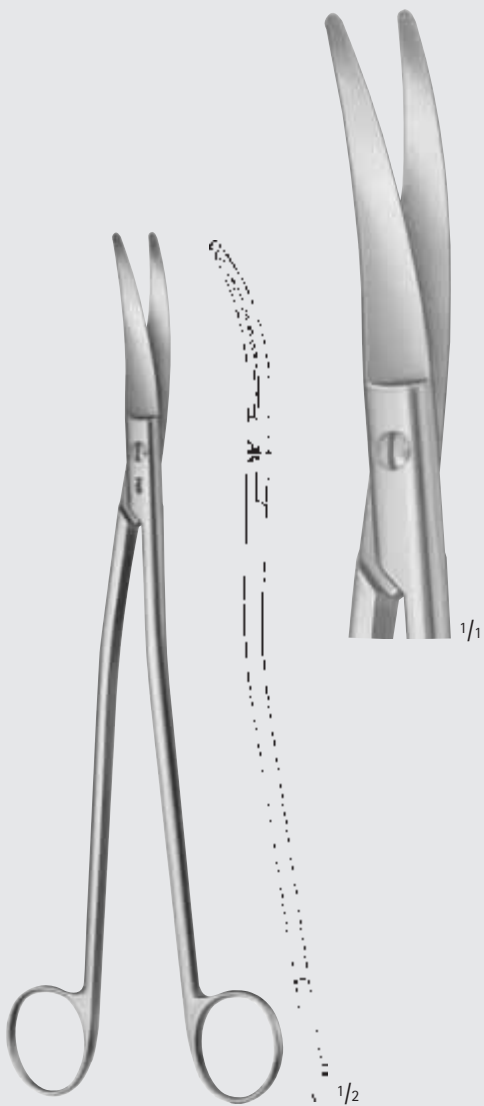

**KLINKENBERG-LOTH**

**BC640R**

230 mm, 9"

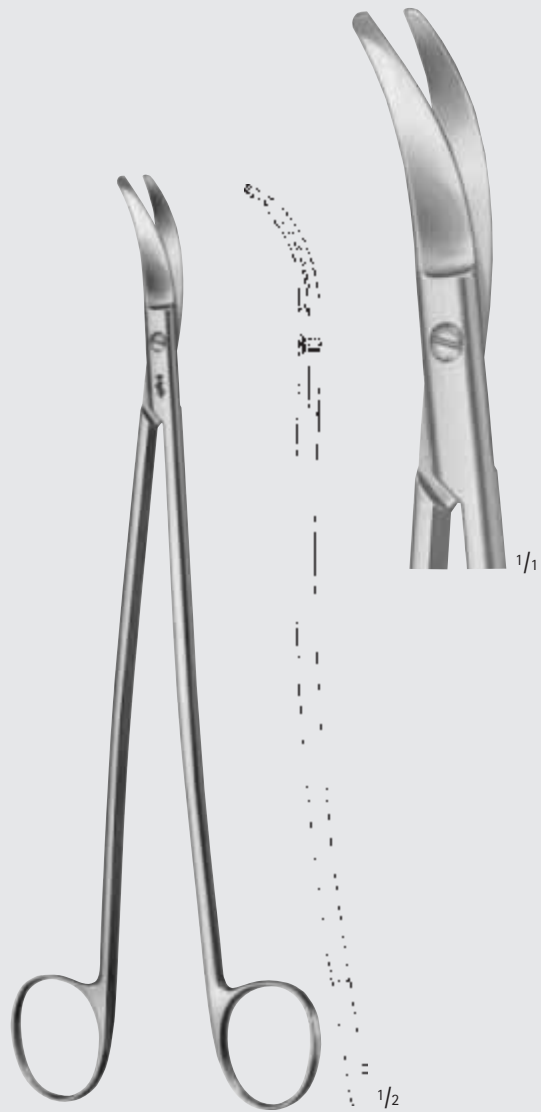

**SATINSKY**

**BC641R**

245 mm, 9 3/4"

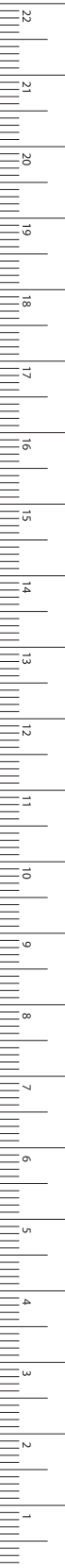

MILLIMETERS

**Scheren – Scissors**  
Knochenscheren  
Bone Shears

BC



KILLIAN

**OP130R**

200 mm, 8"



MÜHLING

**FO216R**

210 mm, 8 1/4"





## Scheren – Scissors

Scheren für Operation in der Tiefe und für Gynäkologie  
Scissors for Deep Operations and for Gynecology

BC



SIMS

BC721R-BC743R



BC721R	BC723R
200 mm	230 mm
8"	9"



BC741R	BC743R
200 mm	230 mm
8"	9"



SIMS

BC746R-BC748R



BC746R	BC748R
200 mm	230 mm
8"	9"



MILLIMETERS

## Scheren – Scissors

Scheren für Operation in der Tiefe und für Gynäkologie  
Scissors for Deep Operations and for Gynecology

BC

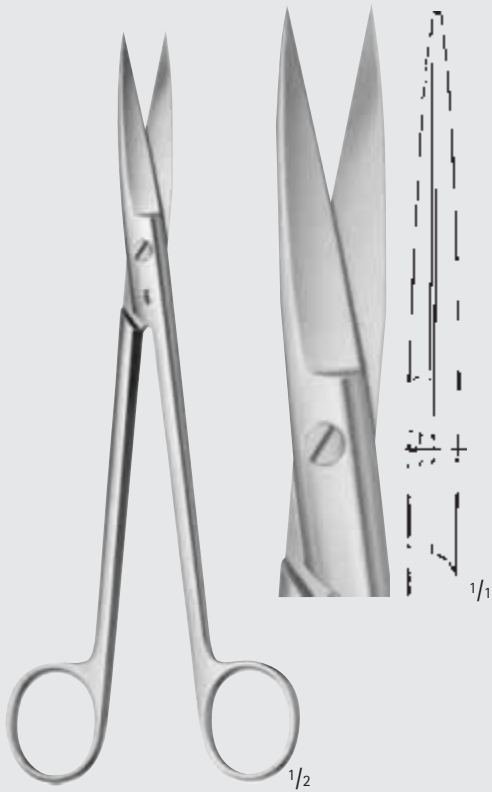

SIMS

**BC731R**

200 mm, 8"

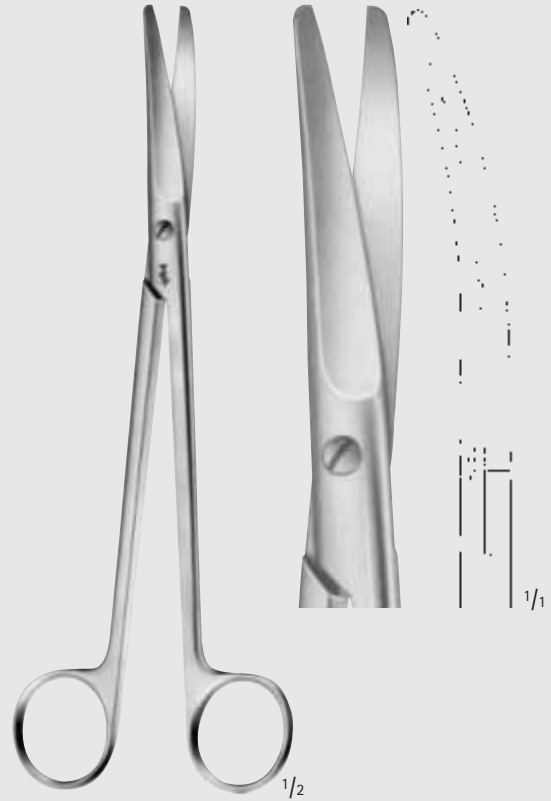

SIMS

**BC708R**

210 mm, 8 1/4"

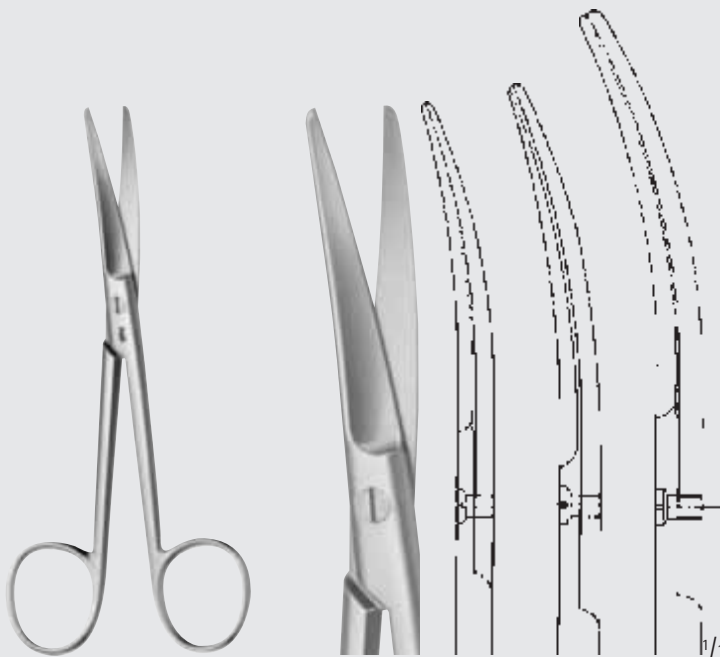

WERTHEIM

**BC702R-BC704R**

BC702R	BC703R	BC704R
145 mm	200 mm	230 mm
5 3/4"	8"	9"

## Scheren – Scissors

Scheren für Operation in der Tiefe und für Gynäkologie  
Scissors for Deep Operations and for Gynecology

BC

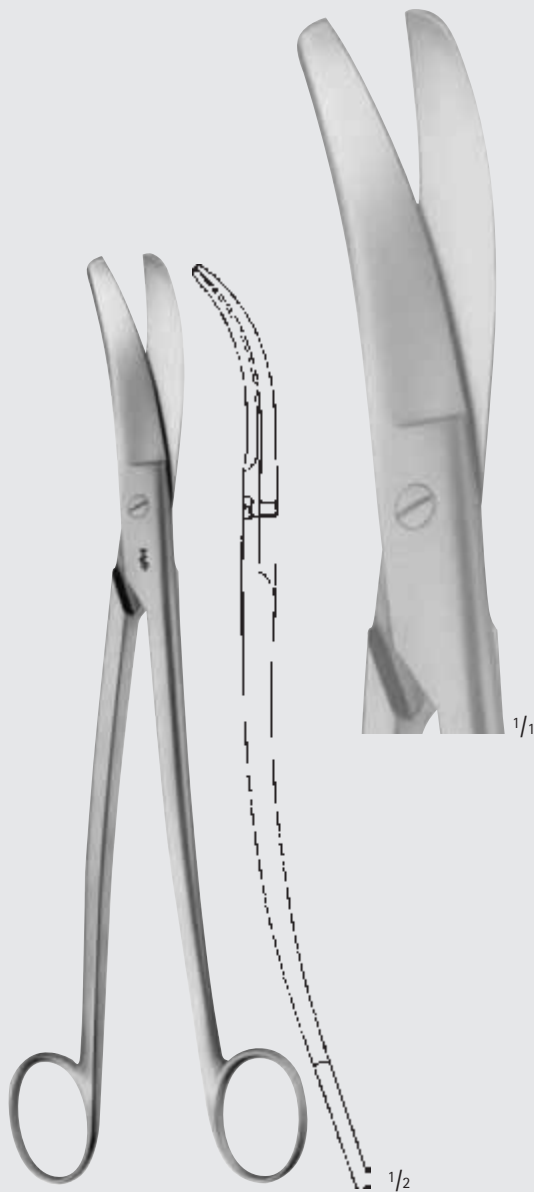

SIEBOLD

**BC760R**

Uterusschere  
Uterine scissors  
245 mm, 9 3/4"

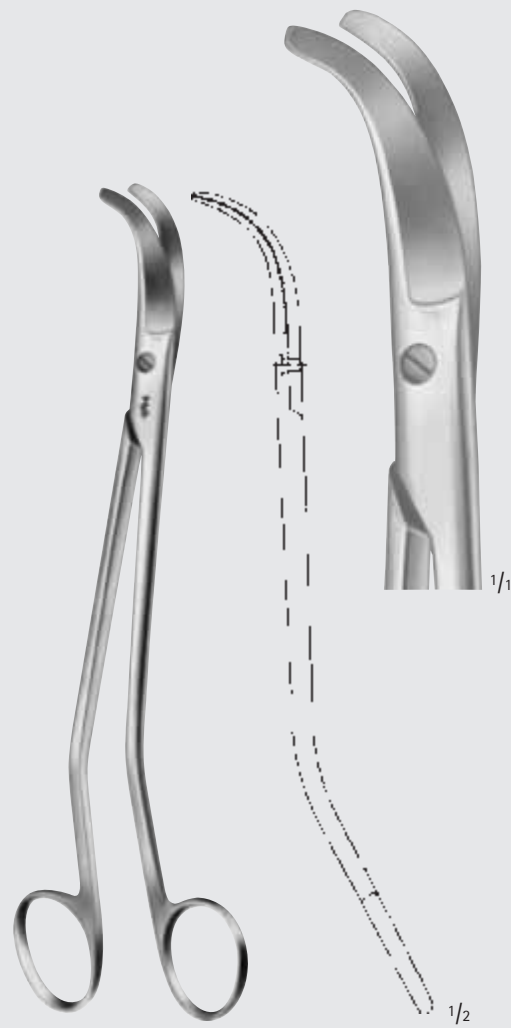

BOZEMANN

**BC761R**

Uterusschere  
Uterine scissors  
220 mm, 8 3/4"



MILLIMETERS

## Scheren – Scissors

Scheren für Operation in der Tiefe und für Gynäkologie  
Scissors for Deep Operations and for Gynecology

BC

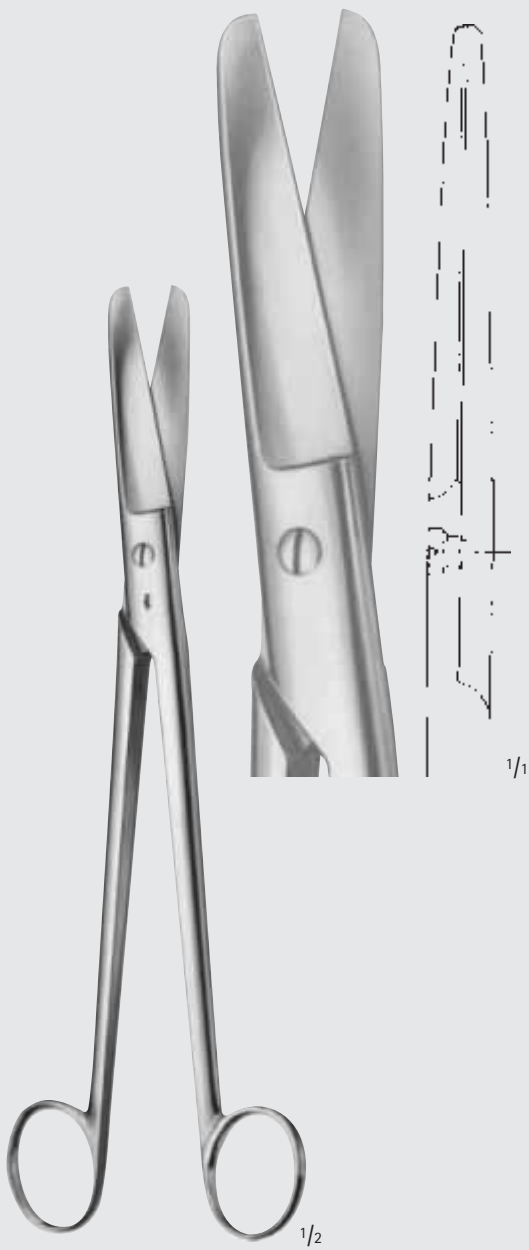

SIMS-SIEBOLD

**BC762R**

Uterusschere  
Uterine scissors  
250 mm, 10"

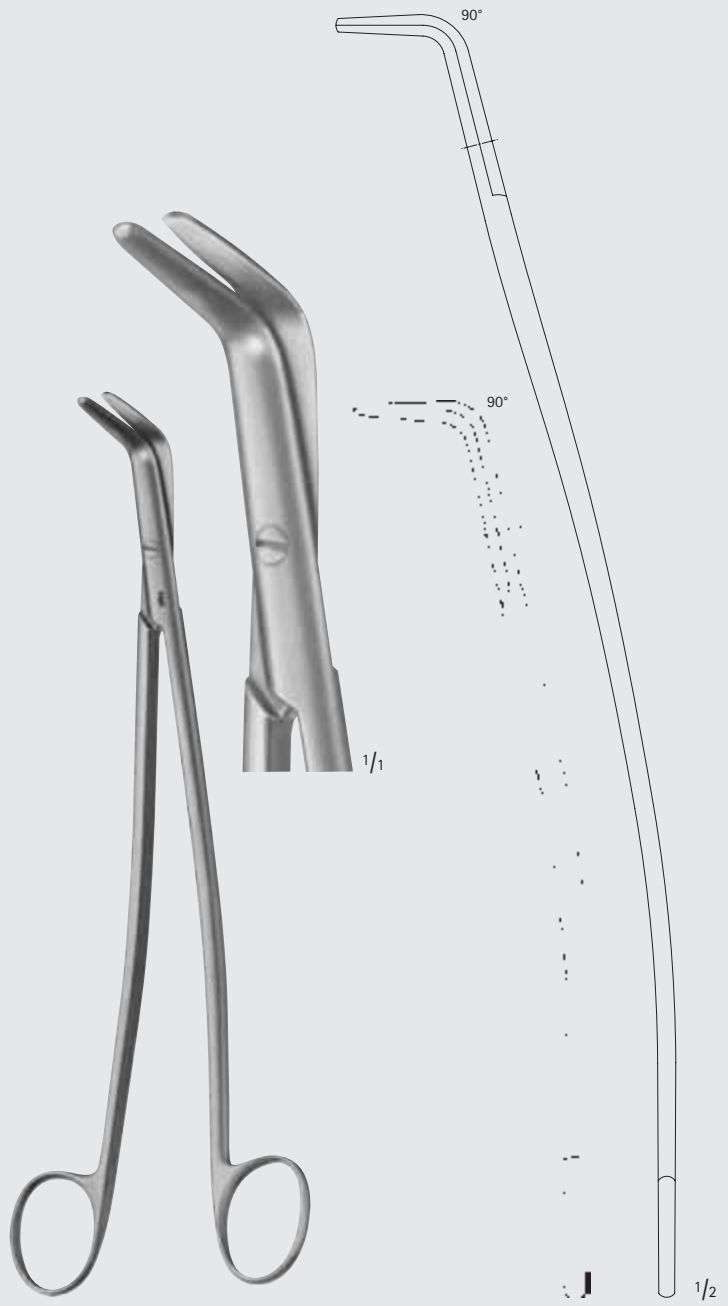

KIEBACK

**BC763R-BC765R**

Parametriumscheren  
Parametrium scissors

BC763R	BC765R
240 mm	350 mm
9 1/2"	14"



## Scheren – Scissors

Scheren für Operation in der Tiefe und für Gynäkologie  
Scissors for Deep Operations and for Gynecology

BC



BC764R	BC766R
260 mm	350 mm
10 1/4"	9 1/2"

KIEBACK

**BC764R-BC766R**

Parametriumscheren, seitwärts gebogen, 1 Blatt mit Knopfspitze  
Parametrium scissors, curved to side, with 1 probe pointed blade



MILLIMETERS

## Scheren – Scissors

Chirurgische Scheren, kräftige Modelle  
Surgical Scissors, Heavy Patterns

BC



**BC771R**

Bauchdeckenschere  
Abdominal scissors  
160 mm, 6 1/4"



**BC774R**

Bauchdeckenschere  
Abdominal scissors  
180 mm, 7"



**BC772R-BC776R**

Bauchdeckenscheren  
Abdominal scissors

<b>BC772R</b>	<b>BC776R</b>
160 mm	180 mm
6 1/4"	7"



**Scheren – Scissors**  
Scheren für Geburtshilfe  
Scissors for Obstetrics

**BC**



**SCHUHMACHER**

**ET150R**

Nabelschnurschere  
Umbilical cord scissors  
155 mm, 6"

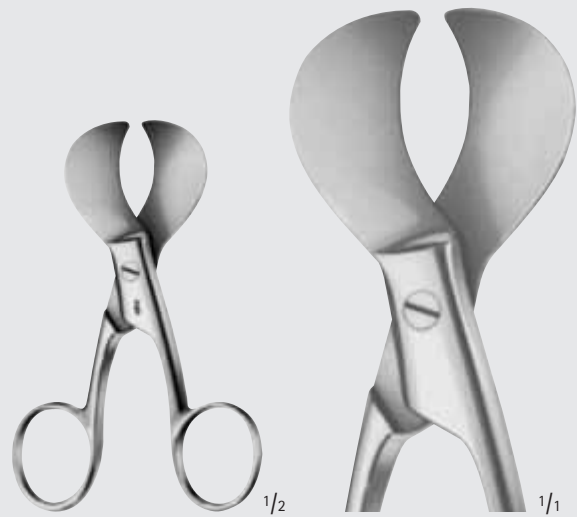

**ET152R**

Nabelschnurschere  
Umbilical cord scissors  
105 mm, 4 1/8"

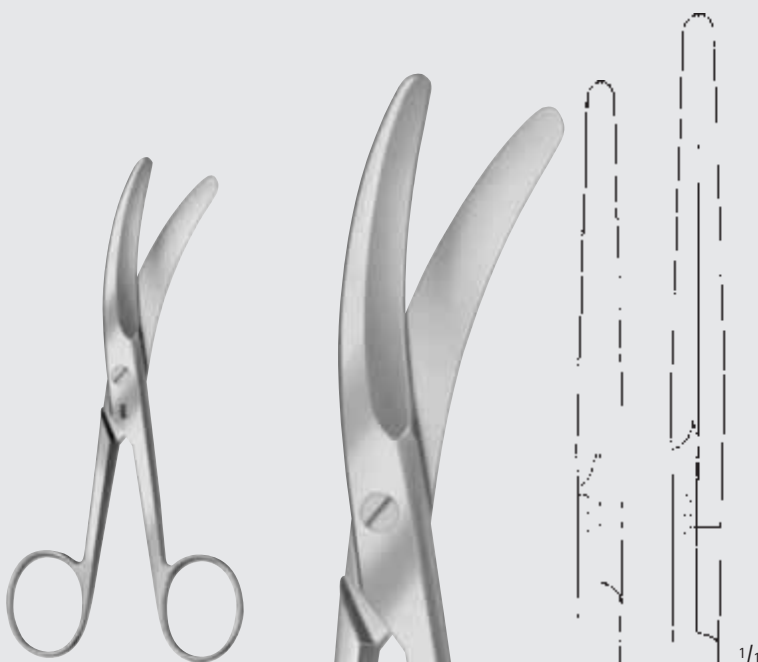

**BC796R-BC797R**

Nabelschnurscheren  
Umbilical cord scissors

<b>BC796R</b>	<b>BC797R</b>
135 mm	160 mm
5 1/4"	6 1/4"

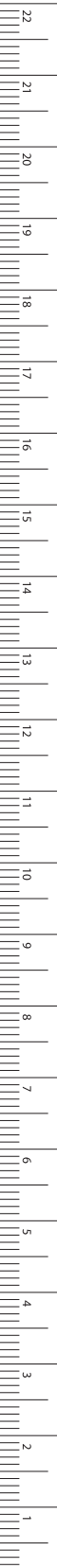

MILLIMETERS

## Scheren – Scissors

Scheren für Geburtshilfe

Scissors for Obstetrics

BC



BRAUN-STADLER

**ET140R-ET141R**

Dammscheren

Episiotomy scissors



1/1

**ET140R**

145 mm

5 3/4"



1/1

**ET141R**

200 mm

8"



1/1

**ET142R**

Dammschere

Episiotomy scissors

240 mm, 9 1/2"

1/2



**Scheren – Scissors**  
 Darmscheren, Rektumschere  
 Bowel Scissors, Rectal Scissors

**BC**

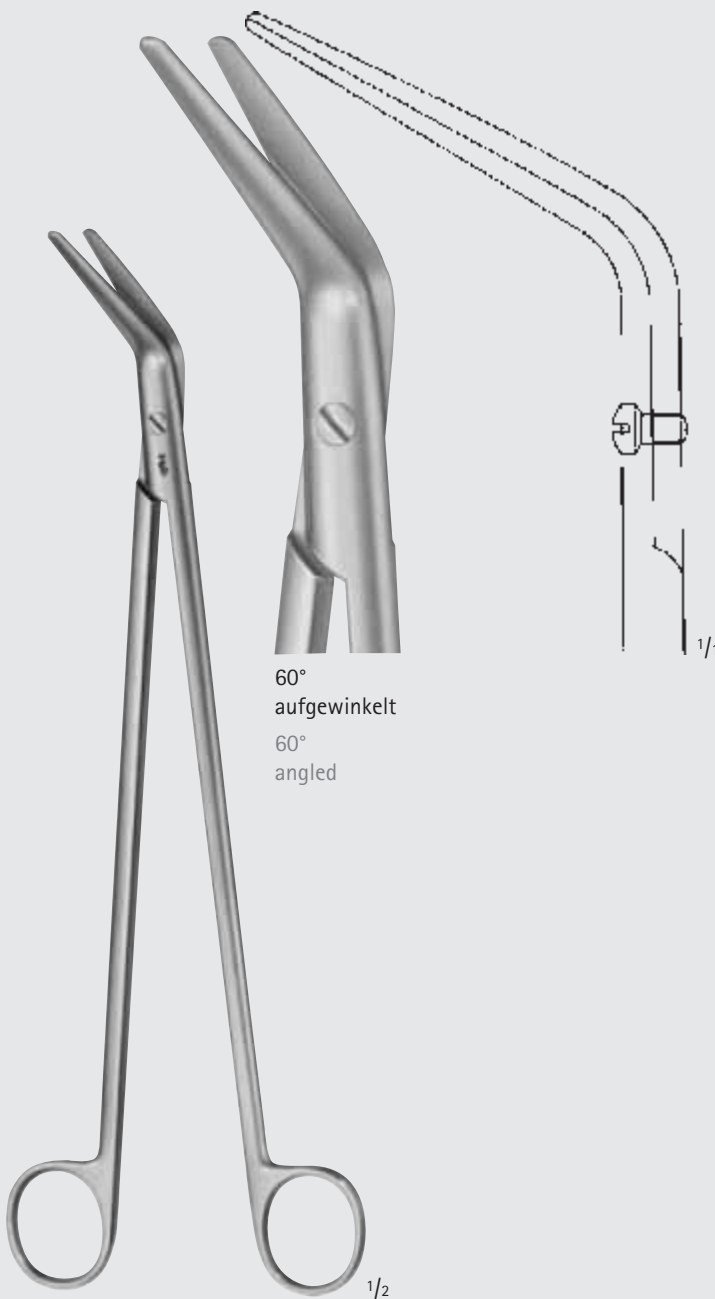

60°  
aufgewinkelt  
60°  
angled

**BC624R**

Präparierschere  
zum Durchtrennen des Darms nach  
erfolgter Naht mit einem Naht-Gerät  
Dissecting scissors  
for cutting of the bowel after  
suturing with suture device  
280 mm, 11"

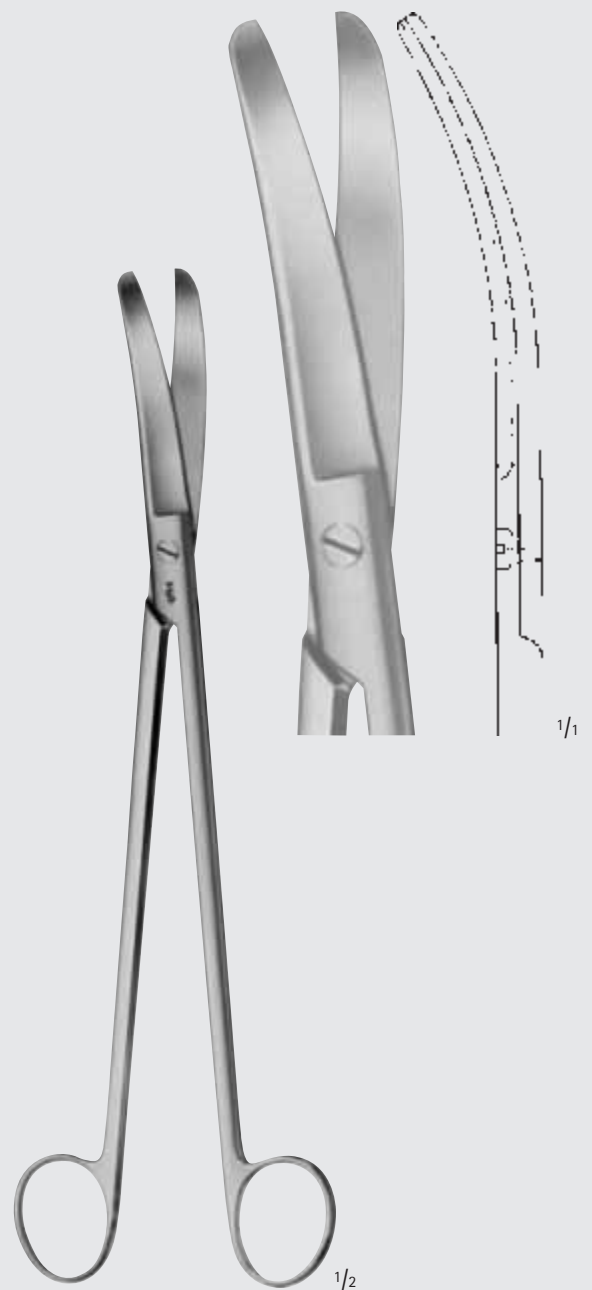

LLOYD-DAVIES (GOLIGHER'S)

**BC621R**

Rektumschere  
Rectal scissors  
270 mm, 10 3/4"



MILLIMETERS

## Scheren – Scissors

Rektumscheren

Rectal Scissors

BC

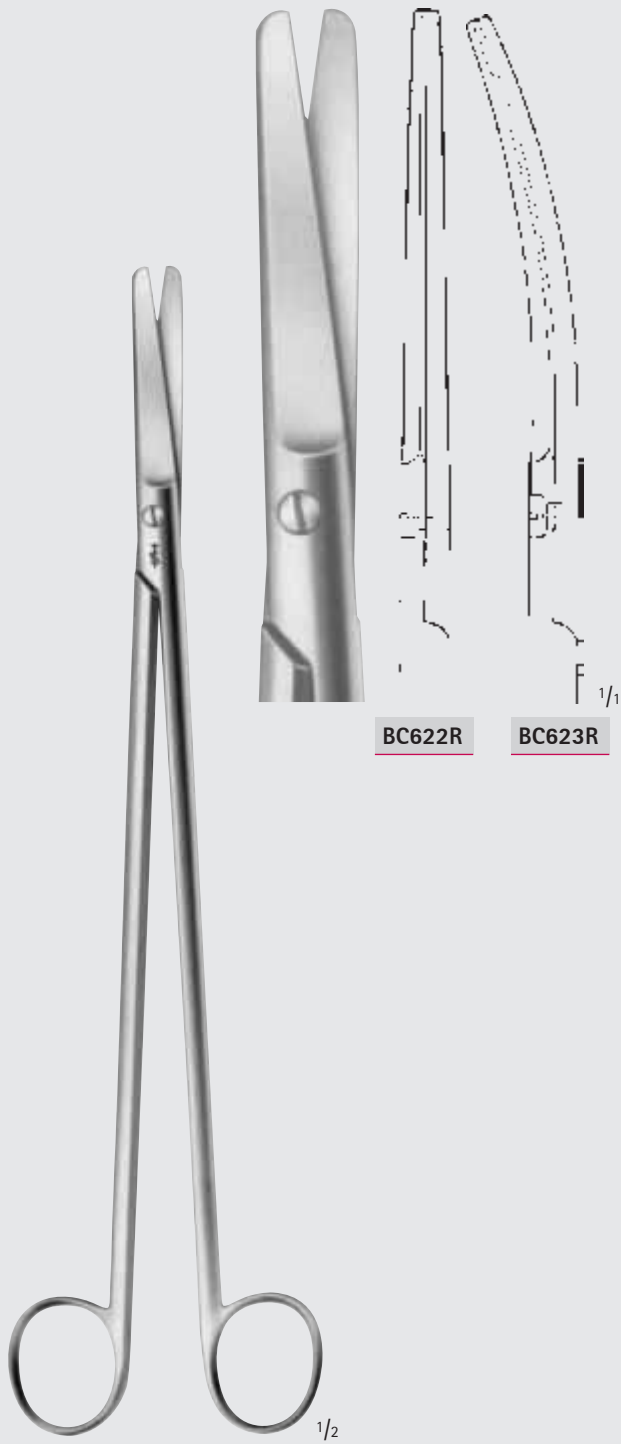

BC622R

BC623R

STELZNER

BC622R-BC623R

Rektumscheren

Rectal scissors

310 mm, 12 3/8"



BC617R

Rektumschere

Rectal scissors

325 mm, 13"



Scheren – Scissors  
Rektumschere  
Rectal Scissors

BC

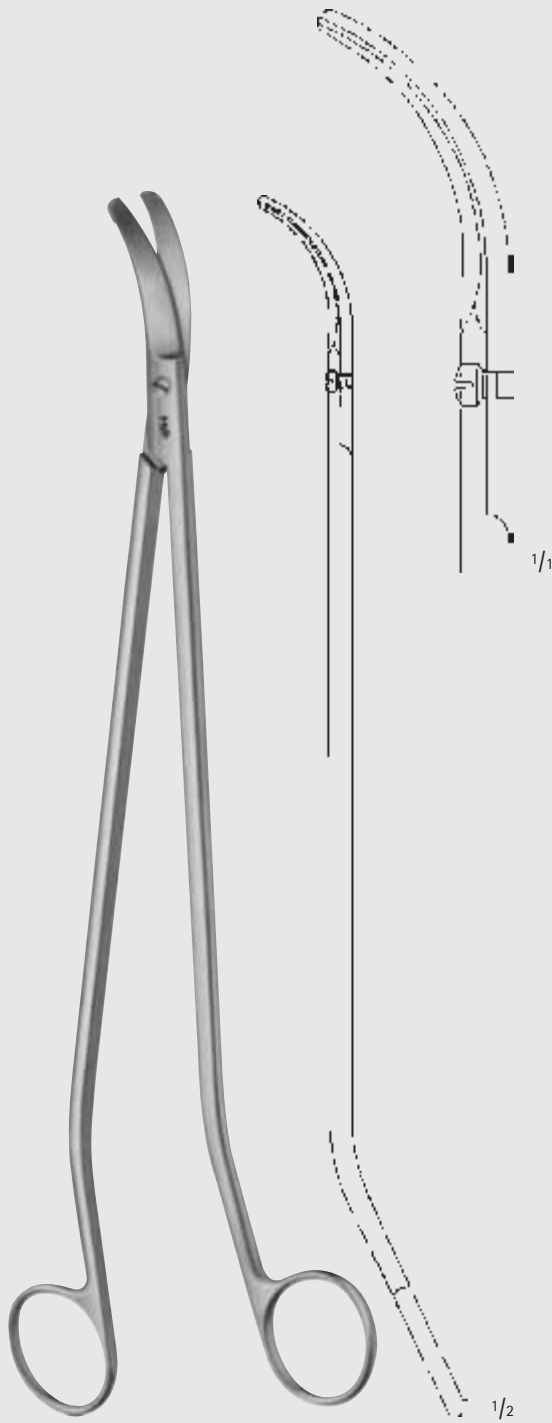

MÜLLER

BC627R

S-förmig

S-shaped

325 mm, 13"

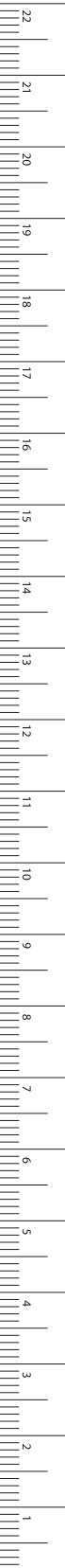

**Scheren – Scissors**

Ligaturscheren

Ligature Scissors

**BC**

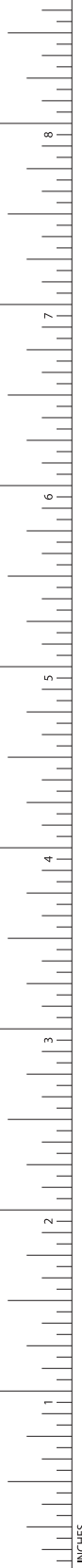

BC801R	BC802R
90 mm	115 mm
3 1/2"	4 1/2"

SPENCER

**BC801R-BC802R**

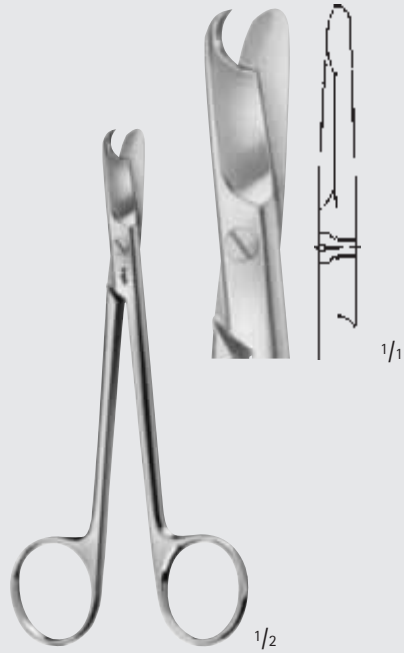

**BC803R**

135 mm, 5 1/4"

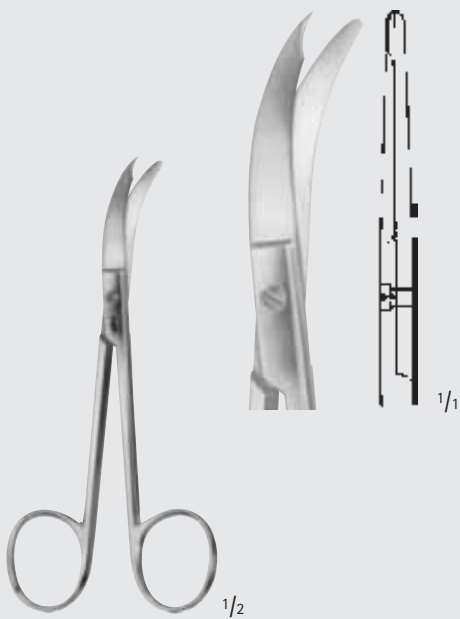

NORTHBENT

**BC805R**

120 mm, 4 3/4"



**Scheren – Scissors**  
 Draht- und Blehscheren  
 Wire Cutting Scissors

**BC**



1/2

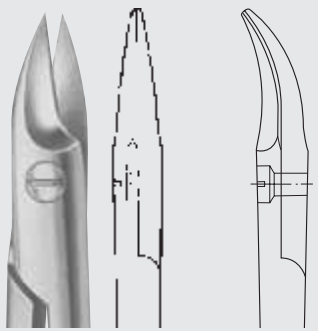

**DP560R**

**DP561R**

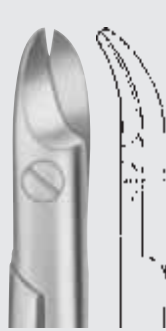

**DP563R**

breite Blätter  
 broad blades

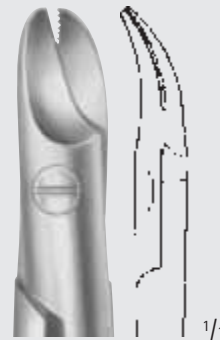

**DP569R**

1 Schneide gezahnt  
 1 blade serrated

**BEEBE**

**DP560R- DP569R**

110 mm, 4 3/8"

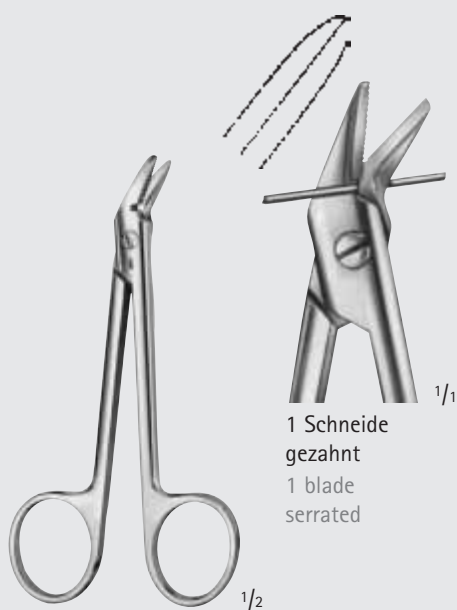

1/2

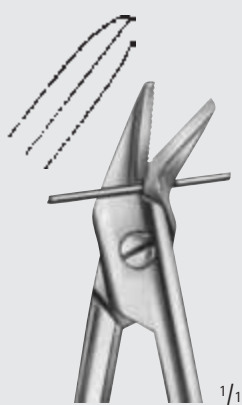

1/1

1 Schneide  
 gezahnt  
 1 blade  
 serrated

**DP551R**

120 mm, 4 3/4"

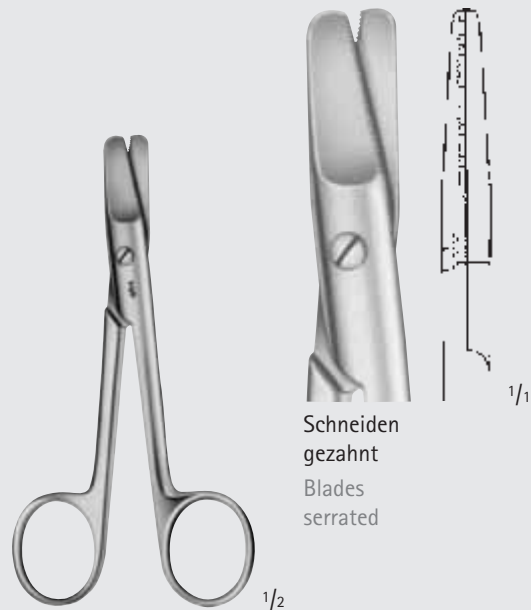

1/2

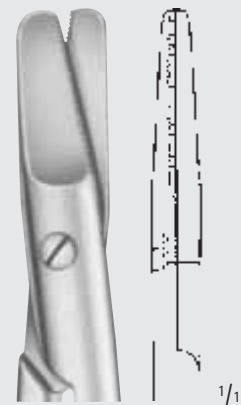

1/1

Schneiden  
 gezahnt  
 Blades  
 serrated

**HARVEY**

**BC815R**

125 mm, 5"



MILLIMETERS

**Scheren – Scissors**  
 Nagelscheren  
 Nail Scissors

BC



**HF400R**

Nagelschere  
 Nail scissors  
 90 mm, 3 1/2"

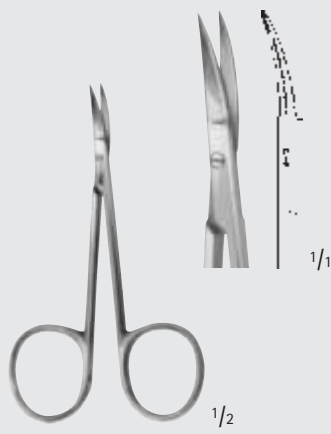

**HF409R**

Nagelschere,  
 extra feines Modell  
 Nail scissors,  
 especially delicate pattern  
 90 mm, 3 1/2"



**HF032R**

Baby-Nagelschere  
 Baby nail scissors  
 85 mm, 3 1/8"

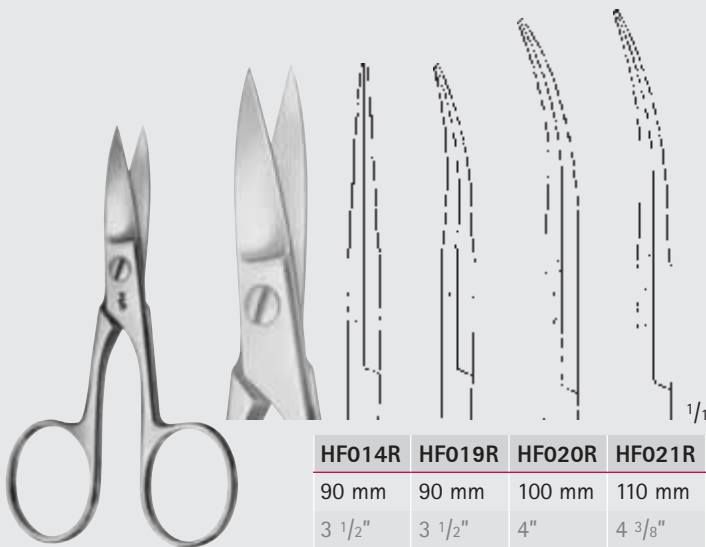

HF014R	HF019R	HF020R	HF021R
90 mm	90 mm	100 mm	110 mm
3 1/2"	3 1/2"	4"	4 3/8"

**HF014R-HF021R**

Nagelscheren  
 Nail scissors



HF028R	HF030R	HF031R
95 mm	95 mm	105 mm
3 3/4"	3 3/4"	4 1/8"

**HF028R-HF031R**

Nagelscheren  
 Nail scissors





## Scheren – Scissors

Verbandstoff- und Verbandscheren

Bandage Scissors

BC

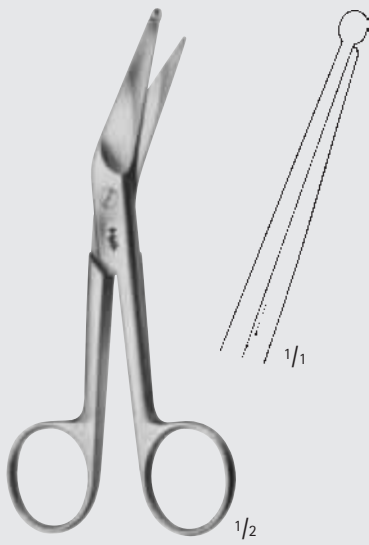

KNOWLES

**BC847R**

140 mm, 5 1/2"

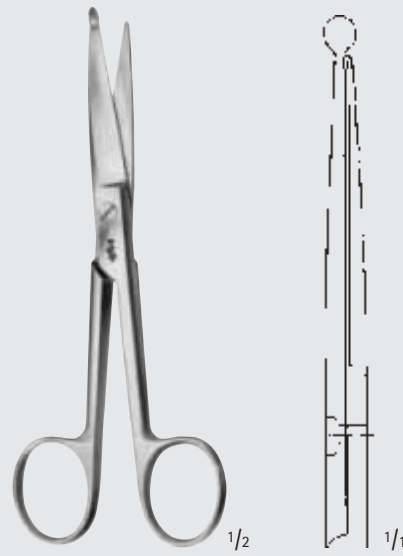

KNOWLES

**BC846R**

145 mm, 5 3/4"

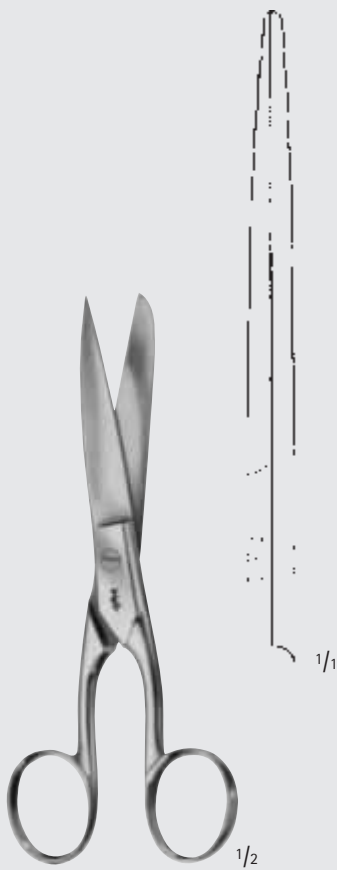

**BC835R**

150 mm, 6"

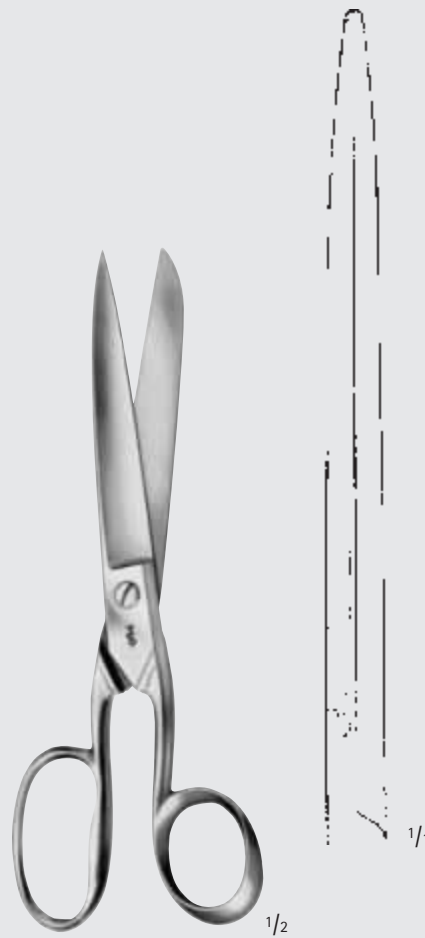

SMITH

**BC838R**

180 mm, 7"

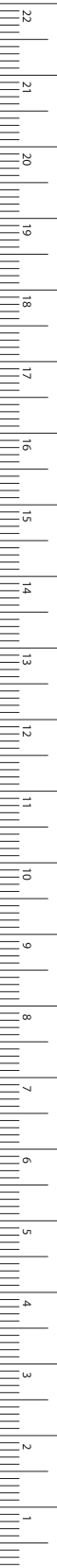

MILLIMETERS

## Scheren – Scissors

Verband- und Kleiderscheren

Bandage- and Cloth Scissors

BC



LISTER

### BC885R-BC979R

<b>BC885R</b>	schwarz	black	<b>BC975R</b>	orange	orange
<b>BC970R</b>	rot	red	<b>BC977R</b>	pink	pink
<b>BC971R</b>	blau	blue	<b>BC978R</b>	hellgrün	light green
<b>BC973R</b>	gelb	yellow	<b>BC979R</b>	violett	violet

Universal Verband- und Kleiderstoffschere, mit gezahnten Schneiden, autoklavierbar bis 143 °C (3 bar)

Universal bandage- and cloth scissors, with toothed edges, autoclavable up to 143 °C (3 bar)

145 mm, 5 3/4"



### BC881R-BC989R

<b>BC881R</b>	schwarz	black	<b>BC985R</b>	orange	orange
<b>BC980R</b>	rot	red	<b>BC987R</b>	pink	pink
<b>BC981R</b>	blau	blue	<b>BC988R</b>	hellgrün	light green
<b>BC983R</b>	gelb	yellow	<b>BC989R</b>	violett	violet

Universal Verband- und Kleiderstoffschere, mit gezahnten Schneiden, autoklavierbar bis 143 °C (3 bar)

Universal bandage- and cloth scissors, with toothed edges, autoclavable up to 143 °C (3 bar)

180 mm, 7"

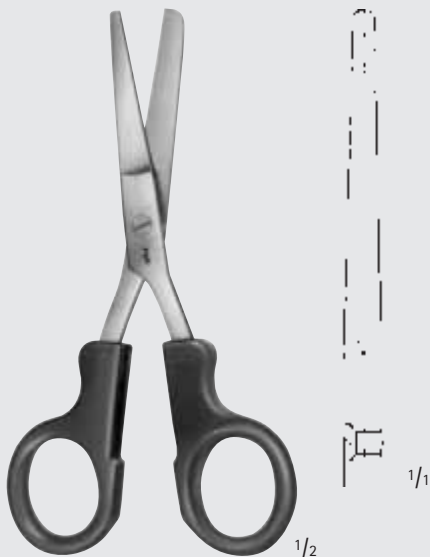

### BC890R

Schwesternschere, autoklavierbar bis 143°C (3 bar)

Nurse's scissors, autoclavable up to 143°C (3 bar)

145 mm, 5 3/4"





**Scheren – Scissors**  
 Verband- und Kleiderscheren  
 Bandage- and Cloth Scissors

**BC**

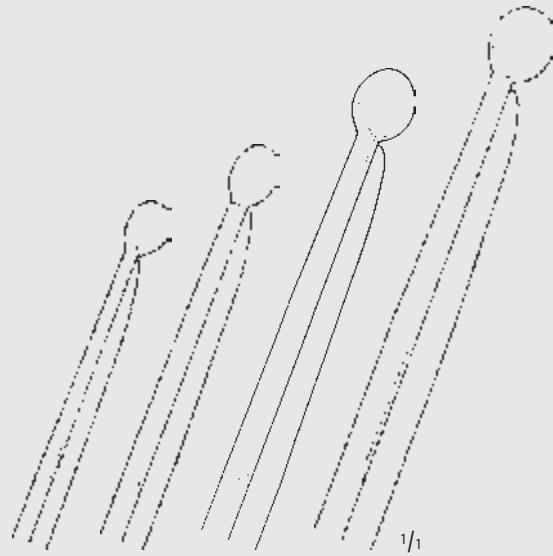

BC860R	BC861R	BC862R	BC863R
115 mm	140 mm	180 mm	200 mm
4 1/2"	5 1/2"	7"	8"

LISTER

**BC860R-BC860R**

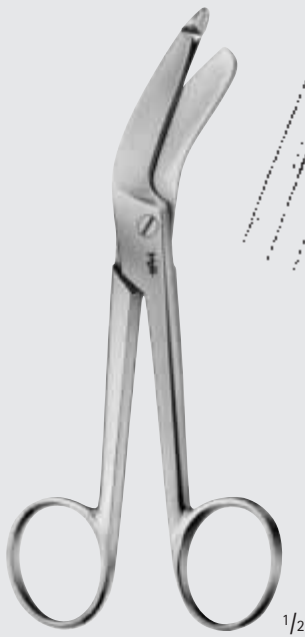

LISTER

**BC876R**

160 mm, 6 1/4"

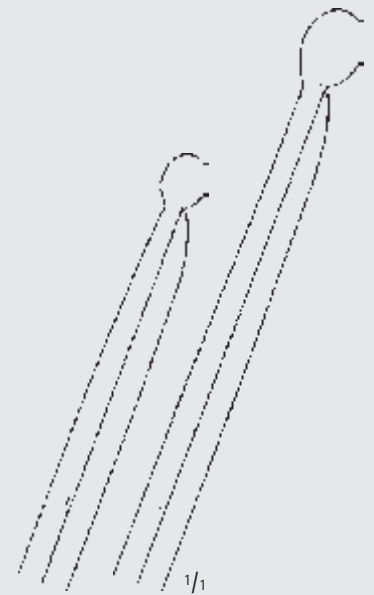

BC848R	BC849R
155 mm	180 mm
6"	7"

LISTER

**BC848R-BC849R**



MILLIMETERS

## Scheren – Scissors

Verbands-, Kleider- und Gipscheren  
Bandage-, Cloth- and Plaster Scissors

BC

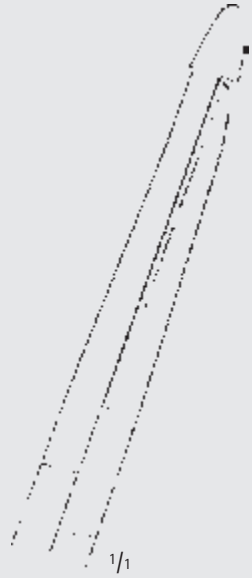

**BC888R**

Kleiderschere  
Cloth scissors  
205 mm, 8"

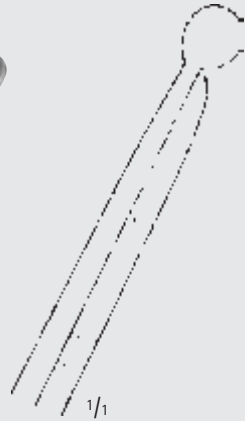

**LX548R**

für kleine Gipsverbände  
for small plaster dressings  
160 mm, 6 1/4"

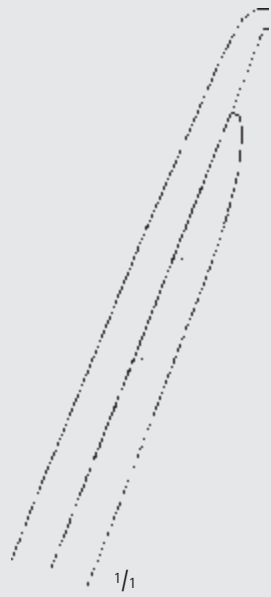

SEUTIN

**LX565R**

230 mm, 9"

INCHES



**Scheren – Scissors**  
 Gipsscheren  
 Plaster Scissors

**BC**

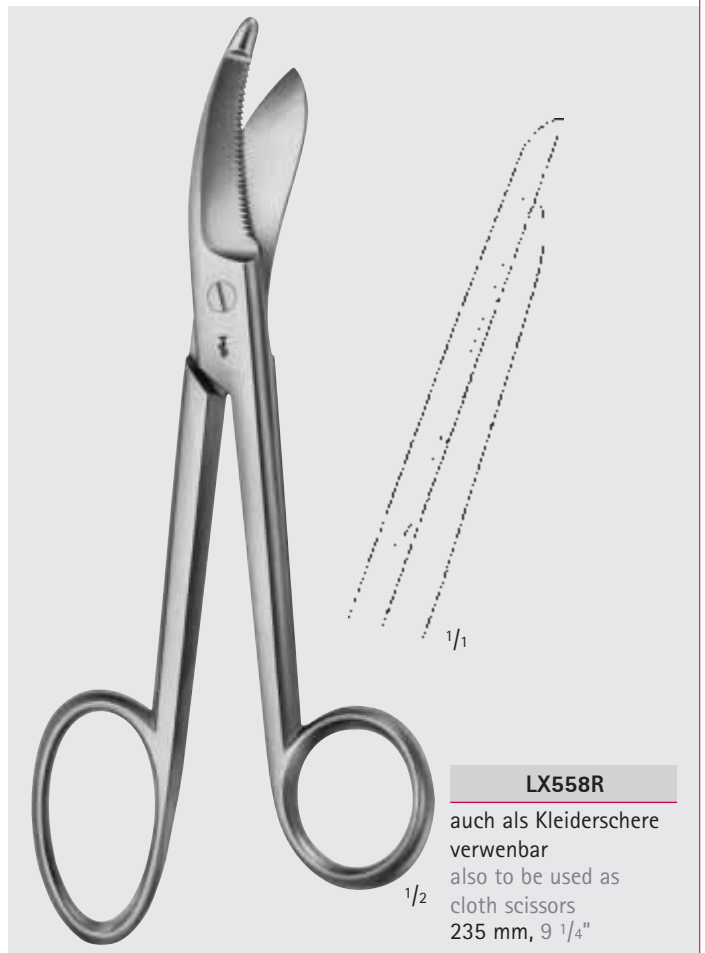
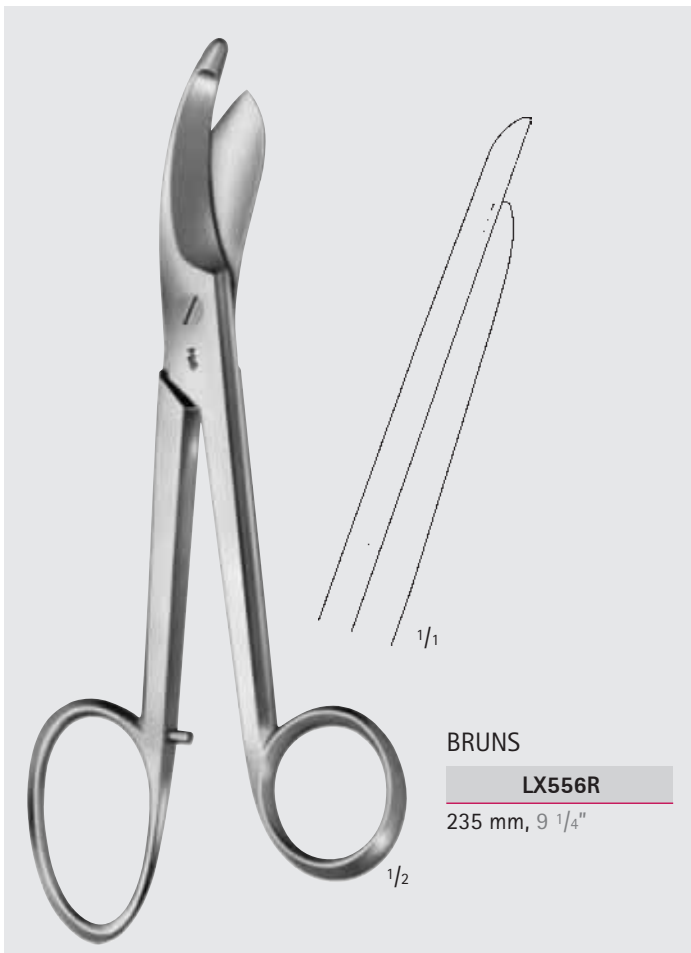
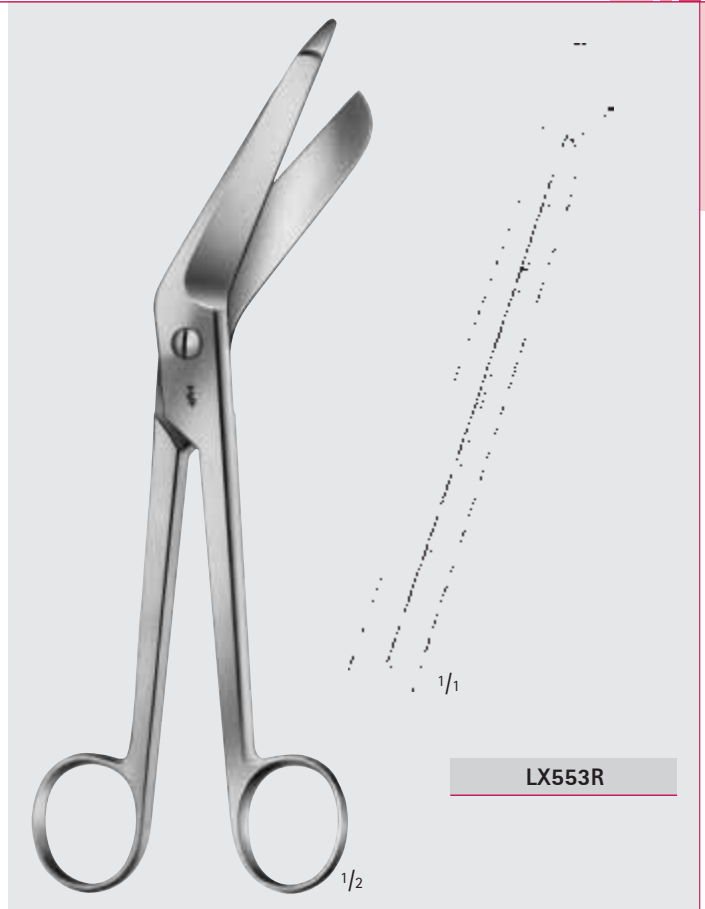
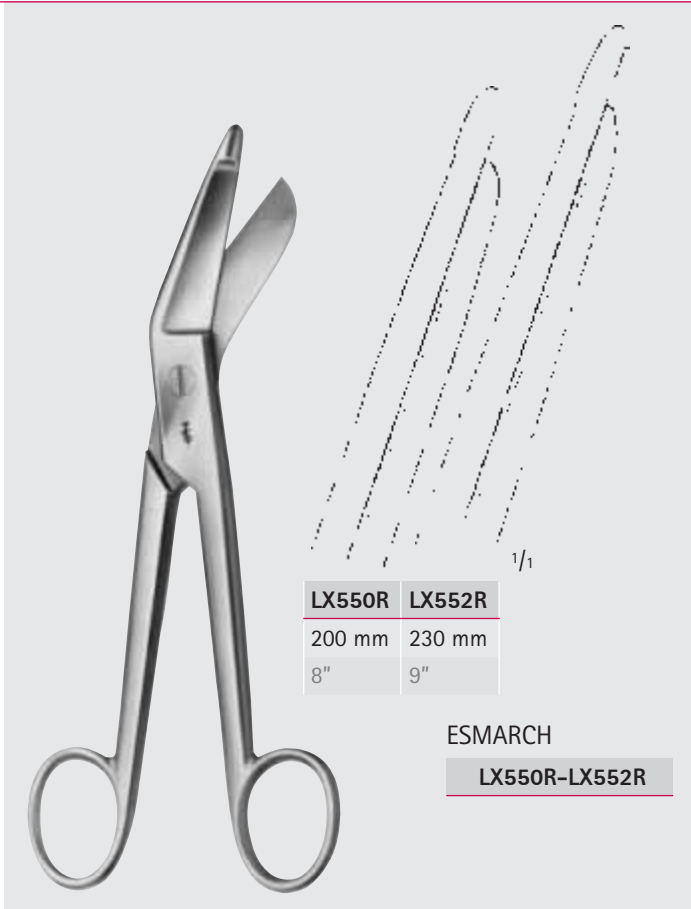

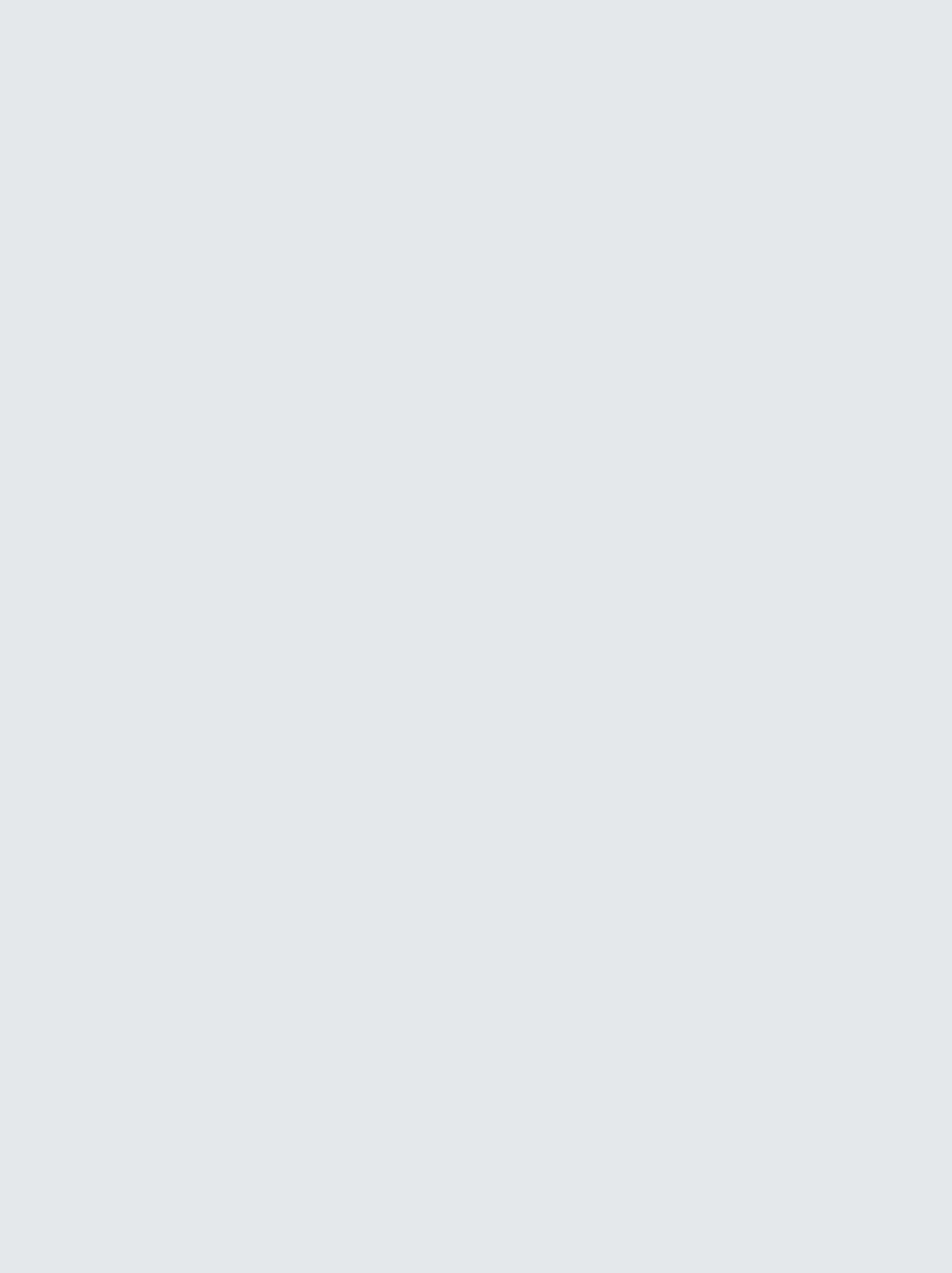



BD



**Pinzetten**

Dissecting- and Tissue Forceps

## Pinzetten – Dissecting- and Tissue Forceps

Mikro-Pinzetten, Uhrmacher Modelle

Micro Forceps, Jeweler Patterns

BD

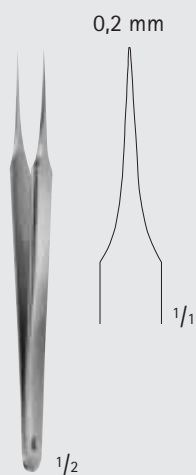

**BD330R**

110 mm, 4 3/8"

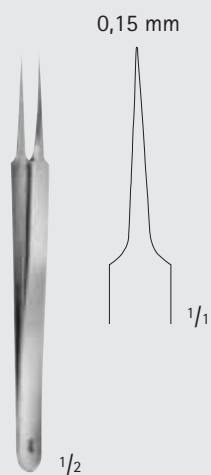

**BD331R**

110 mm, 4 3/8"

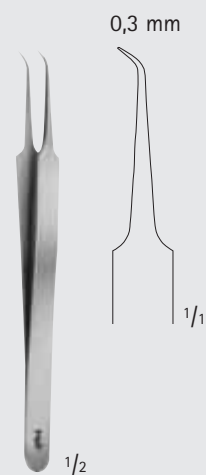

**BD329R**

110 mm, 4 3/8"

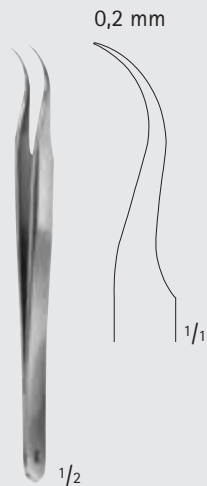

**BD333R**

115 mm, 4 1/2"



**BD343R**

115 mm, 4 1/2"

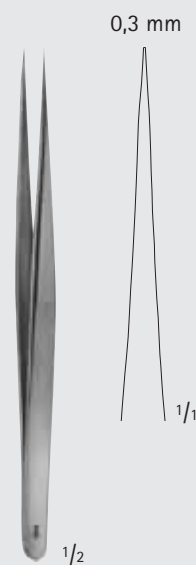

**BD335R**

135 mm, 5 1/4"

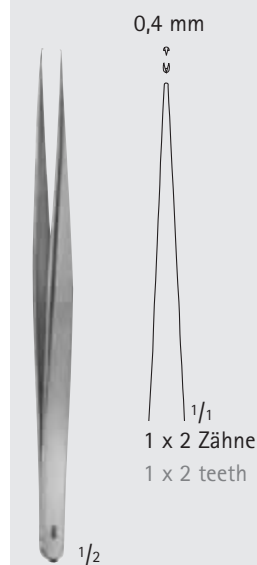

**BD345R**

135 mm, 5 1/4"



## Pinzetten – Dissecting- and Tissue Forceps

Mikro-Knüpfpinzetten  
Mico Suture Tying Forceps

BD

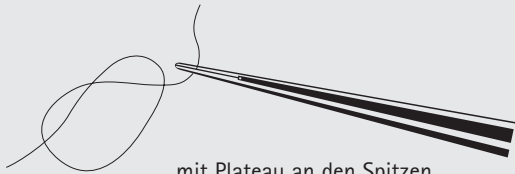

mit Plateau an den Spitzen  
with plateau at the tips



0,2 mm

1/1

mit plateau  
1 x 2 Zähne  
with plateau  
1 x 2 teeth

1/2

BONNER MODELL

**BD505R**

95 mm, 3 3/4"

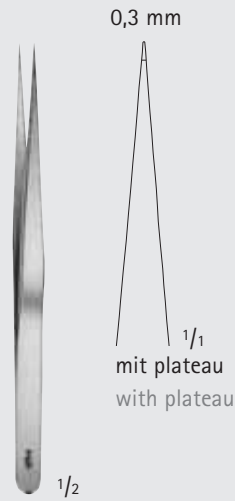

0,3 mm

1/1

mit plateau  
with plateau

1/2

**BD338R**

120 mm, 4 3/4"

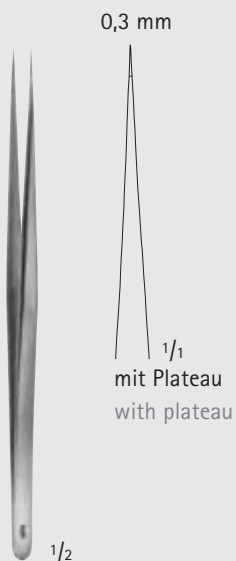

0,3 mm

1/1

mit Plateau  
with plateau

1/2

WISE

**BD336R**

135 mm, 5 1/4"

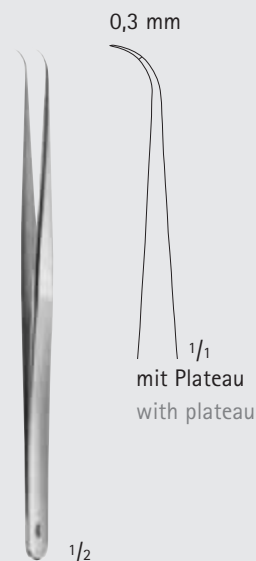

0,3 mm

1/1

mit Plateau  
with plateau

1/2

WISE

**BD337R**

135 mm, 5 1/4"



MILLIMETERS

## Pinzetten – Dissecting- and Tissue Forceps

Mikro-Knüpfpinzetten

Mico Suture Tying Forceps

BD

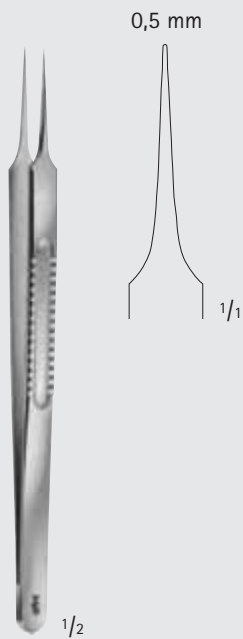

LAZAR

**BD260R**

155 mm, 6"

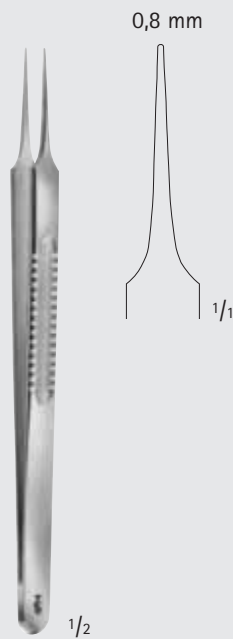

LAZAR

**BD261R**

155 mm, 6"

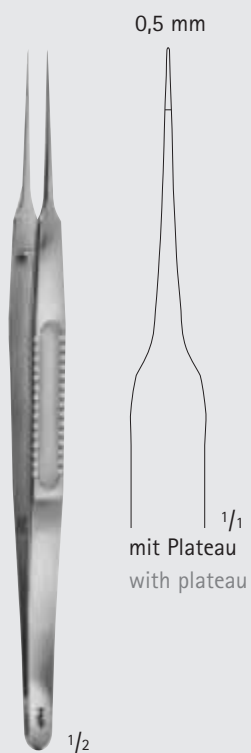

mit Plateau  
with plateau

**BD264R**

185 mm, 7 1/4"

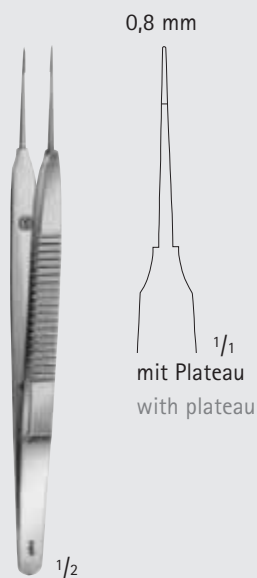

mit Plateau  
with plateau

AUSTIN

**BD340R**

140 mm, 5 1/2"







## Pinzetten – Dissecting- and Tissue Forceps

### Mikro-Pinzetten mit leichtem Kunststoffgriffprofil

### Micro Forceps with Lightweight Plastic Handle



#### Das MÜLLER Mikro-Instrumentarium

Ein neues, hochwertiges Set für die periphere Mikrochirurgie. Zahlreiche praxisbewährte Details führen zu mehr Effektivität und Sicherheit.

#### ■ Unverkrampte Haltung = mehr Feingefühl

Das leichte Kunststoffprofil vergrößert die Griffoberfläche, gewährleistet dadurch eine unverkrampte Handhaltung und verleiht mehr Feingefühl.

#### ■ Leichteres Drehen = erweiterter Arbeitsbereich

Der runde Griffquerschnitt ermöglicht leichtes, gleichmäßiges Drehen des Instrumentes. Verwendungs- bzw. Arbeitsbereich wird dadurch erweitert.

#### ■ Sicherer Halt

Das griffige Noppenprofil gewährleistet einen durchweg sicheren Halt bei sämtlichen Bewegungsabläufen.

#### ■ Optimales Handling

Eine Entwicklung nach ergonomischen Gesichtspunkten, verbunden mit dem geringen Gewicht der neuen Kunststoffgriffe schaffen die Voraussetzung zu ermüdungsfreiem Arbeiten und optimalem Handling.

#### The MÜLLER Micro instrument system

A top quality set for peripheral microsurgery. Numerous details tried and tested in practice mean increased efficiency and safety.

#### ■ Natural holding position = increased sensitivity

The light plastic profile increases the grip surface, thus guaranteeing a natural hand position without cramping and providing enhanced sensitivity.

#### ■ Easier rotation = extended working area

The round grip cross section permits easy and uniform rotation of the instrument. This extends the application and working areas.

#### ■ Safe grip

The easy grip studded profile guarantees a secure hold for all movements.

#### ■ Optimum handling

Development in accordance with ergonomic criteria and the low weight of the new plastic grips provide fatiguefree working and optimum handling.

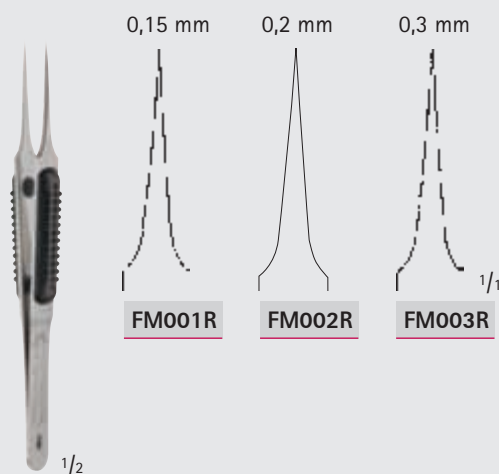

MÜLLER

**FM001R-FM003R**

110 mm, 4 3/8"

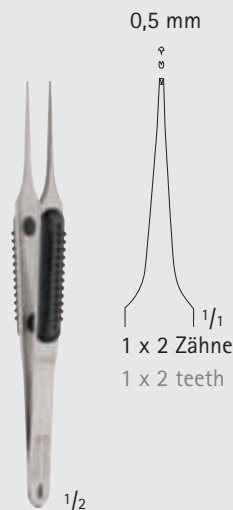

MÜLLER

**FM004R**

110 mm, 4 3/8"

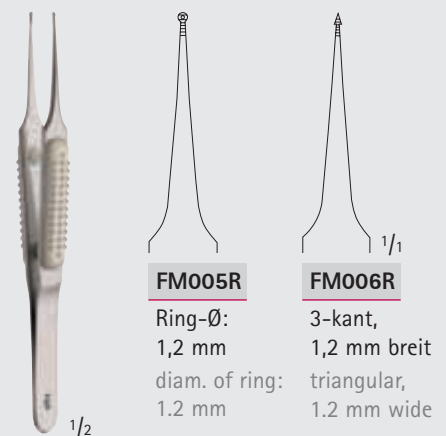

MÜLLER

**FM005R-FM006R**

110 mm, 4 3/8"

BD

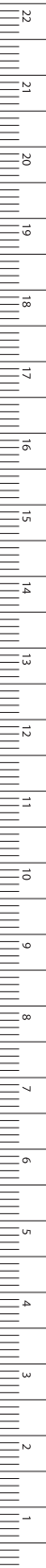

MILLIMETERS

## Pinzetten – Dissecting- and Tissue Forceps

Mikro-Pinzetten mit leichtem Kunststoffgriffprofil

Micro Forceps with Lightweight Plastic Handle

BD



0,3 mm

**FM033R**

0,4 mm

**FM036R**

mit Plateau  
with plateau

MÜLLER  
**FM033R-FM036R**

160 mm, 6 1/4"



0,5 mm



1 x 2 Zähne  
1 x 2 teeth

MÜLLER  
**FM034R**

160 mm, 6 1/4"



1,2 mm  
Ring-Ø  
diam. of ring  
1.2 mm

MÜLLER  
**FM035R**

160 mm, 6 1/4"



## Pinzetten – Dissecting- and Tissue Forceps

### Mikro-Knüpfpinzetten mit Rundgriffen

#### Micro Suture Tying Forceps with Round Handle

##### ... mit Rundgriffen

- Rundgriffe erlauben Drehbewegungen zwischen den Fingern.
- Optimale Balance, individuell je nach Instrument, durch volle oder gehöhlte Griffpartien.

##### ... with round handles

- Round handles allow turning manipulations between the fingers.
- Optimum balance individually for each instrument due to solid or hollowed-out handles.

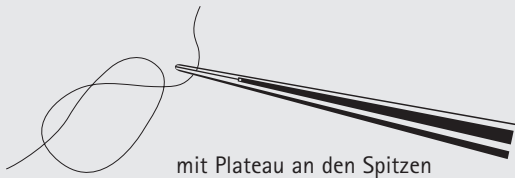

mit Plateau an den Spitzen  
with plateau at the tips

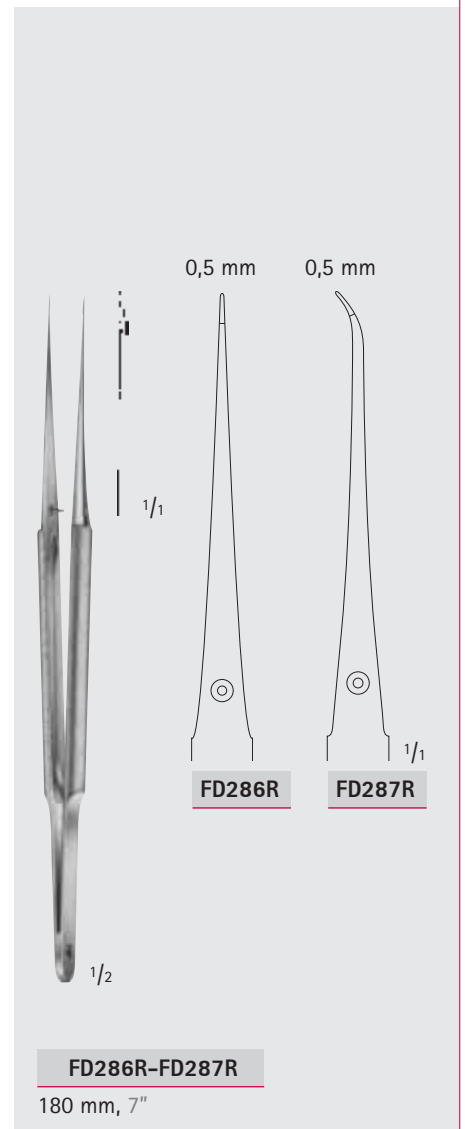
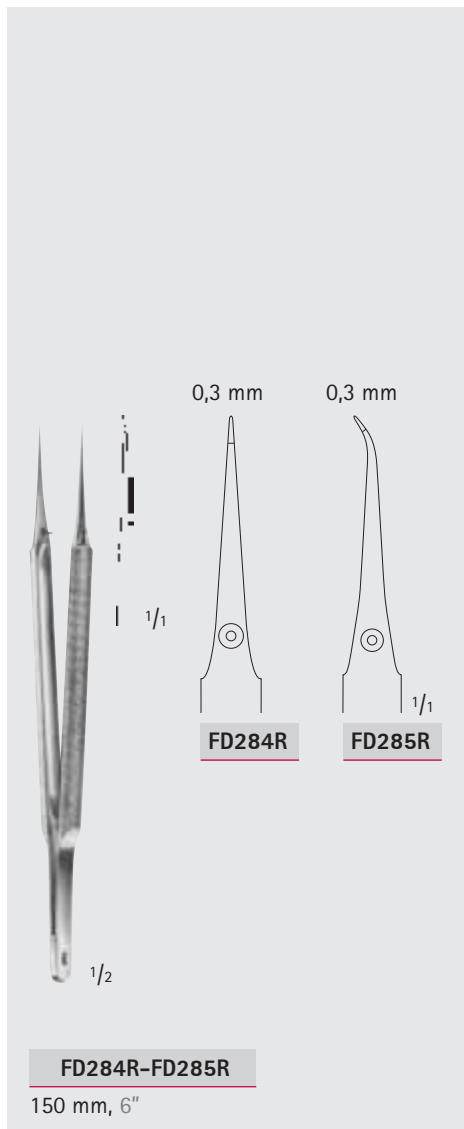
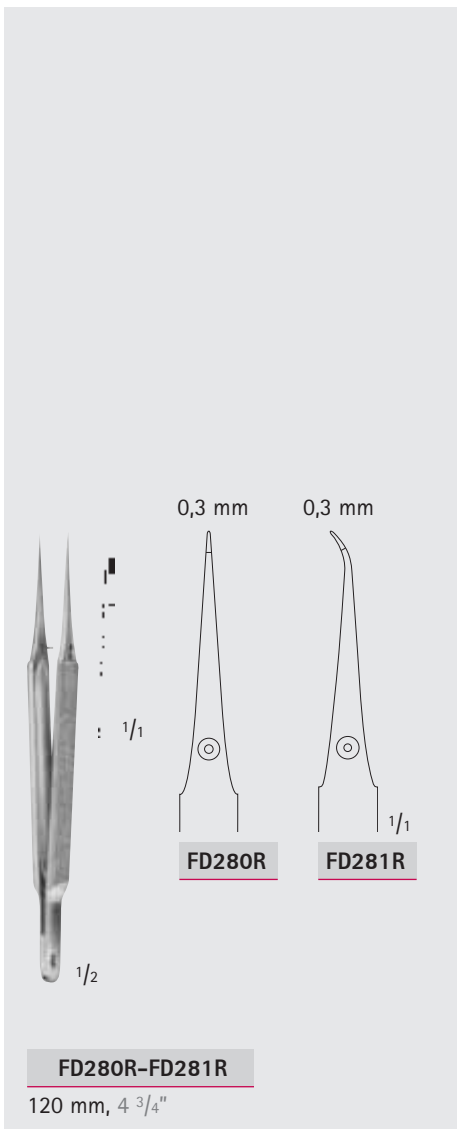

BD

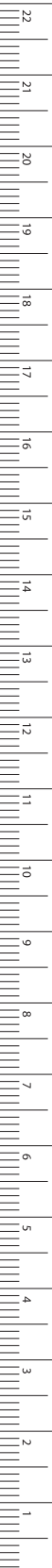

MILLIMETERS

## Pinzetten – Dissecting- and Tissue Forceps

Mikro-Pinzetten mit Rundgriff und Gewicht

Micro Forceps with Round Handles and Counter Balance

BD

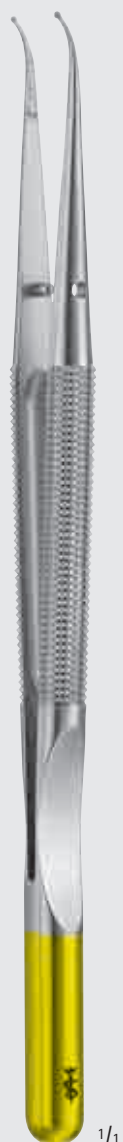

150 mm, 6"  $\frac{1}{1}$

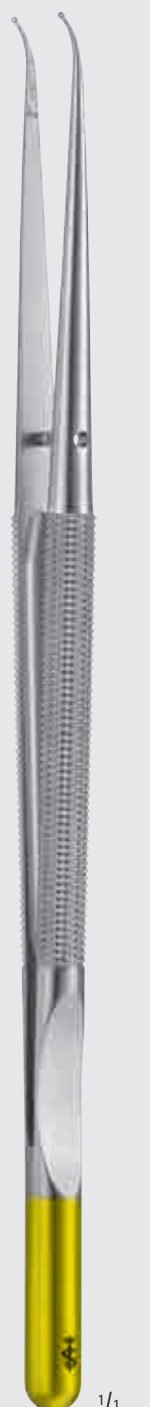

185 mm, 7  $\frac{1}{4}$ "  $\frac{1}{1}$

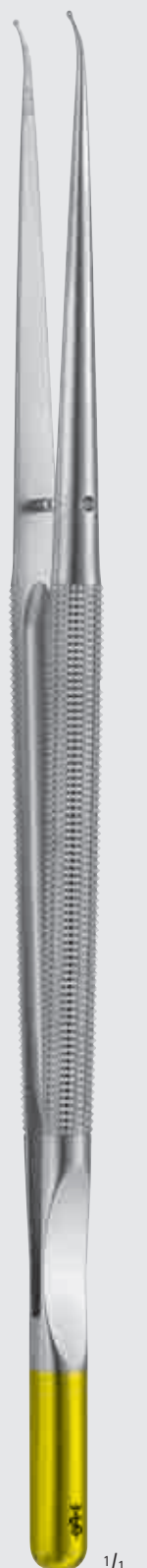

210 mm, 8  $\frac{1}{4}$ "  $\frac{1}{1}$

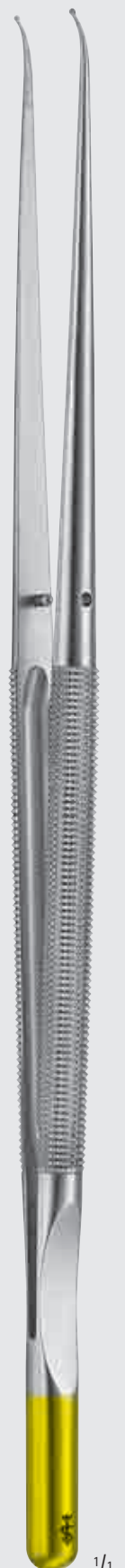

230 mm, 9"  $\frac{1}{1}$



250 mm, 10"  $\frac{1}{1}$



## Pinzetten – Dissecting- and Tissue Forceps

### Mikro-Pinzetten mit Rundgriff und Gewicht

### Micro Forceps with Round Handles and Counter Balance

BD



DIADUST



Die Diamantstaubbeschichtung sorgt für eine noch härtere und verschleißfestere Maulinnenfläche. Darüber hinaus garantiert die Struktur der DIADUST-Beschichtung ein zuverlässiges Fassen von feinen Nadeln und Nahtmaterialien sowie von Weichgewebe.

The diamond dust coating ensures an even harder and more wear resistant surface on the inside of the jaws. Moreover, the structure of the DIADUST coating guarantees a reliable grip for fine needles and sutures, as well as for tissue.

Maulform  
Jaw

Ring-Ø:  
1 mm,  
gerade  
diam. of ring:  
1 mm,  
straight



Ring-Ø:  
1 mm,  
gebogen  
diam. of ring:  
1 mm,  
curved



Ring-Ø:  
2 mm,  
gerade  
diam. of ring:  
2 mm,  
straight



Fadenplatte,  
gerade  
Platform tips,  
straight



Fadenplatte,  
gebogen  
Platform tips,  
curved



1 mm,  
DeBakey  
Zahnung  
1 mm,  
DeBakey tip



Länge (mm)  
Length (in.)

150 mm  
6"

**FM570R**

**FM571R**

**FM578R**

**FM581R**

185 mm  
7 1/4"

**FM572R**

**FM573R**

**FM579R**

**FM580R**

**FM583R**

**FM592R**

210 mm  
8 1/4"

**FM574R**

**FM575R**

**FM599R**

**FM585R**

**FM600R**

230 mm  
9"

**FM576R**

**FM577R**

250 mm  
10"

**FM596R**

**FM595R**

**FM594R**

**FM593R**

MILLIMETERS

## Pinzetten – Dissecting- and Tissue Forceps

Mikro-Pinzetten mit Rundgriff, ohne Gewicht

Micro Forceps with Round Handles, without Counter Balance

BD



$\frac{1}{1}$   
185 mm, 7  $\frac{1}{4}$ "

$\frac{1}{1}$   
210 mm, 8  $\frac{1}{4}$ "



## Pinzetten – Dissecting- and Tissue Forceps

Mikro-Pinzetten mit Rundgriff, ohne Gewicht

Micro Forceps with Round Handles, without Counter Balance

BD



MILLIMETERS

DIADUST



Die Diamantstaubbeschichtung sorgt für eine noch härtere und verschleißfestere Maulinnenfläche. Darüber hinaus garantiert die Struktur der DIADUST-Beschichtung ein zuverlässiges Fassen von feinen Nadeln und Nahtmaterialien sowie von Weichgewebe.

The diamond dust coating ensures an even harder and more wear resistant surface on the inside of the jaws. Moreover, the structure of the DIADUST coating guarantees a reliable grip for fine needles and sutures, as well as for tissue.

Maulform  
Jaw

Ring-Ø:  
1 mm,  
gerade  
diam. of ring:  
1 mm,  
straight



Ring-Ø:  
1 mm,  
gebogen  
diam. of ring:  
1 mm,  
curved



Ring-Ø:  
1 mm mit  
Fadenplatte  
diam. of ring:  
1 mm with  
platform tip



Fadenplatte,  
gerade  
Platform tip,  
straight



1 mm,  
DeBakey  
Zahnung  
1 mm,  
DeBakey tip



Länge (mm)  
Length (in.)

185 mm  
7 1/4"

**FM597R**

**FM587R**

**FM582R**

**FM586R**

**FM590R**

210 mm  
8 1/4"

**FM598R**

**FM589R**

**FM584R**

**FM588R**

**FM591R**

## Pinzetten – Dissecting- and Tissue Forceps

Mikro-Pinzetten mit Flachgriff

Micro Forceps with Flat Handle

BD

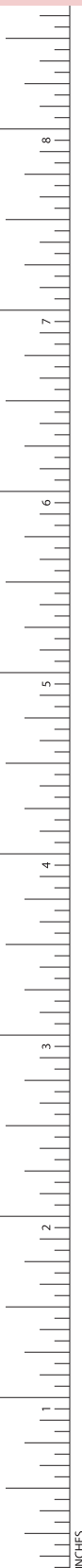

180 mm, 7"  $\frac{1}{1}$



200 mm, 8"  $\frac{1}{1}$



250 mm, 10"  $\frac{1}{1}$





## Pinzetten – Dissecting- and Tissue Forceps

### Mikro-Pinzetten mit Flachgriff

### Micro Forceps with Flat Handle

BD



DIADUST



Die Diamantstaubbeschichtung sorgt für eine noch härtere und verschleißfestere Maulinnenfläche. Darüber hinaus garantiert die Struktur der DIADUST-Beschichtung ein zuverlässiges Fassen von feinen Nadeln und Nahtmaterialien sowie von Weichgewebe.

The diamond dust coating ensures an even harder and more wear resistant surface on the inside of the jaws. Moreover, the structure of the DIADUST coating guarantees a reliable grip for fine needles and sutures, as well as for tissue.

Maulform  
Jaw

1 mm,  
Karoprofil

1 mm,  
cross serrated



1 mm,  
DeBakey  
Zahnung

1 mm,  
DeBakey tip



Ring-Ø:  
1 mm,  
gerade

diam. of ring:  
1 mm,  
straight



Ring-Ø:  
1 mm,  
gebogen

diam. of ring:  
1 mm,  
curved



1 mm,  
gerade

1 mm,  
straight



Länge (mm)  
Length (in.)

180 mm  
7"

**BD190R**

**BD191R**

**BD192R**

**BD193R**

**BD194R**

200 mm  
8"

**BD195R**

**BD196R**

250 mm  
10"

**BD197R**

MILLIMETERS

# Pinzetten – Dissecting- and Tissue Forceps

Mikro-Pinzetten

Micro Forceps

BD



1/1  
Karoprofil  
cross serrated

1/2

**FM063R**

Rundgriff  
round handle  
200 mm, 8"



**FM053R**

Ring-Ø: 2,5 mm  
diam. of ring: 2.5 mm

180 mm

7"



**FM054R**

Ring-Ø: 2,5 mm  
diam. of ring: 2.5 mm

200 mm

8"

**FM053R-FM054R**

Rundgriff  
round handle



1/1  
mit Plateau  
with platform tip

1/2

**FD253R**

Rundgriff  
round handle  
180 mm, 7"



## Pinzetten – Dissecting- and Tissue Forceps

Feine anatomische Pinzetten  
Delicate Dissecting Forceps

BD

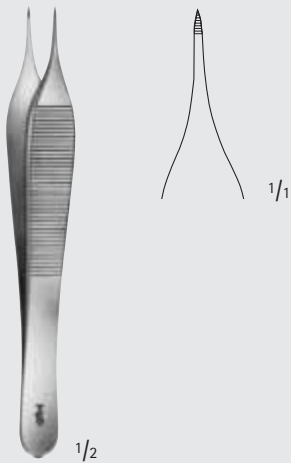

THORPE

**OC069R**

Hornhautpinzette  
Corneal forceps  
120 mm, 4 3/4"

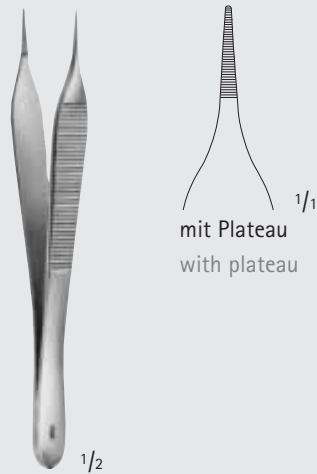

MICRO-ADSON

**BD220R**

120 mm, 4 3/4"

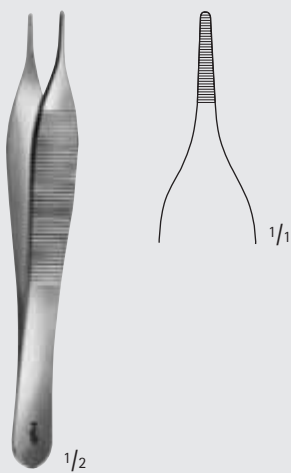

ADSON

**BD222R**

120 mm, 4 3/4"

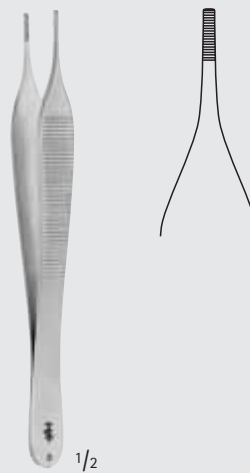

HUDSON

**BD225R**

125 mm, 5"

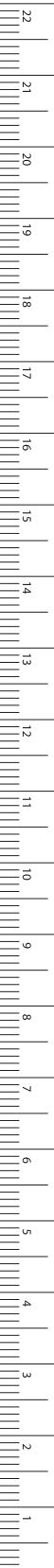

MILLIMETERS

## Pinzetten – Dissecting- and Tissue Forceps

Feine anatomische Pinzetten

Delicate Dissecting Forceps

BD

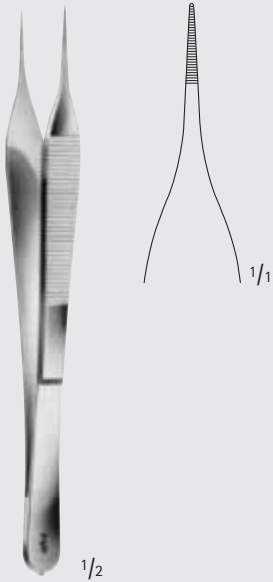

MICRO-ADSON

**BD223R**

150 mm, 6"

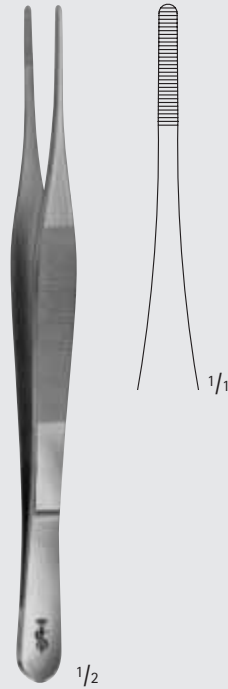

ADSON

**BD224R**

180 mm, 7"

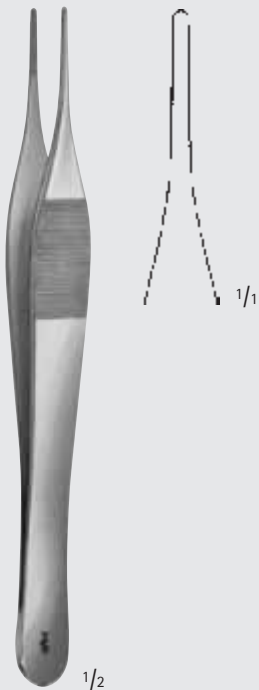

JEFFERSON

**BD226R**

180 mm, 7"

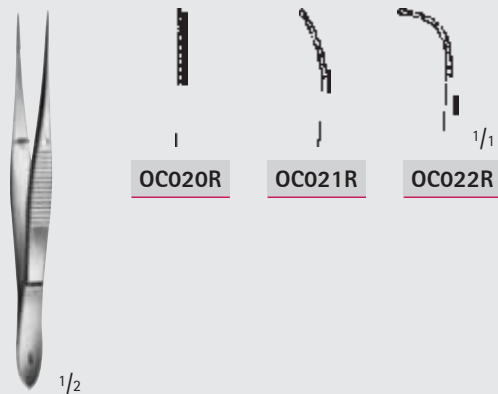

**OC020R**

**OC021R**

**OC022R**

**OC020R-OC022R**

100 mm, 4"





# Pinzetten – Dissecting- and Tissue Forceps

Feine anatomische Pinzetten  
Delicate Dissecting Forceps

**BD**

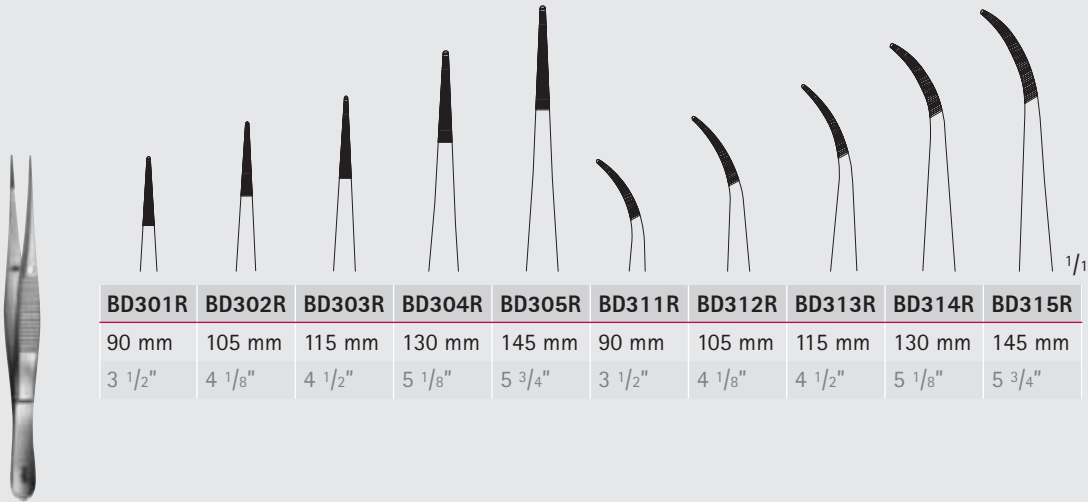

BD301R	BD302R	BD303R	BD304R	BD305R	BD311R	BD312R	BD313R	BD314R	BD315R
90 mm	105 mm	115 mm	130 mm	145 mm	90 mm	105 mm	115 mm	130 mm	145 mm
3 1/2"	4 1/8"	4 1/2"	5 1/8"	5 3/4"	3 1/2"	4 1/8"	4 1/2"	5 1/8"	5 3/4"

**BD301R-BD315R**

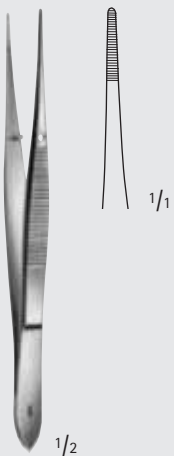

**BD210R**  
115 mm, 4 1/2"



**BD320R**  
100 mm, 4"



**BD321R**  
100 mm, 4"

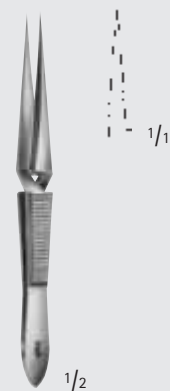

**BD322R**  
100 mm, 4"



MILLIMETERS

# Pinzetten – Dissecting- and Tissue Forceps

Feine anatomische Pinzetten

Delicate Dissecting Forceps

BD

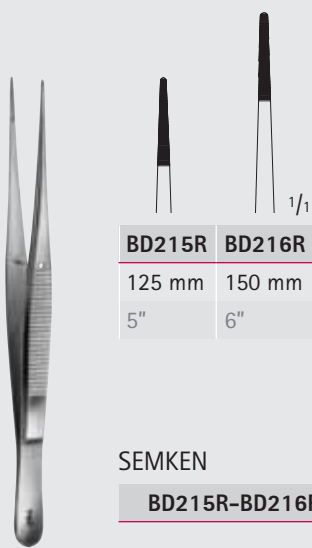

SEMKEN

**BD215R-BD216R**



**BD217R**

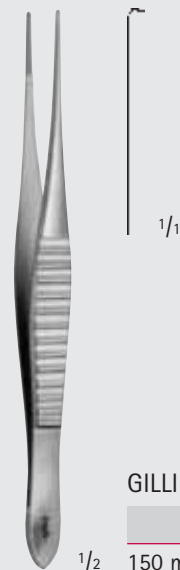

GILLIES

**BD213R**



MC INDOE

**BD236R**

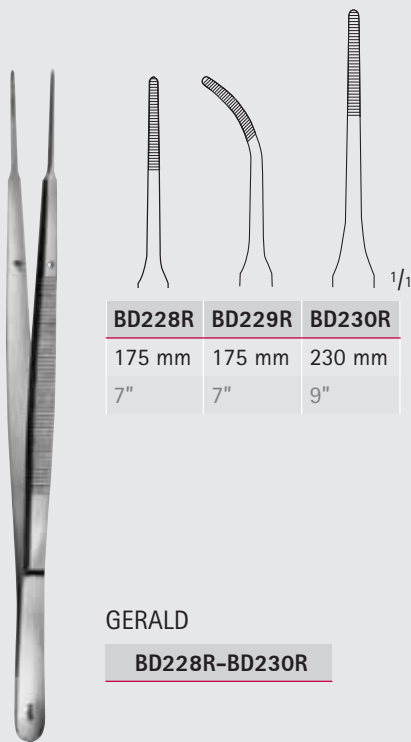

GERALD

**BD228R-BD230R**



CAIRNS-DOTT

**BD268R-BD269R**





# Pinzetten – Dissecting- and Tissue Forceps

## Feine Anatomische Pinzetten

### Delicate Dissecting Forceps

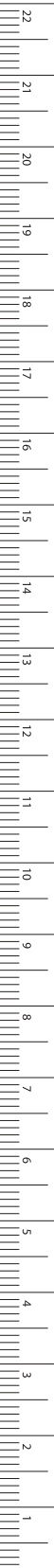
**BD**

BD238R	BD239R	BD243R	BD240R
180 mm	200 mm	200 mm	250 mm
7"	8"	8"	10"

**CUSHING**

**BD238R-BD243R**

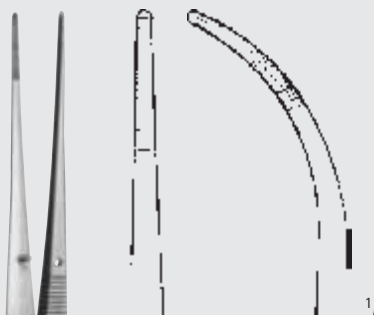

**BROPHY**

**BD246R-BD247R**

1/2 200 mm, 8"



**BD081R**

1/2 200 mm, 8"

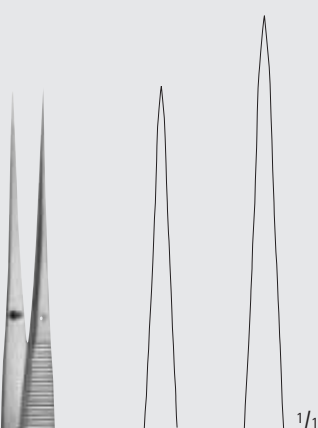

BD231R	BD232R
185 mm	200 mm
7 1/4"	8"

**BD231R-BD232R**

glattes Maul  
smooth jaws

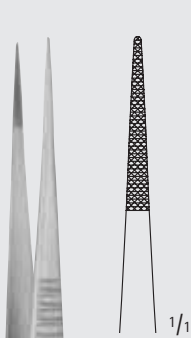

**COOLEY**

**BD250R**

1/2 200 mm, 8"

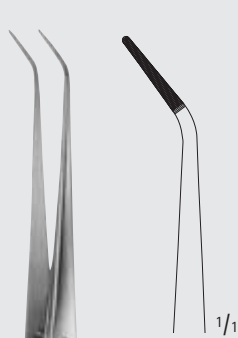

**BD257R**

1/2 200 mm, 8"

## Pinzetten – Dissecting- and Tissue Forceps

Anatomische Pinzetten

Dissecting Forceps

BD

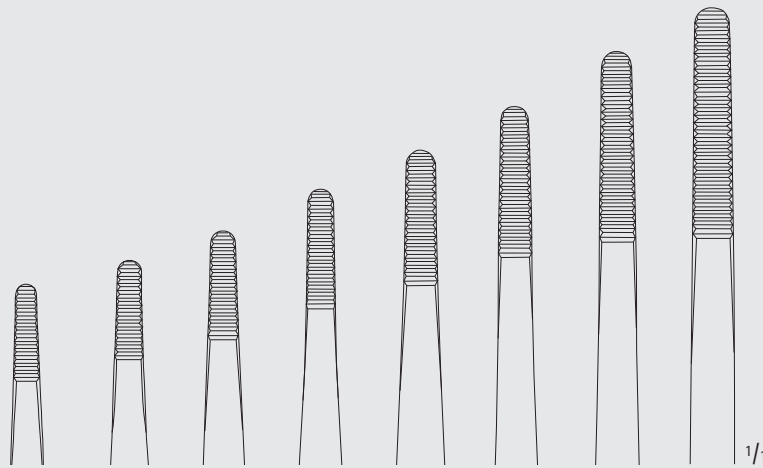

BD043R	BD045R	BD047R	BD049R	BD050R	BD051R	BD052R	BD053R
115 mm	130 mm	145 mm	160 mm	180 mm	200 mm	250 mm	300 mm
4 1/2"	5 1/8"	5 3/4"	6 1/4"	7"	8"	10"	12"

### BD043R-BD053R

Standard-Modelle

Standard patterns

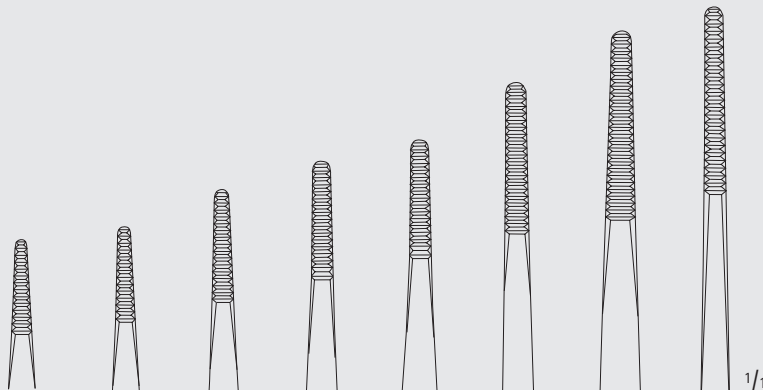

BD023R	BD025R	BD027R	BD029R	BD030R	BD031R	BD032R	BD033R
115 mm	130 mm	145 mm	160 mm	180 mm	200 mm	250 mm	305 mm
4 1/2"	5 1/8"	5 3/4"	6 1/4"	7"	8"	10"	12"

### BD023R-BD033R

mittelbreit

medium





# Pinzetten – Dissecting- and Tissue Forceps

Anatomische Pinzetten  
Dissecting Forceps

BD

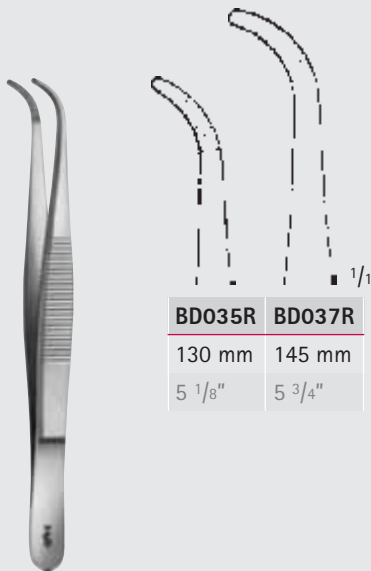

BD035R	BD037R
130 mm	145 mm
5 1/8"	5 3/4"

**BD035R-BD037R**

mittelbreit  
medium

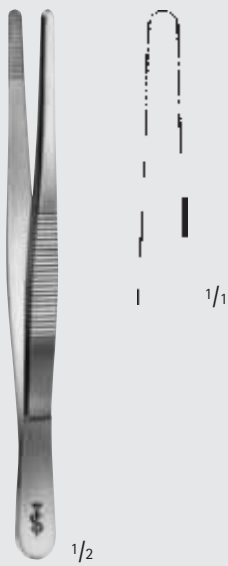

**BD077R**

extra breit  
extra large  
145 mm, 5 3/4"

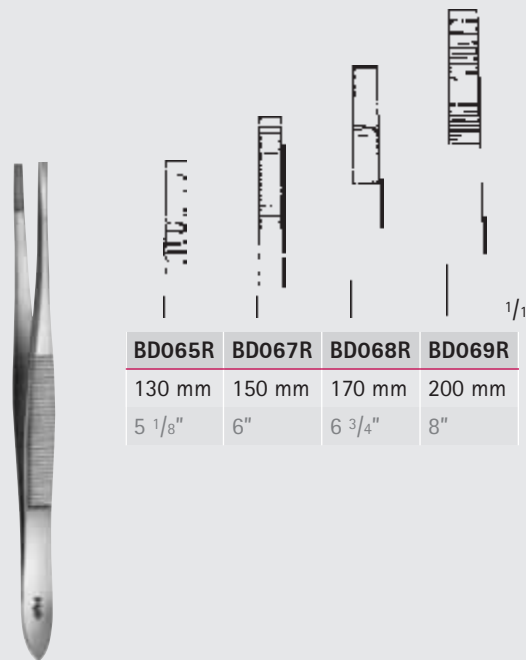

BD065R	BD067R	BD068R	BD069R
130 mm	150 mm	170 mm	200 mm
5 1/8"	6"	6 3/4"	8"

SCHWEDISCHES MODELL

**BD065R-BD069R**



## Pinzetten – Dissecting- and Tissue Forceps

Anatomische Pinzetten

Dissecting Forceps

BD



OCHSNER

**BD130R**

Fadenpinzette

Ligature forceps

145 mm, 5 3/4"



BONNEY

**BD078R**

175 mm, 7"

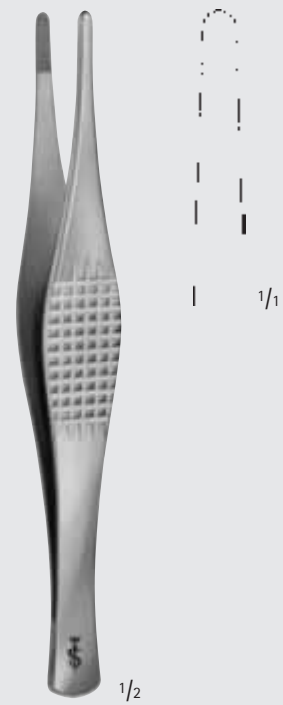

RAMSEY

**BD083R**

180 mm, 7"



DE BAKEY Zahnung

Toothing DE BAKEY

**AIRAUMATA®**

## Pinzetten – Dissecting- and Tissue Forceps

Ultra-Light-Pinzetten

Ultra-Light-Forceps

**BD**

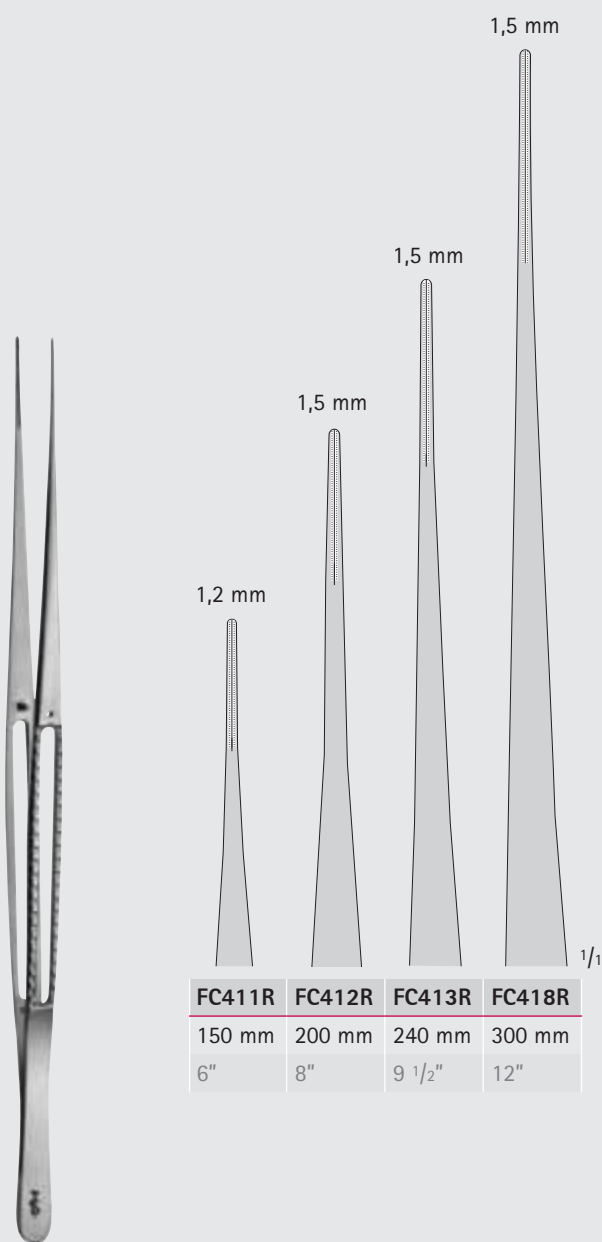

FC411R	FC412R	FC413R	FC418R
150 mm	200 mm	240 mm	300 mm
6"	8"	9 1/2"	12"

DE BAKEY

**FC411R-FC418R**

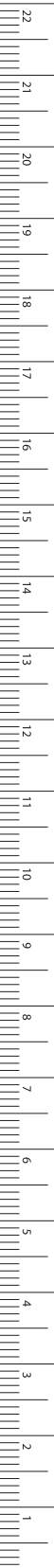

MILLIMETERS

# Pinzetten – Dissecting- and Tissue Forceps

Pinzetten  
Forceps

DE BAKEY Zahnung

ARAUMATA®

Toothing DE BAKEY

BD

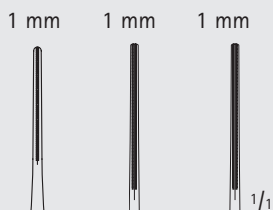

FB394R	FB395R	FB396R
150 mm	195 mm	240 mm
6"	7 3/4"	9 1/2"

DE BAKEY

FB394R-FB396R

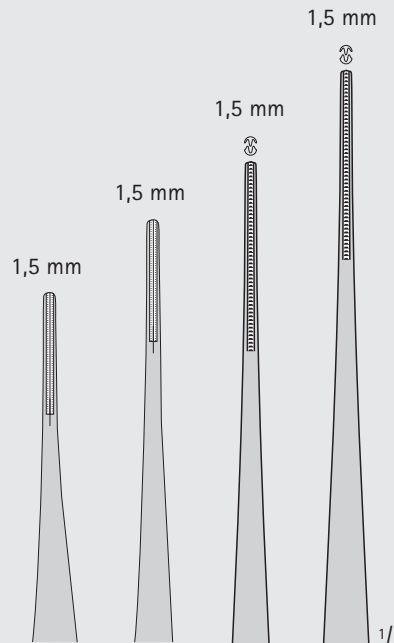

FB411R	FB412R	FB418R	FB419R
150 mm	200 mm	240 mm	300 mm
6"	8"	9 1/2"	12"

DE BAKEY

FB411R-FB419R

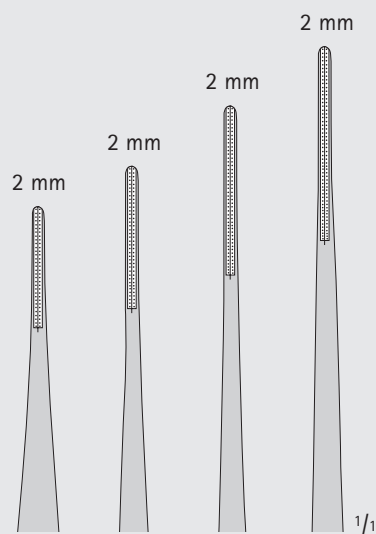

FB400R	FB402R	FB404R	FB405R
150 mm	200 mm	240 mm	300 mm
6"	8"	9 1/2"	12"

DE BAKEY

FB400R-FB405R

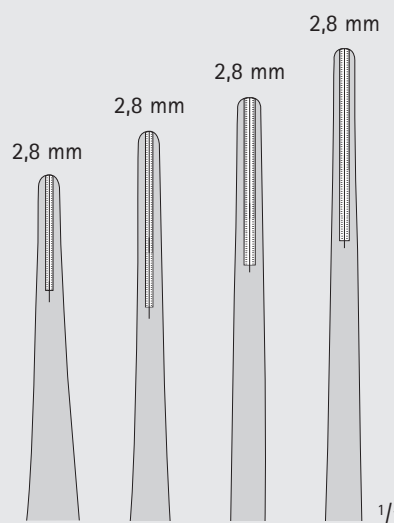

FB414R	FB415R	FB416R	FB417R
150 mm	200 mm	240 mm	300 mm
6"	8"	9 1/2"	12"

DE BAKEY

FB414R-FB417R



DE BAKEY Zahnung

Toothing DE BAKEY

**AIRAUMATA®**

## Pinzetten – Dissecting- and Tissue Forceps

Pinzetten  
Forceps

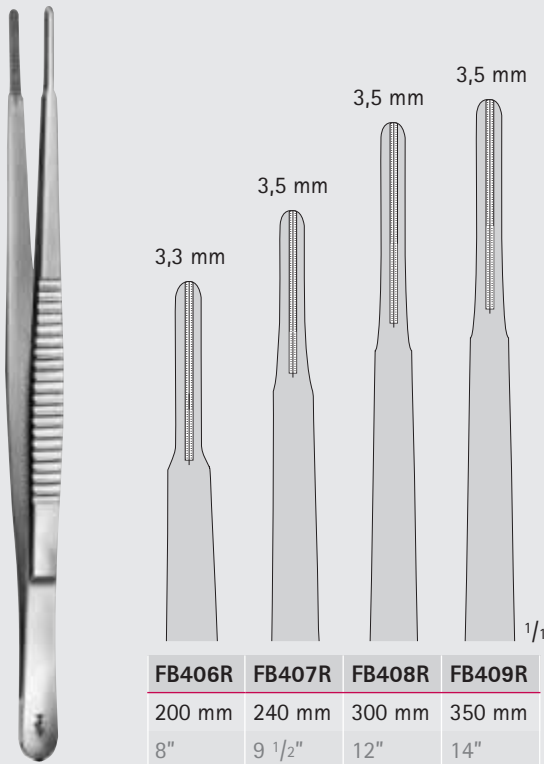

DE BAKEY

**FB406R-FB409R**

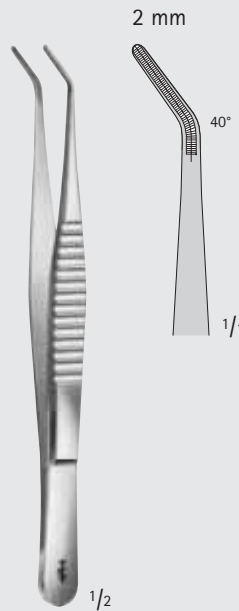

DE BAKEY

**FB401R**

150 mm, 6"

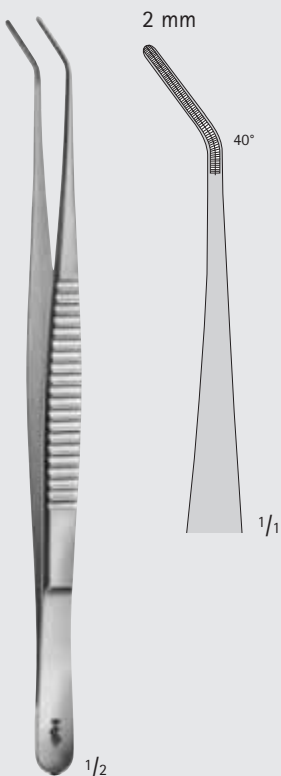

DE BAKEY

**FB403R**

200 mm, 8"

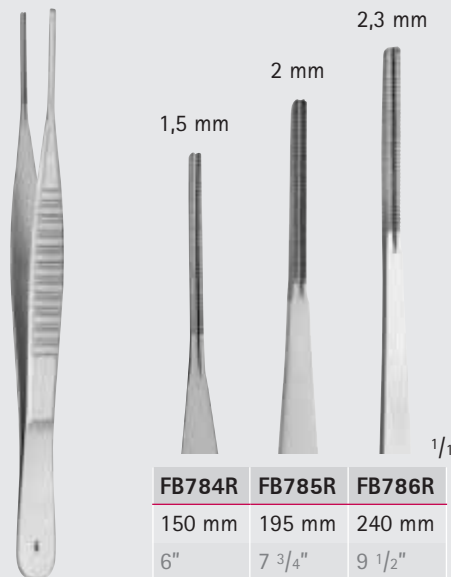

COOLEY

**FB784R-FB786R**

**BD**

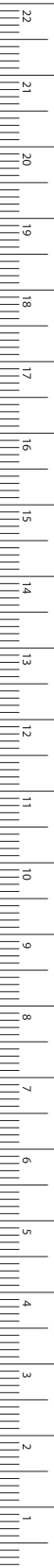

MILLIMETERS

## Pinzetten – Dissecting- and Tissue Forceps

DUROGRIP® Atraumatische Pinzetten

DUROGRIP® Non-traumatic Dissecting Forceps

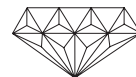

BD

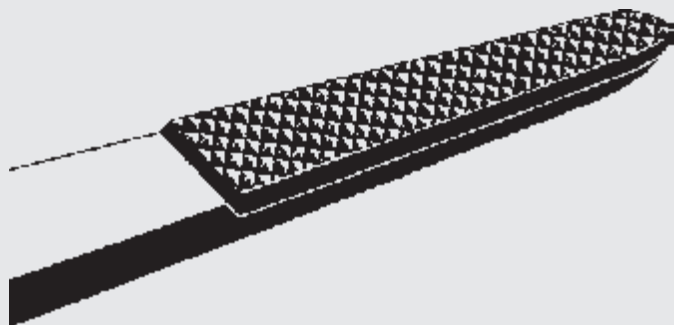

- Fein strukturiertes und präzise gearbeitetes Haftprofil
- sicheres und zugleich schonendes Fassen
- universell verwendbar
- unverwüstlich im Gebrauch
- Precisely worked out fine structure of carbide inserts
- thus firm and non-traumatic gripping of tissue
- universal in use
- long working life



DUROGRIP®-Pinzetten mit Hartmetall-Plättchen

**Kennzeichnung: vergoldete Feder**

DUROGRIP®-Dissecting Forceps with carbide inserts

Identification: gold-plated end

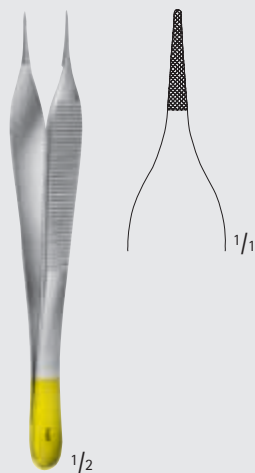

ADSON

**BD151R**

120 mm, 4 3/4"



BD154R	BD156R
145 mm	180 mm
5 3/4"	7"

**BD154R-BD156R**

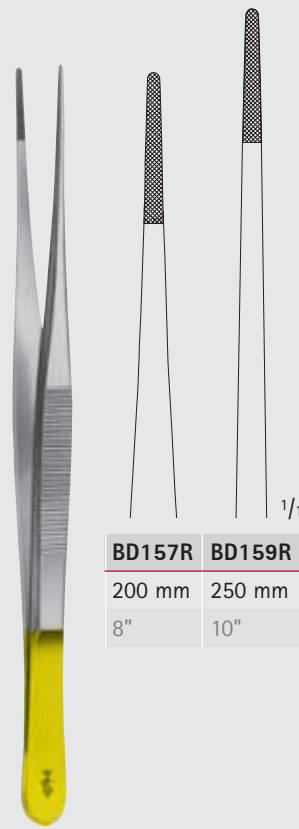

BD157R	BD159R
200 mm	250 mm
8"	10"

**BD157R-BD159R**



**BD158R**

230 mm, 9"

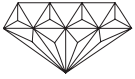

# Pinzetten – Dissecting- and Tissue Forceps

DUROGRIP® Pinzetten

DUROGRIP® Dissecting Forceps

BD



Besonders sicheres und schonendes Fassen des Fadens durch kissenförmige Maulform  
Cushion shaped tip ensures a safe and gentle grasping of the thread

1/2

**BD180R**

Nahtpinzette  
Suture forceps  
200 mm, 8"



1/1

1/2

**FERRIS-SMITH**

**BD181R**

175 mm, 7"

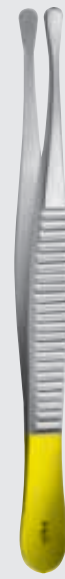

1/1

BD171R	BD173R
150 mm	230 mm
6"	9"

**WANGENSTEEN**

**BD171R-BD173R**



MILLIMETERS

# Pinzetten – Dissecting- and Tissue Forceps

DUROGRIP® Pinzetten

DUROGRIP® Dissecting Forceps

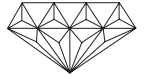

BD

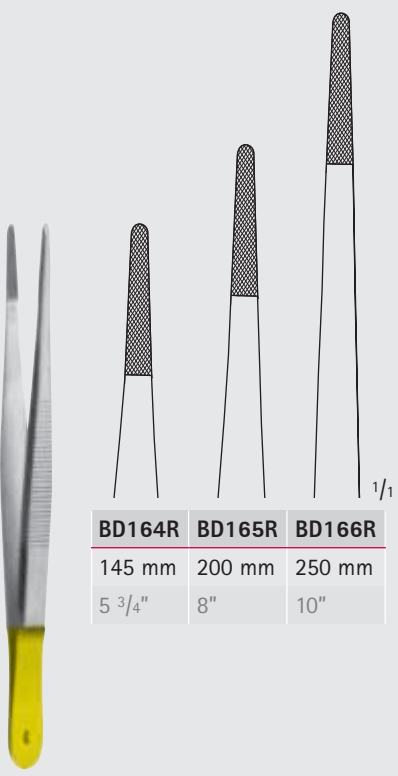

BD164R	BD165R	BD166R
145 mm	200 mm	250 mm
5 3/4"	8"	10"

**STANDARD**  
**BD164R-BD166R**

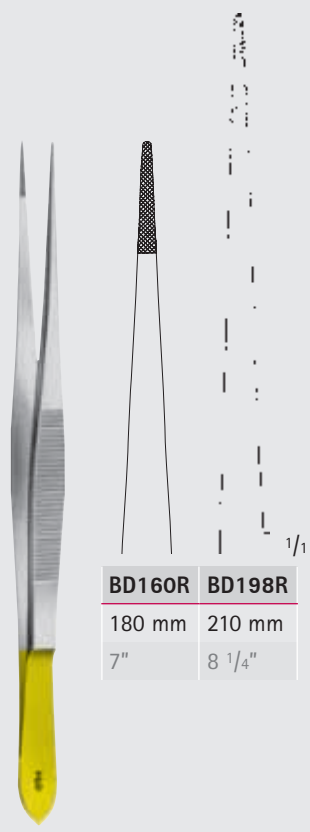

BD160R	BD198R
180 mm	210 mm
7"	8 1/4"

**CUSHING**  
**BD160R-BD198R**  
mit Schaber  
with scraper end

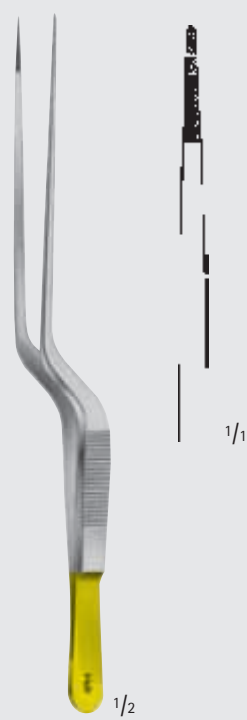

**GRUENWALD**  
**BD168R**  
185 mm, 7 1/4"





## Pinzetten – Dissecting- and Tissue Forceps

Pinzetten, bajonettförmig gebogen  
Forceps, Bayonet-Shaped

BD

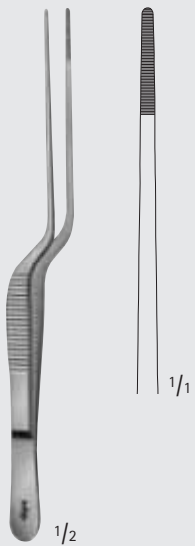

LUCAE

**BD878R**

140 mm, 5 1/2"

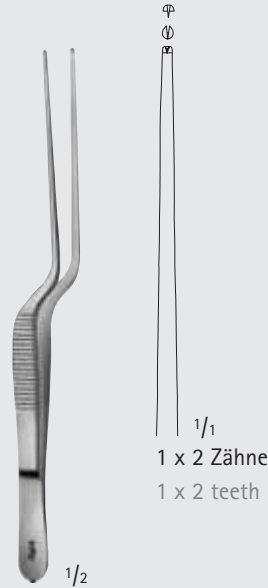

LUCAE

**BD879R**

140 mm, 5 1/2"



COTTLE

**OL011R**

Fixierpinzette  
Forceps  
140 mm, 5 1/2"

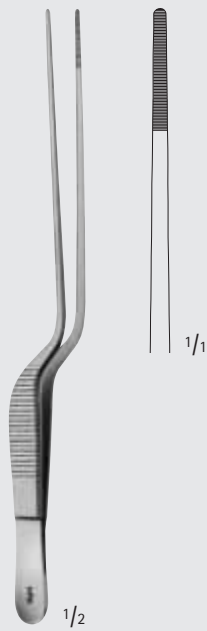

JANSEN

**BD880R**

160 mm, 6 1/4"

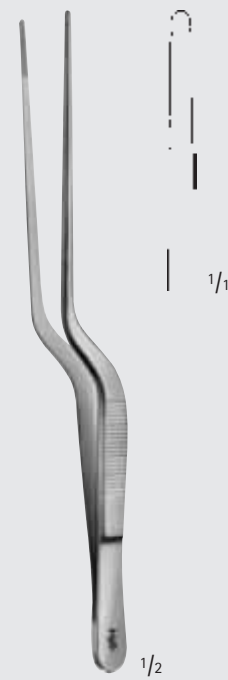

ADSON

**BD870R**

175 mm, 7"



MILLIMETERS

## Pinzetten – Dissecting- and Tissue Forceps

Pinzetten, bajonettförmig gebogen

Forceps, Bayonet-Shaped

BD

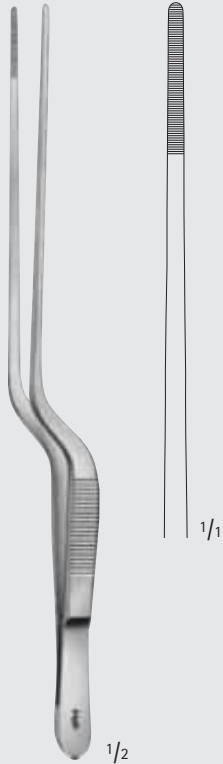

GRUENWALD

**BD883R**

200 mm, 8"

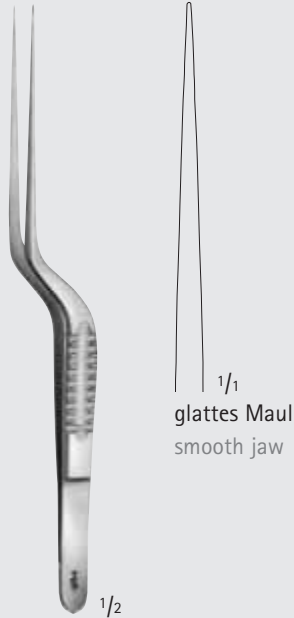

glattes Maul  
smooth jaw

**BD887R**

160 mm, 6 1/4"

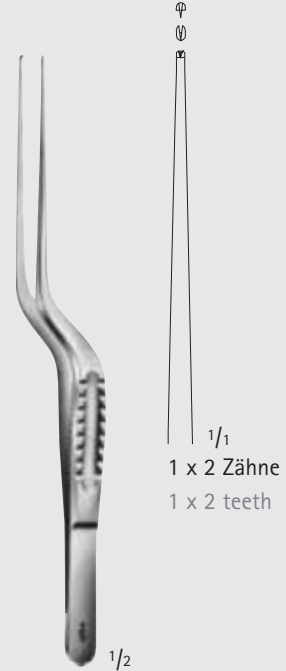

1 x 2 Zähne  
1 x 2 teeth

**BD888R**

160 mm, 6 1/4"

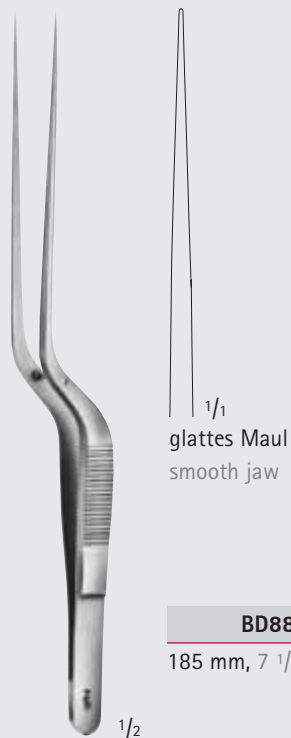

glattes Maul  
smooth jaw

**BD885R**

185 mm, 7 1/4"

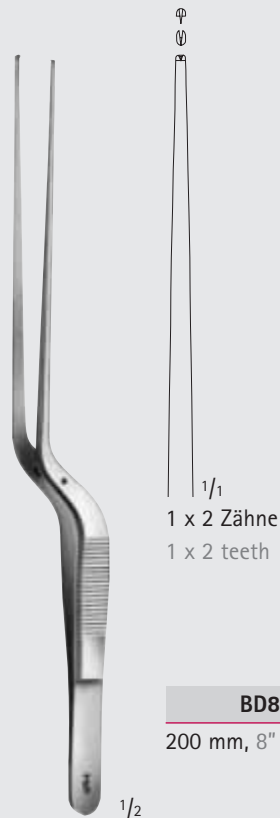

1 x 2 Zähne  
1 x 2 teeth

**BD886R**

200 mm, 8"



## Pinzetten – Dissecting- and Tissue Forceps

Pinzetten, kniegebogen  
Forceps, Angular

BD



TROELTSCH

**BD900R**

100 mm, 4"

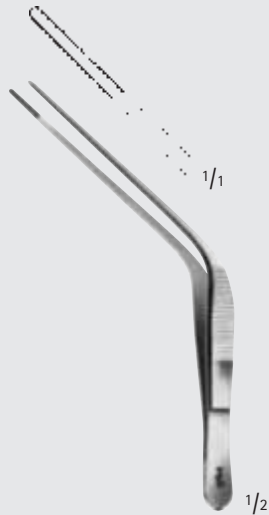

TROELTSCH

**BD902R**

115 mm, 4 1/2"

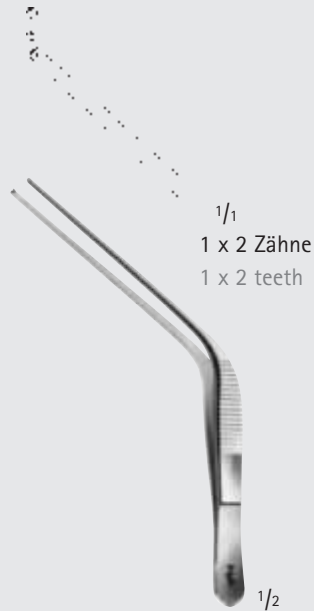

TROELTSCH

**BD903R**

115 mm, 4 1/2"

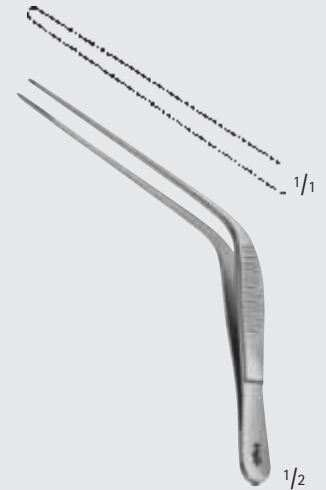

WILDE

**BD904R**

115 mm, 4 1/2"

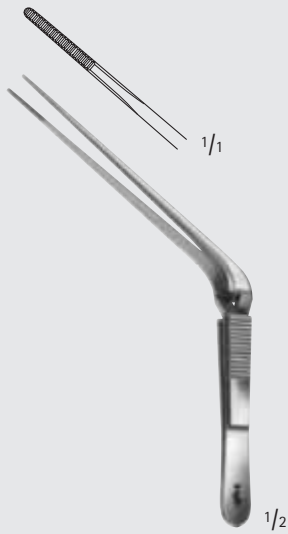

TROELTSCH

**BD905R**

selbstschließend  
cross action  
120 mm, 4 3/4"

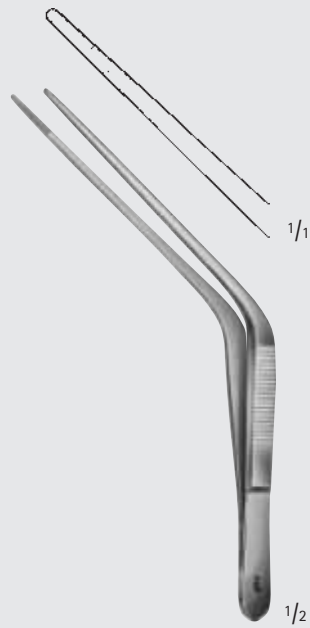

TROELTSCH

**BD910R**

140 mm, 5 1/2"

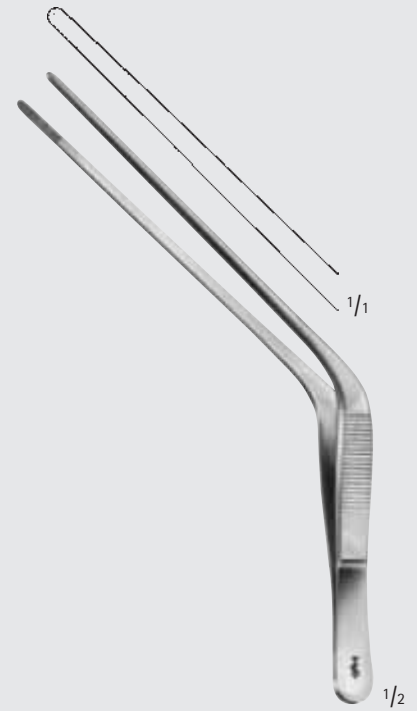

TROELTSCH

**BD911R**

170 mm, 6 3/4"

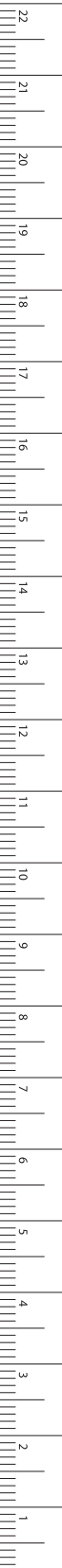

MILLIMETERS

## Pinzetten – Dissecting- and Tissue Forceps

Feine chirurgische Pinzetten

Delicate Tissue Forceps

BD

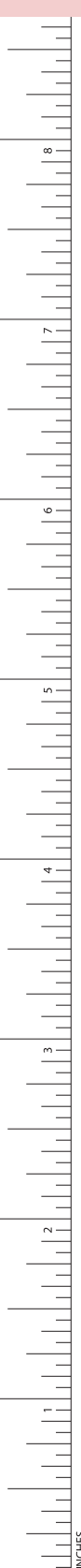

BISHOP-HARMON

**OC051R**

Augenpinzette

Eye forceps

85 mm, 3 1/2"



ST. MARTIN

**OC091R**

Augenpinzette

Eye forceps

80 mm, 3 1/8"

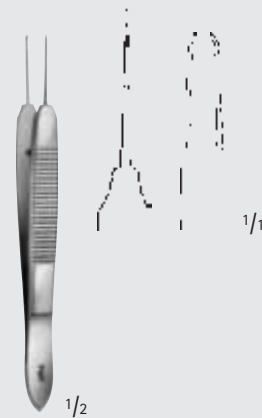

CASTROVIEJO

**OC094R**

Augenpinzette

Eye forceps

100 mm, 4"

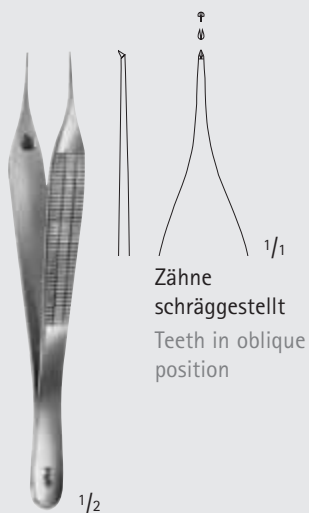

Zähne  
schräggestellt  
Teeth in oblique  
position

MICRO-ADSON-BIEMER

**BD509R**

120 mm, 4 3/4"

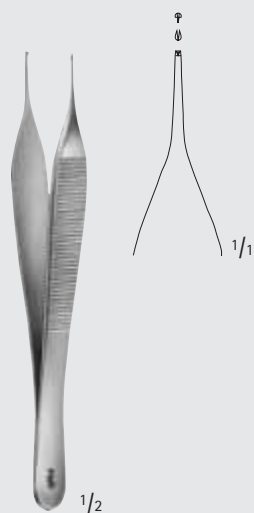

MICRO-ADSON

**BD510R**

120 mm, 4 3/4"

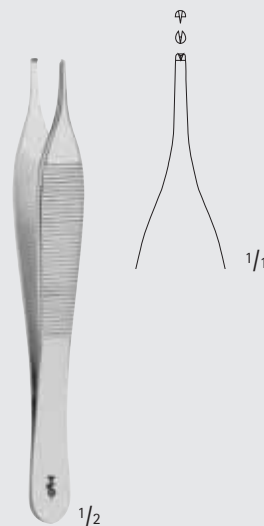

ADSON

**BD511R**

120 mm, 4 3/4"

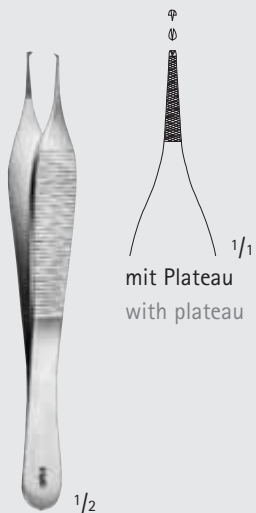

mit Plateau  
with plateau

ADSON

**BD512R**

120 mm, 4 3/4"



# Pinzetten – Dissecting- and Tissue Forceps

Feine chirurgische Pinzetten

Delicate Tissue Forceps

**BD**

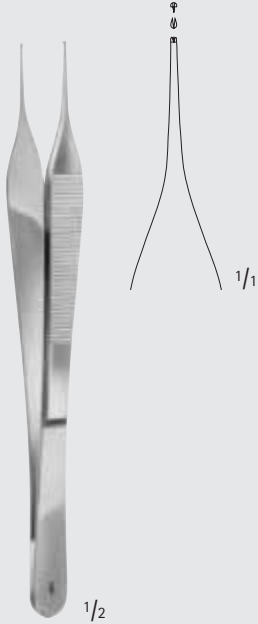

MICRO-ADSON

**BD520R**

150 mm, 6"



ADSON

**BD522R**

180 mm, 7"

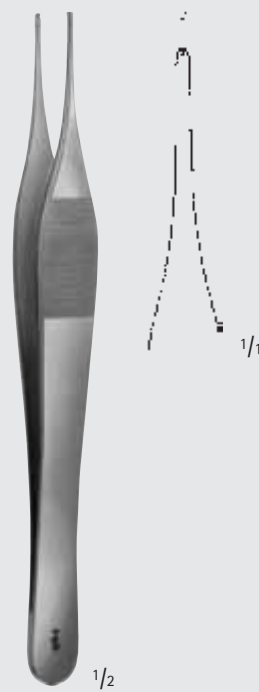

JEFFERSON

**BD523R**

180 mm, 7"

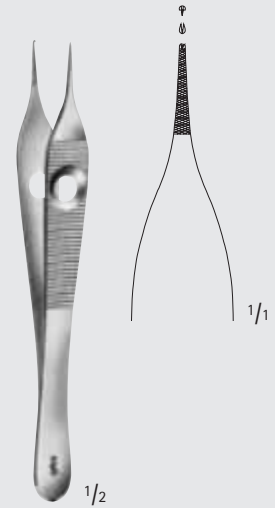

ADSON

**BD508R**

120 mm, 4 3/4"



ADSON

**BD513R**

120 mm, 4 3/4"

mit Plateau  
with plateau

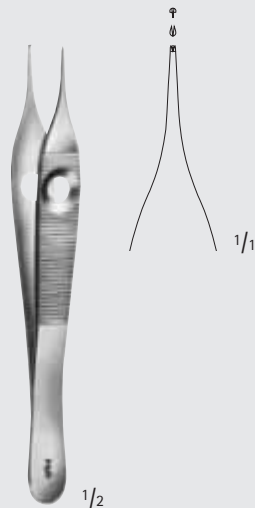

ADSON

**BD506R**

120 mm, 4 3/4"

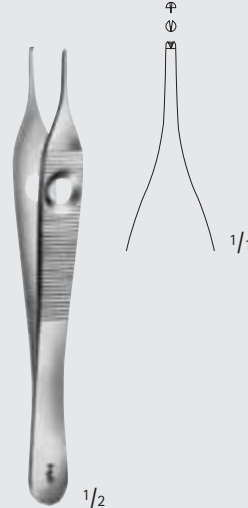

ADSON

**BD507R**

120 mm, 4 3/4"

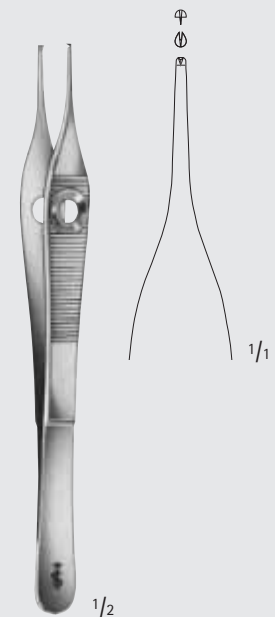

ADSON

**BD521R**

150 mm, 6"



MILLIMETERS

# Pinzetten – Dissecting- and Tissue Forceps

Chirurgische Pinzetten

Tissue Forceps

BD

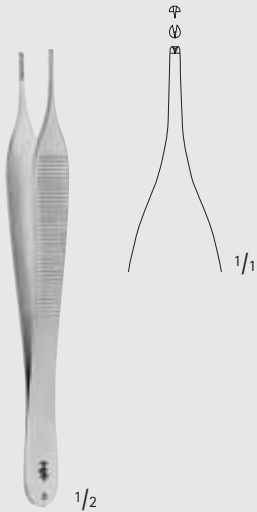

HUDSON

**MB291R**

125 mm, 4 7/8"

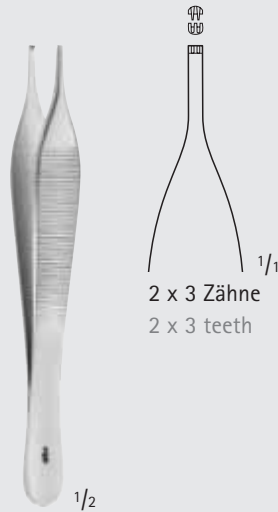

ADSON

**MB454R**

120 mm, 4 3/4"

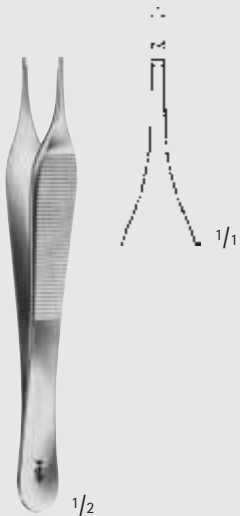

ADSON-BROWN

**BD700R**

Hautpinzette, scharf

Tissue forceps, sharp

120 mm, 4 3/4"

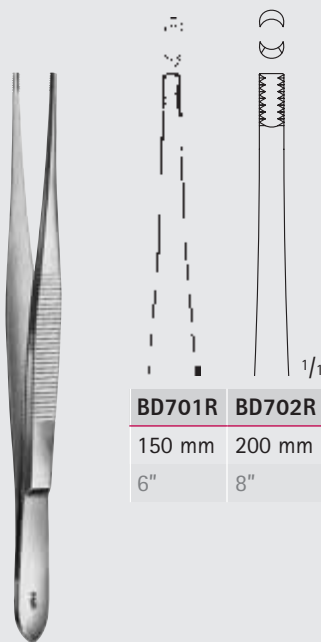

BROWN

**BD701R-BD702R**



GRAEFFE

**OC100R**

110 mm, 4 1/2"



# Pinzetten – Dissecting- and Tissue Forceps

Feine chirurgische Pinzetten

Delicate Tissue Forceps

BD

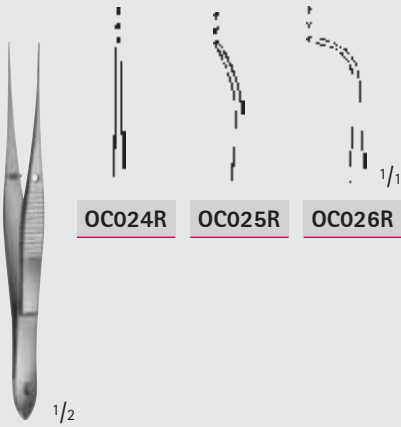

**OC024R**   **OC025R**   **OC026R**

**OC024R-OC026R**

sehr fein  
very delicate  
100 mm, 4"



**BD500R**

100 mm, 4"

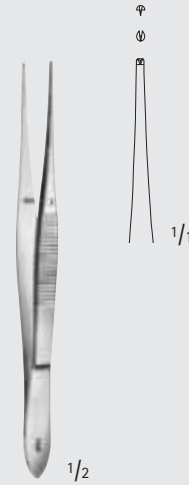

**BD501R**

110 mm, 4 3/8"

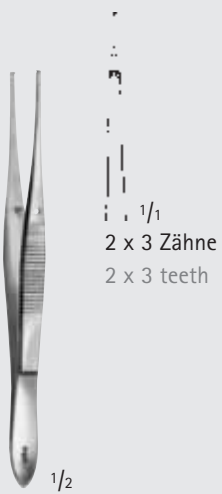

**BD502R**

110 mm, 4 3/8"

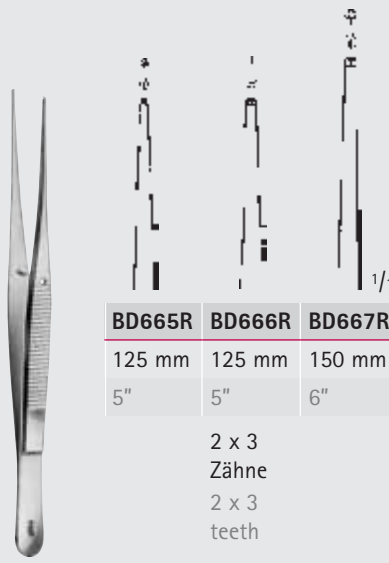

BD665R	BD666R	BD667R
125 mm	125 mm	150 mm
5"	5"	6"

2 x 3  
Zähne  
2 x 3  
teeth

SEMKEN

**BD665R-BD667R**

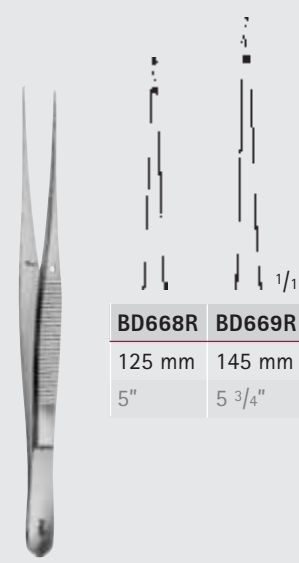

BD668R	BD669R
125 mm	145 mm
5"	5 3/4"

SEMKEN

**BD668R-BD669R**



MILLIMETERS

# Pinzetten – Dissecting- and Tissue Forceps

Feine chirurgische Pinzetten

Delicate Tissue Forceps

BD



GILLIES

**BD660R**

155 mm, 6"



MC INDOE

**BD661R**

150 mm, 6"

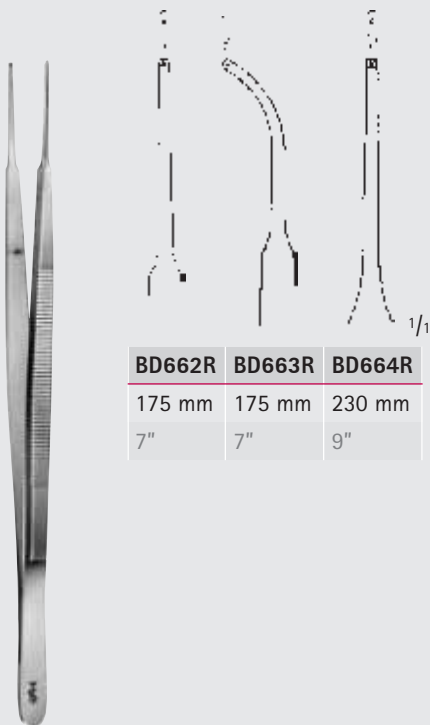

GERALD

**BD662R-BD664R**

BD662R	BD663R	BD664R
175 mm	175 mm	230 mm
7"	7"	9"

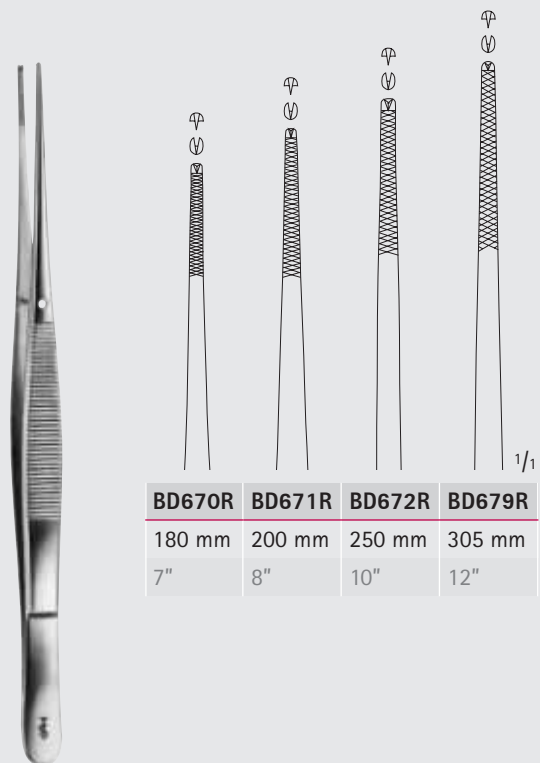

WAUGH

**BD670R-BD679R**

BD670R	BD671R	BD672R	BD679R
180 mm	200 mm	250 mm	305 mm
7"	8"	10"	12"





# Pinzetten – Dissecting- and Tissue Forceps

Chirurgische Pinzetten  
Tissue Forceps

BD



BROPHY

**BD678R**

200 mm, 8"



**BD651R**

200 mm, 8"



CUSHING

**MD463**

180 mm, 7"



MILLIMETERS

# Pinzetten – Dissecting- and Tissue Forceps

Chirurgische Pinzetten

Tissue Forceps

BD

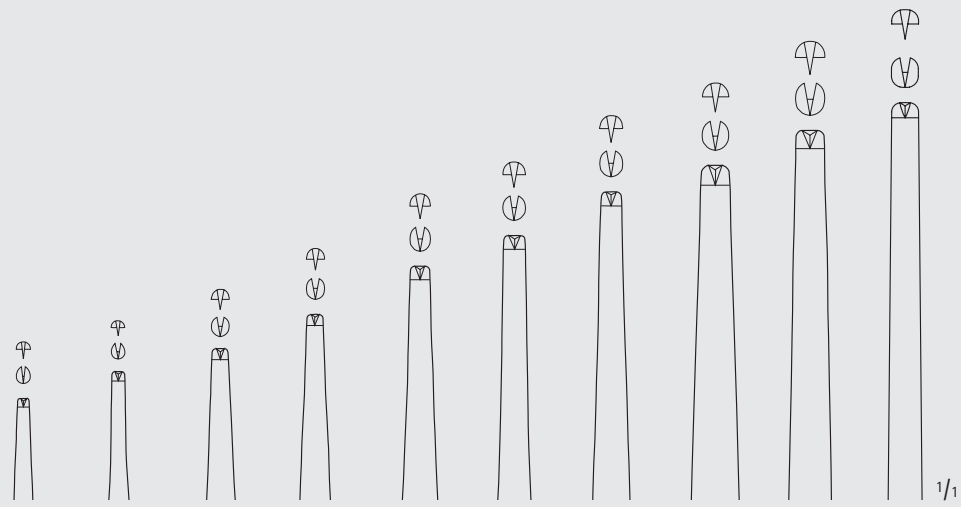

BD552R	BD553R	BD555R	BD557R	BD559R	BD560R	BD561R	BD562R	BD563R	BD564R
105 mm	115 mm	130 mm	145 mm	160 mm	180 mm	200 mm	250 mm	300 mm	350 mm
4 1/8"	4 1/2"	5 1/8"	5 3/4"	6 1/4"	7"	8"	10"	12"	14"

**BD552R-BD564R**  
Standard-Modelle  
Standard patterns

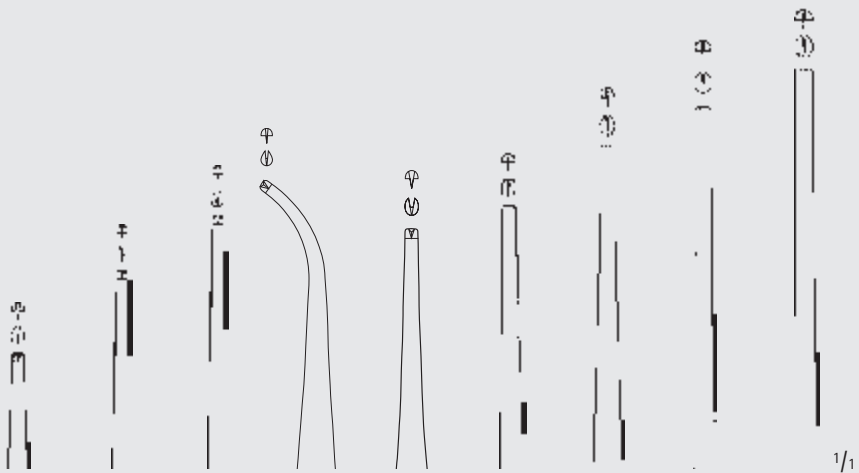

BD533R	BD535R	BD537R	BD527R	BD539R	BD540R	BD541R	BD542R	BD543R
115 mm	130 mm	145 mm	145 mm	160 mm	180 mm	200 mm	250 mm	300 mm
4 1/2"	5 1/8"	5 3/4"	5 3/4"	6 1/4"	7"	8"	10"	12"

**BD527R-BD543R**  
mittelbreit  
medium



# Pinzetten – Dissecting- and Tissue Forceps

Chirurgische Pinzetten  
Tissue Forceps

**BD**



BD547R	BD549R
145 mm	160 mm
5 3/4"	6 1/4"

**BD547R-BD549R**

kräftiger als BD537R und BD539R  
aber feiner als BD557R und BD559R  
stronger as BD537R and BD539R  
but finer than BD557R and BD559R

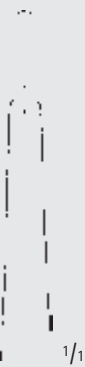

1/2

**BD600R**

kräftiges Modell  
heavy pattern  
145 mm, 5 3/4"



BD575R	BD577R	BD579R	BD580R	BD581R
130 mm	145 mm	160 mm	180 mm	200 mm
5 1/8"	5 3/4"	6 1/4"	7"	8"

**BD575R-BD581R**

2 x 3 Zähne  
2 x 3 teeth



MILLIMETERS

# Pinzetten – Dissecting- and Tissue Forceps

Chirurgische Pinzetten

Tissue Forceps

BD

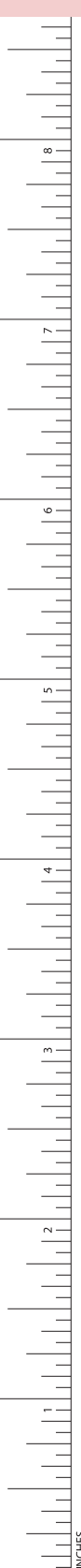

BD587R	BD589R	BD591R
145 mm	160 mm	200 mm
5 3/4"	6 1/4"	8"

1/1

**BD587R-BD591R**

3 x 4 Zähne  
3 x 4 teeth

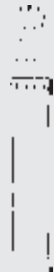

1/1  
4 x 5 Zähne  
4 x 5 teeth

1/2

**BD597R**

145 mm, 5 3/4"



1/1  
4 x 5 Zähne  
4 x 5 teeth

1/2

**OFFICER**

**BD598R**

150 mm, 6"

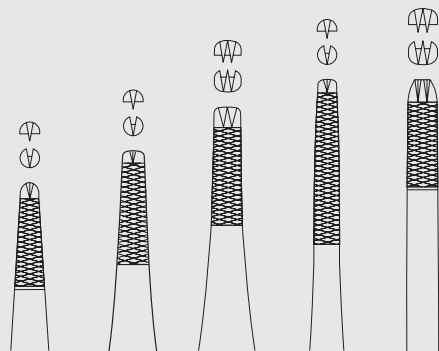

1/1

BD602R	BD603R	BD604R	BD606R	BD607R
125 mm	145 mm	145 mm	175 mm	175 mm
5"	5 3/4"	5 3/4"	7"	7"
		2 x 3 Zähne 2 x 3 teeth		2 x 3 Zähne 2 x 3 teeth

**LANE**

**BD602R-BD607R**



# Pinzetten – Dissecting- and Tissue Forceps

Chirurgische Pinzetten  
Tissue Forceps

**BD**



BD608R	BD609R
125 mm	150 mm
8"	6"

1/1

TREVES

**BD608R-BD609R**



1/1

1/2

BONNEY

**BD693R**

175 mm, 7"



1/1

1/2

JACKSON-BURROWS

**BD704R**

140 mm, 5 1/2"

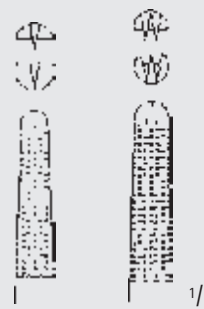

1/1

**BD610R**

**BD611R**

3 x 4  
Zähne  
3 x 4  
teeth

1/2

RAMSEY

**BD610R-BD611R**

180 mm, 7"



MILLIMETERS

# Pinzetten – Dissecting- and Tissue Forceps

Chirurgische Pinzetten

Tissue Forceps

BD



1/1

1/2

CHARNLEY

**BD705R**

180 mm, 7"



1/1

BD690R	BD692R
150 mm	200 mm
6"	8"

STRASSBURGER MODELL

**BD690R-BD692R**

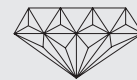

1/1

1/2

**BD185R**

Nahtpinzette  
Suture forceps  
300 mm, 12"



# Pinzetten – Dissecting- and Tissue Forceps

## Chirurgische Pinzetten

### Tissue Forceps

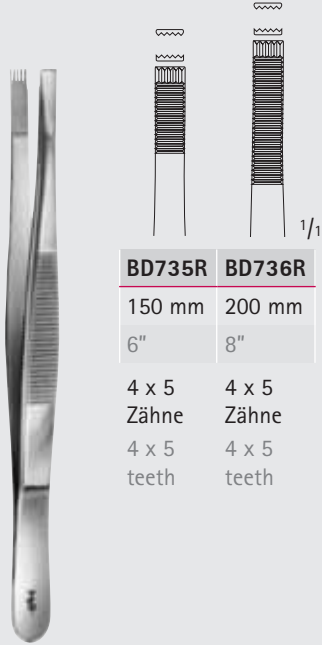

BD735R	BD736R
150 mm	200 mm
6"	8"
4 x 5 Zähne	4 x 5 Zähne
4 x 5 teeth	4 x 5 teeth

ADLERKREUTZ

**BD735R-BD736R**

Gefäß- und Tumorpinzette  
Vascular- and tumor forceps

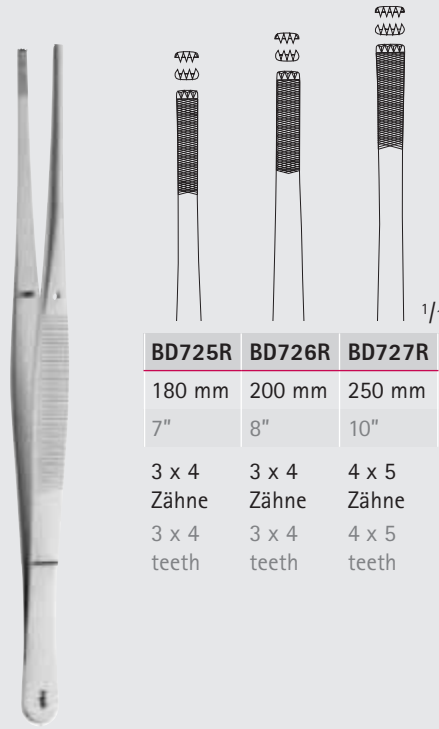

BD725R	BD726R	BD727R
180 mm	200 mm	250 mm
7"	8"	10"
3 x 4 Zähne	3 x 4 Zähne	4 x 5 Zähne
3 x 4 teeth	3 x 4 teeth	4 x 5 teeth

STILLE-BARRAYA

**BD725R-BD727R**

Gefäß- und Tumorpinzetten  
Vascular- and tumor forceps



RUSS. MODELL

**BD755R**

150 mm, 6"



RUSS. MODELL

**BD760R**

200 mm, 8"



SELMAN

**BD750R**

155 mm, 6"

BD

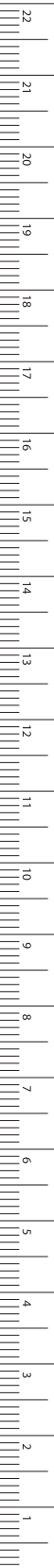

MILLIMETERS

## Pinzetten – Dissecting- and Tissue Forceps

Lungenfasspinzetten, Darmpinzetten

Lung Grasping Dissecting Forceps, Intestinal Forceps

BD

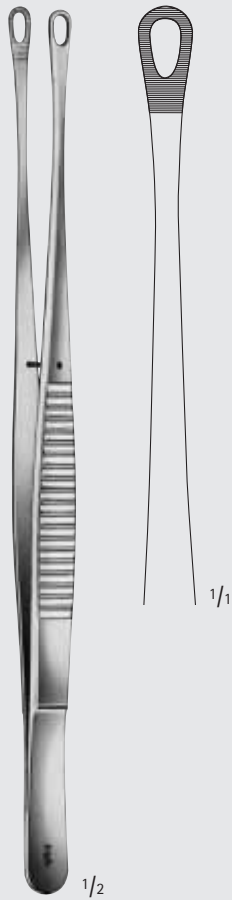

TUTTLE

**BD801R**

Lungenfasspinzette  
Lung grasping forceps  
230 mm, 9"

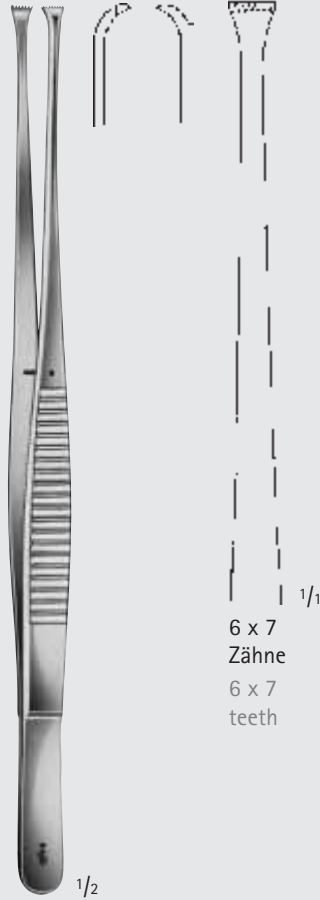

NELSON

**BD802R**

Lungenfasspinzette  
Lung grasping forceps  
230 mm, 9"



DUVAL

**BD820R**

Darmpinzette  
Intestinal forceps  
140 mm, 5 1/2"

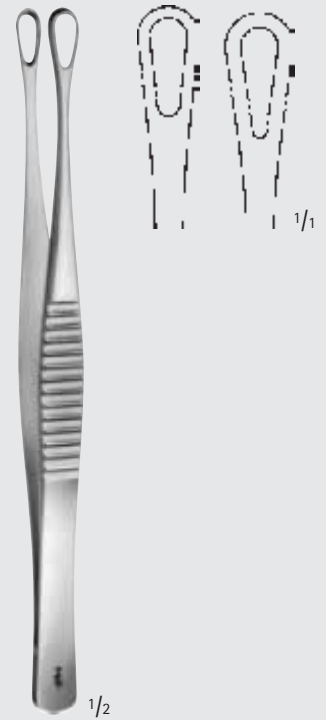

DENIS- BROWNE

**EA027R**

Darmpinzette  
Intestinal forceps  
190 mm, 7 1/2"





## Pinzetten – Dissecting- and Tissue Forceps

Splitterpinzetten, Splitterzangen  
Splinter Forceps



**BD952R**

Splitterpinzette  
Splinter forceps  
80 mm, 3 1/8"

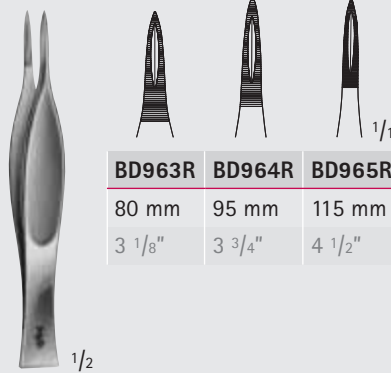

BD963R	BD964R	BD965R
80 mm	95 mm	115 mm
3 1/8"	3 3/4"	4 1/2"

**FEILCHENFELD**

**BD963R-BD965R**

Splitterpinzetten  
Splinter forceps



**HUNTER**

**BD980R**

Splitterpinzette  
Splinter forceps  
105 mm, 4 1/8"

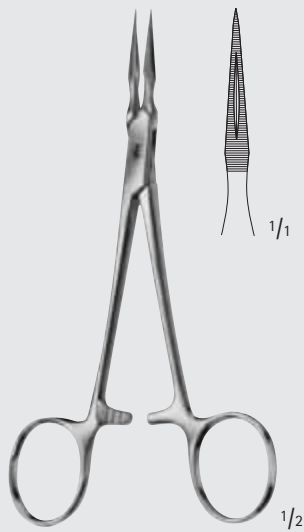

**STIEGLITZ**

**BD992R**

Splitterzange  
Splinter forceps  
140 mm, 5 1/2"

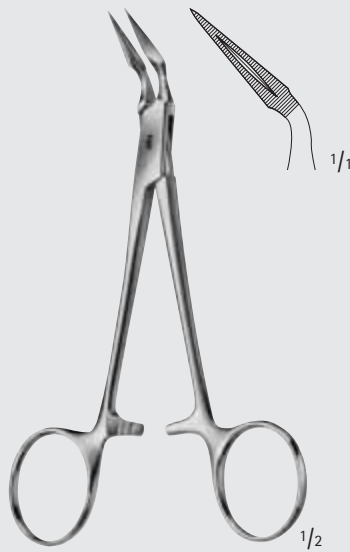

**STIEGLITZ**

**BD993R**

Splitterzange  
Splinter forceps  
140 mm, 5 1/2"

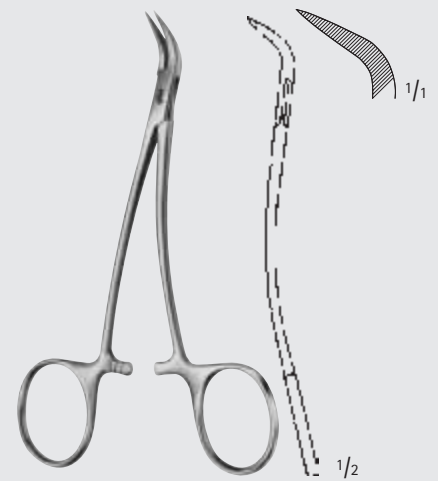

**PEET**

**BD995R**

Splitterzange  
Splinter forceps  
120 mm, 4 3/4"

**BD**

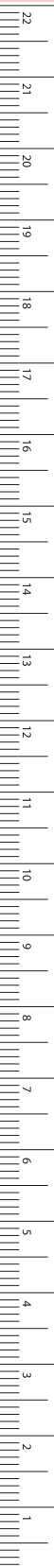

MILLIMETERS



INCHES

BF



**Korn- und Tupferzangen,  
Waschzangen, Tuchklemmen**  
Sponge- and Dressing-Forceps,  
Washing Forceps, Towel Clamps

## Korn- und Tupferzangen – Sponge- and Dressing Forceps

Korn- und Tupferzangen  
Sponge- and Dressing Forceps

BF

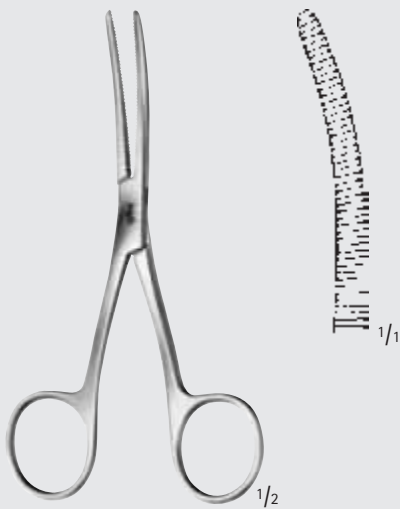

BRYANT

**BF003R**

130 mm, 5 1/8"



LISTER

**BF004R-BF008R**

Sinusklemmen  
Sinus forceps

BF004R	BF006R	BF008R
130 mm	160 mm	175 mm
5 1/8"	6 1/4"	7"

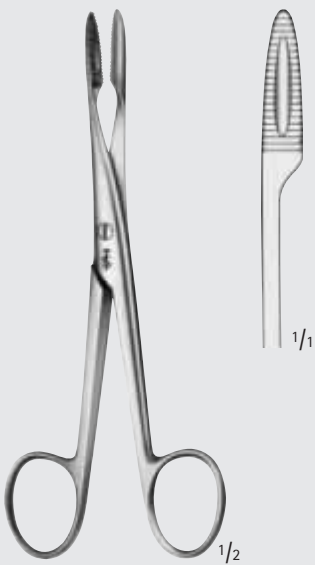

**BF010R**

ohne Sperre  
without ratchet  
145 mm, 5 3/4"

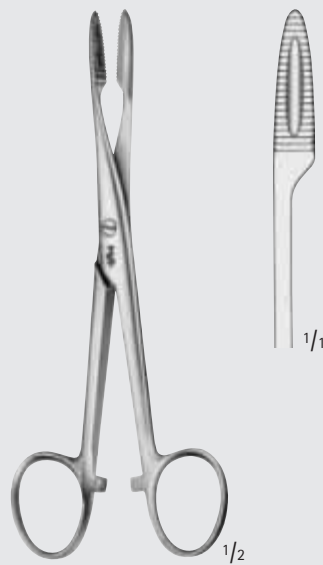

**BF016R**

mit Sperre  
with ratchet  
145 mm, 5 3/4"

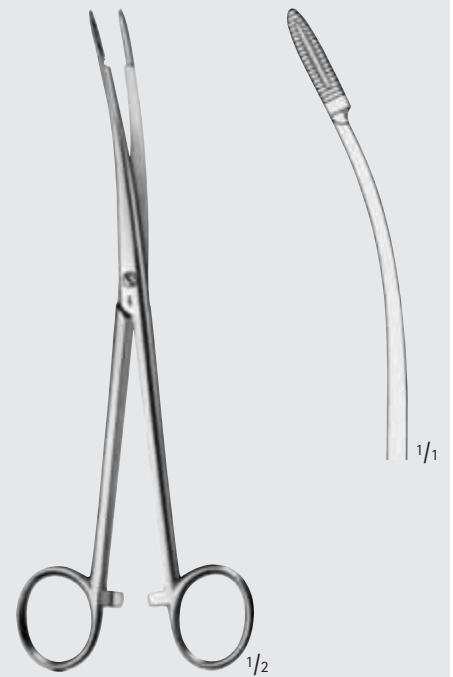

**BF021R**

175 mm, 7"

## Korn- und Tupferzangen – Sponge- and Dressing Forceps

Korn- und Tupferzangen  
Sponge- and Dressing Forceps

**BF**

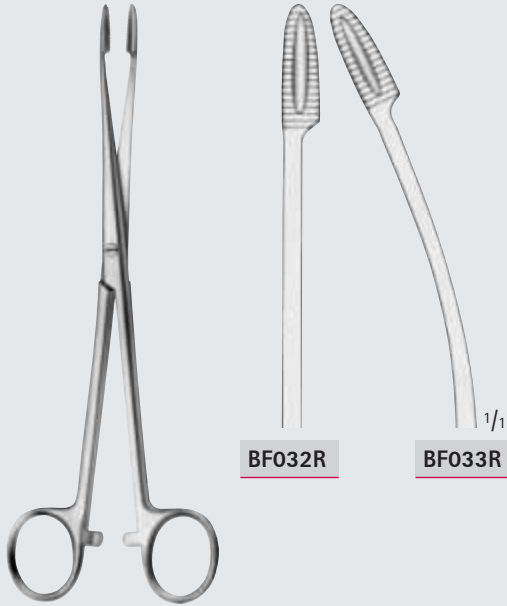

**BF032R**

**BF033R**

GROSS

**BF032R-BF033R**

mit Sperre  
with ratchet  
180 mm, 7"

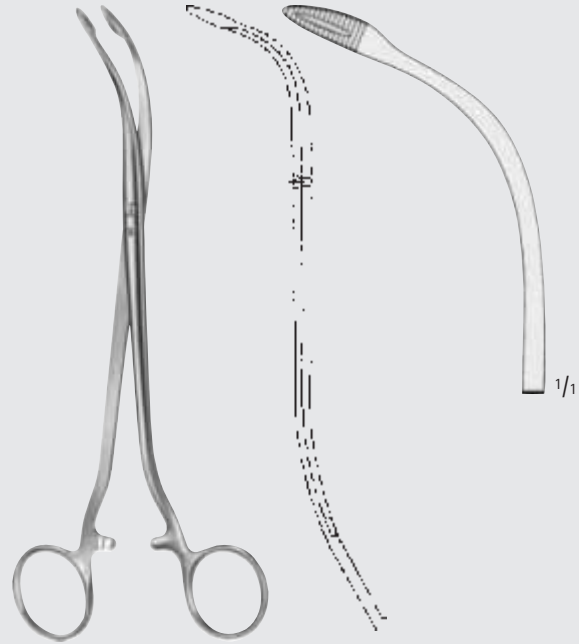

DUPLAY

**OM485R**

190 mm, 7 1/2"

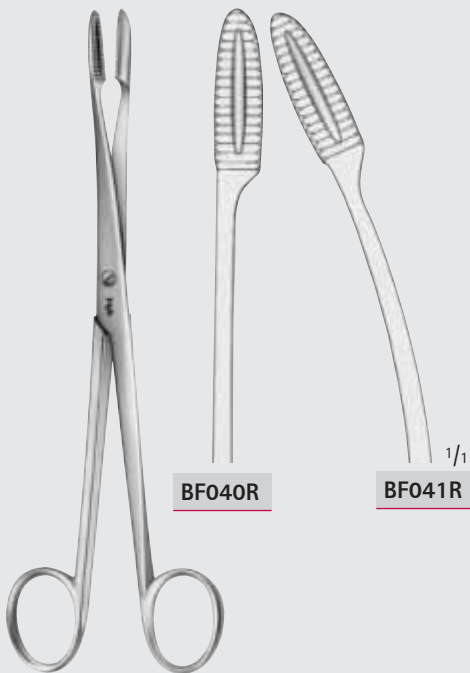

**BF040R**

**BF041R**

GROSS

**BF040R-BF041R**

ohne Sperre  
without ratchet  
200 mm, 8"

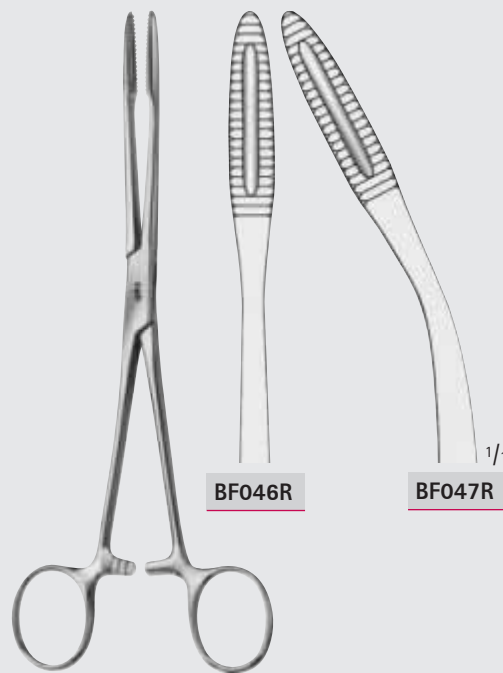

**BF046R**

**BF047R**

GROSS

**BF046R-BF047R**

200 mm, 8"

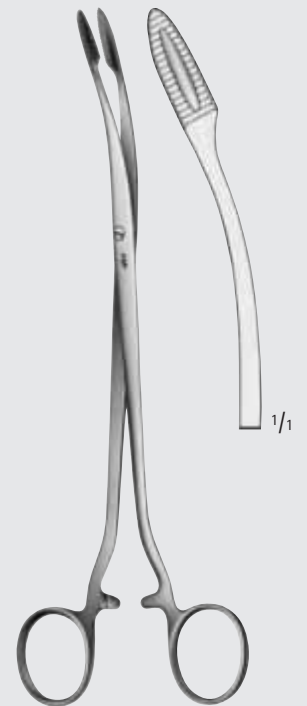

DUPLAY

**BF027R**

210 mm, 8 1/4"

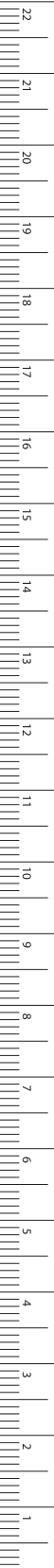

MILLIMETERS

## Korn- und Tupferzangen – Sponge- and Dressing Forceps

Korn-, Tupfer- und Waschzangen  
Sponge- and Dressing Forceps

BF



AESCULAP

**BF060R-BF061R**

220 mm, 8 3/4"

**BF060R**

**BF061R**



ULRICH-AESCULAP

**BF062R-BF065R**

**BF062R**

265 mm

10 1/2"

**BF063R**

265 mm

10 1/2"

**BF065R**

350 mm

14"

## Korn- und Tupferzangen – Sponge- and Dressing Forceps

Korn- und Tupferzangen  
Sponge- and Dressing Forceps

**BF**

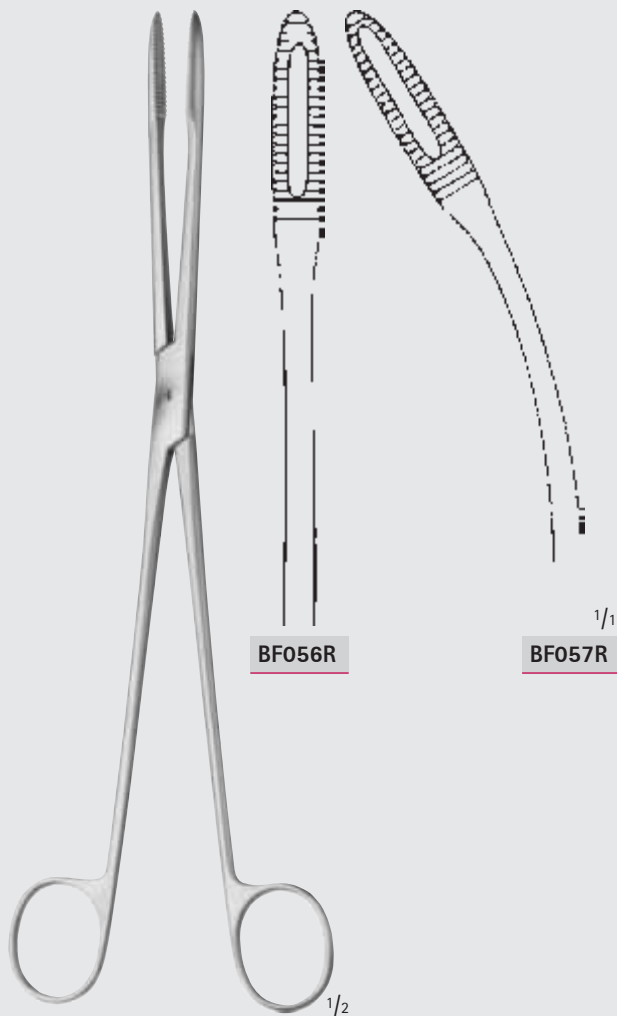

**BF056R**

**BF057R**

1/1

1/2

MAIER

**BF056R-BF057R**

ohne Sperre  
without ratchet  
265 mm, 10 1/2"

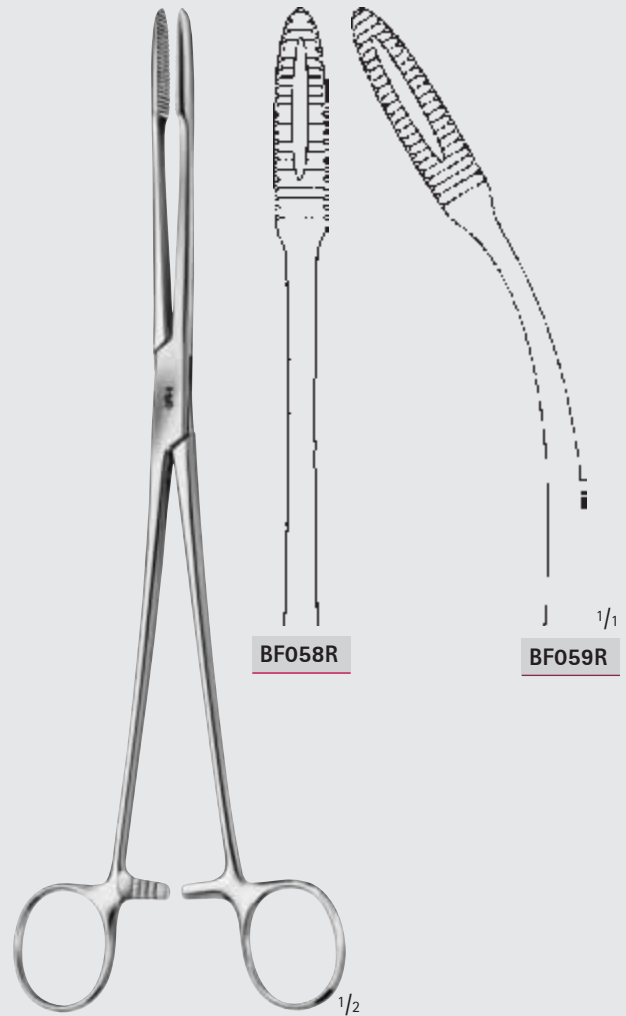

**BF058R**

**BF059R**

1/1

1/2

MAIER

**BF058R-BF059R**

mit Sperre  
with ratchet  
265 mm, 10 1/2"



## Korn- und Tupferzangen – Sponge- and Dressing Forceps

Korn- und Tupferzangen  
Sponge- and Dressing Forceps

BF



SIMS-MAIER

**BF076R-BF078R**

**BF076R**  
280 mm  
11"

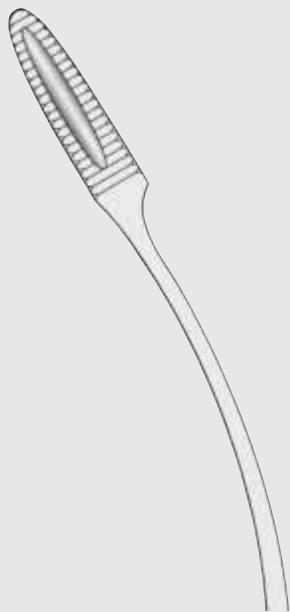

**BF077R**  
280 mm  
11"

**BF078R**  
350 mm  
14"



<sup>1/1</sup>

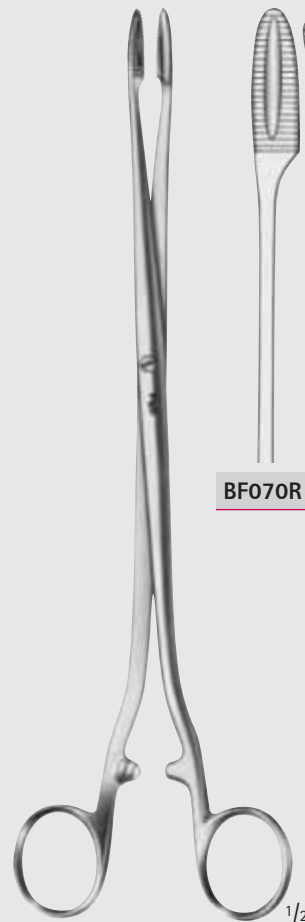

**BF070R-BF071R**

240 mm, 9 1/2"

**BF070R**



**BF071R**

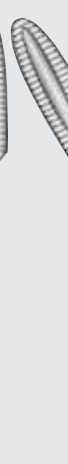

<sup>1/1</sup>

<sup>1/2</sup>



## Korn- und Tupferzangen – Sponge- and Dressing Forceps

Korn- und Tupferzangen  
Sponge- and Dressing Forceps

**BF**



**BF091R**

COLLIN

**BF091R**

240 mm, 9 1/2"



**BF092R**

CHERON

**BF092R**

Griffe seitwärts abgewinkelt  
Handles angled to side  
240 mm, 9 1/2"

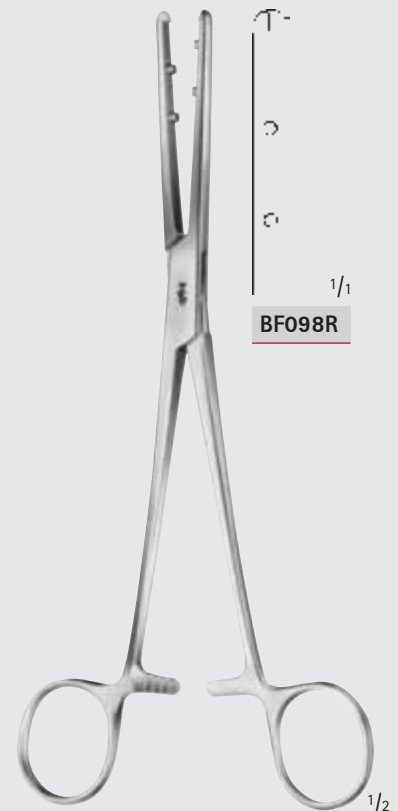

**BF098R**

EMMET

**BF098R**

210 mm, 8 1/4"



## Korn- und Tupferzangen – Sponge- and Dressing Forceps

Tupfer-, Schwamm-, Organ- und Gewebefasszangen

Dressing-, Sponge Holding-, Organ- and Tissue Grasping Forceps

BF



BF112R

BF113R

FOERSTER-BALLEGER

BF112R-BF113R

180 mm, 7"



BF116R

BF118R

180 mm

250 mm

7"

10"

RAMPLEY

BF116R-BF118R



BF120R

glattes Maul  
smooth jaws

BF121R

glattes Maul  
smooth jaws



BF122R

BF123R

FOERSTER-BALLEGER

BF120R-BF123R

245 mm, 9 3/4"



DE BAKEY Zahnung

Toothing DE BAKEY

# Korn- und Tupferzangen – Sponge- and Dressing Forceps

## ARAUMATA®

Organ- und Gewebefasszangen  
Organ- and Tissue Grasping Forceps

BF

2:3 Zahnreihen

2:3 Teeth rows

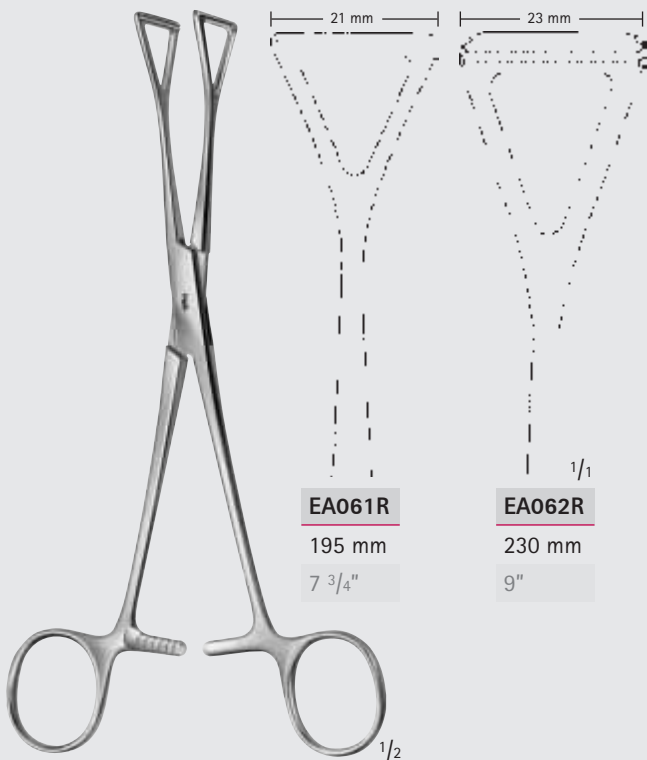

**EA061R**

195 mm  
7 3/4"

**EA062R**

230 mm  
9"

COLLIN

**EA061R-EA062R**

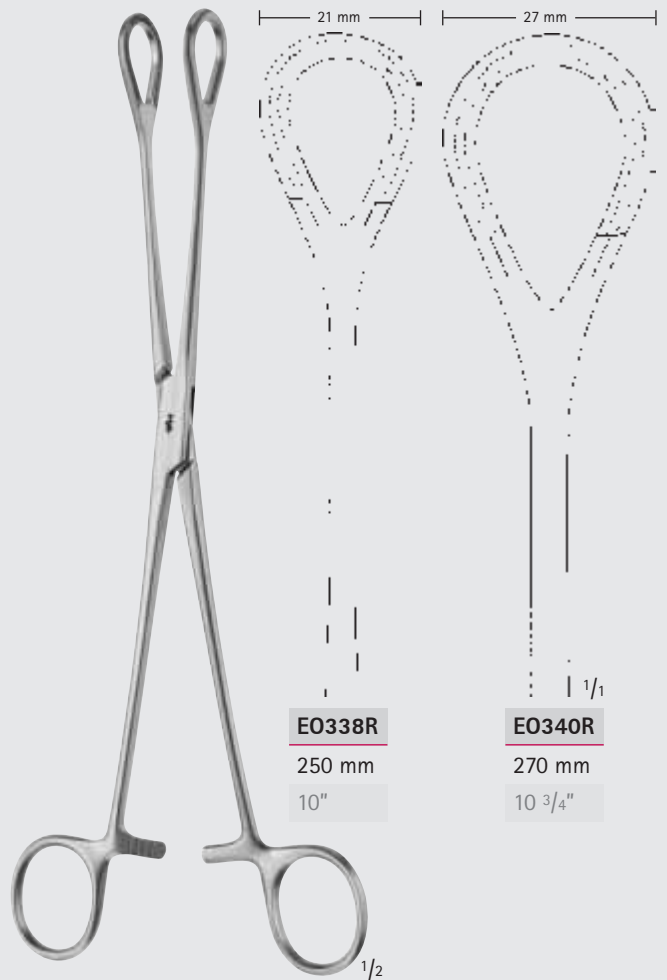

**EO338R**

250 mm  
10"

**EO340R**

270 mm  
10 3/4"

**EO338R-EO340R**



MILLIMETERS

## Korn- und Tupferzangen – Sponge- and Dressing Forceps

Tupfer-, Schwamm-, Organ- und Gewebefasszangen

Dressing-, Sponge Holding-, Organ- and Tissue Grasping Forceps

BF



**BH906R**

160 mm

6 1/4"



**BH908R**

160 mm

6 1/4"



**AN709R**

170 mm

6 3/4"

COLLIN

**AN709R-BH908R**



**AN710R**

HEYWOOD-SMITH

**AN710R**

200 mm, 8"



**AN711R**

HEYWOOD-SMITH MODIF.

**AN711R**

215 mm, 8 1/2"





## Korn- und Tupferzangen – Sponge- and Dressing Forceps

Tupfer-, Schwamm-, Organ- und Gewebefasszangen  
Dressing-, Sponge Holding-, Organ- and Tissue Grasping Forceps



**EO310R**

HEYWOOD-SMITH

**EO310R**

250 mm, 10"



**EO315R**

NOTO

**EO315R**

280 mm, 11"

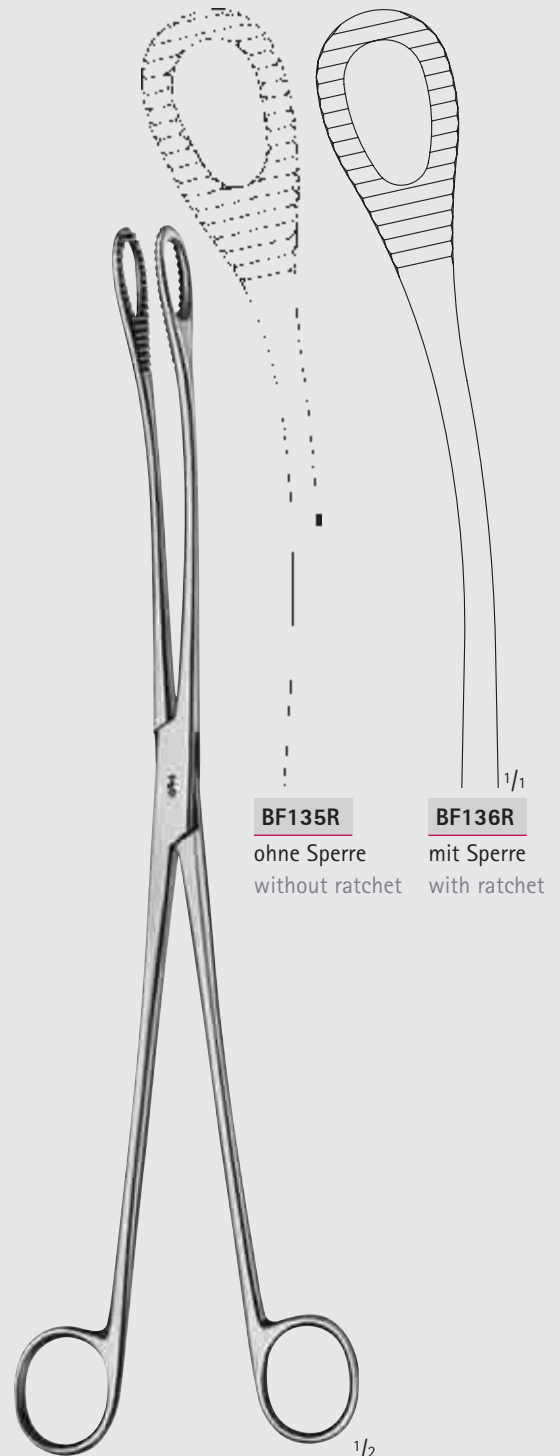

**BF135R**  
ohne Sperre  
without ratchet

**BF136R**  
mit Sperre  
with ratchet

KELLY

**BF135R-BF136R**

320 mm, 12 3/4"

**BF**

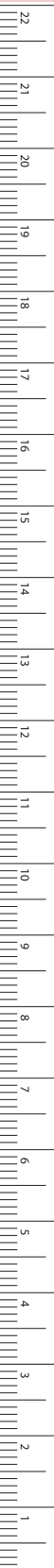

MILLIMETERS

## Korn- und Tupferzangen – Sponge- and Dressing Forceps

Sehnenfazzangen

Tendon Seizing Forceps

BF



HERZ

**BF303R**

Sehnenfazzange

Tendon seizing forceps

155 mm, 6"



JACKSON

**BF306R**

Sehnenfazzange

4 x 5 Zähne

Tendon seizing forceps

4 x 5 teeth

150 mm, 6"



**FO950R**

Sehneneinflechtkelemme

Tendon interlacing forceps

150 mm, 6"



**FO951R**

Sehneneinflechtkelemme

Tendon interlacing forceps

150 mm, 6"

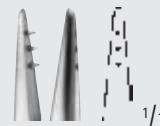
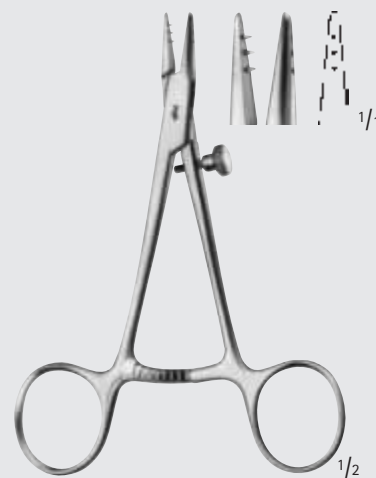

**BF307R**

Sehnenfazzange

Tendon seizing forceps

120 mm, 4 3/4"



## Korn- und Tupferzangen – Sponge- and Dressing Forceps

### Sehnenfasszangen

### Tendon Seizing Forceps

**BF**

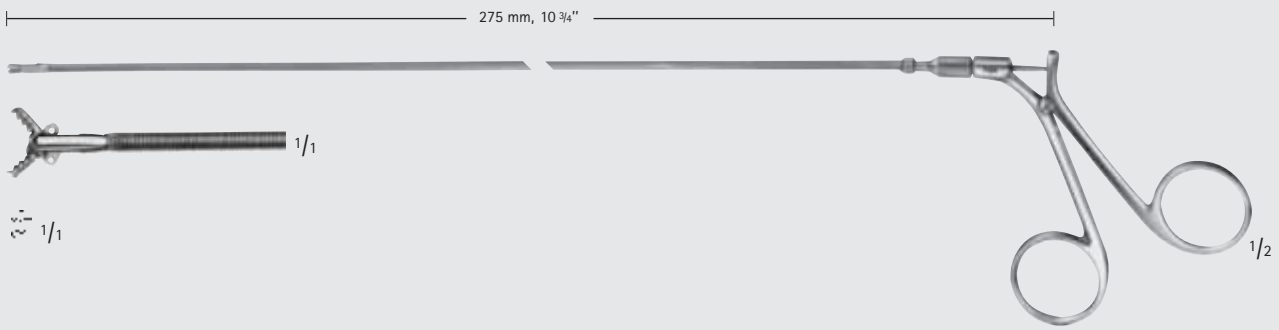

**JÄGER**

**BF325R**

Sehnen- und Kreuzband-  
Durchziehzange  
flexibler Schaft

Tendon- and cross ligament  
passing forceps  
flexible shaft



BF315R	BF316R	BF324R	BF326R
gebogen curved	gebogen curved	gerade straight	gerade straight
150 mm	185 mm	150 mm	185 mm
6"	7 1/4"	6"	7 1/4"

**BRAND**

**BF315R-BF326R**

Sehnenführungszangen  
Tendon holding forceps



**KLEINERT-KUTZ**

**BF320R**

Sehnedurchziehzange  
Tendon passing forceps  
205 mm, 8"



MILLIMETERS

## Korn- und Tupferzangen – Sponge- and Dressing Forceps

Arterien- und Gewebefassungen

Artery Traction- and Tissue Grasping Forceps

weitere Gewebefassungen siehe Rubrik EA  
further Tissue grasping forceps see section EA

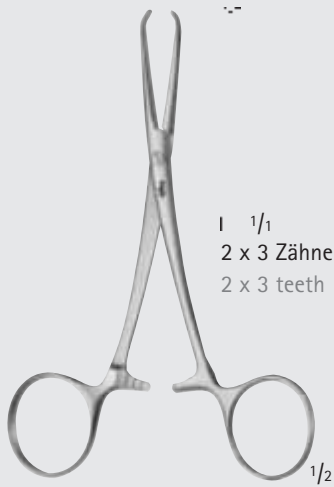

POIRIER

**BF299R**

125 mm, 5"

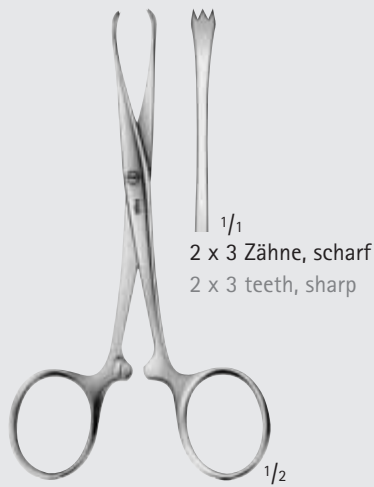

CHAPUT

**BF300R**

125 mm, 5"



TUFFIER

**BF301R**

125 mm, 5"

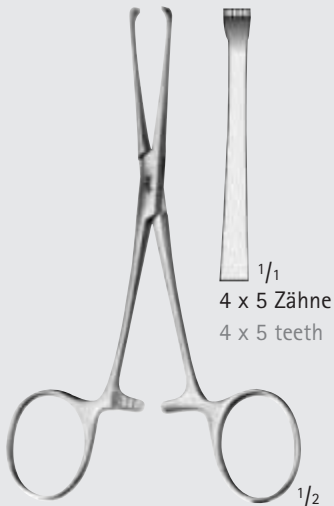

BABY-ALLIS

**EA012R**

130 mm, 5 1/8"

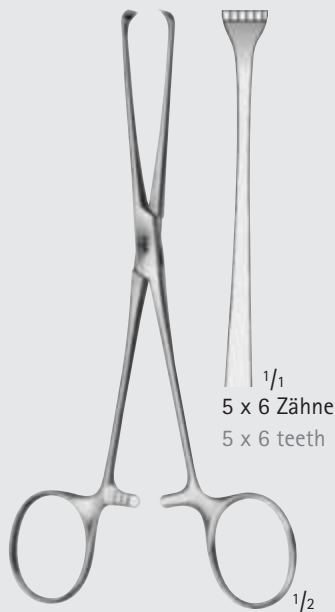

BOYS-ALLIS

**EA010R**

155 mm, 6"

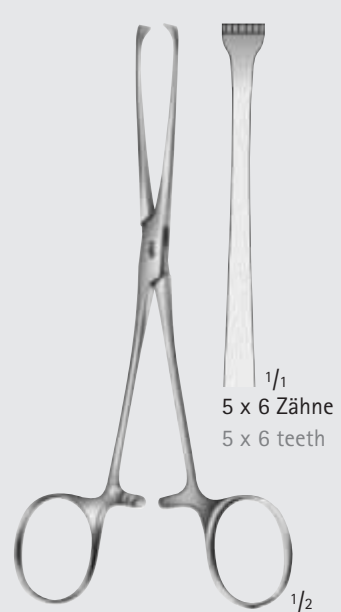

ALLIS

**EA016R**

155 mm, 6"

BF







## Korn- und Tupferzangen – Sponge- and Dressing Forceps Organ- und Gewebefasszangen Organ- and Tissue Grasping Forceps

**BF**

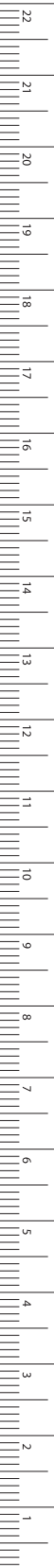

MILLIMETERS

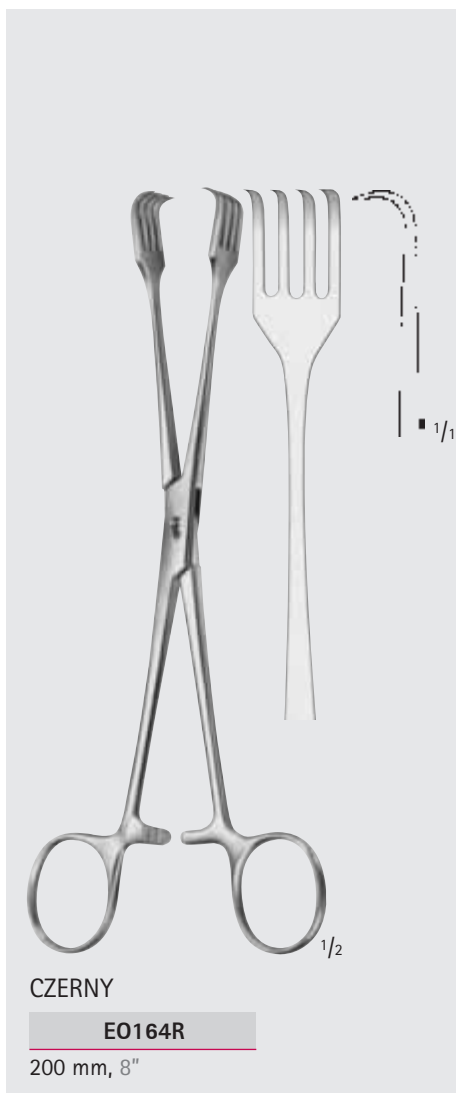
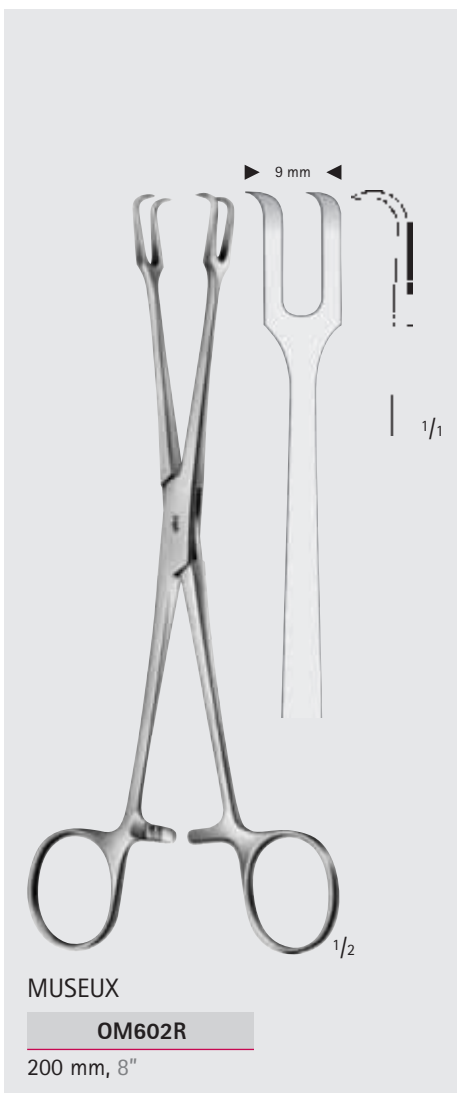

## Korn- und Tupferzangen – Sponge- and Dressing Forceps

Organ- und Gewebefasszangen

Organ- and Tissue Grasping Forceps

BF

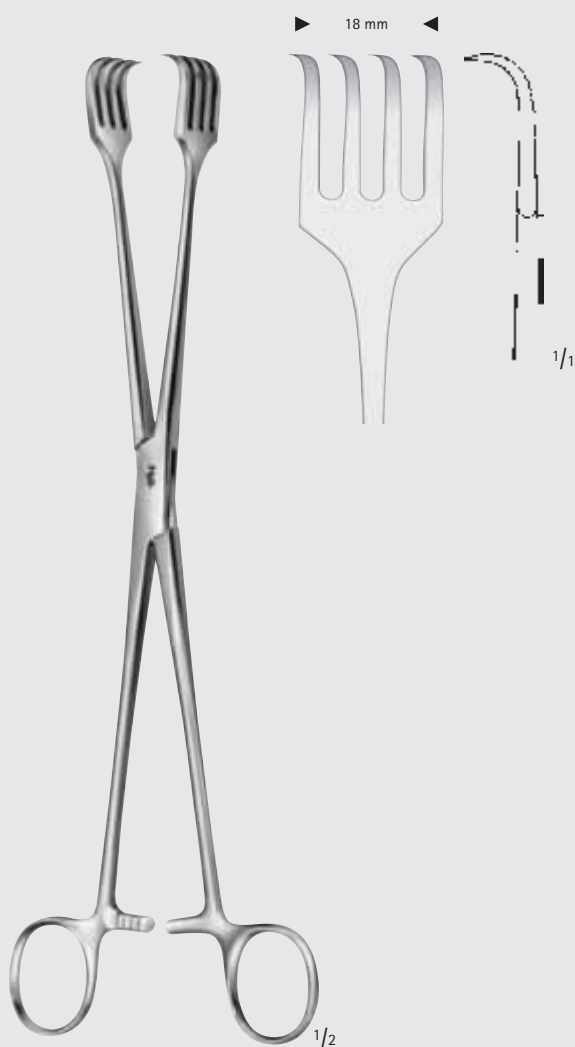

AESCULAP-PRATT

EO165R

260 mm, 10 1/4"



PRATT

EO166R

270 mm, 10 3/4"



## Korn- und Tupferzangen – Sponge- and Dressing Forceps Organ- und Gewebefasszangen Organ- and Tissue Grasping Forceps

BF



SCHRÖDER

EO110R

250 mm, 10"



WILSON

EO112R

240 mm, 9 1/2"

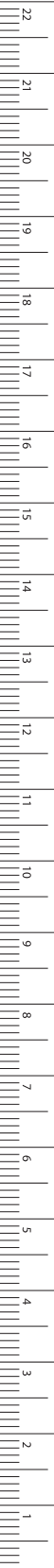

# Korn- und Tupferzangen – Sponge- and Dressing Forceps

Fremdkörperzangen

Foreign Body Forceps

BF



1/1

PITHA

EF921R

220 mm, 8 3/4"

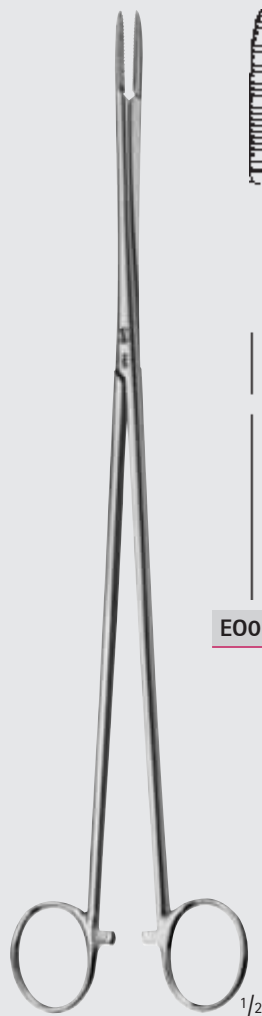

EO060R

EO061R

PELKMANN

EO060R-EO061R

260 mm, 10 1/4"



# Korn- und Tupferzangen – Sponge- and Dressing Forceps

Tuchklemmen  
Towel Clamps

**BF**

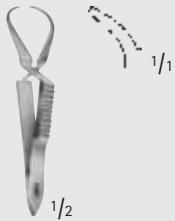

**BF401R**

55 mm, 2 1/8"

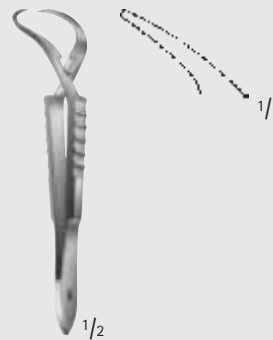

JONES

**BF407R**

85 mm, 3 3/8"



ENGL.MOD.

**BF408R**

85 mm, 3 3/8"

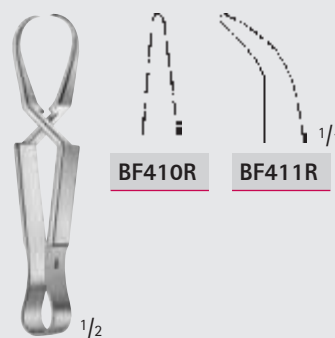

SCHAEDEL

**BF410R-BF411R**

85 mm, 3 3/8"



MILLIMETERS

# Korn- und Tupferzangen – Sponge- and Dressing Forceps

Tuchklemmen

Towel Clamps

BF

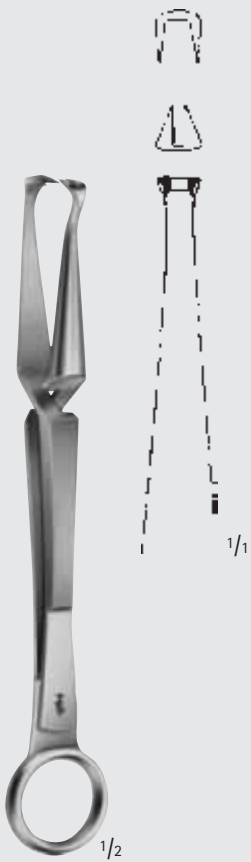

DOYEN

**BF417R**

180 mm, 7"

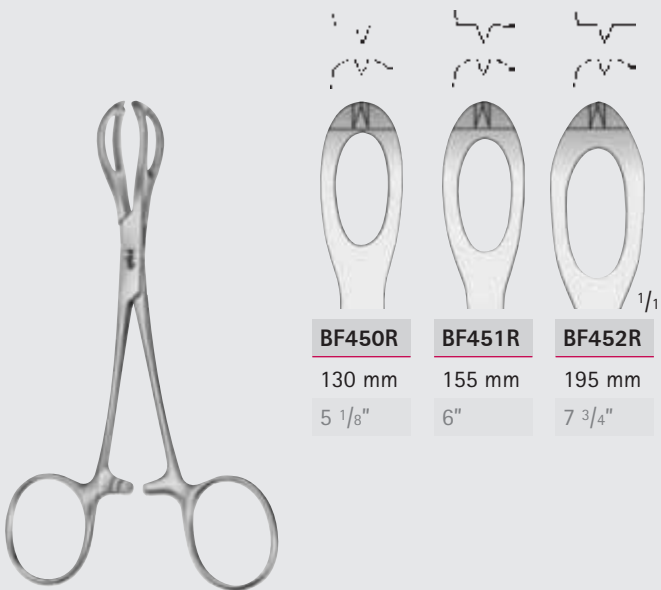

**BF450R**

130 mm

5 1/8"

**BF451R**

155 mm

6"

**BF452R**

195 mm

7 3/4"

LANE

**BF450R-BF452R**



# Korn- und Tupferzangen – Sponge- and Dressing Forceps

Tuchklemmen  
Towel Clamps

**BF**

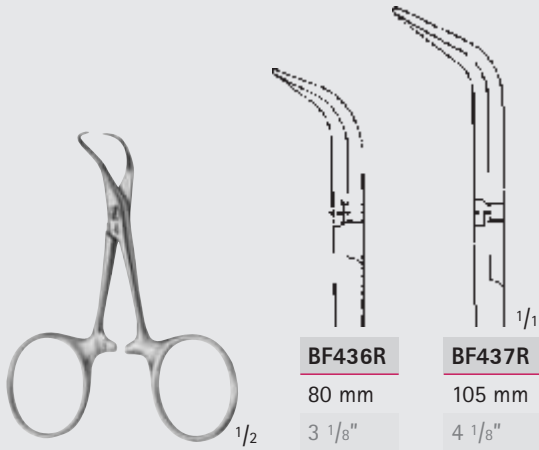

**BF436R**

80 mm

3 1/8"

**BF437R**

105 mm

4 1/8"

BACKHAUS

**BF436R-BF437R**

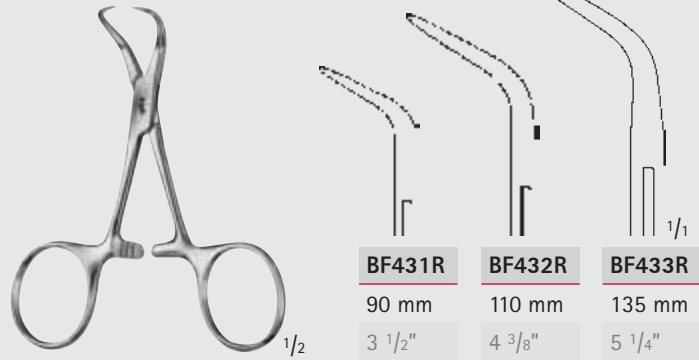

**BF431R**

90 mm

3 1/2"

**BF432R**

110 mm

4 3/8"

**BF433R**

135 mm

5 1/4"

BACKHAUS

**BF431R-BF433R**

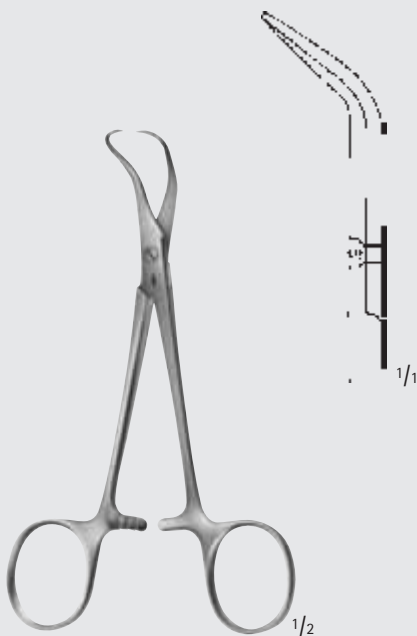

BACKHAUS-KOCHER

**BF444R**

135 mm, 5 1/4"

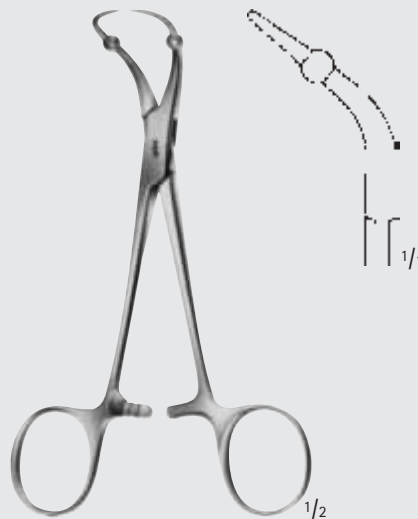

ROEDER

**BF448R**

135 mm, 5 1/4"

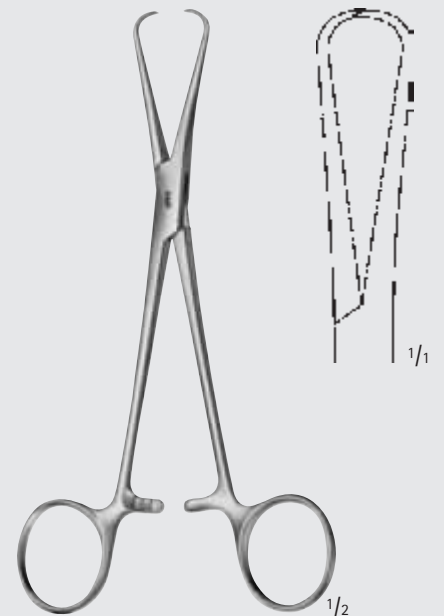

BERNHARD

**BF426R**

160 mm, 6 1/4"



MILLIMETERS

## Korn- und Tupferzangen – Sponge- and Dressing Forceps

Tuchklemmen

Towel Clamps

BF



ROBIN

**BF439R**

mit Kabelhalterung bis 5 mm  
Kabelstärke  
with holders for cable up to 5 mm  
135 mm, 5 1/4"

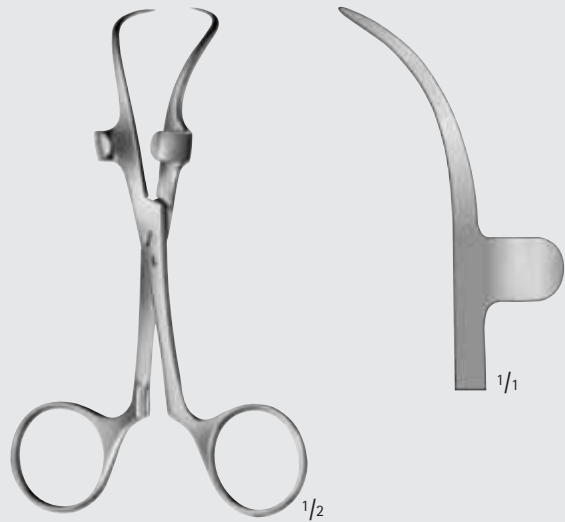

ROBIN

**BF440R**

mit Schlauchhalterung bis 13 mm  
Schlauchstärke  
with holders for tubing up to 13 mm  
135 mm, 5 1/4"

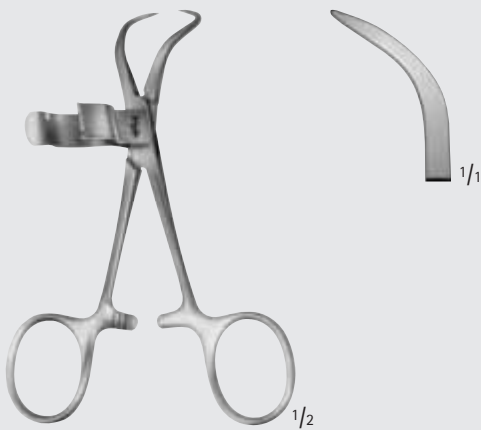

**BF442R**

mit Schlauchhalterung bis  
15 mm Schlauchstärke  
with holders for tubing up to 15 mm  
110 mm, 4 3/8"

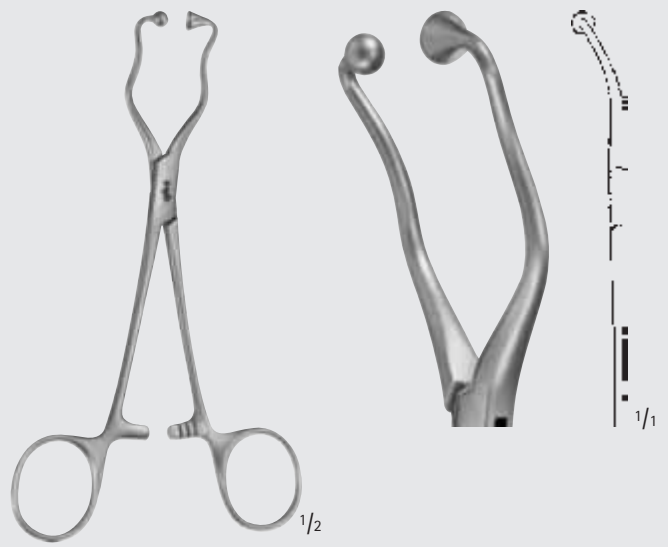

**BF443R**

Doppelschlauch-Fixierklemme  
atraumatische Fassfläche  
Tube fixation forceps with  
atraumatic jaw parts  
140 mm, 5 1/2"

Besonders geeignet für HLM-  
Schläuche in der Herzchirurgie  
Especially suitable for HLM  
tubes for cardiovascular surgery





## Korn- und Tupferzangen – Sponge- and Dressing Forceps

Tuchklemmen  
Towel Clamps

**BF**

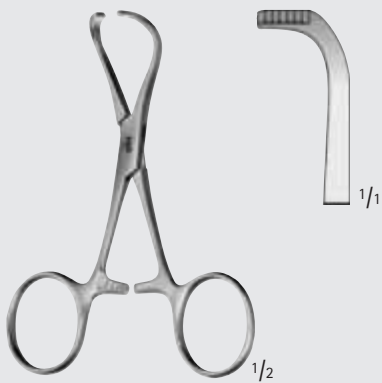

LORNA

**BF461R**

nicht perforierend  
non-perforating  
95 mm, 3 3/4"



LORNA

**BF463R**

nicht perforierend  
non-perforating  
130 mm, 5 1/8"

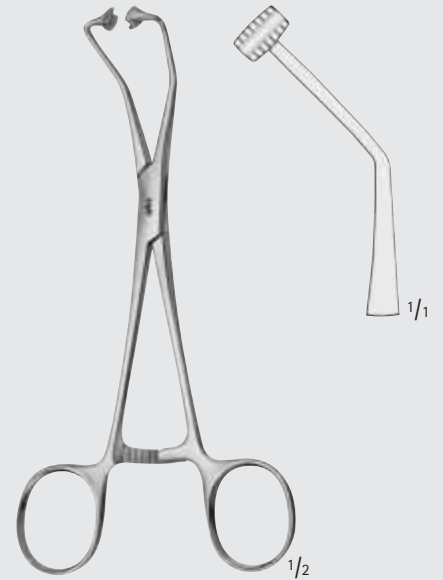

**BF460R**

für Papiertücher  
for paper cloths  
150 mm, 6"

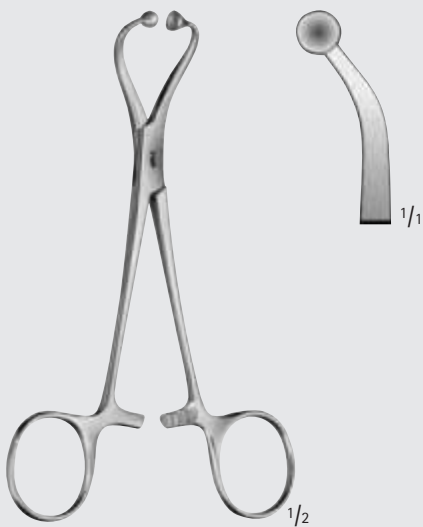

**BF464R**

für Papiertücher  
for paper cloths  
140 mm, 5 1/2"

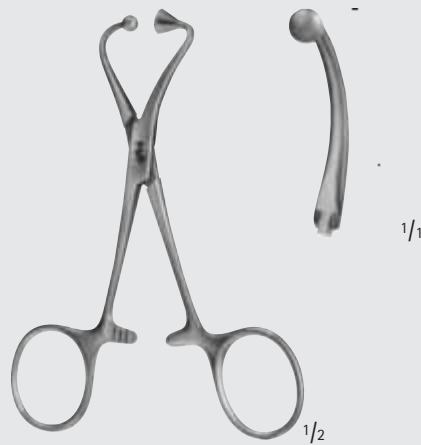

**BF465R**

für Papiertücher  
for paper cloths  
115 mm, 4 1/2"

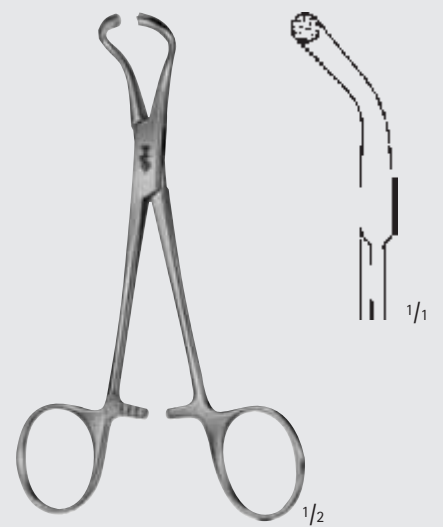

**BF466R**

für Papiertücher  
for towel cloths  
135 mm, 5 1/4"

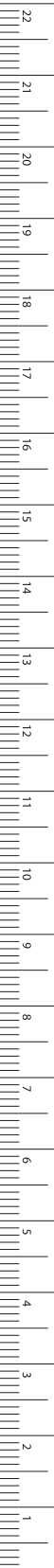

MILLIMETERS

## Korn- und Tupferzangen – Sponge- and Dressing Forceps

Tuchklemmen

Towel Clamps

BF

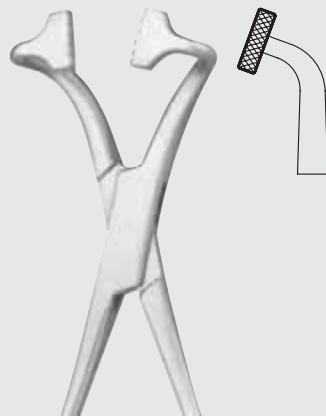

**BF458R**

100 mm

4"

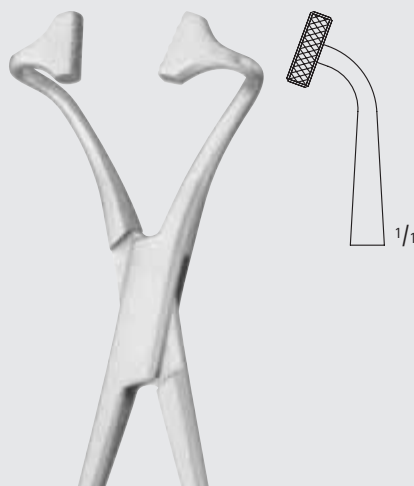

**BF459R**

135 mm

5 1/4"

**BF458R-BF459R**

nicht perforierend  
non-perforating



## Korn- und Tupferzangen – Sponge- and Dressing Forceps Sterilisierklammern für Ringgriff-Instrumente Safety Pins for Holding Ring Handle Instruments

BF



BUNT

**BF491R**

105 mm, 4 1/8"



MAYO

**BF493R**

140 mm, 5 1/2"

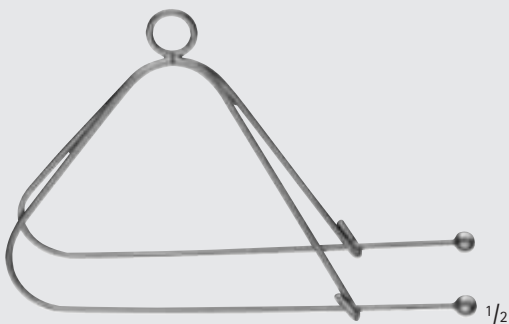

MAYO

**BF494R**

doppelt

double

125 mm, 5"

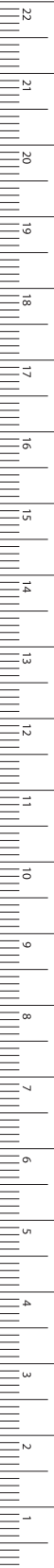

MILLIMETERS

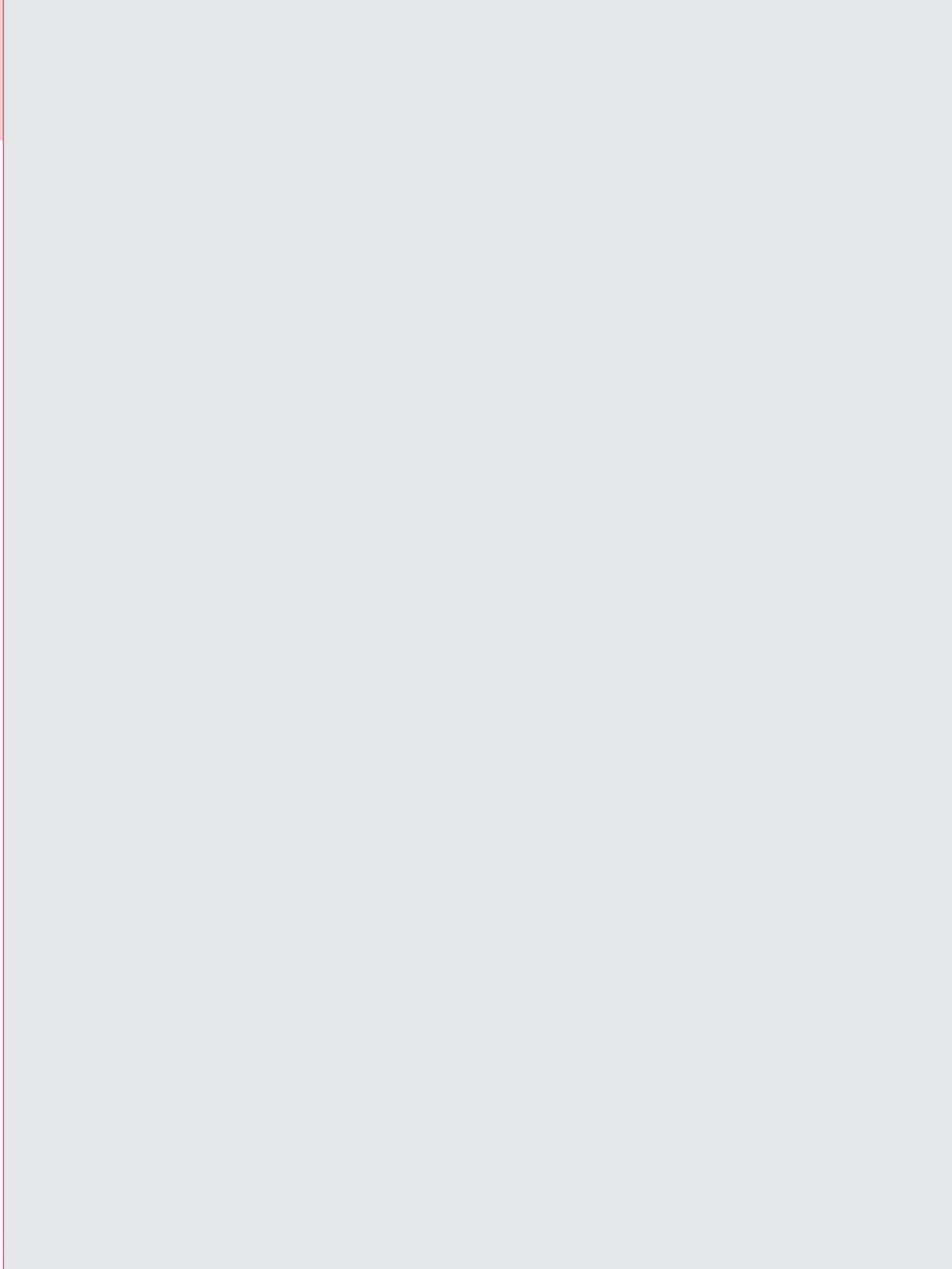

BH



Arterienklemmen, Bulldogklemmen,  
Gefäßclipe, Approximatoren  
Haemostatic Forceps, Bulldog Clamps,  
Vessel Clips, Approximators

## Arterienklemmen – Hemostatic Forceps

Gefäßclips nach BIEMER, Gefäßclips nach MEHDORN, Minigröße  
BIEMER Vessel Clips, MEHDORN Vessel Clips, Mini Size

### für temporären Gebrauch

- Maulinnenflächen schräg gerieft, für schonendes, sicheres Festhalten der Gefäße.
- Der fest eingestellte Schließdruck gewährt risikofreie Anwendung.
- Schließkraft-Ermittlung: bei  $\frac{1}{3}$  der Gesamtauflänge von vorn und einer Maulöffnung von 1 mm (siehe Zeichnung)

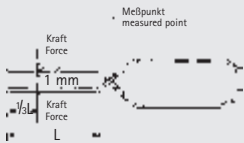

### for temporary occlusion

- Blade gripping surface with oblique serrations for safe but careful gripping of vessels.
- No risk due to rigidly fixed pressure measure guarantees application without any risk.
- Closing force is measured at  $\frac{1}{3}$  of the blades at 1 mm opening (see illustration).

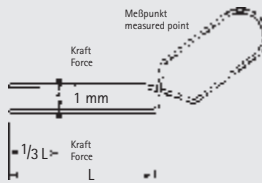

### BIEMER

	Maul- öffnung Jaw opening	Maul- länge Jaw length	Schließkraft Closing force	Anlege- pinzette Applying forceps
<b>FD560R</b>	4 mm	6 mm	30 - 40 g (0,29 - 0,39 N)	<b>FD568R</b> oder / or <b>FD569R</b>
<b>FD561R</b>	5 mm	9 mm	30 - 40 g (0,29 - 0,39 N)	
<b>FD562R</b>	5 mm	9 mm	20 - 25 g (0,20 - 0,25 N)	

(gekennzeichnet durch gelb gefärbte Federenden)  
für Gefäße mit  $\varnothing$  0,5 - 2,0 mm.

(identified by yellow colored spring ends)  
for vessels diam. 0.5 - 2.0 mm.

### MEHDORN

	Maul- öffnung Jaw opening	Maul- länge Jaw length	Schließkraft Closing force	Anlege- pinzette Applying forceps
<b>FD552R</b>	4 mm	1,0 mm	10 - 15 g (0,10 - 0,15 N)	<b>FD578R</b>
<b>FD554R</b>	4 mm	1,4 mm	15 - 20 g (0,15 - 0,20 N)	
<b>FD556R</b>	6 mm	1,0 mm	10 - 15 g (0,10 - 0,15 N)	
<b>FD558R</b>	6 mm	1,4 mm	15 - 20 g (0,15 - 0,20 N)	

(gekennzeichnet durch gelb eingefärbte Federenden)  
für Gefäße mit  $\varnothing$  0,5 - 1,5 mm (extra-intracraniale Anastomosen).

(identified by yellow colored spring ends)  
for vessels diam. 0.5 - 1.5 mm (extra-intercranial anastomosis).

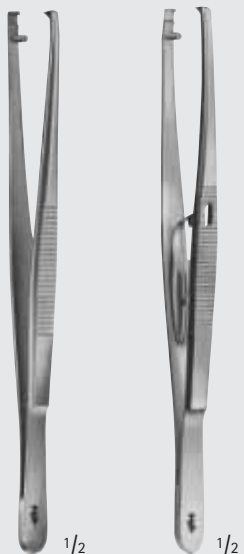

**FD568R**

ohne Schloss  
without lock

**FD569R**

mit Schloss  
with lock

### BIEMER

#### **FD568R-FD569R**

Anlegepinzetten für Gefäßclips  
nach BIEMER und Approximatoren  
nach BIEMER-MÜLLER und MÜLLER

Applying forceps for BIEMER vessel  
clips and BIEMER-MÜLLER and  
MÜLLER approximators

140 mm, 5 1/2"

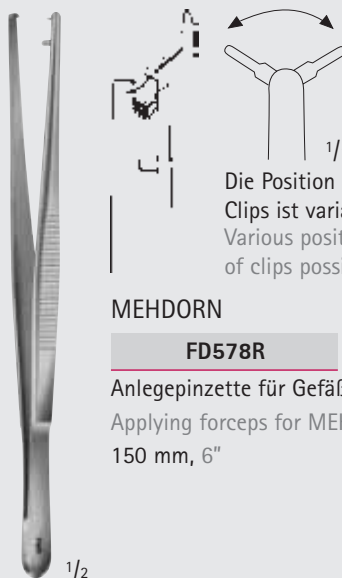

### MEHDORN

#### **FD578R**

Anlegepinzette für Gefäßclips nach MEHDORN

Applying forceps for MEHDORN vessel clips  
150 mm, 6"

Die Position des  
Clips ist variabel  
Various positions  
of clips possible



## Arterienklemmen – Hemostatic Forceps

### Approximatoren, nach BIEMER-MÜLLER, BIEMER

#### BIEMER-MÜLLER, BIEMER Approximators





#### für Mikro-Gefäßanastomosen im oberflächlichen Bereich

- Maulinnenflächen schräg gerieft, für schonendes, sicheres Festhalten der Gefäßenden.
- Der fest eingestellte Schließdruck garantiert risikofreie Anwendung.
- Der Abstand zwischen den Clips ist durch einfaches Verschieben variabel und wird durch Verkantung selbsttätig fixiert.
- Die leichte Konstruktion (geringes Gewicht, kleine Dimension) ermöglicht im angelegten Zustand einfaches, verzerrungsfreies Umdrehen, um auf der unteren Gefäßseite weiterzunähen.

#### for micro vessel anastomosis in the superficial range

- Blade gripping surface with oblique serrations for careful but safe holding of the vessel ends.
- No risk due to rigidly fixed pressure measure.
- Adjustable distance between the clips and automatic fixation by tilting.
- Even when applied, the lightweight construction allows easy, distortionless turning and makes suturing possible on the other side of the vessel.

#### BIEMER-MÜLLER

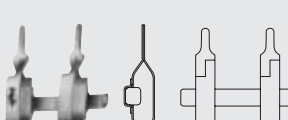
Mikro-Approximatoren Micro approximators	Maul- öffnung Jaw opening	Maul- länge Jaw length	Schließkraft Closing force	Anlege- pinzette Applying forceps
<b>FD611R</b> 	5 mm	9 mm	25 - 30 g (0,25 - 0,29 N)	<b>FD568R</b> oder / or <b>FD569R</b>
<b>FD612R</b> 	5 mm	9 mm	25 - 30 g (0,25 - 0,29 N)	
<b>FD613R</b> 	5 mm	9 mm	25 - 30 g (0,25 - 0,29 N)	
<b>FD614R</b> 	5 mm	9 mm	25 - 30 g (0,25 - 0,29 N)	
<b>FD615R</b> 	3 mm	4,5 mm	25 - 30 g (0,25 - 0,29 N)	

#### BIEMER

<b>FD571R</b> 	4 mm	6 mm	30 - 40 g (0,29 - 0,39 N)	<b>FD572R</b>
---	------	------	------------------------------	---------------

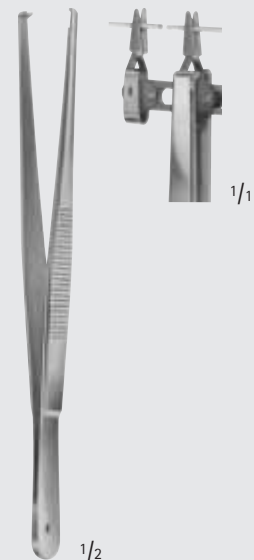

#### BIEMER

#### **FD572R**

Anlegepinzette für Gefäß-  
Approximator nach BIEMER  
Applying forceps for BIEMER  
vessel approximator  
145 mm, 5 3/4"

## Arterienklemmen – Hemostatic Forceps

Approximator, Nerv-Approximator nach BIEMER

Approximator, BIEMER Approximator for Nerves

für Mikro-Gefäßanastomosen im tieferen Bereich,  
außerdem für experimentelle Chirurgie

- Maulinnenflächen schräg gerieft, für schonendes, sicheres Festhalten der Gefäßenden.
- Der Schließdruck wird mit dem Schlüssel FD576R eingestellt.
- Der Abstand zwischen den Clips ist variabel und wird mit dem Schlüssel FD576R fixiert.

for micro vessel anastomosis in the deeper range,  
also for experimental surgery

- Blade gripping surface with oblique serrations for careful but safe holding of the vessel ends.
- The pressure measure is adjusted with key FD576R.
- The distance between the clips is variable and fixed with key FD576R.

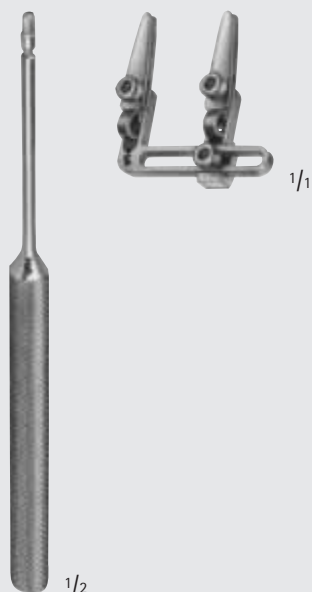

### FD575R

Approximator komplett, mit  
Schlüssel FD576R  
Approximator complete,  
with key FD576R

zur sicheren Adaption bei Nervanastomosen

- Das Durchstrecken des Nervenzentrum mit feinen Nadeln verhindert stärkere pathologische Veränderungen.
- Nadeln mit Schlüssel FD576R austauschbar.
- Abstand zwischen den Nadeln variabel und mit Schlüssel FD576R fixierbar.

for safe adaption of nerve anastomoses

- Piercing the nerve centre with fine needles prevents strong pathological changes.
- Needles can be exchanged with key FD576R.
- Distance between the needles is variable and can be fixed with key FD576R.



BIEMER

### FD635R

Nerv-Approximator kom-  
plett, mit Schlüssel FD576R

Approximator for nerves  
complete, with key FD576R

### FD636R

1 Paar Ersatznadeln  
1 pair of spare needles





## Arterienklemmen – Hemostatic Forceps

Gefäßclips  
Vessel Clips

BH

Schließdruck Closing force					
50 g	<b>FE010K</b>	<b>FE011K</b>	<b>FE012K</b>	<b>FE013K</b>	<b>FE014K</b>
80 g	<b>FE020K</b>	<b>FE021K</b>	<b>FE022K</b>	<b>FE023K</b>	<b>FE024K</b>
	gerade straight	gebogen curved	Spitze gebogen curved tips	zur Seite abgewinkelt angled to side	kniegebogen knee-bent

### MÜLLER

#### **FE010K-FE024K**

Temporäre Gefäßclips mit atraumatischem Maulprofil  
Non-traumatic vessel clips, temporary



Maulprofil fein kariert  
jaw profiles, finely  
cross-serrated

### MÜLLER

#### **FE005K**

Fadenklemme  
Ligature Forceps



MILLIMETERS

## Arterienklemmen – Hemostatic Forceps

Gefäßclips

Vascular Clips

DE BAKEY Zahnung

Toothing DE BAKEY

Gefäßclips nach MÜLLER

### Merkmale:

- Atraumatisches Maulprofil
- Beidseitig angebrachte Griffplateaus zum sicheren Anlegen und Abnehmen des Clips.
- Exakt definierter Schließdruck für arterielle und venöse Gefäße.
- Gefäßclips eindeutig mit Schließdruck gekennzeichnet.
- Geschlossener Maulkasten zur sicheren Maulführung. Kein ungewolltes Verfangen des Fadens möglich.

MÜLLER Vascular Clips

### Features:

- Atraumatic mouth profile
- Handle plateau mounted on both sides for secure application and removal of the clip.
- Exactly defined closing pressure for arterial and venous vessels.
- Vascular clips are clearly marked with closing pressure.
- Closed mouth box guarantees precise guidance of the working tips. No risk of threads getting tangled up in clip.

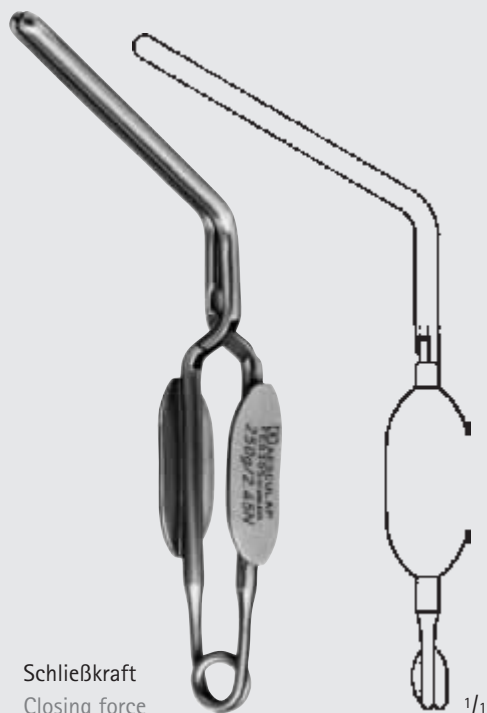

Schließkraft  
Closing force

MÜLLER

250 g **FE030S**

350 g **FE040S**

gerade  
straight

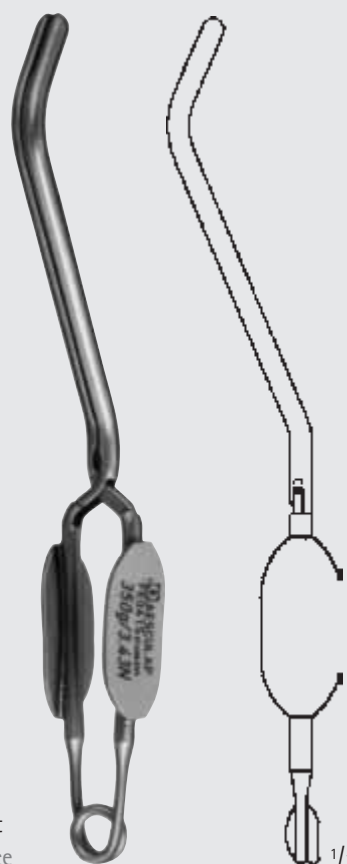

Schließkraft  
Closing force

MÜLLER

250 g **FE031S**

350 g **FE041S**

gebogen  
curved



DE BAKEY Zahnung

Toothing DE BAKEY

## Arterienklemmen – Hemostatic Forceps

Gefäßclips

Vascular Clips

BH

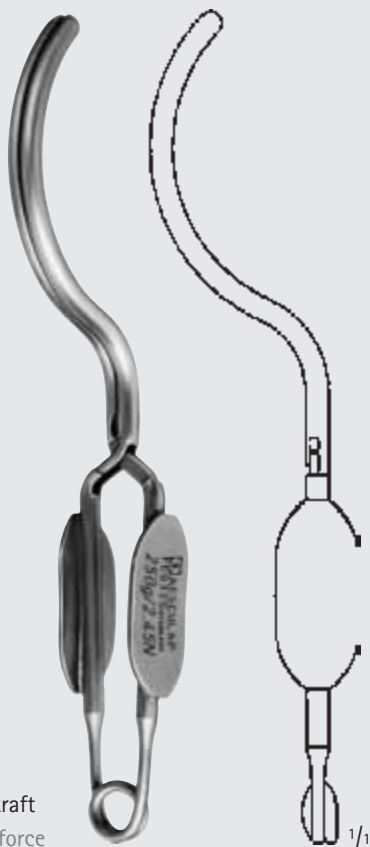

Schließkraft  
Closing force

MÜLLER

250 g **FE032S**

350 g **FE042S**

Spitze gebogen  
curved tips

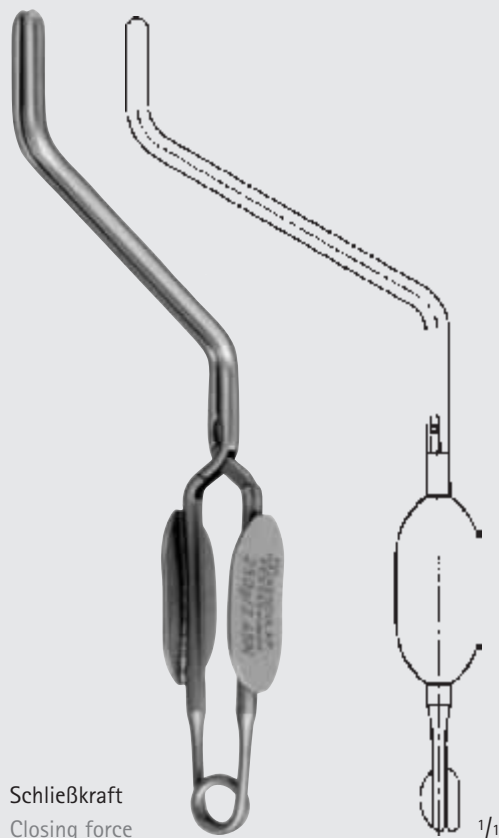

Schließkraft  
Closing force

MÜLLER

250 g **FE034S**

350 g **FE044S**

kniegebogen  
knee-bent

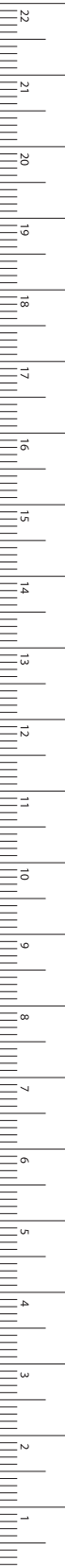

## Arterienklemmen – Hemostatic Forceps

Bulldogklemmen

Bulldog Clamps

BH



JOHNS-HOPKINS

**BH018R**

Zange zum Anlegen und Abnehmen der Bulldogklemmen BH011R - BH031R und FB420R - FB427R

Forceps for applying and removing bulldog clamps BH011R - BH031R and FB420R - FB427R

240 mm, 9 3/4"

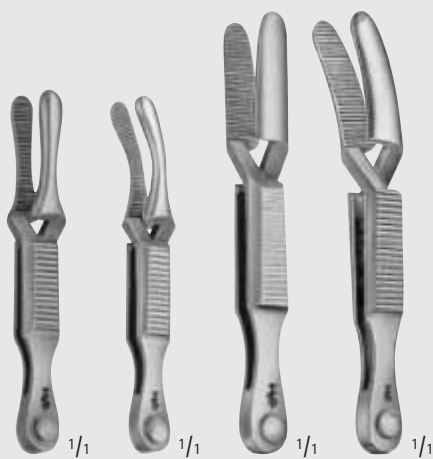

**BH020R** **BH021R** **BH026R** **BH027R**  
**BH022R** **BH023R**

DIEFFENBACH

Gesamtlänge: Maullänge:  
 Total length: Jaw length:

<b>BH020R</b>	38 mm, 1 1/2"	12 mm, 1/2"
<b>BH022R</b>	48 mm, 2"	16 mm, 5/8"
<b>BH021R</b>	38 mm, 1 1/2"	12 mm, 1/2"
<b>BH023R</b>	48 mm, 2"	16 mm, 5/8"
<b>BH026R</b>	58 mm, 2 1/8"	16 mm, 5/8"
<b>BH027R</b>	58 mm, 2 1/8"	16 mm, 5/8"



**BH011R-BH017R**

JOHNS-HOPKINS

Gesamtlänge: Maullänge:  
 Total length: Jaw length:

<b>BH011R</b>	38 mm, 1 1/2"	12 mm, 1/2"
<b>BH012R</b>	48 mm, 2"	17 mm, 5/8"
<b>BH013R</b>	56 mm, 2 1/8"	25 mm, 1"
<b>BH014R</b>	63 mm, 2 1/2"	30 mm, 1 3/16"
<b>BH015R</b>	70 mm, 2 3/4"	33 mm, 1 1/4"
<b>BH016R</b>	80 mm, 3 1/8"	42 mm, 1 3/4"
<b>BH017R</b>	91 mm, 3 1/2"	52 mm, 2"



## Arterienklemmen – Hemostatic Forceps

Bulldogklemmen

Bulldog Clamps

BH



1/1

DE BAKEY-HESS

**BH030R**

Gesamtlänge: 34 mm  
 Total length: 1 3/8"  
 Maullänge: 20 mm  
 Jaw length: 3/4"



**FB328R**

Gesamtlänge: 35 mm  
 Total length: 1 3/8"  
 Maullänge: 14 mm  
 Jaw length: 1/2"



**FB329R**

Gesamtlänge: 35 mm  
 Total length: 1 3/8"  
 Maullänge: 14 mm  
 Jaw length: 1/2"



**FB330R**

Gesamtlänge: 45 mm  
 Total length: 1 3/4"  
 Maullänge: 19 mm  
 Jaw length: 3/4"



1/1

**FB331R**

Gesamtlänge: 45 mm  
 Total length: 1 3/4"  
 Maullänge: 19 mm  
 Jaw length: 3/4"



1/1

DE BAKEY-HESS

**BH031R**

Gesamtlänge: 43 mm  
 Total length: 1 7/10"  
 Maullänge: 30 mm  
 Jaw length: 1 3/16"



DIETHRICH

**MB285R**

Gesamtlänge: 55 mm  
 Total length: 2 1/8"  
 Maullänge: 13 mm  
 Jaw length: 1/2"



DIETHRICH

**BH032R**

Gesamtlänge: 48 mm  
 Total length: 1 7/8"  
 Maullänge: 10 mm  
 Jaw length: 3/8"



1/1

DIETHRICH

**BH034R**

Gesamtlänge: 48 mm  
 Total length: 1 7/8"  
 Maullänge: 13 mm  
 Jaw length: 1/2"



MILLIMETERS

# Arterienklemmen – Hemostatic Forceps

Bulldogklemmen  
Bulldog Clamps

DE BAKEY Zahnung

AIRAUMATA®

Toothing DE BAKEY

Mini-Bulldogklemmen  
Schließdruck 180 g  
Mini-bulldog clamps  
Closing force 180 g

gerade  
straight

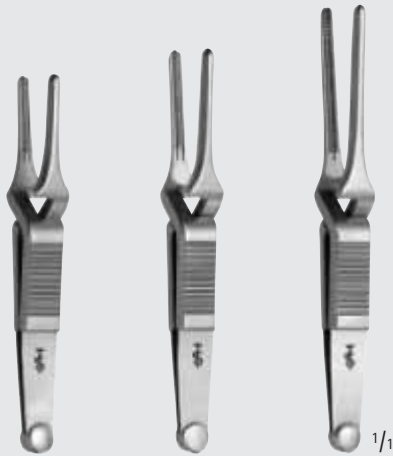

gewinkelt, 55°  
angled, 55°



curved  
gebogen

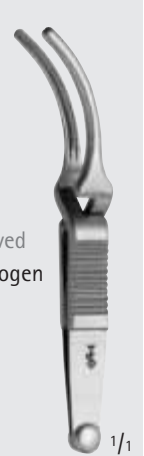

	<b>FB362R</b>	<b>FB364R</b>	<b>FB366R</b>	<b>FB363R</b>	<b>FB365R</b>	<b>FB367R</b>	<b>FB369R</b>
Gesamtlänge:	50 mm	55 mm	60 mm	50 mm	50 mm	55 mm	55 mm
Total length:	2"	2 1/8"	2 3/8"	2"	2"	2 1/8"	2 1/8"
Maullänge:	10 mm	14 mm	20 mm	10 mm	14 mm	20 mm	20 mm
Jaw length:	3/8"	1/2"	3/4"	3/8"	1/2"	3/4"	3/4"



DE BAKEY  
**FB352R**



DE BAKEY  
**FB353R**



GLOVER  
**FB431R**



DE BAKEY  
**FB357R**

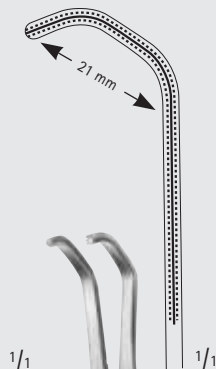

DE BAKEY  
**FB358R**



DE BAKEY  
**FB359R**



Gesamtlänge:	50 mm	48 mm	52 mm	73 mm	99 mm	95 mm
Total length:	2"	2"	2"	2 3/4"	4"	3 1/2"
Maullänge:	27 mm	27 mm	35 mm	38 mm	63 mm	54 mm
Jaw length:	1 1/8"	1 1/8"	1 1/3"	1 1/2"	2 1/2"	2 1/8"

BH



DE BAKEY Zahnung

## Arterienklemmen – Hemostatic Forceps

Bulldogklemmen

Bulldog Clamps

Toothing DE BAKEY

**AIRAUMATA**<sup>®</sup>

BH



DE BAKEY

**FB420R**

Gesamtlänge: 80 mm

Total length: 3 1/8"

Maullänge: 25 mm

Length of jaw: 1"

DE BAKEY

**FB422R**

90 mm

3 1/2"

35 mm

1 3/8"

DE BAKEY

**FB424R**

105 mm

4 1/8"

50 mm

2"

DE BAKEY

**FB426R**

124 mm

5"

68 mm

2 3/4"



DE BAKEY

**FB421R**

78 mm

3 1/8"

23 mm

1"

DE BAKEY

**FB423R**

86 mm

3 3/8"

31 mm

1 1/8"

DE BAKEY

**FB425R**

97 mm

3 3/4"

42 mm

1 3/4"

DE BAKEY

**FB427R**

114 mm

4 1/2"

58 mm

2 3/8"



GLOVER

**FB432R**

Gesamtlänge: 68 mm

Total length: 2 3/4"

Maullänge: 33 mm

Length of jaw: 1 3/8"

GLOVER

**FB434R**

96 mm

3 3/4"

50 mm

2"

GLOVER

**FB436R**

117 mm

4 3/4"

69 mm

2 3/4"



GLOVER

**FB433R**

65 mm

2 1/2"

33 mm

1 3/8"

GLOVER

**FB435R**

91 mm

3 1/2"

50 mm

2"

GLOVER

**FB437R**

110 mm

4 3/8"

69 mm

2 3/4"



MILLIMETERS

## Arterienklemmen – Hemostatic Forceps

Feine Arterieklemmen

Delicate Hemostatic Forceps

BH

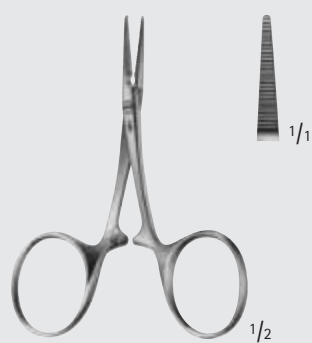
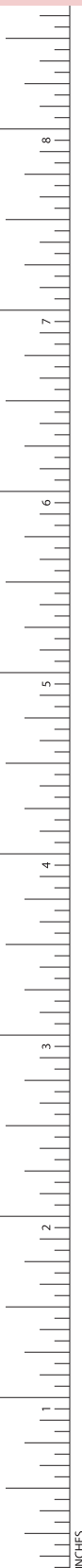

CARREL

**BH100R**

85 mm, 3 3/8"

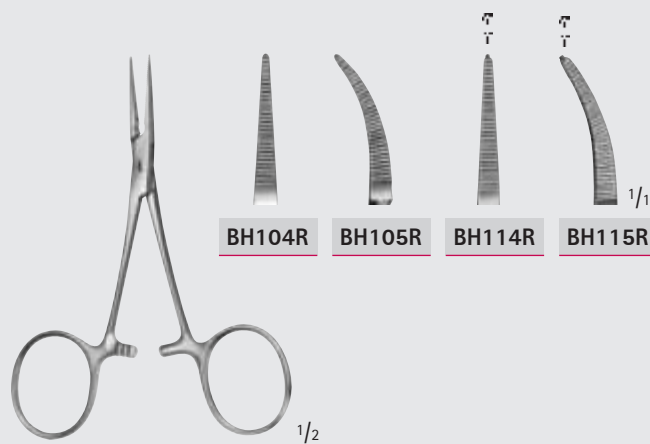

BABY-MOSQUITO  
(HARTMANN)

**BH104R-BH115R**

100 mm, 4"

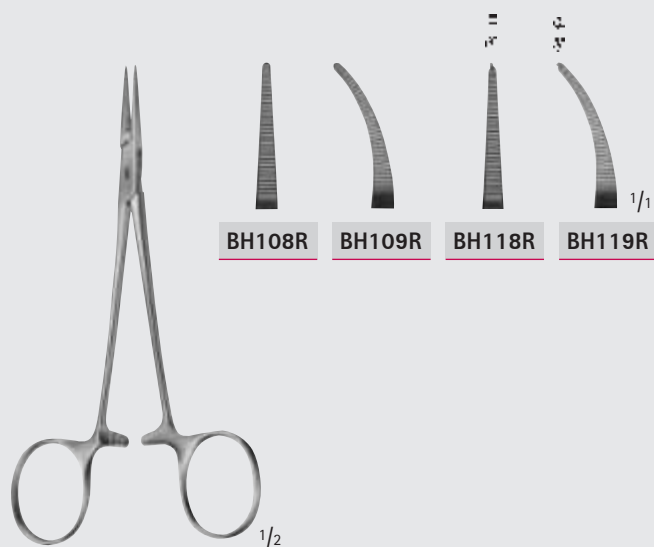

MICRO-HALSTED

**BH108R-BH119R**

125 mm, 5"

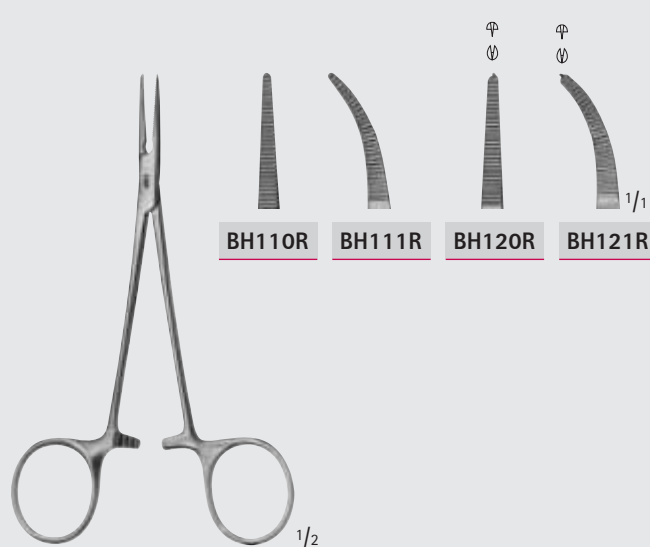

HALSTED-MOSQUITO

**BH110R-BH121R**

125 mm, 5"





## Arterienklemmen – Hemostatic Forceps

### Feine Arterienklemmen

### Delicate Hemostatic Forceps

**BH**

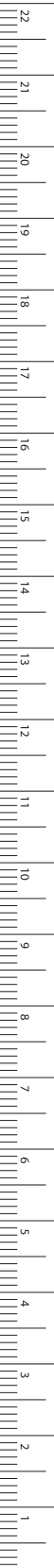

MILLIMETERS



**JACOBSON**  
**BH106R-MB229R**  
 125 mm, 5"



**PROVIDENCE-HOSPITAL**  
**BH130R-BH131R**  
 140 mm, 5 1/2"

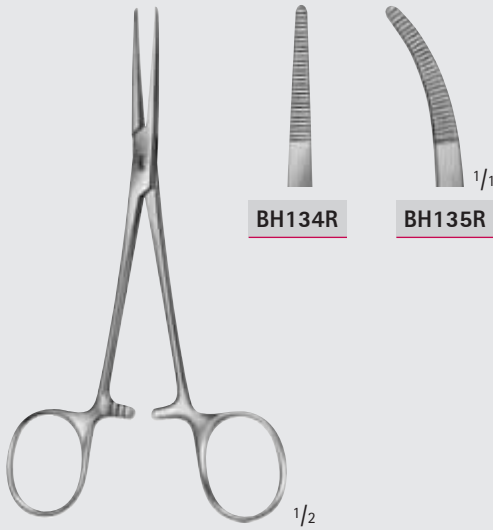

**KELLY**  
**BH134R-BH135R**  
 140 mm, 5 1/2"



**DANDY**  
**BH139R-BH143R**  
 seitwärts gebogen  
 curved to side  
 140 mm, 5 1/2"

## Arterienklemmen – Hemostatic Forceps

Feine Arterienklemmen

Delicate Hemostatic Forceps

BH

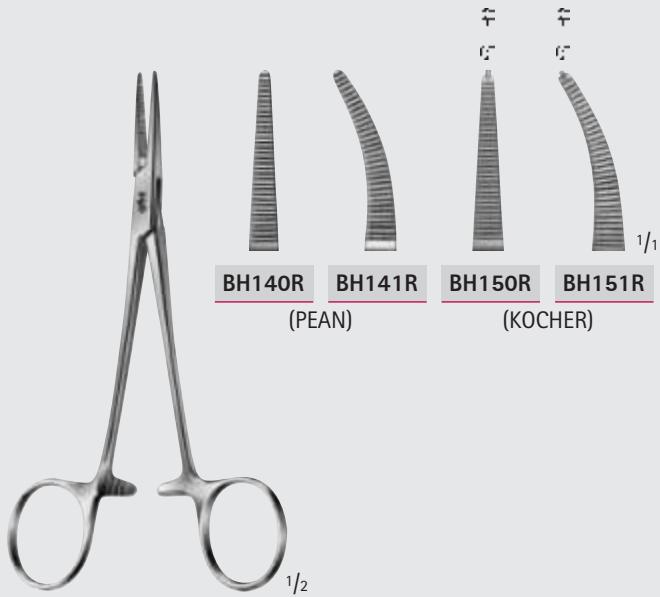

BABY-CRILE

**BH140R-BH151R**

140 mm, 5 1/2"

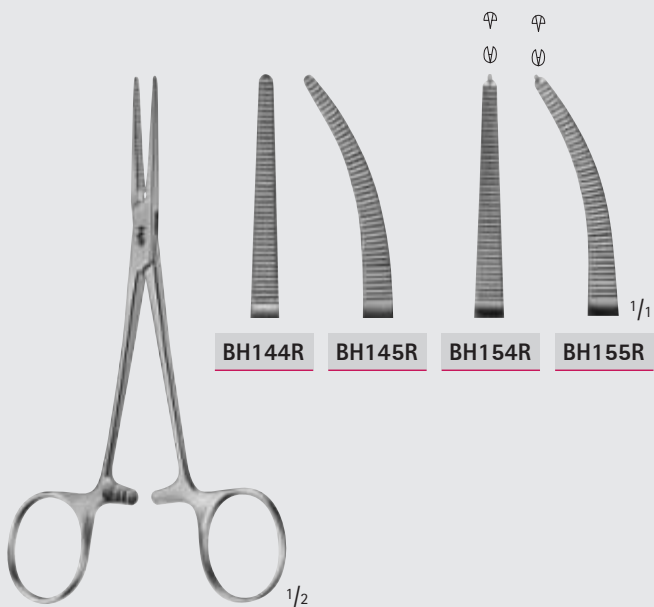

CRILE

**BH144R-BH155R**

140 mm, 5 1/2"



DUNHILL

**BH123R**

125 mm, 5"





## Arterienklemmen – Hemostatic Forceps

### Feine Arterienklemmen

### Delicate Hemostatic Forceps

**BH**



CAIRNS

**BH124R-BH125R**

150 mm, 6"

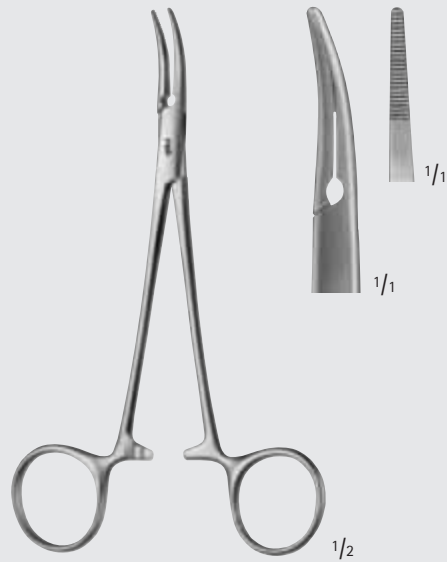

CAIRNS

**BH126R**

seitwärts gebogen  
curved to side  
145 mm, 5 3/4"

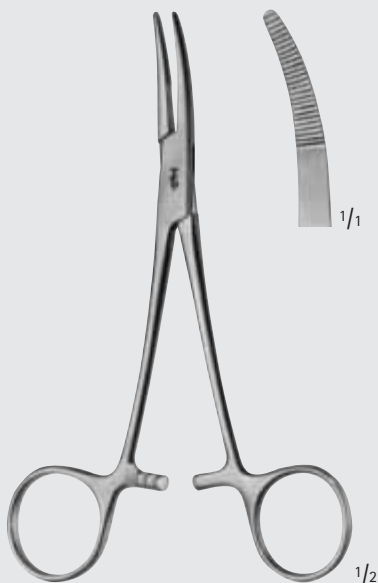

MOYNIHAN

**BH127R**

150 mm, 6"

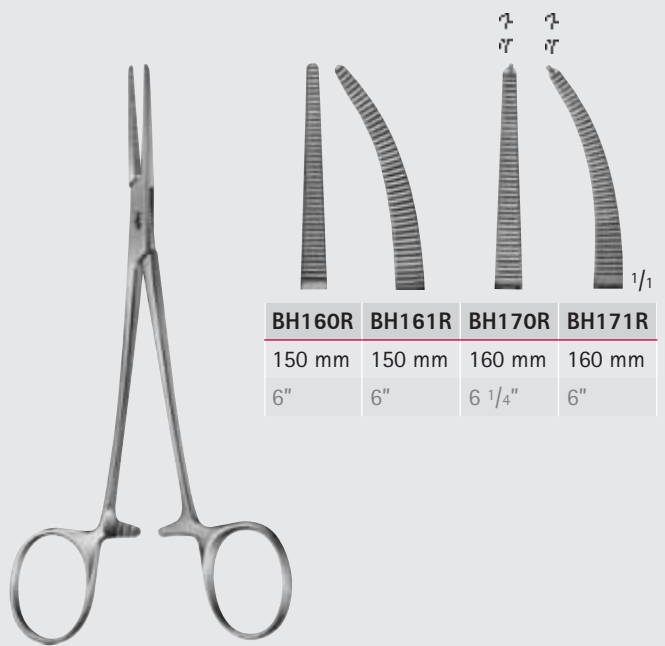

LERICHE

**BH160R-BH171R**

BH160R	BH161R	BH170R	BH171R
150 mm	150 mm	160 mm	160 mm
6"	6"	6 1/4"	6"



MILLIMETERS

## Arterienklemmen – Hemostatic Forceps

Feine Arterienklemmen

Delicate Hemostatic Forceps

BH

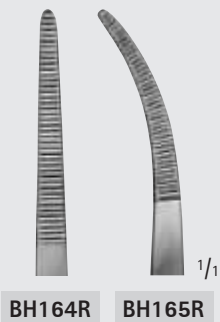

BH164R

BH165R

1/2

RANKIN

BH164R-BH165R

160 mm, 6 1/4"

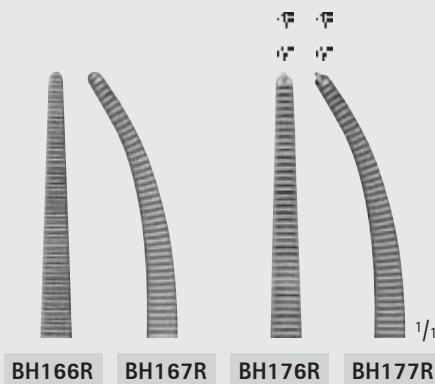

BH166R

BH167R

BH176R

BH177R

1/2

CRILE

BH166R-BH177R

160 mm, 6 1/4"



MD464

140 mm

5 1/2"

MD466R

165 mm

6 1/2"

MD468

185 mm

7 1/4"

MD465R

140 mm

5 1/2"

MD467R

165 mm

6 1/2"

MD469

185 mm

7 1/4"

COLLER

MD464-MD469





**Arterienklemmen – Hemostatic Forceps**  
 Feine Arterienklemmen  
 Delicate Hemostatic Forceps

**BH**



**BH168R**

**BH178R**

DIXON-LOVELACE

**BH168R-BH178R**

160 mm, 6 1/4"



1/1

1/2

FUCHSIG

**BH198R**

195 mm, 7 3/4"



1/1

1/2

NISSEN

**BH199R**

185 mm, 7 1/4"



**BH200R**

**BH201R**

ADSON

**BH200R-BH201R**

185 mm, 7 1/4"

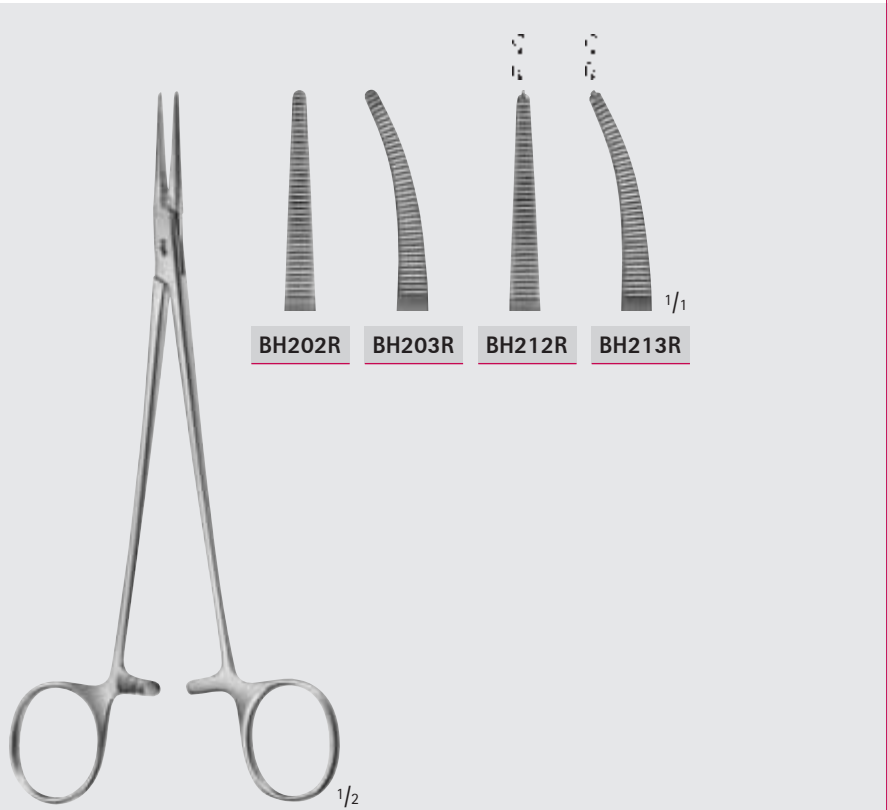

**BH202R**

**BH203R**

**BH212R**

**BH213R**

1/1

1/2

HALSTED

**BH202R-BH213R**

185 mm, 7 1/4"

MILLIMETERS

## Arterienklemmen – Hemostatic Forceps

Feine Arterienklemmen

Delicate Hemostatic Forceps

BH

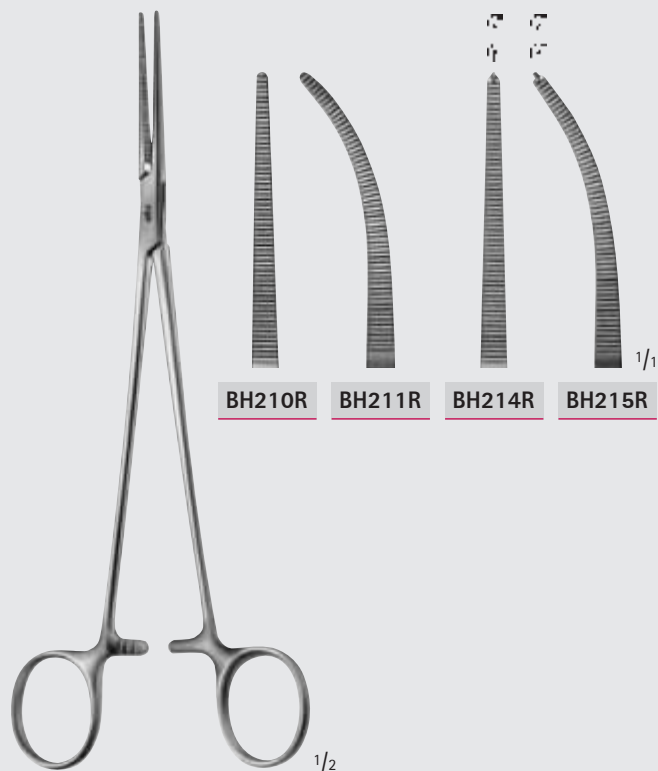

HALSTED-MOSQUITO

**BH210R-BH215R**

200 mm, 8"



JACOBSON

**BH187R**

190 mm, 7 1/2"



ADSON

**BH205R**

215 mm, 8 1/2"



FRASER-KELLY (CRILE)

**BH183R**

180 mm, 7"



## Arterienklemmen – Hemostatic Forceps

Feine Arterienklemmen  
Delicate Hemostatic Forceps

**BH**



DUNHILL

**BH191R**

190 mm, 7 1/2"

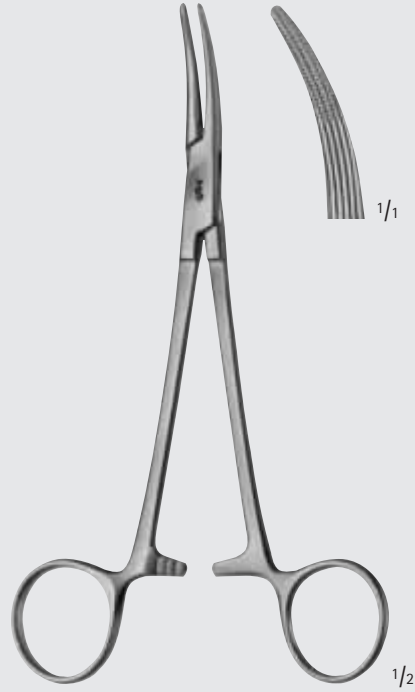

GREY-TURNER

**BH193R**

180 mm, 7"

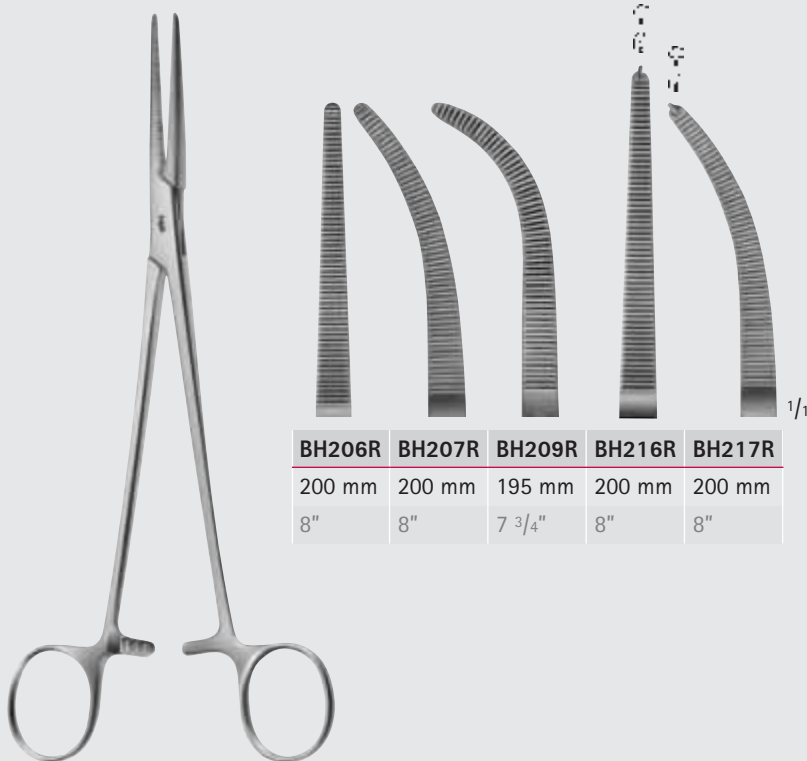

BH206R	BH207R	BH209R	BH216R	BH217R
200 mm	200 mm	195 mm	200 mm	200 mm
8"	8"	7 3/4"	8"	8"

HEISS

**BH206R-BH217R**



MILLIMETERS

## Arterienklemmen – Hemostatic Forceps

Feine Arterienklemmen

Delicate Hemostatic Forceps

BH

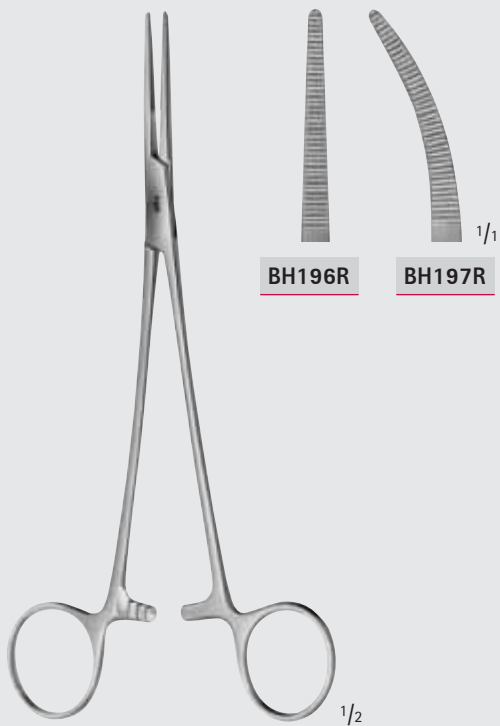
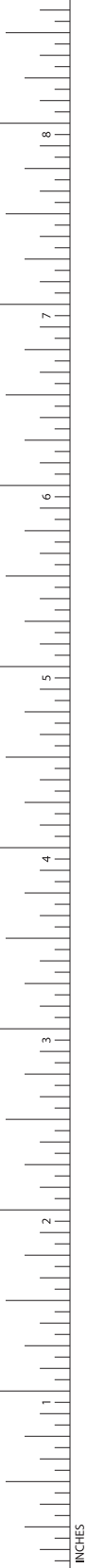

BIRKETT

**BH196R-BH197R**

185 mm, 7 1/4"

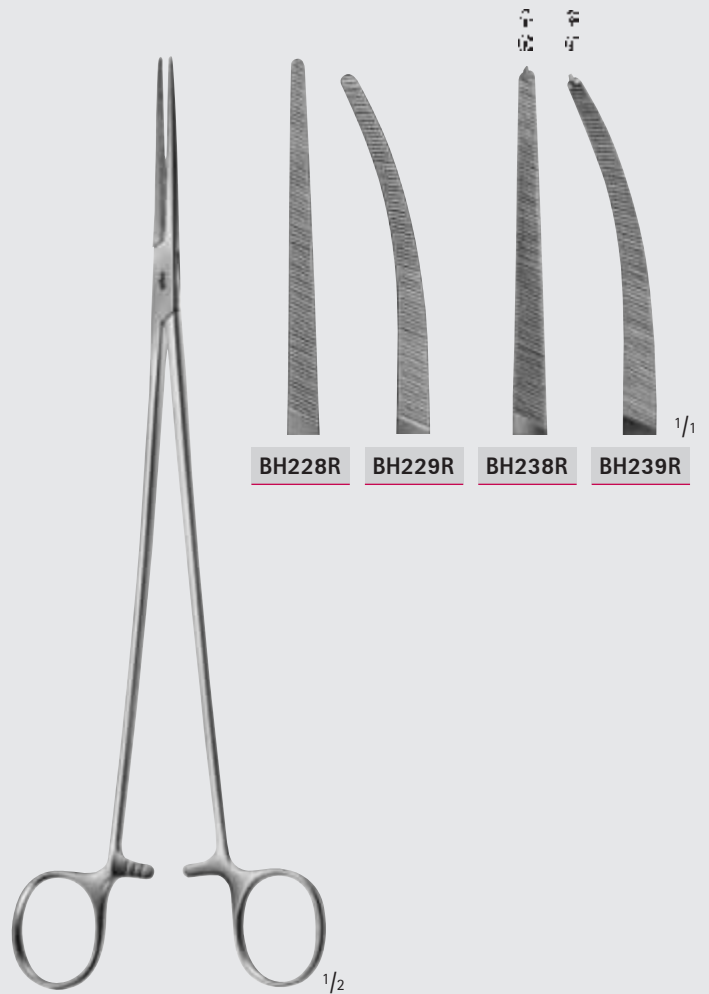

BENGOLEA

**BH228R-BH239R**

245 mm, 9 3/4"





## Arterienklemmen – Hemostatic Forceps

Feine Arterienklemmen  
Delicate Hemostatic Forceps

BH



BH224R

BH234R

SAROT

BH224R-BH234R

240 mm, 9 1/2"



1/1

CRAFOORD

BH225R

245 mm, 9 3/4"

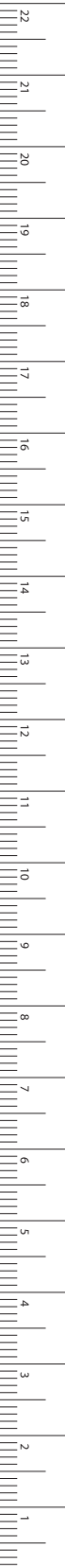

## Arterienklemmen – Hemostatic Forceps

Feine Arterienklemmen

Delicate Hemostatic Forceps

BH



CRAFOORD, MOD.

**BH227R**

240 mm, 9 1/2"

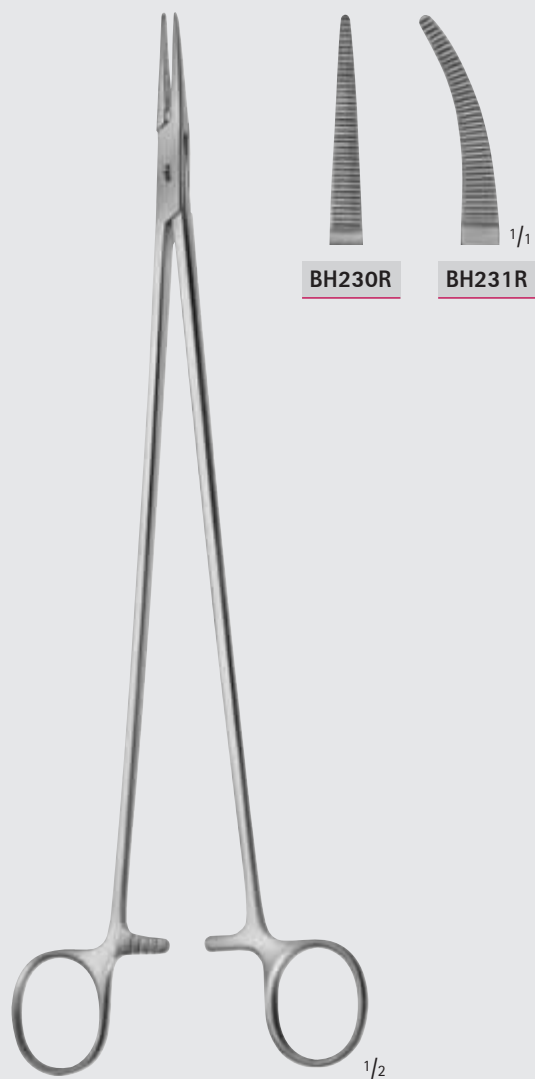

BRIDGE

**BH230R-BH231R**

275 mm, 10 3/4"



**Arterienklemmen – Hemostatic Forceps**  
 Arterienklemmen  
 Hemostatic Forceps

**BH**

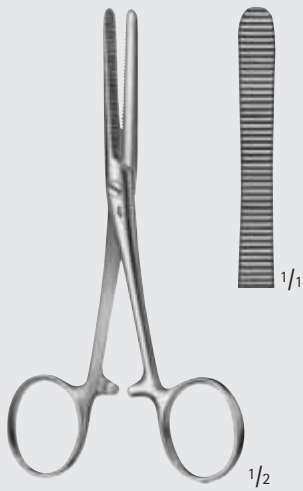
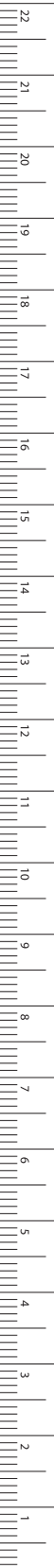

PEAN

**BH410R**

125 mm, 5"



KRÖNLEIN

**BH300R**

130 mm, 5 1/8"



BH302R	BH304R
125 mm	140 mm
5"	5 1/2"

PEAN

**BH302R-BH304R**



PEAN

**BH312R**

125 mm, 5"



BH316R	BH318R
165 mm	185 mm
6 1/2"	7 1/4"

PEAN

**BH316R-BH318R**

## Arterienklemmen – Hemostatic Forceps

Arterienklemmen

Hemostatic Forceps

BH

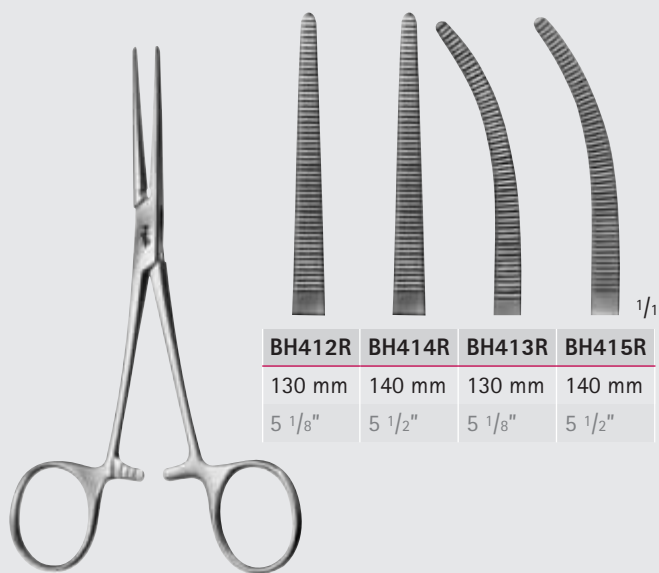

BH412R	BH414R	BH413R	BH415R
130 mm	140 mm	130 mm	140 mm
5 1/8"	5 1/2"	5 1/8"	5 1/2"

PEAN

**BH412R-BH415R**

grazile Form  
slender type



BH422R	BH424R	BH425R
130 mm	140 mm	140 mm
5 1/8"	5 1/2"	5 1/2"

PEAN

**BH422R-BH425R**

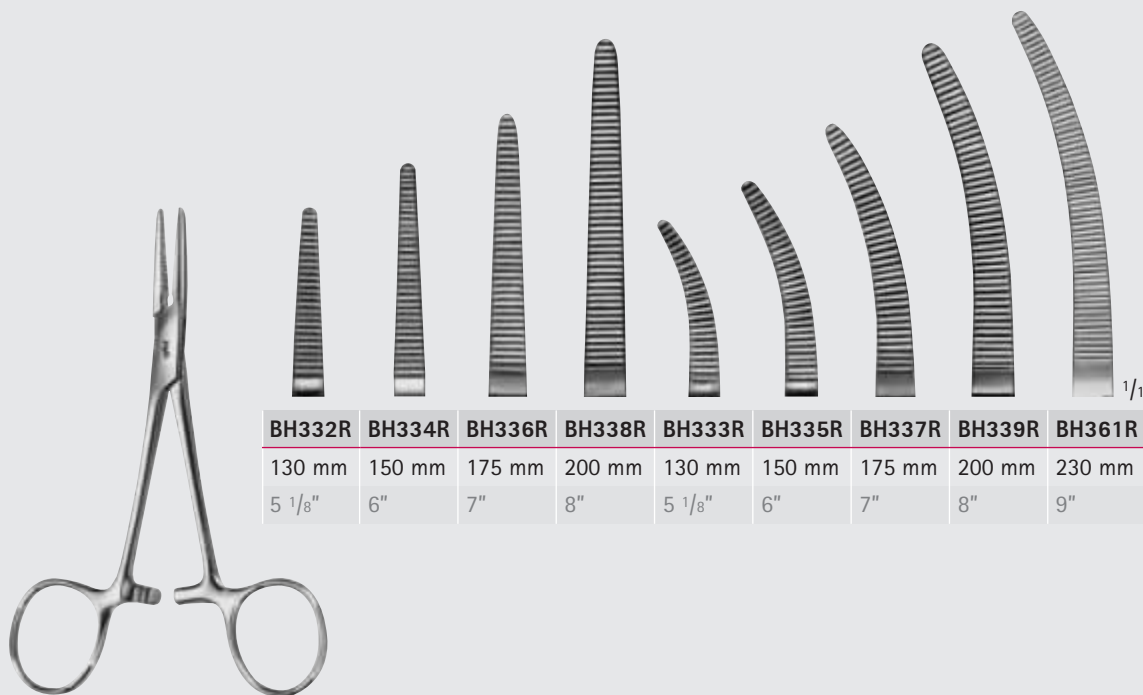

BH332R	BH334R	BH336R	BH338R	BH333R	BH335R	BH337R	BH339R	BH361R
130 mm	150 mm	175 mm	200 mm	130 mm	150 mm	175 mm	200 mm	230 mm
5 1/8"	6"	7"	8"	5 1/8"	6"	7"	8"	9"

SPENCER-WELLS

**BH332R-BH361R**



# Arterienklemmen – Hemostatic Forceps

Arterienklemmen  
Hemostatic Forceps

**BH**

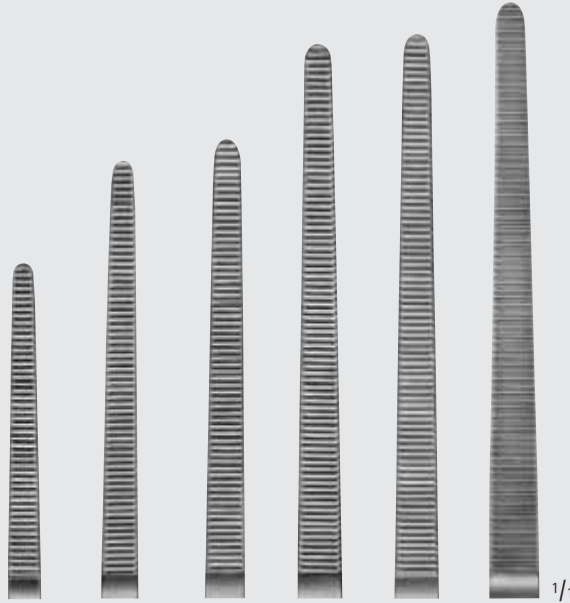

BH442R	BH444R	BH446R	BH448R	BH450R	BH456R
160 mm	185 mm	200 mm	225 mm	240 mm	350 mm
6 1/4"	7 1/4"	8"	9"	9 1/2"	14"

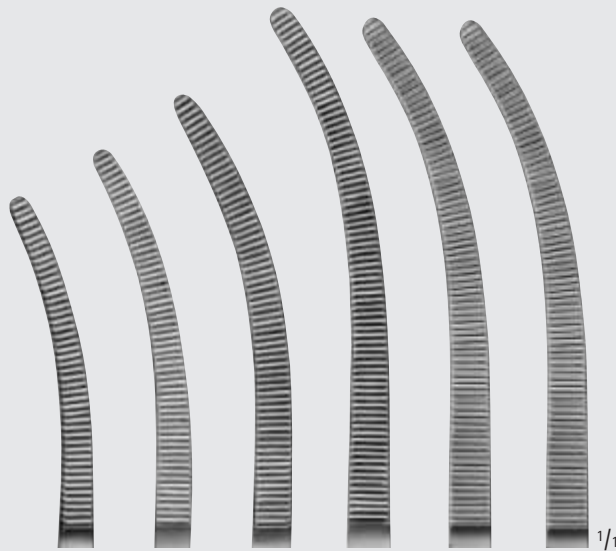

BH443R	BH445R	BH447R	BH449R	BH451R	BH457R
160 mm	185 mm	200 mm	225 mm	240 mm	350 mm
6 1/4"	7 1/4"	8"	9"	9 1/2"	14"



ROCHESTER-PEAN  
BH442R-BH457R

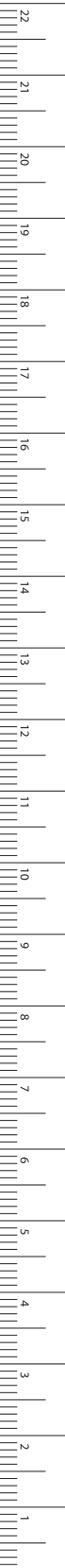

MILLIMETERS

# Arterienklemmen – Hemostatic Forceps

Arterienklemmen

Hemostatic Forceps

BH



PEAN

BH470R-BH475R

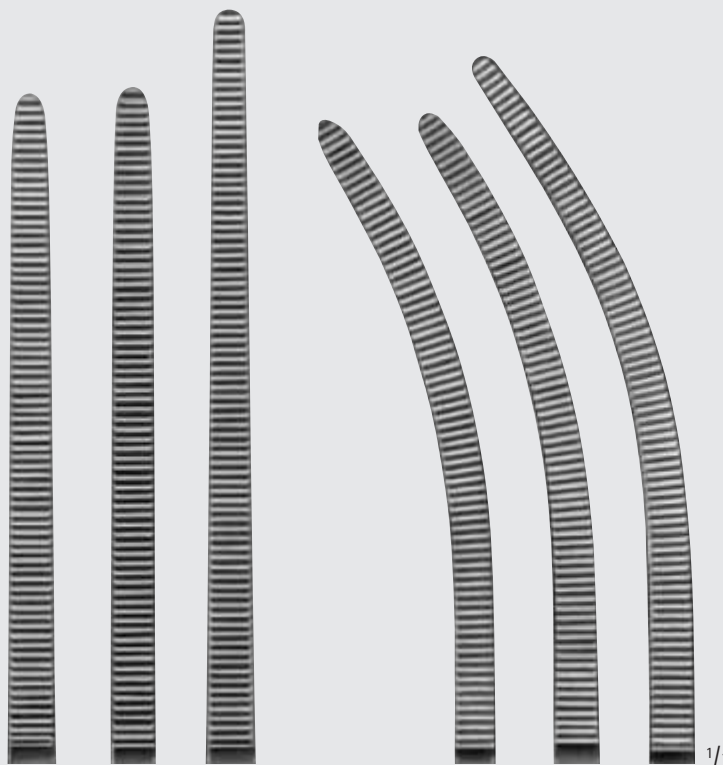

BH470R	BH472R	BH474R
240 mm	260 mm	280 mm
9 1/2"	10 1/4"	11"

BH471R	BH473R	BH475R
240 mm	260 mm	280 mm
9 1/2"	10 1/4"	11"



## Arterienklemmen – Hemostatic Forceps

Arterienklemmen  
Hemostatic Forceps

**BH**



KOCHER

**BH610R**

kräftiges Modell  
strong pattern  
145 mm, 5 3/4"

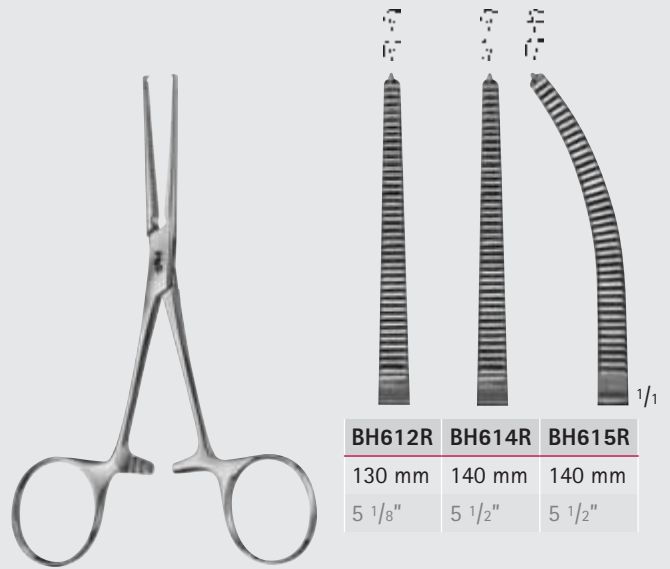

KOCHER

**BH612R-BH615R**

BH612R	BH614R	BH615R
130 mm	140 mm	140 mm
5 1/8"	5 1/2"	5 1/2"

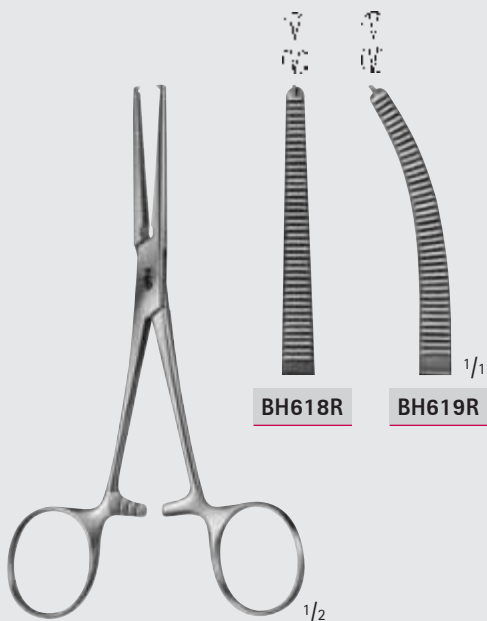

ROCHESTER-OCHSNER

**BH618R-BH619R**

140 mm, 5 1/2"



KOCHER

**BH630R-BH631R**

150 mm, 6"

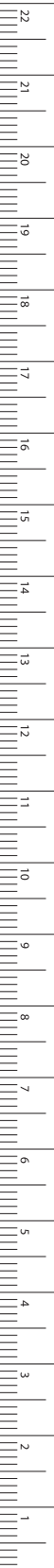

MILLIMETERS

# Arterienklemmen – Hemostatic Forceps

Arterienklemmen

Hemostatic Forceps

BH

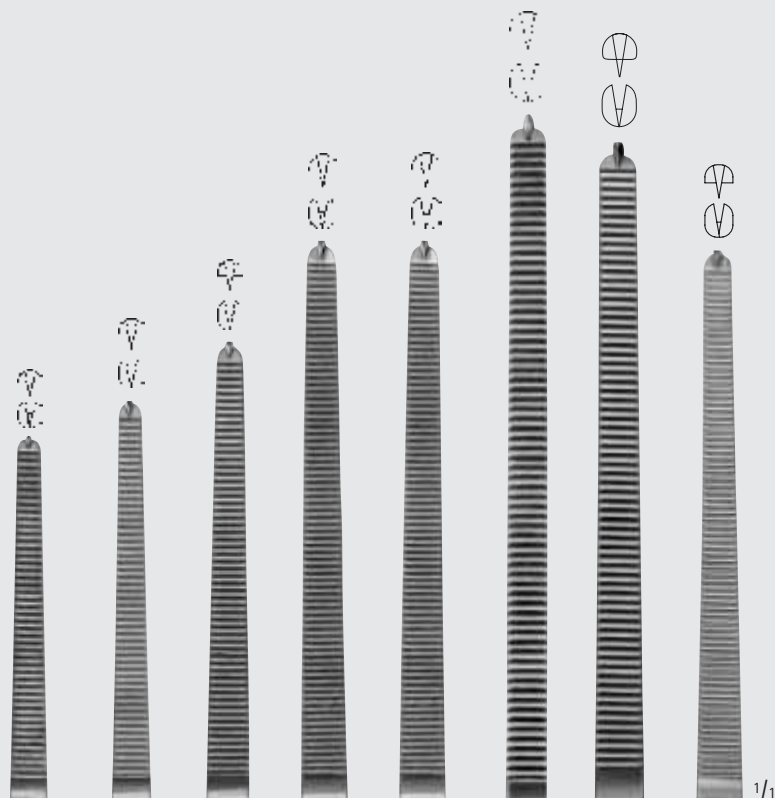
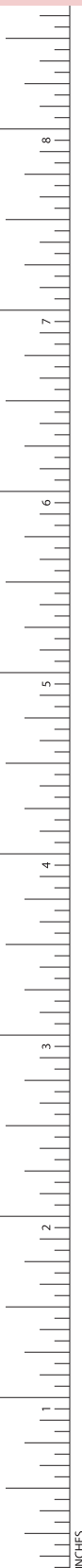

BH642R	BH644R	BH646R	BH648R	BH650R	BH652R	BH654R	BH658R
160 mm	185 mm	200 mm	225 mm	240 mm	260 mm	280 mm	350 mm
6 1/4"	7 1/4"	8"	9"	9 1/2"	10 1/4"	11"	14"



KOCHER-OCHSNER

**BH642R-BH659R**

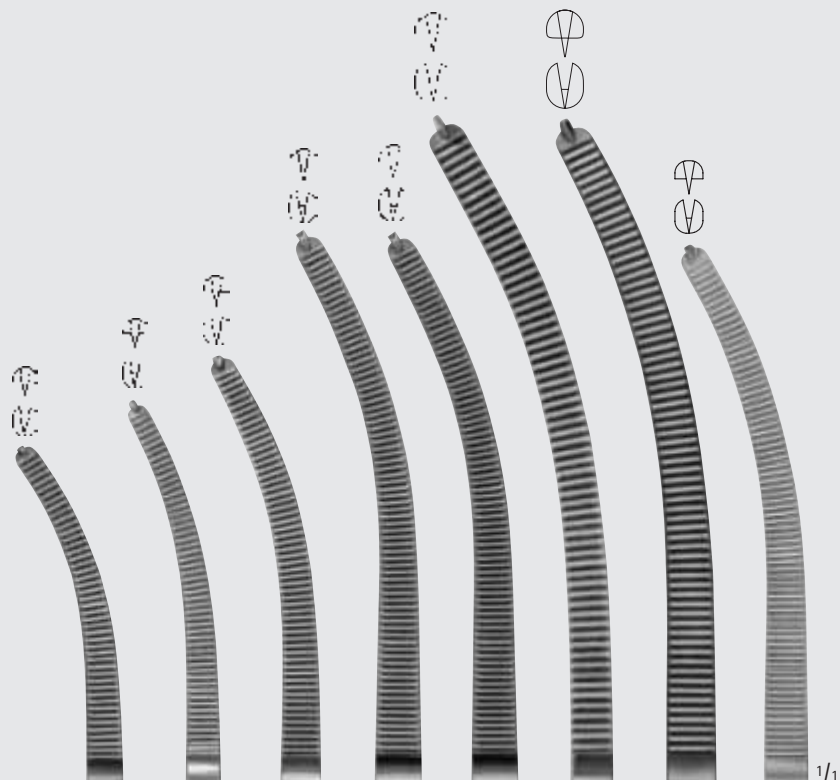

BH643R	BH645R	BH647R	BH649R	BH651R	BH653R	BH655R	BH659R
160 mm	185 mm	200 mm	225 mm	240 mm	260 mm	280 mm	350 mm
6 1/4"	7 1/4"	8"	9"	9 1/2"	10 1/4"	11"	14"





## Arterienklemmen – Hemostatic Forceps

Arterienklemmen, Spezial-Modelle  
Hemostatic Forceps, Special Patterns

BH

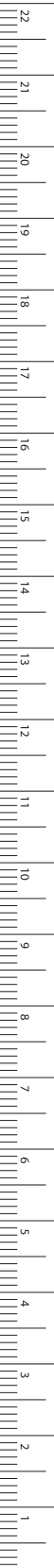

MILLIMETERS

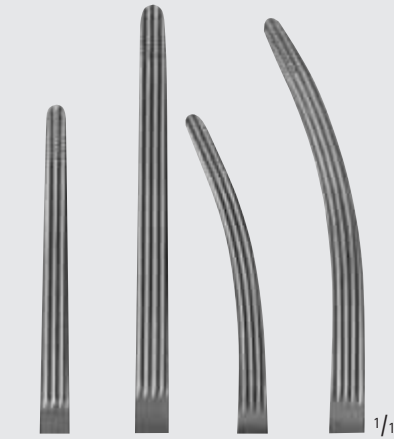

BH800R	BH804R	BH801R	BH805R
160 mm	200 mm	160 mm	200 mm
6 1/4"	8"	6 1/4"	8"

ROCHESTER-CARMALT

**BH800R-BH805R**



**BH807R**

**BH808R**

1 x 2 Zähne  
1 x 2 teeth

FICKLING

**BH807R-BH808R**

180 mm, 7"

## Arterienklemmen – Hemostatic Forceps

Arterienklemmen, Spezial-Modelle

Hemostatic Forceps, Special Patterns

BH

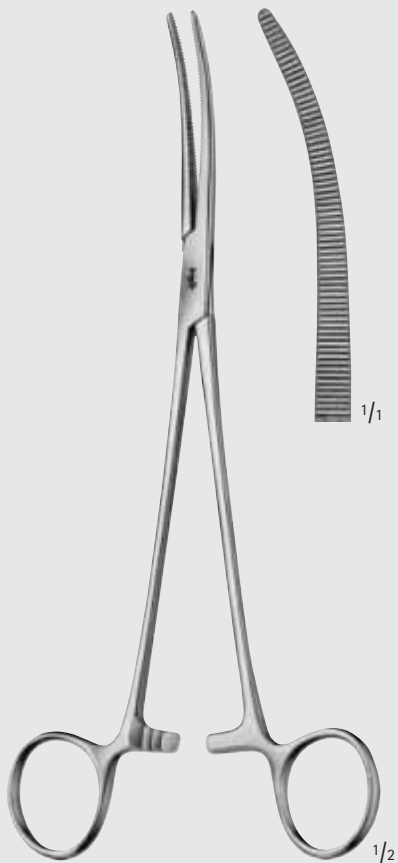

ROBERTS

**BH814R**

225 mm, 9"



ROBERTS

**BH812R-BH813R**

250 mm, 10"



SAROT

**BH226R**

250 mm, 9 3/4"



## Arterienklemmen – Hemostatic Forceps

Arterienklemmen, Spezial-Modelle  
Hemostatic Forceps, Special Patterns

**BH**

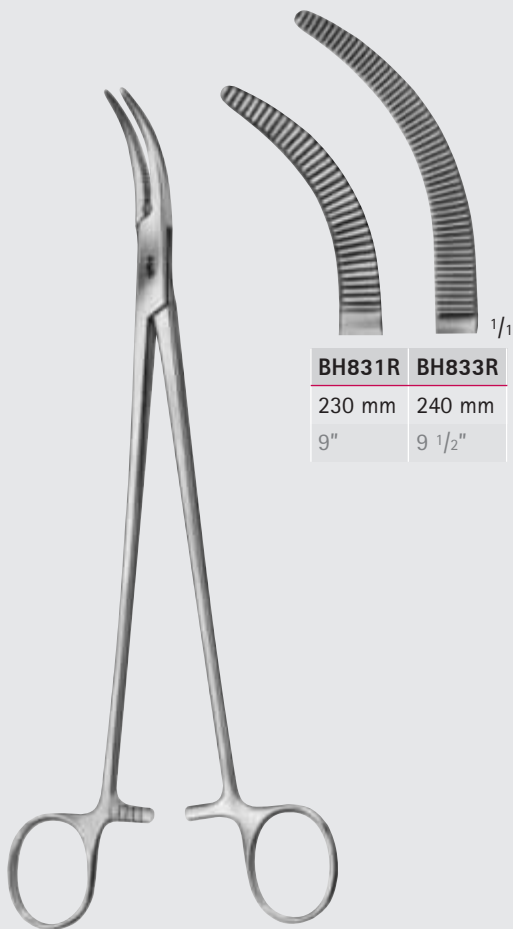

BH831R	BH833R
230 mm	240 mm
9"	9 1/2"

MOYNIHAN

**BH831R-BH833R**

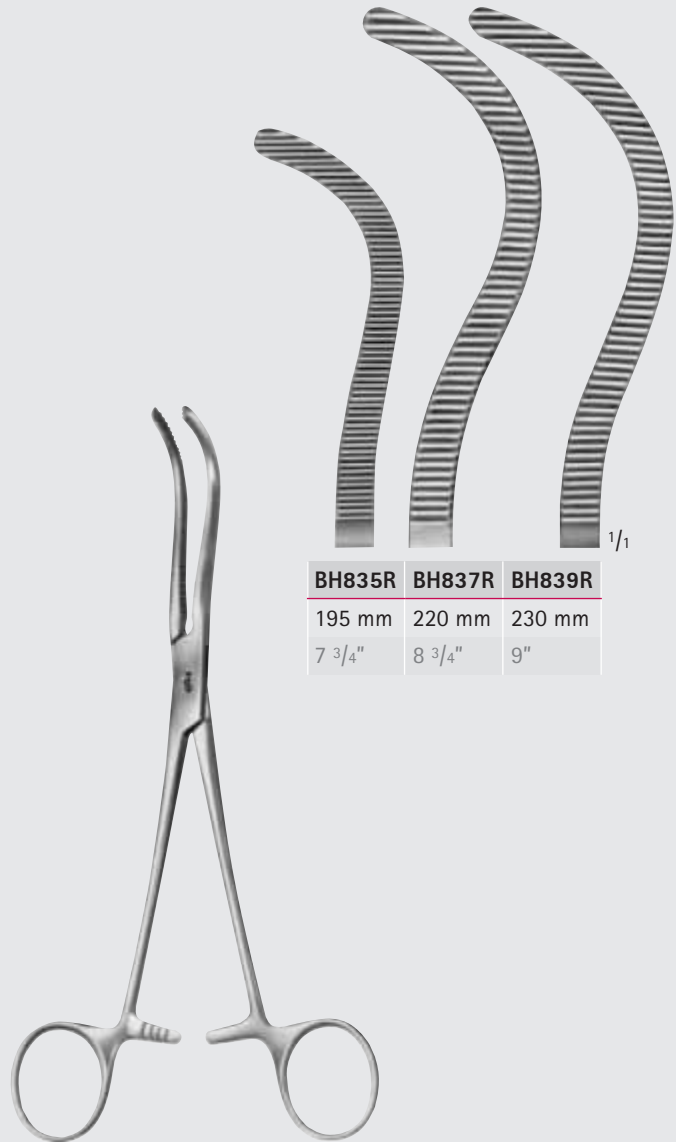

BH835R	BH837R	BH839R
195 mm	220 mm	230 mm
7 3/4"	8 3/4"	9"

PEAN

**BH835R-BH839R**

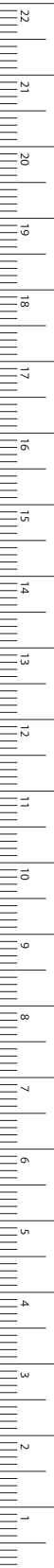

MILLIMETERS

## Arterienklemmen – Hemostatic Forceps

Arterienklemmen, Tonsillenklemmen

Hemostatic Forceps, Tonsil Forceps

BH



**BH957R** **BH959R**

SCHNIDT

**BH957R-BH959R**

185 mm, 7 1/4"



**BH961R** **BH963R**

SCHNIDT

**BH961R-BH963R**

185 mm, 7 1/4"



**BH951R** **BH952R**

NEGUS

**BH951R-BH952R**

190 mm, 7 1/2"

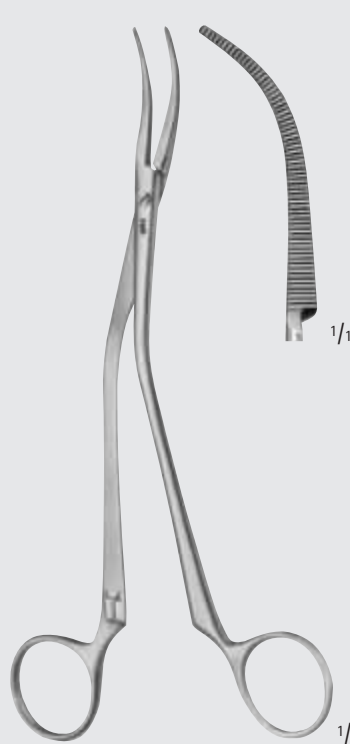

WILSON

**BH965R**

190 mm, 7 1/2"

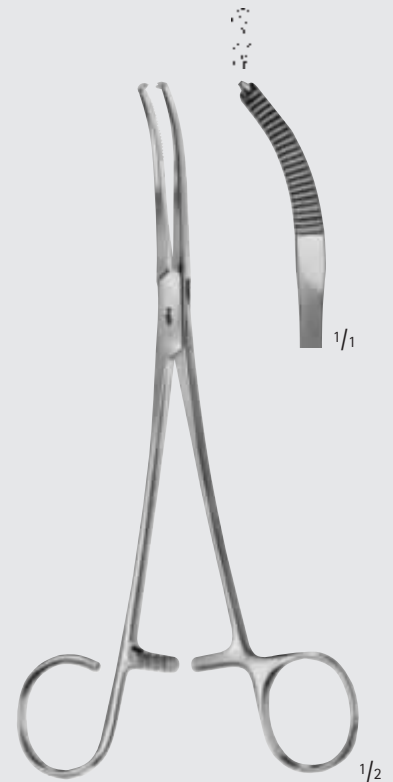

MIKULICZ

**BH949R**

185 mm, 7 1/4"



## Arterienklemmen – Hemostatic Forceps

Arterienklemmen, Spezial-Modelle  
Hemostatic Forceps, Special Patterns

BH

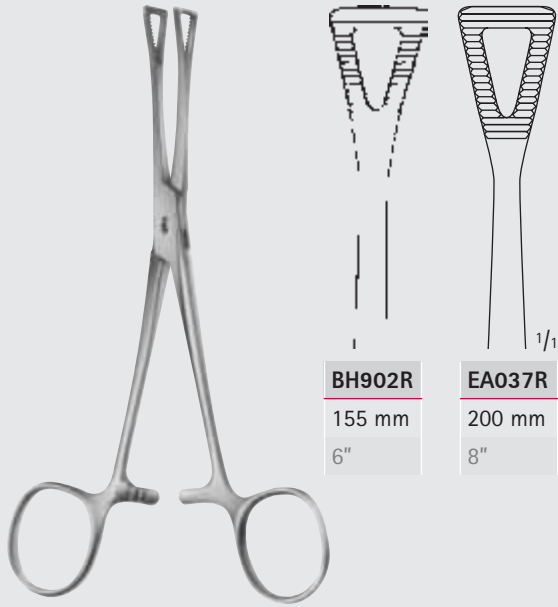
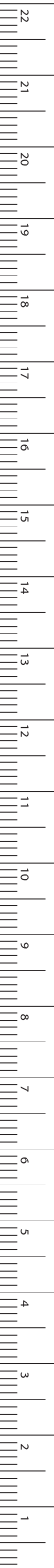

**BH902R**  
155 mm  
6"

**EA037R**  
200 mm  
8"

PENNINGTON

**BH902R-EA037R**

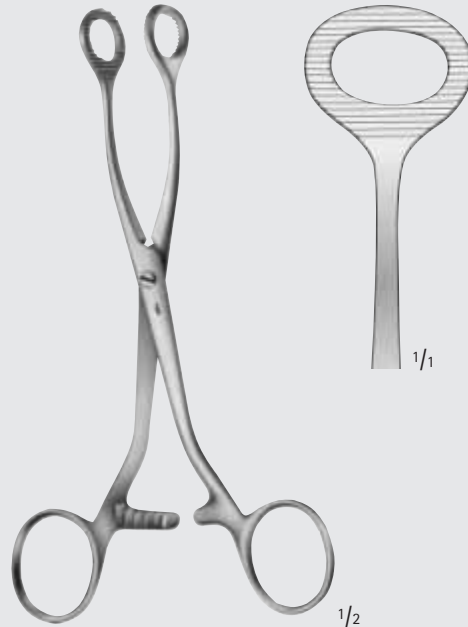

1/1

1/2

COLLIN

**BH906R**

160 mm, 6 1/4"

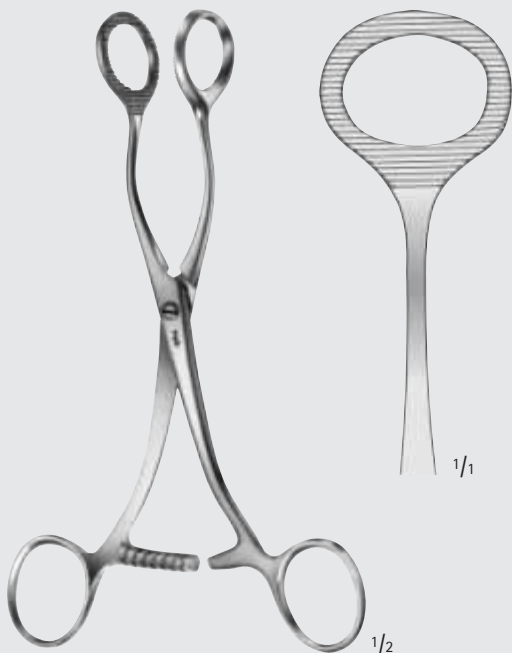

1/1

1/2

COLLIN

**AN709R**

170 mm, 6 3/4"

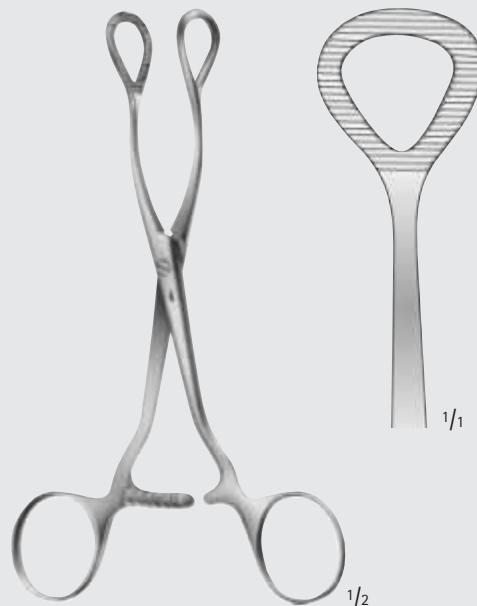

1/1

1/2

COLLIN

**BH908R**

160 mm, 6 1/4"

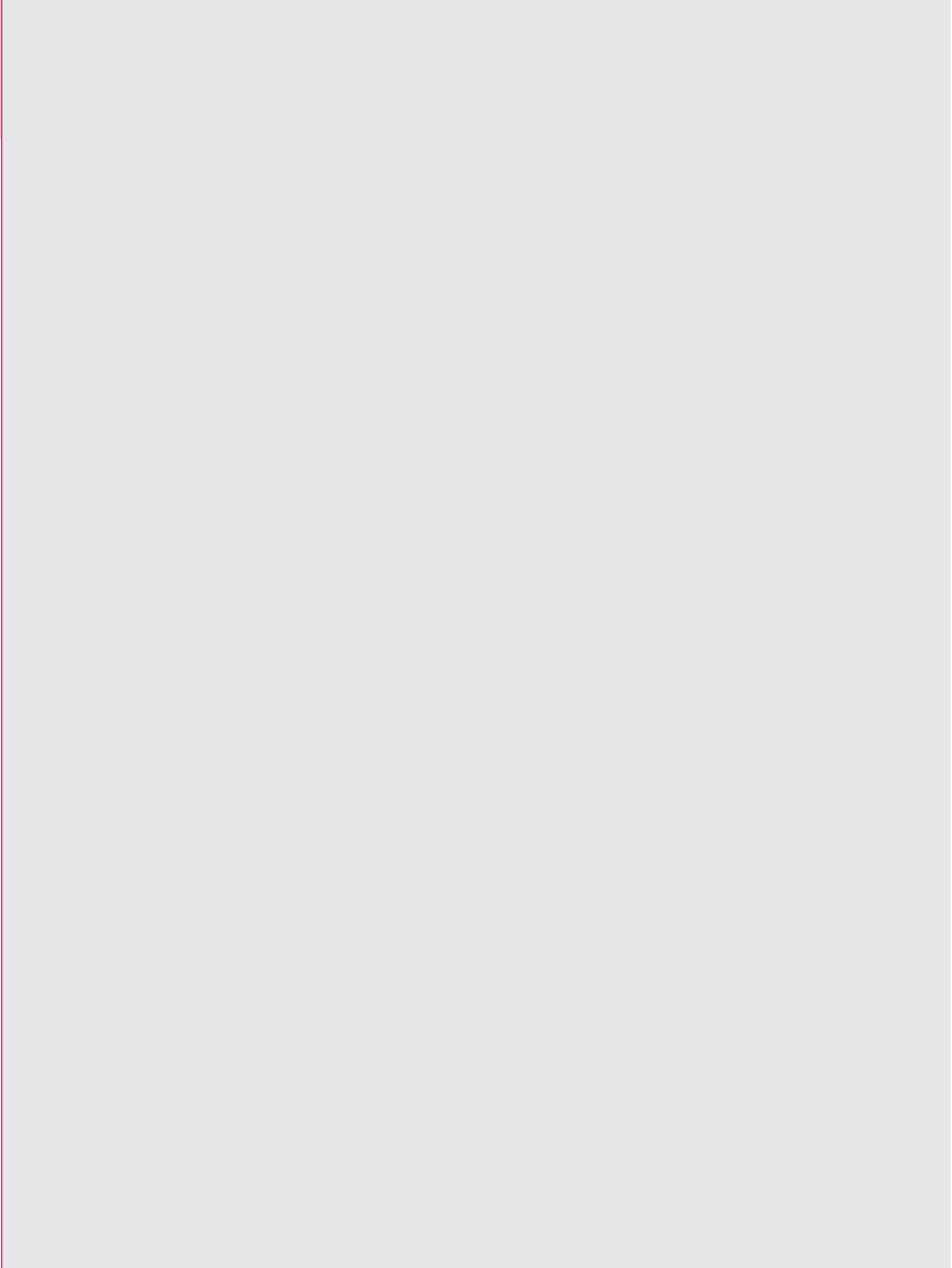

BJ



Präparier- und Ligaturklemmen,  
Hysterektomieklemmen

Dissecting- and Ligature Forceps,  
Hysterectomy Clamps

**Klemmen – Forceps**  
 Präparier- und Ligaturklemmen  
 Dissecting- and Ligature Forceps

**BJ**



**BJ002R**

Ligaturklemme gerade  
 Ligature forceps straight  
 95 mm, 3 3/4"



MICRO-ADSON

**BJ008R**

140 mm, 5 1/2"



BABY-OVERHOLT

**BJ009R**

135 mm, 5 1/4"



BJ011R	BJ012R
140 mm	180 mm
5 1/2"	7"

BABY-MIXTER

**BJ011R-BJ012R**





## Klemmen – Forceps

Präparier- und Ligaturklemmen  
Dissecting- and Ligature Forceps

BJ

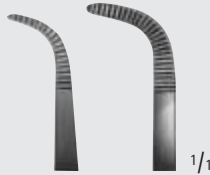
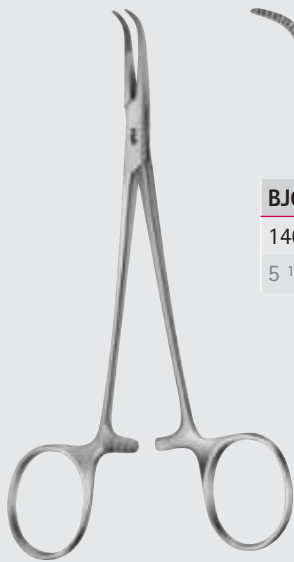

BJ013R	BJ014R
140 mm	180 mm
5 1/2"	7"

BABY-ADSON

**BJ013R-BJ014R**



MD569	MD570R
140 mm	180 mm
5 1/2"	7"

**MD569-MD570R**

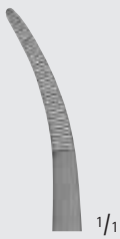
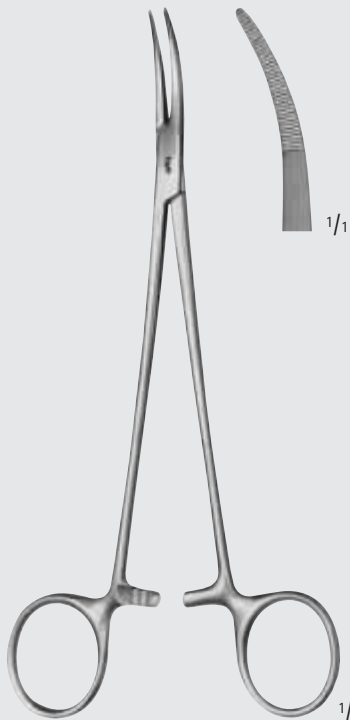

NISSEN

**BH199R**

185 mm, 7 1/4"

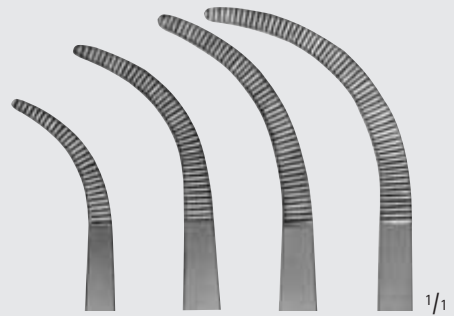
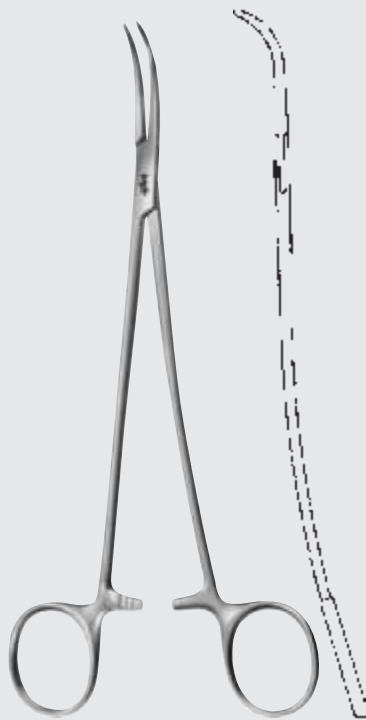

BJ015R	BJ016R	BJ017R	BJ018R
185 mm	210 mm	215 mm	220 mm
7 1/4"	8 1/4"	8 1/2"	8 3/4"

**BJ015R-BJ018R**

S-förmig gebogen, grazil  
S-shaped, delicate

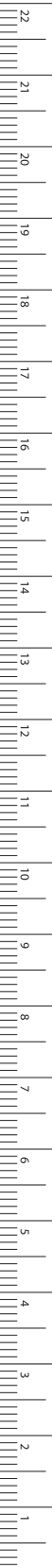

MILLIMETERS

## Klemmen – Forceps

Präparier- und Ligaturklemmen

Dissecting- and Ligature Forceps

BJ

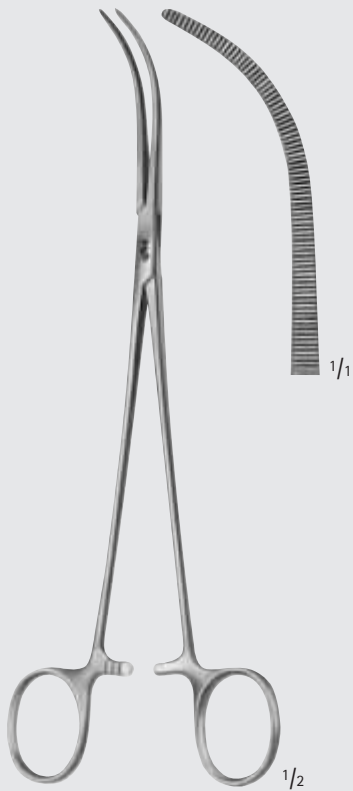

OVERHOLT-MIXTER

**BJ019R**

205 mm, 8"

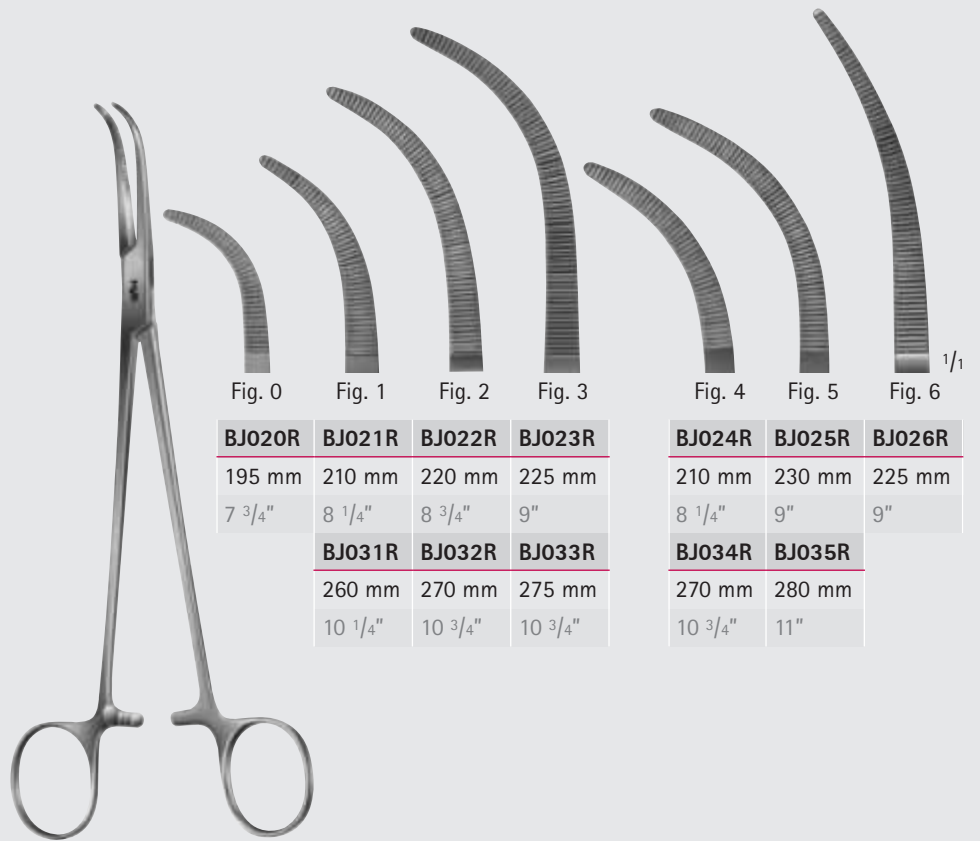

Fig. 0

Fig. 1

Fig. 2

Fig. 3

Fig. 4

Fig. 5

Fig. 6

<b>BJ020R</b>	<b>BJ021R</b>	<b>BJ022R</b>	<b>BJ023R</b>
195 mm	210 mm	220 mm	225 mm
7 3/4"	8 1/4"	8 3/4"	9"

<b>BJ024R</b>	<b>BJ025R</b>	<b>BJ026R</b>
210 mm	230 mm	225 mm
8 1/4"	9"	9"

<b>BJ031R</b>	<b>BJ032R</b>	<b>BJ033R</b>
260 mm	270 mm	275 mm
10 1/4"	10 3/4"	10 3/4"

<b>BJ034R</b>	<b>BJ035R</b>
270 mm	280 mm
10 3/4"	11"

OVERHOLT-GEISSENDOERFER

**BJ020R-BJ035R**



**Klemmen – Forceps**  
 Präparier- und Ligaturklemmen  
 Dissecting- and Ligature Forceps

**BJ**

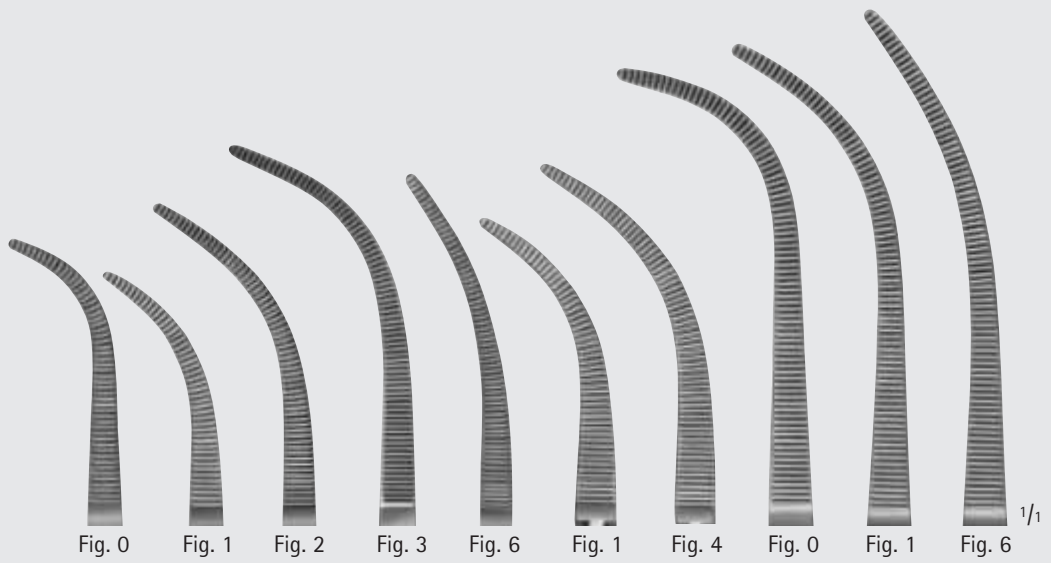
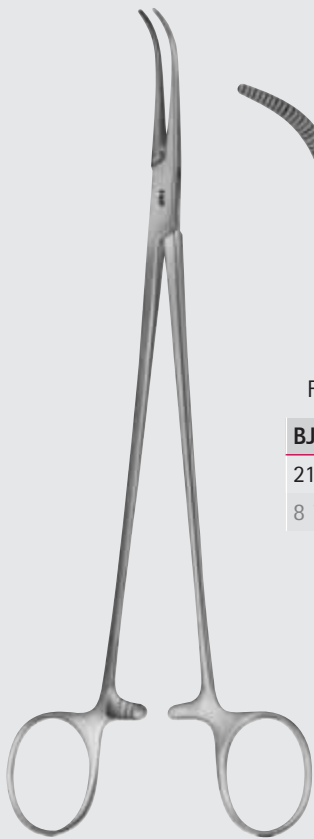
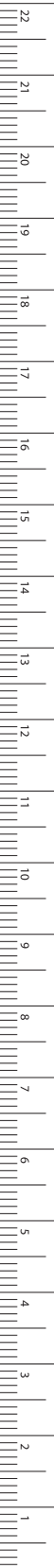

BJ080R	BJ081R	BJ082R	BJ083R	BJ086R	BJ111R	BJ114R	BJ090R	BJ091R	BJ096R
215 mm	210 mm	220 mm	225 mm	225 mm	270 mm	270 mm	295 mm	295 mm	300 mm
8 1/2"	8 1/4"	8 3/4"	9"	9"	10 3/4"	10 3/4"	11 3/4"	11 3/4"	12"

OVERHOLT

**BJ080R-BJ114R**

feine Ausführung  
 delicate pattern

## Klemmen – Forceps

Präparier- und Ligaturklemmen

Dissecting- and Ligature Forceps

BJ

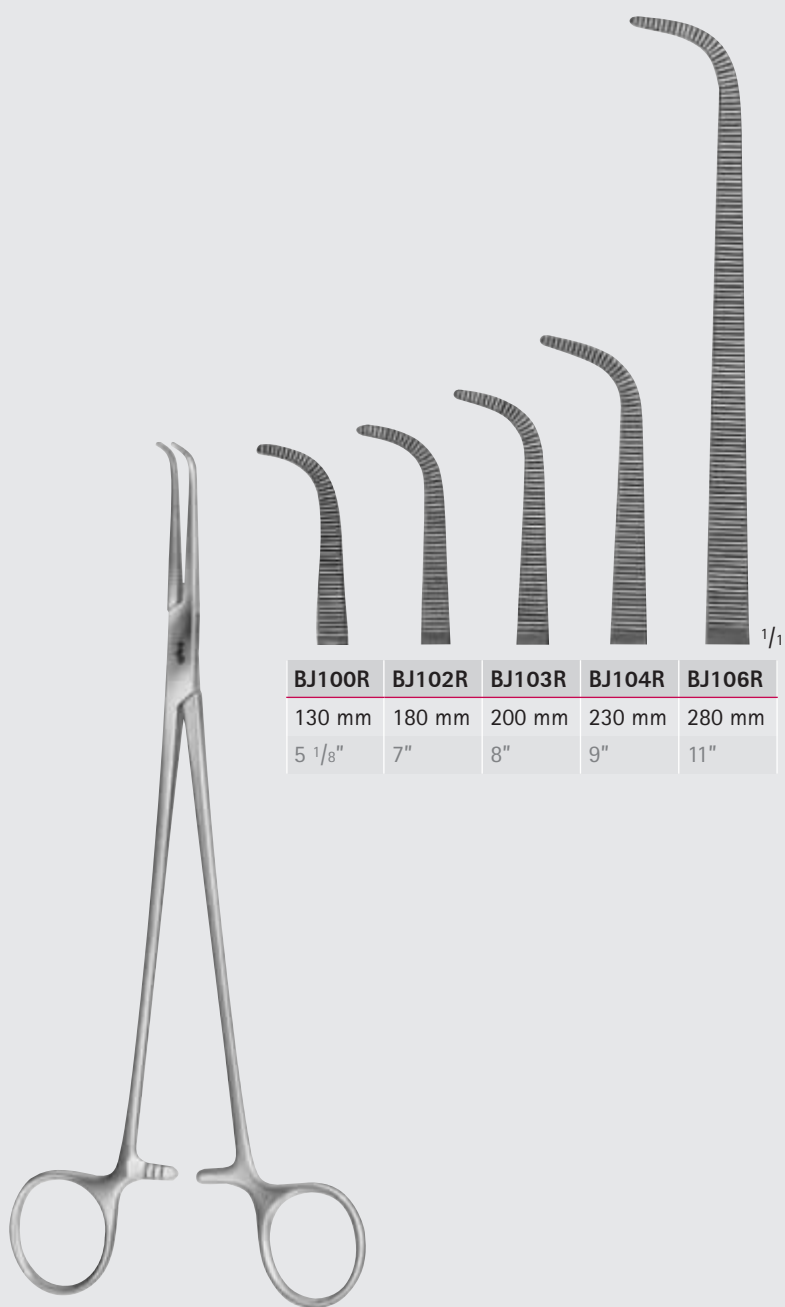

BJ100R	BJ102R	BJ103R	BJ104R	BJ106R
130 mm	180 mm	200 mm	230 mm	280 mm
5 1/8"	7"	8"	9"	11"

GEMINI

BJ100R-BJ106R



**Klemmen – Forceps**  
Präparier- und Ligaturklemmen  
Dissecting- and Ligature Forceps

**BJ**



MIXTER-O'SHAUGNESSY

**BJ050R**

190 mm, 7 1/2"



O'SHAUGNESSY

**BJ067R**

220 mm, 8 3/4"

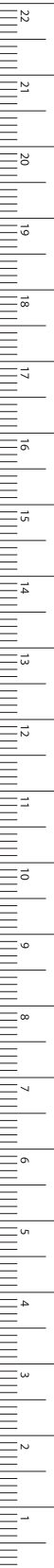

MILLIMETERS

**Klemmen – Forceps**  
Präparier- und Ligaturklemmen  
Dissecting- and Ligature Forceps

**BJ**



HEISS

**BH209R**

195 mm, 7 3/4"



WIKSTROEM

**BJ051R**

205 mm, 8"



**Klemmen – Forceps**  
Präparier- und Ligaturklemmen  
Dissecting- and Ligature Forceps

**BJ**

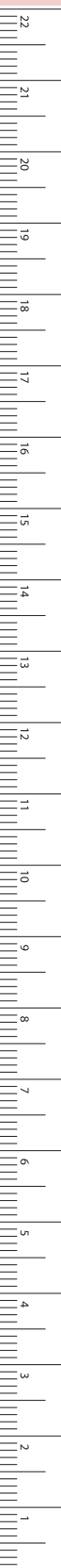

MILLIMETERS



**BJ041R** **BJ042R** **BJ043R** **BJ044R** **BJ045R**

**RUMEL**  
**BJ041R-BJ045R**  
240 mm, 9 1/2"

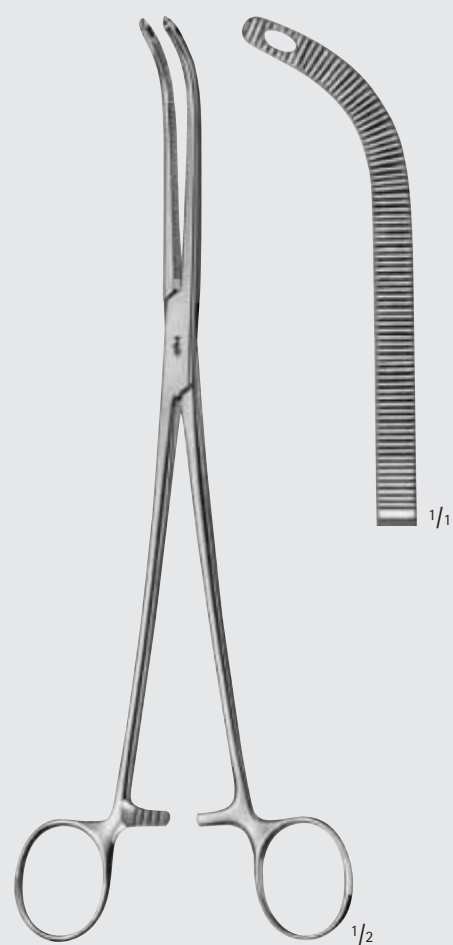

**FINOCHIETTO**  
**BJ052R**  
245 mm, 9 3/4"

## Klemmen – Forceps

Präparier- und Ligaturklemmen

Dissecting- and Ligature Forceps

BJ

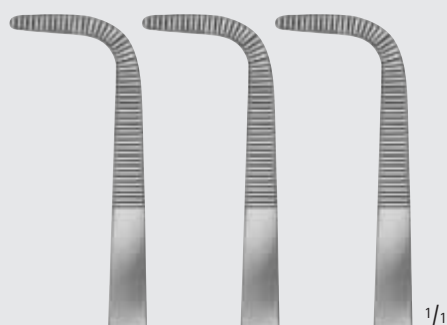

**BJ057R**

200 mm

8"

**BJ058R**

240 mm

9 1/2"

**BJ059R**

275 mm

10 3/4"

KANTROWITZ

**BJ057R-BJ059R**



**BJ029R**

extra fein

extra delicate

**BJ110R**

fein

delicate

BARRE

**BJ029R-BJ110R**

280 mm, 11"

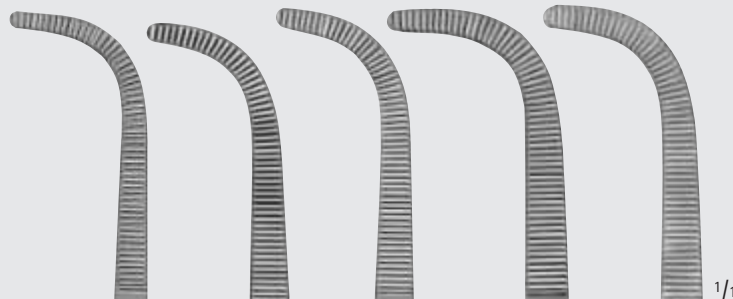

**BJ120R**

150 mm

6"

**BJ121R**

180 mm

7"

**BJ122R**

200 mm

8"

**BJ123R**

230 mm

9"

**BJ124R**

255 mm

10"

O'SHAUGHNESSY

**BJ120R-BJ124R**







**Klemmen – Forceps**  
Präparier- und Ligaturklemmen  
Dissecting- and Ligature Forceps

**BJ**

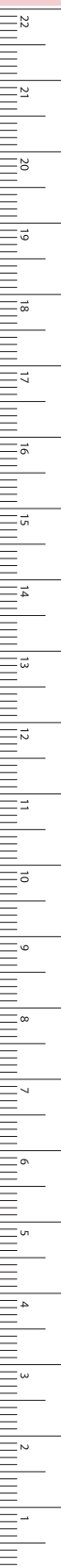

MILLIMETERS

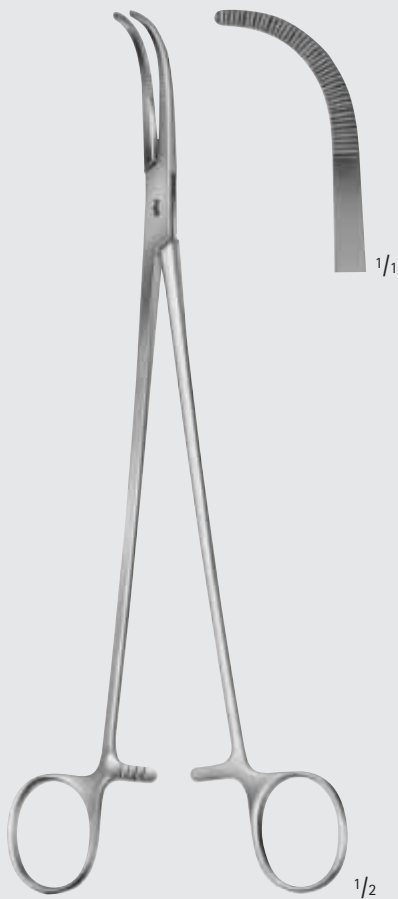

MIXTER

**BJ055R**

230 mm, 9"



LAWRENCE

**BJ070R**

270 mm, 10 3/4"

**Klemmen – Forceps**  
 Präparier- und Ligaturklemmen  
 Dissecting- and Ligature Forceps

**BJ**

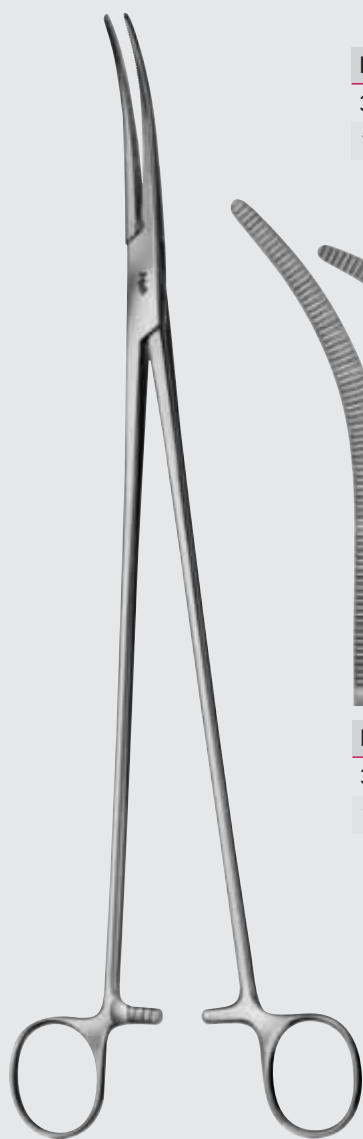

ZENKER

**BJ047R-BJ132R**

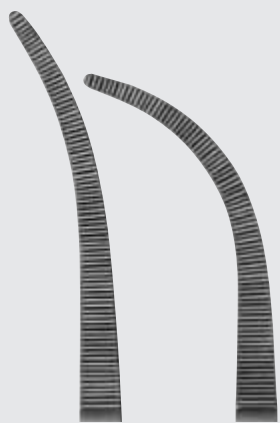

**BJ047R**

300 mm

12"

**BJ048R**

290 mm

11 1/2"

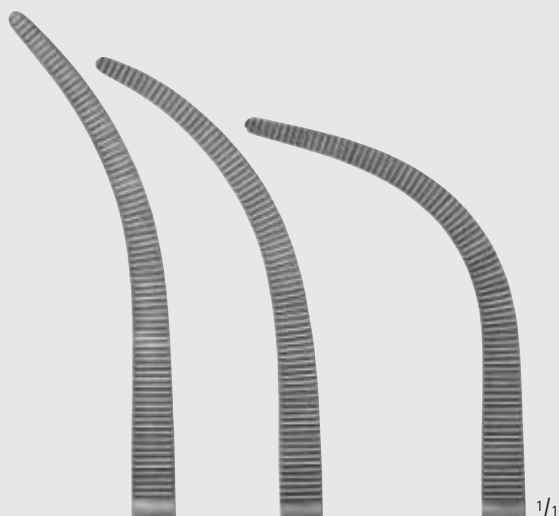

**BJ130R**

350 mm

14"

**BJ131R**

350 mm

14"

**BJ132R**

350 mm

14"

1/1



KIEBACK

**BJ075R-BJ076R**

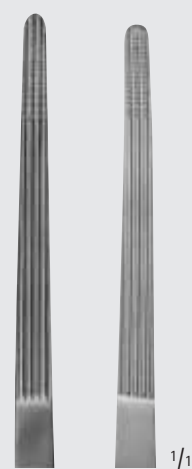

**BJ075R**

235 mm

9 1/4"

**BJ076R**

350 mm

14"

1/1

Ureter-Tunnelier-Klemme, aufgebogen  
 Ureteral tunnel clamp curved on flat



**Klemmen – Forceps**  
 Präparier- und Ligaturklemmen  
 Dissecting- and Ligature Forceps

**BJ**

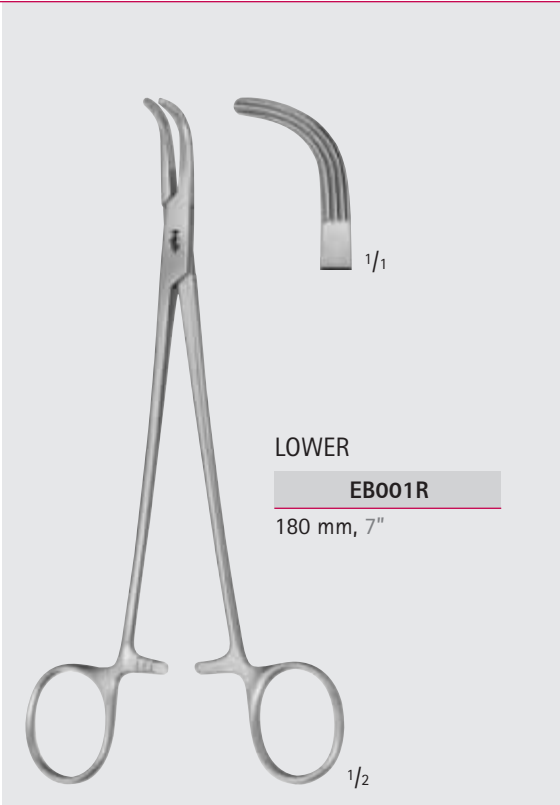

LOWER  
**EB001R**  
 180 mm, 7"

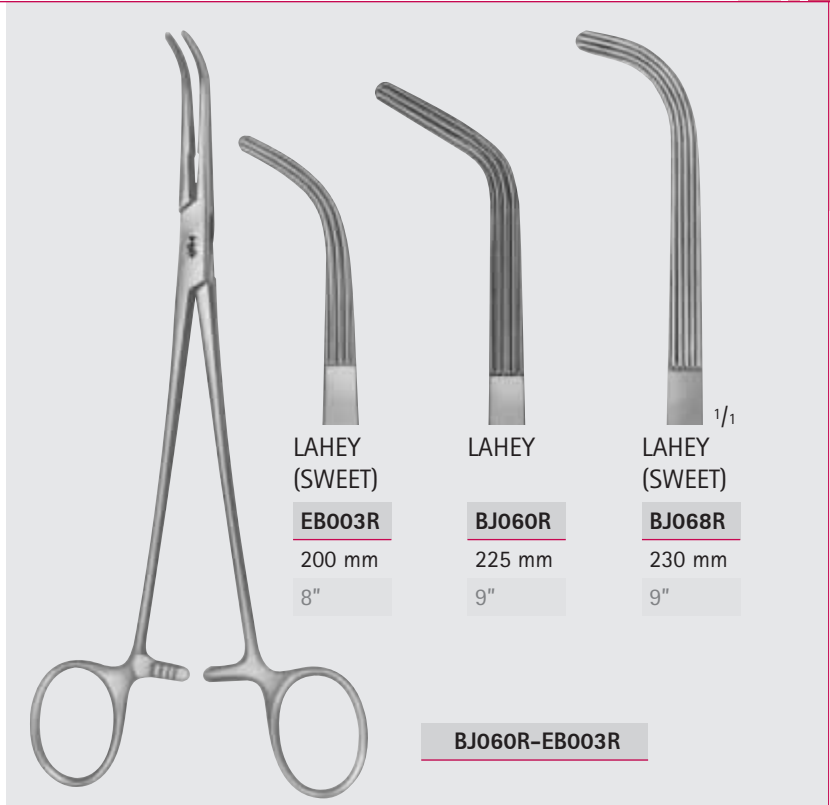

LAHEY (SWEET)  
**EB003R**  
 200 mm  
 8"

LAHEY  
**BJ060R**  
 225 mm  
 9"

LAHEY (SWEET)  
**BJ068R**  
 230 mm  
 9"

**BJ060R-EB003R**



MIXTER  
**BJ061R-BJ073R**

**BJ061R**  
 220 mm  
 8 3/4"

**BJ062R**  
 250 mm  
 10"

**BJ073R**  
 290 mm  
 11 1/2"



MILLIMETERS

## Klemmen – Forceps

Präparier- und Ligaturklemmen

Dissecting- and Ligature Forceps

BJ



DESJARDINS

EBO08R

210 mm, 8 1/4"

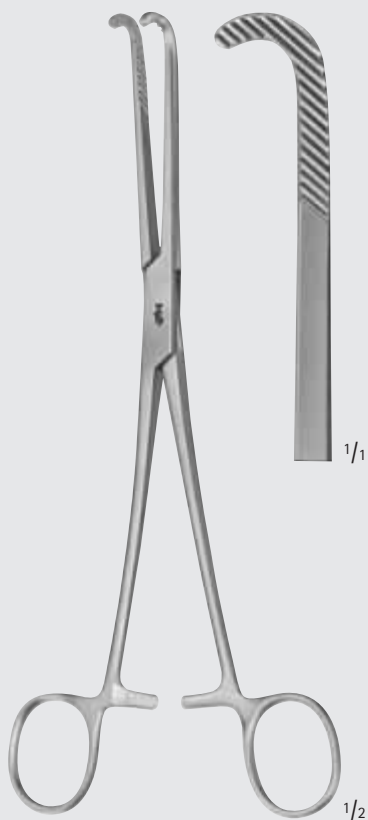

NISSEN

EBO09R

215 mm, 8 1/2"

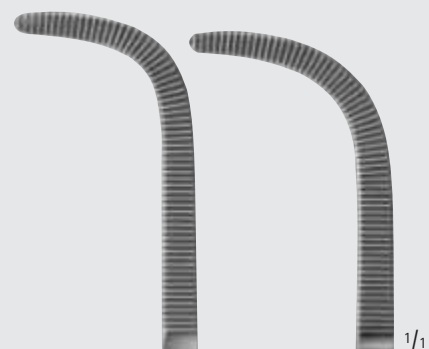

EB011R

EB012R



GRAY

EB011R-EB012R

220 mm, 8 3/4"



**Klemmen – Forceps**  
 Peritoneumklemmen  
 Peritoneum Forceps

**BJ**

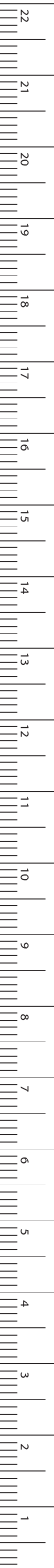

MILLIMETERS



BABY-MIKULICZ

**BJ300R**

140 mm, 5 1/2"



MIKULICZ

**BJ304R**

185 mm, 7 1/4"

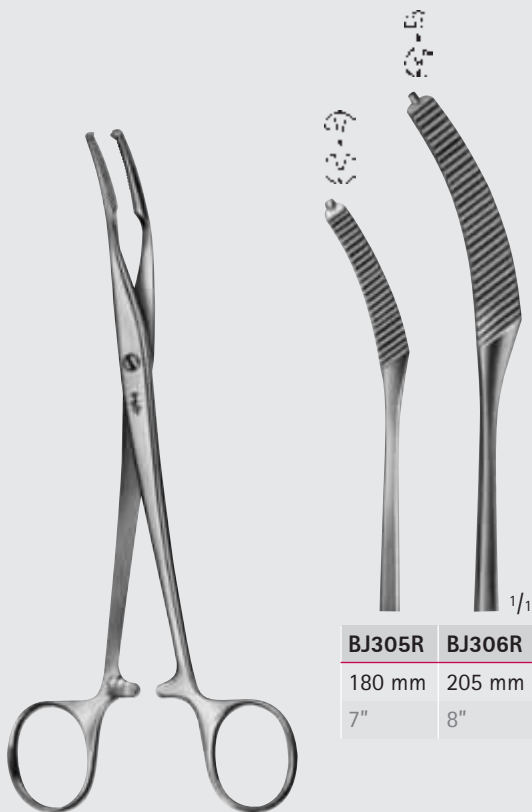

MIKULICZ

**BJ305R-BJ306R**

BJ305R	BJ306R
180 mm	205 mm
7"	8"

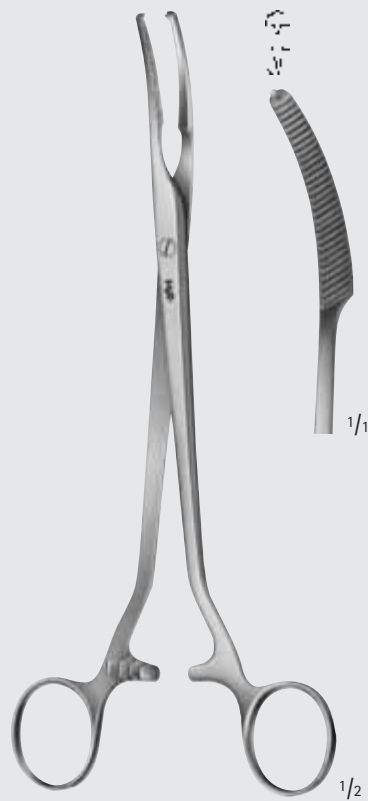

MIKULICZ

**BJ308R**

205 mm, 8"

## Klemmen – Forceps

Peritoneumklemmen

Peritoneum Forceps

BJ

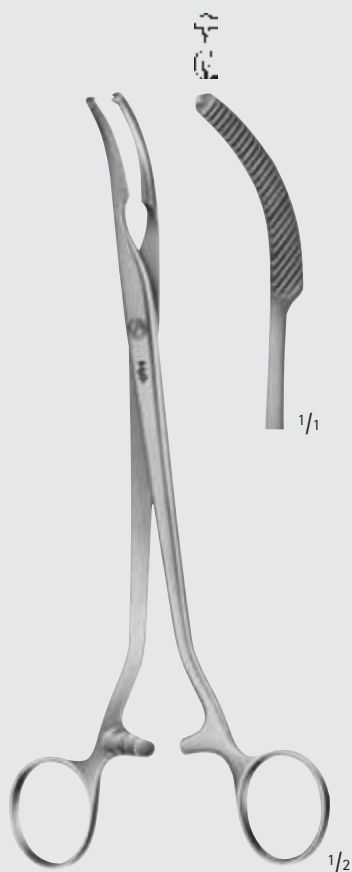

MIKULICZ

**BJ309R**

205 mm, 8"

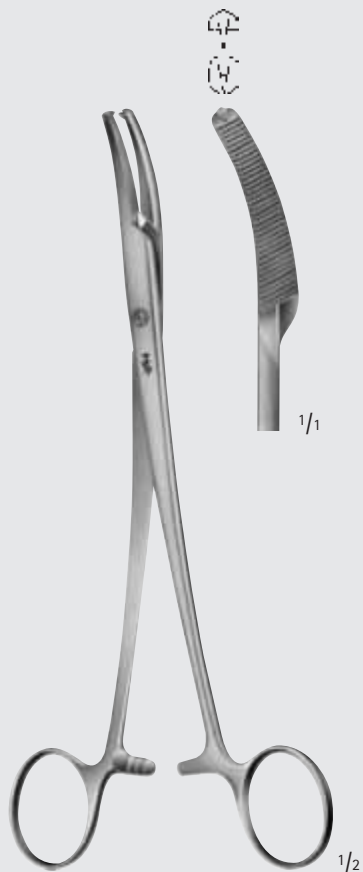

MIKULICZ

**BJ310R**

200 mm, 8"



MIKULICZ

**BJ312R**

245 mm, 9 3/4"



**Klemmen – Forceps**  
Peritoneumklemmen  
Peritoneum Forceps

**BJ**

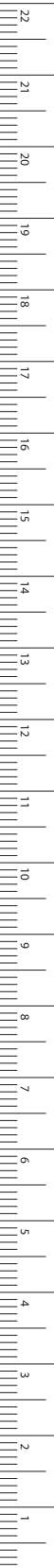

MILLIMETERS

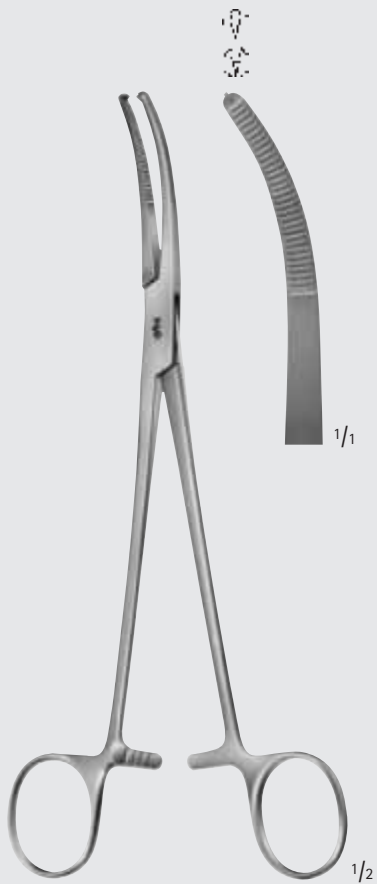

MIKULICZ

**BJ313R**

205 mm, 8"



MIKULICZ

**BJ314R**

205 mm, 8"

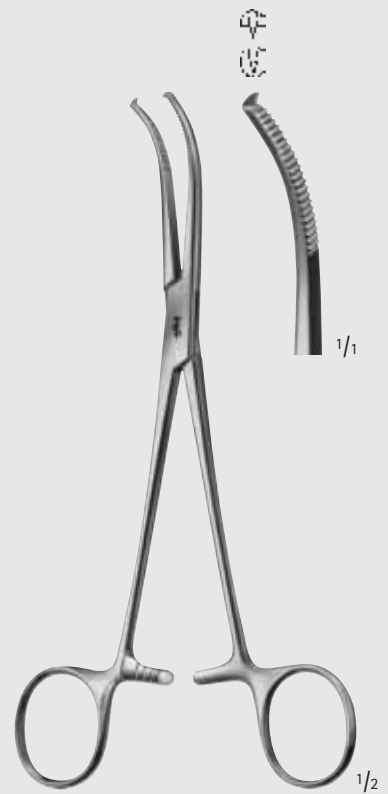

MIKULICZ

**BJ315R**

185 mm, 7 1/4"

**Klemmen – Forceps**  
 Hysterektomieklemmen  
 Hysterectomy Forceps

**BJ**

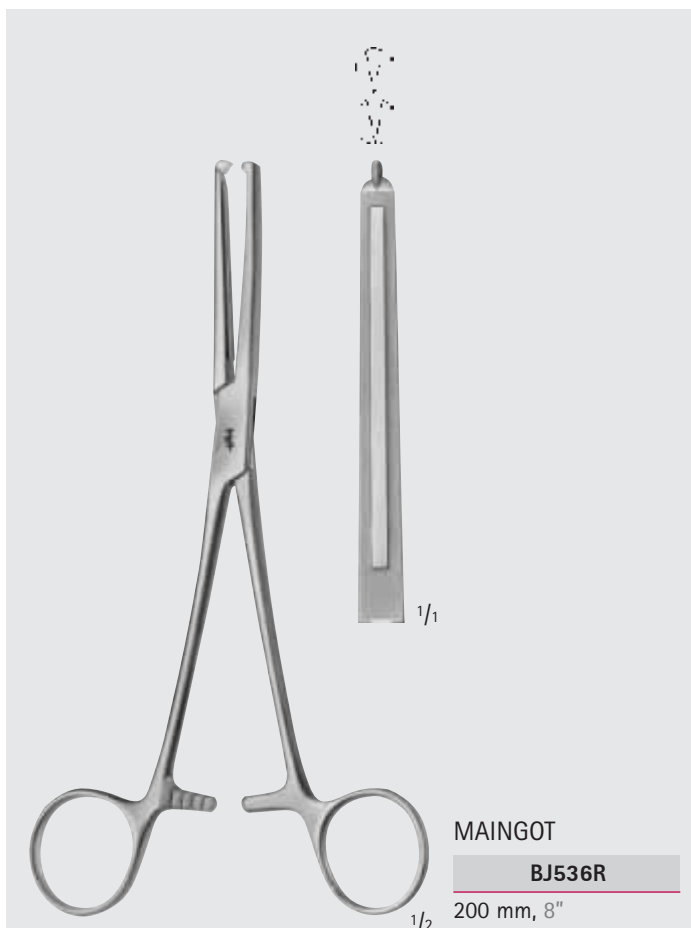
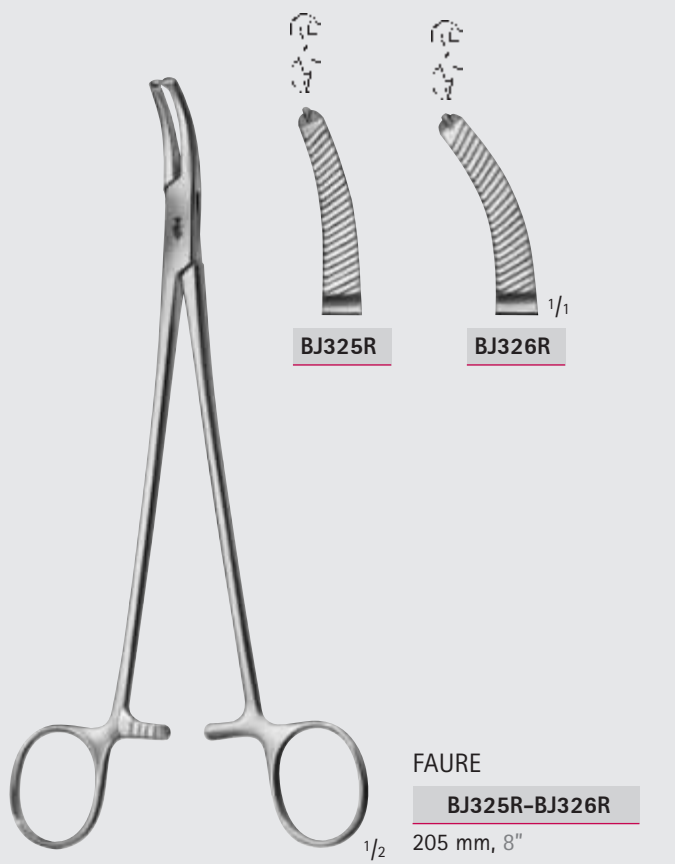





## Klemmen – Forceps

Peritoneum- und Hysterektomieklemmen  
Peritoneum and Hysterectomy Forceps

BJ



HEANEY MODIF.

**BJ520R-BJ529R**



HEANEY

**BJ522R**

195 mm, 7 3/4"



HEANEY-REZEK

**BJ524R**

210 mm, 8 1/4"

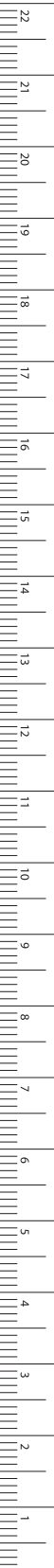

MILLIMETERS

**Klemmen – Forceps**  
 Hysterektomieklemmen  
 Hysterectomy Forceps

**BJ**



HEANEY-BALLENTINE

**MD591-MD592**

215 mm, 8 1/2"

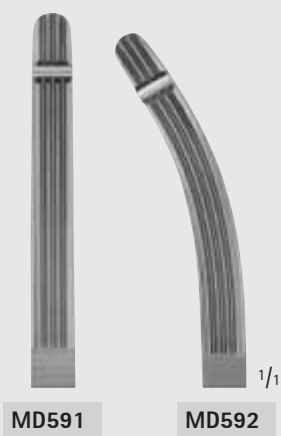

**MD591**

**MD592**

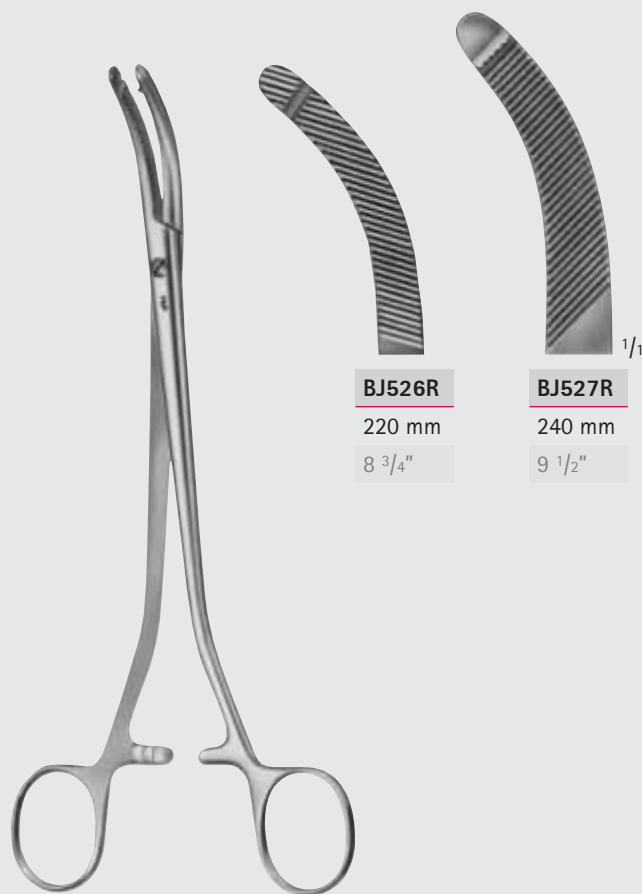

WIENER MODELL

**BJ526R-BJ527R**

**BJ526R**

220 mm

8 3/4"

**BJ527R**

240 mm

9 1/2"



**Klemmen – Forceps**  
Hysterektomie- und Arterienklemmen  
Hysterectomy- and Hemostatic Forceps

**BJ**



WERTHEIM

**BJ506R**

235 mm, 9 1/4"



WERTHEIM

**BJ507R**

235 mm, 9 1/4"

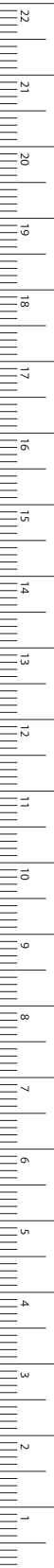

MILLIMETERS

## Klemmen – Forceps

Hysterektomie- und Arterienklemmen

Hysterectomy- and Hemostatic Forceps

BJ

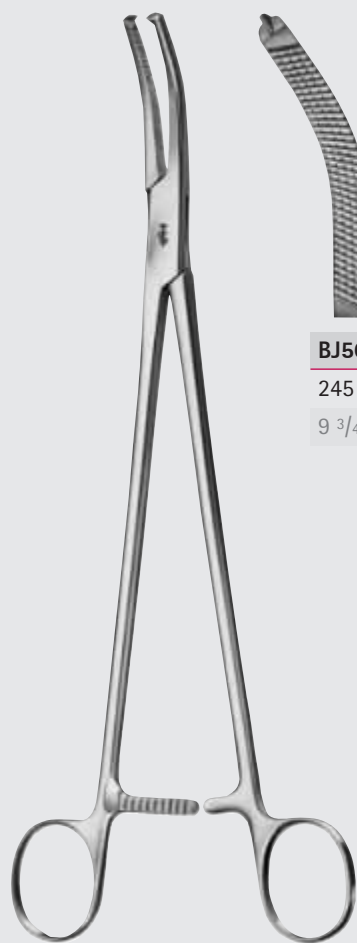

WERTHEIM

**BJ509R-BJ515R**



**BJ509R**

245 mm

9 3/4"

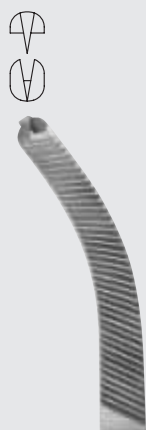

**BJ515R**

350 mm

14"



SEGOND-LANDAU

**BJ540R**

240 mm, 9 1/2"



1/1

1/2



**Klemmen – Forceps**  
 Hysterektomie- und Arterienklemmen  
 Hysterectomy- and Hemostatic Forceps

**BJ**

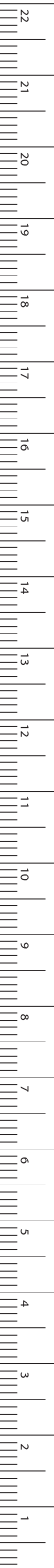

MILLIMETERS

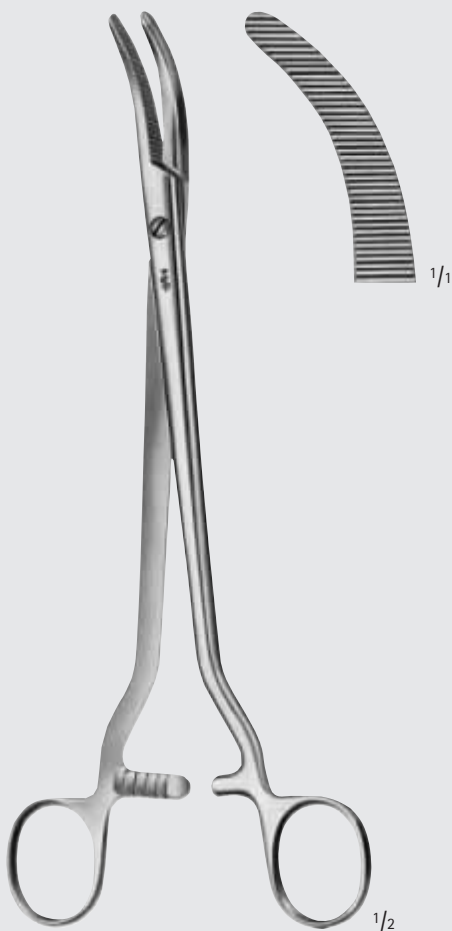

SEGOND

**BJ541R**

240 mm, 9 1/2"

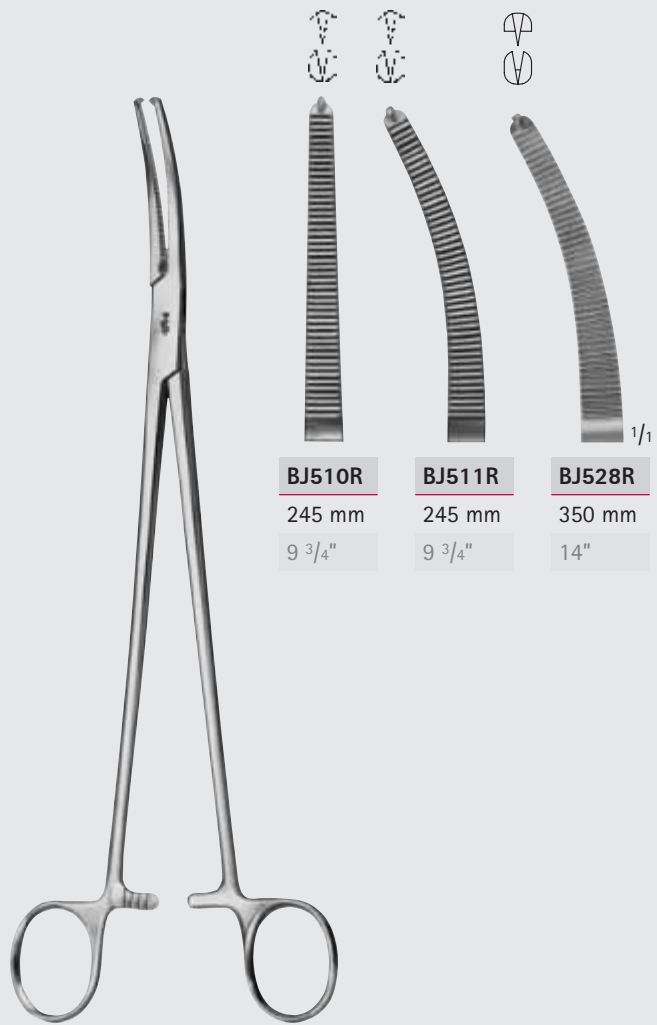

**BJ510R**

245 mm

9 3/4"

**BJ511R**

245 mm

9 3/4"

**BJ528R**

350 mm

14"

HOLZBACH

**BJ510R-BJ528R**

## Klemmen – Forceps

Hysterektomie- und Arterienklemmen

Hysterectomy- and Hemostatic Forceps

BJ

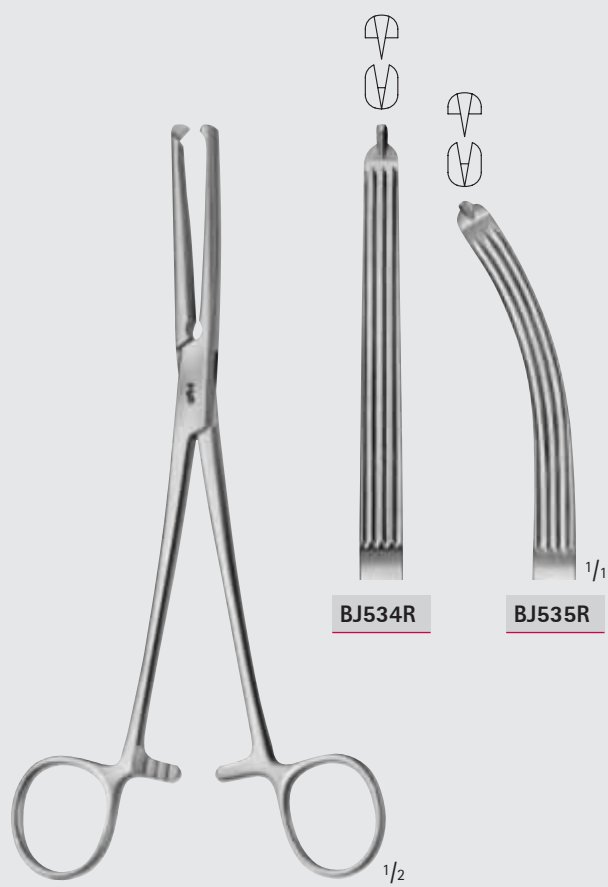

GWILLIAM

**BJ534R-BJ535R**

200 mm, 8"

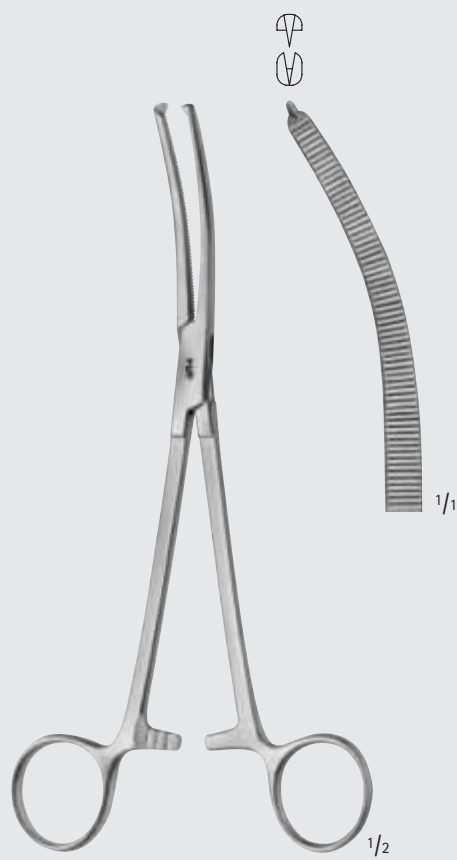

BERKELEY-BONNEY

**BJ537R**

200 mm, 8"



DE BAKEY Zahnung

Toothing DE BAKEY

**ARAUMATA**<sup>®</sup>

**Klemmen – Forceps**  
Hysterektomie- und Vaginalklemmen  
Hysterectomy Forceps and Vaginal Clamps

**BJ**

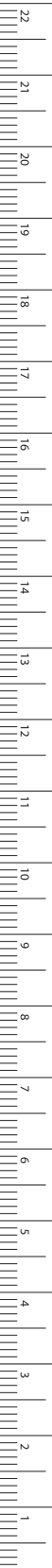

HEANEY

**BJ530R-BJ532R**



**BJ530R**

225 mm

9"



**BJ531R**

220 mm

8 <sup>3</sup>/<sub>4</sub>"



**BJ532R**

215 mm

8 <sup>1</sup>/<sub>2</sub>"

<sup>1</sup>/<sub>1</sub>

MILLIMETERS

**Klemmen – Forceps**  
Hysterektomie- und Vaginalklemmen  
Hysterectomy Forceps and Vaginal Clamps

DE BAKEY Zahnung

**ATRAUMATA®**

Toothing DE BAKEY

**BJ**



WERTHEIM

**BJ550R-BJ553R**



**BJ550R**  
250 mm  
10"



**BJ551R**  
245 mm  
9 3/4"



**BJ552R**  
240 mm  
9 1/2"

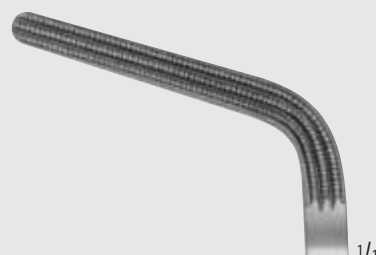

**BJ553R**  
220 mm  
8 3/4"





DE BAKEY Zahnung

Toothings DE BAKEY

**ARAUMATA**<sup>®</sup>

**Klemmen – Forceps**  
Hysterektomie- und Vaginalklemmen  
Hysterectomy Forceps and Vaginal Clamps

**BJ**

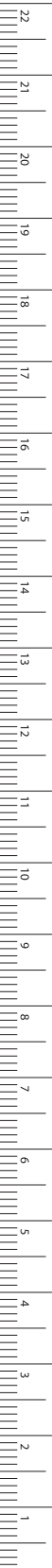

MILLIMETERS

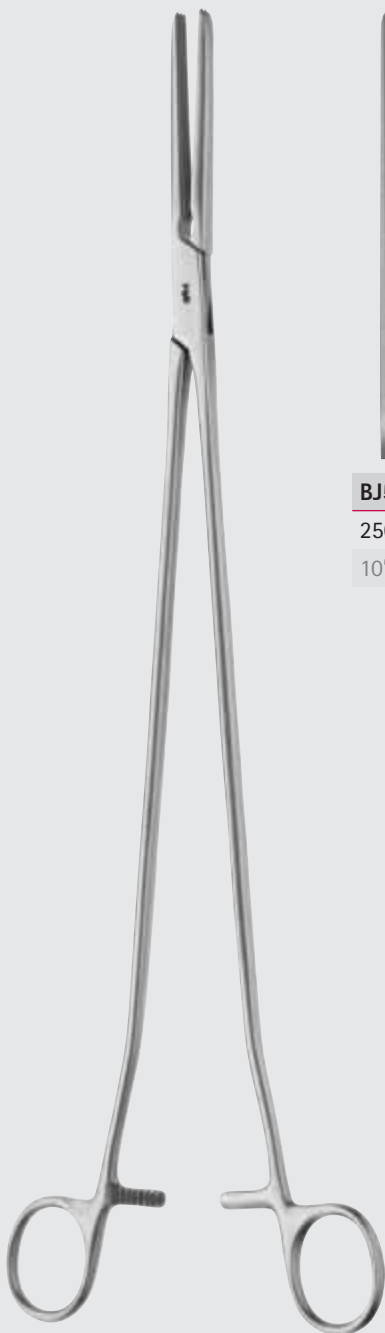

**BJ582R**

250 mm

10"



**BJ584R**

350 mm

14"



**BJ583R**

250 mm

10"



**BJ585R**

350 mm

14"

<sup>1</sup>/<sub>1</sub>

WERTHEIM

**BJ582R-BJ585R**

## Klemmen – Forceps

Hysterektomie- und Vaginalklemmen

Hysterectomy Forceps and Vaginal Clamps

BJ



WERTHEIM

**BJ574R**

255 mm, 10"



WERTHEIM

**BJ576R**

260 mm, 10 1/4"



**Klemmen – Forceps**  
 Hysterektomie- und Vaginalklemmen  
 Hysterectomy Forceps and Vaginal Clamps

**BJ**

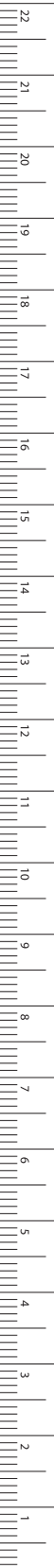

MILLIMETERS



<b>BJ560R</b>	<b>BJ562R</b>
250 mm	350 mm
10"	14"

**BURKE**  
**BJ560R-BJ562R**  
 Parametriumklemme, kurzes Maul  
 Parametrium clamp, short jaw part



<b>BJ561R</b>	<b>BJ563R</b>
250 mm	350 mm
10"	14"

**BURKE**  
**BJ561R-BJ563R**  
 Parametriumklemme, langes Maul  
 Parametrium clamp, long jaw part

# Klemmen – Forceps

Klemmzangen

Clamps and Compression Forceps

DE BAKEY Zahnung

AIRAUMATA®

Toothing DE BAKEY

BJ

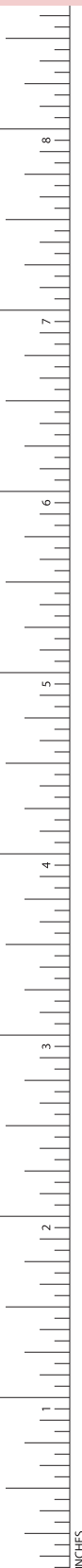

**FB956R**

255 mm

10"

**FB957R**

265 mm

10 1/2"

**FB958R**

275 mm

10 3/4"

DICK

**FB956R-FB958R**

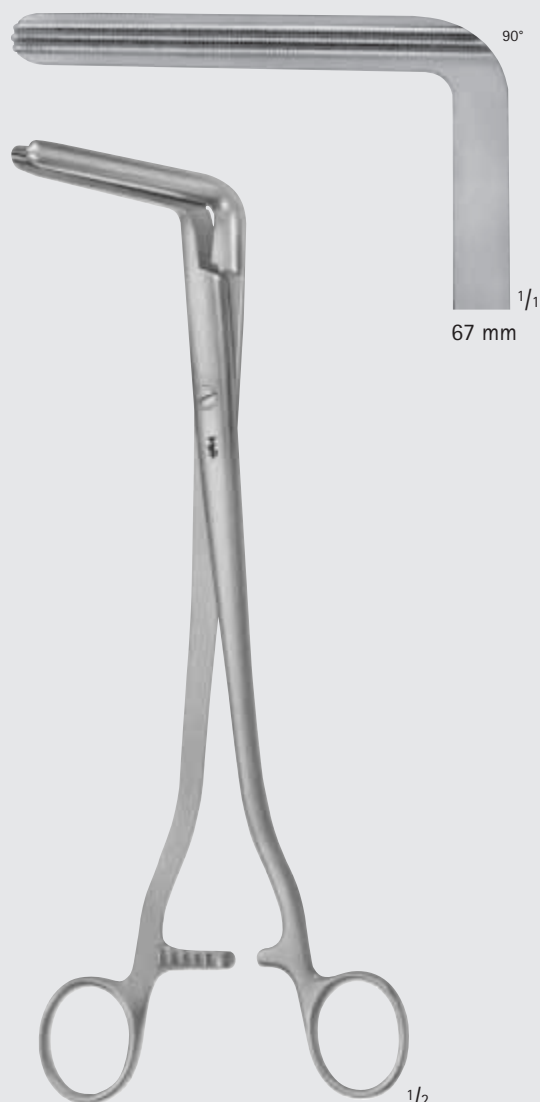

WERTHEIM

**BJ581R**

250 mm, 10"



## Klemmen – Forceps

Klemmzangen

Clamps and Compression Forceps

BJ

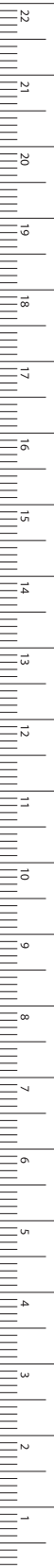

MILLIMETERS



WERTHEIM-CULLEN

**BJ579R**

215 mm, 8 1/2"



**FB954R**  
60 mm

**FB955R**  
80 mm

**FB954R-FB955R**

230 mm, 9"



INCHES



BL



**Nähnadeln, Nadeldosen**  
Surgical Needles, Needle Cases

## Nähnadeln, Nähnosen – Surgical Needles, Needle Cases

Chirurgische Nähnadeln

Surgical Needles

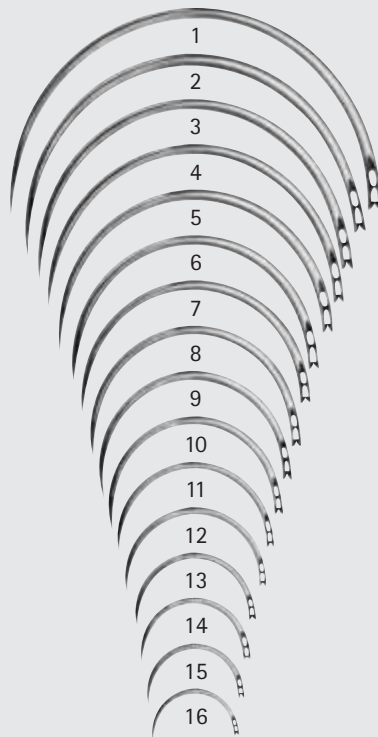
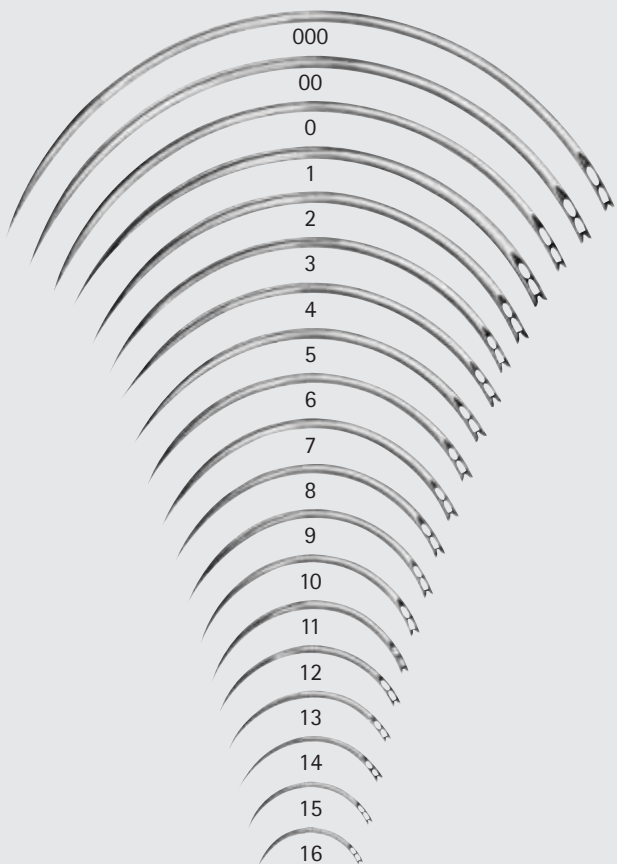





Fig.	 	Ø x Länge Diam. x length	 	Ø x Länge Diam. x length
000	<a href="#">BL058N</a>	1,60 x 102 mm	<a href="#">BL098N</a>	1,60 x 102 mm
00	<a href="#">BL059N</a>	1,60 x 94 mm	<a href="#">BL099N</a>	1,60 x 94 mm
0	<a href="#">BL060N</a>	1,60 x 85 mm	<a href="#">BL100N</a>	1,60 x 85 mm
1	<a href="#">BL061N</a>	1,40 x 80 mm	<a href="#">BL101N</a>	1,40 x 80 mm
2	<a href="#">BL062N</a>	1,40 x 73 mm	<a href="#">BL102N</a>	1,40 x 73 mm
3	<a href="#">BL063N</a>	1,30 x 68 mm	<a href="#">BL103N</a>	1,30 x 68 mm
4	<a href="#">BL064N</a>	1,30 x 63 mm	<a href="#">BL104N</a>	1,30 x 63 mm
5	<a href="#">BL065N</a>	1,20 x 58 mm	<a href="#">BL105N</a>	1,20 x 58 mm
6	<a href="#">BL066N</a>	1,10 x 54 mm	<a href="#">BL106N</a>	1,10 x 54 mm
7	<a href="#">BL067N</a>	1,10 x 50 mm	<a href="#">BL107N</a>	1,10 x 50 mm
8	<a href="#">BL068N</a>	1,00 x 46 mm	<a href="#">BL108N</a>	1,00 x 46 mm
9	<a href="#">BL069N</a>	1,00 x 42 mm	<a href="#">BL109N</a>	1,00 x 42 mm
10	<a href="#">BL070N</a>	0,90 x 38 mm	<a href="#">BL110N</a>	0,90 x 38 mm
11	<a href="#">BL071N</a>	0,80 x 34 mm	<a href="#">BL111N</a>	0,80 x 34 mm
12	<a href="#">BL072N</a>	0,70 x 30 mm	<a href="#">BL112N</a>	0,70 x 30 mm
13	<a href="#">BL073N</a>	0,70 x 27 mm	<a href="#">BL113N</a>	0,70 x 27 mm
14	<a href="#">BL074N</a>	0,70 x 23 mm	<a href="#">BL114N</a>	0,70 x 23 mm
15	<a href="#">BL075N</a>	0,60 x 20 mm	<a href="#">BL115N</a>	0,60 x 20 mm
16	<a href="#">BL076N</a>	0,60 x 18 mm	<a href="#">BL116N</a>	0,60 x 18 mm

	 	Ø x Länge Diam. x length	 	Ø x Länge Diam. x length
	<a href="#">BL161N</a>	1,40 x 80 mm	<a href="#">BL201N</a>	1,40 x 80 mm
	<a href="#">BL162N</a>	1,40 x 73 mm	<a href="#">BL202N</a>	1,40 x 73 mm
	<a href="#">BL163N</a>	1,30 x 68 mm	<a href="#">BL203N</a>	1,30 x 68 mm
	<a href="#">BL164N</a>	1,30 x 63 mm	<a href="#">BL204N</a>	1,30 x 63 mm
	<a href="#">BL165N</a>	1,20 x 58 mm	<a href="#">BL205N</a>	1,20 x 58 mm
	<a href="#">BL166N</a>	1,10 x 54 mm	<a href="#">BL206N</a>	1,10 x 54 mm
	<a href="#">BL167N</a>	1,10 x 50 mm	<a href="#">BL207N</a>	1,10 x 50 mm
	<a href="#">BL168N</a>	1,00 x 46 mm	<a href="#">BL208N</a>	1,00 x 46 mm
	<a href="#">BL169N</a>	1,00 x 42 mm	<a href="#">BL209N</a>	1,00 x 42 mm
	<a href="#">BL170N</a>	0,90 x 38 mm	<a href="#">BL210N</a>	0,90 x 38 mm
	<a href="#">BL171N</a>	0,80 x 34 mm	<a href="#">BL211N</a>	0,80 x 34 mm
	<a href="#">BL172N</a>	0,70 x 30 mm	<a href="#">BL212N</a>	0,70 x 30 mm
	<a href="#">BL173N</a>	0,70 x 27 mm	<a href="#">BL213N</a>	0,70 x 27 mm
	<a href="#">BL174N</a>	0,70 x 23 mm	<a href="#">BL214N</a>	0,70 x 23 mm
	<a href="#">BL175N</a>	0,60 x 20 mm	<a href="#">BL215N</a>	0,60 x 20 mm
	<a href="#">BL176N</a>	0,60 x 18 mm	<a href="#">BL216N</a>	0,60 x 18 mm







# Nähnadeln, Nähnosen – Surgical Needles, Needle Cases

## Chirurgische Nähnadeln

### Surgical Needles

Nähnadeln

Bestelleinheit: **PAK** = Packung à 12 Stück

Suture needles

Sales unit: Package of 12 pieces

**BL**

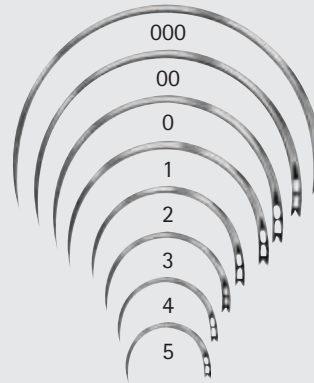
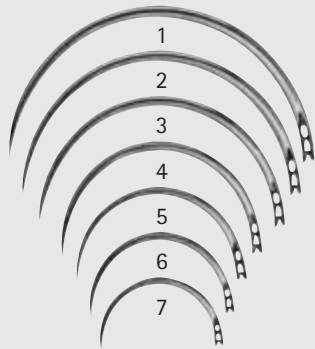

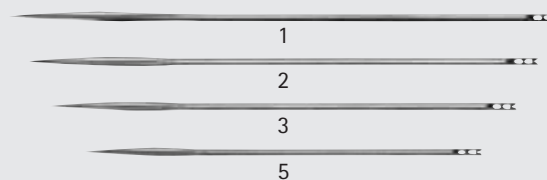

Fig.		Ø x Länge Diam. x length		Ø x Länge Diam. x length
000				
00				
0				
1	<b>BL231N</b>	1,60 x 65 mm	<b>BL251N</b>	1,60 x 65 mm
2	<b>BL232N</b>	1,60 x 60 mm	<b>BL252N</b>	1,60 x 60 mm
3	<b>BL233N</b>	1,40 x 52 mm	<b>BL253N</b>	1,40 x 52 mm
4	<b>BL234N</b>	1,40 x 45 mm	<b>BL254N</b>	1,40 x 45 mm
5	<b>BL235N</b>	1,30 x 37 mm	<b>BL255N</b>	1,30 x 37 mm
6	<b>BL236N</b>	1,10 x 32 mm	<b>BL256N</b>	1,10 x 32 mm
7	<b>BL237N</b>	1,00 x 26 mm	<b>BL257N</b>	1,00 x 26 mm

Fig.		Ø x Länge Diam. x length
<b>BL318N</b>		1,10 x 72 mm
<b>BL319N</b>		1,10 x 63 mm
<b>BL320N</b>		1,00 x 54 mm
<b>BL321N</b>		1,00 x 45 mm
<b>BL322N</b>		0,90 x 36 mm
<b>BL323N</b>		0,80 x 29 mm
<b>BL324N</b>		0,70 x 23 mm
<b>BL325N</b>		0,60 x 20 mm

Fig.		Ø x Länge Diam. x length
1	<b>BL301N</b>	0,80 x 75 mm
2	<b>BL302N</b>	0,80 x 70 mm
3	<b>BL303N</b>	0,80 x 65 mm
5	<b>BL305N</b>	0,70 x 55 mm

KEITH



MILLIMETERS

# Nähnadeln, Nähösen – Surgical Needles, Needle Cases

Chirurgische Nadeln und Nähmaterial

Surgical Needles and Suture Material

Nähnadeln

Bestelleinheit: **PAK** = Packung à 12 Stück

Suture needles

Sales unit: Package of 12 pieces

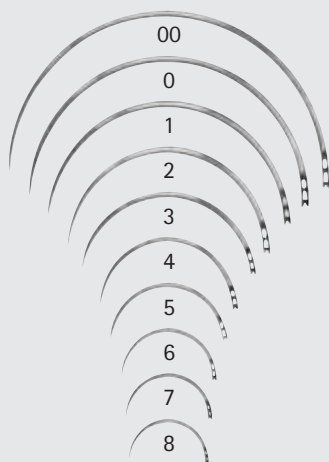

Darmnadeln

Intestinal needles

Fig.		Ø x Länge Diam. x length
00	<b>BL539N</b>	0,70 x 68 mm
0	<b>BL540N</b>	0,70 x 60 mm
1	<b>BL541N</b>	0,70 x 52 mm
2	<b>BL542N</b>	0,70 x 42 mm
3	<b>BL543N</b>	0,60 x 36 mm
4	<b>BL544N</b>	0,60 x 30 mm
5	<b>BL545N</b>	0,60 x 24 mm
6	<b>BL546N</b>	0,60 x 22 mm
7	<b>BL547N</b>	0,60 x 20 mm
8	<b>BL548N</b>	0,60 x 18 mm



Augennadeln

Eye needles

	Ø x Länge Diam. x length
<b>BL601N</b>	0,60 x 30 mm
<b>BL602N</b>	0,60 x 24 mm
<b>BL603N</b>	0,60 x 20 mm
<b>BL604N</b>	0,60 x 15 mm
<b>BL605N</b>	0,60 x 12 mm



Augennadeln

Eye needles

	Durchmesser x Länge
<b>BL611N</b>	0,60 x 30 mm
<b>BL612N</b>	0,60 x 24 mm
<b>BL613N</b>	0,60 x 19 mm
<b>BL614N</b>	0,60 x 15 mm
<b>BL615N</b>	0,60 x 12 mm

BL





## Nähadeln, Nähdosens – Surgical Needles, Needle Cases

Nadeldosen  
Needle Cases

BL



**BL907R**

70 x 53 x 9 mm



**BL941R**

150 x 90 x 10 mm



**BL910R** 50 x 25 x 5 mm

**BL911R** 50 x 30 x 6 mm

**BL915R** 75 x 25 x 5 mm



**BL943R**

205 x 120 x 12 mm



**BL930R** Nadeldose mit Innendose Needle case with interior box 65 x 16 mm

**BL932R** Nadeldose mit Innendose Needle case with interior box 95 x 16 mm

**BL929R** Außendose von BL930R allein Exterior box of BL930R only 65 x 16 mm

**BL931R** Innendose von BL930R allein Interior box of BL930R only 62 x 17 mm

**BL933R** Innendose von BL932R allein Interior box of BL932R only 90 x 17 mm



MILLIMETERS



INCHES

BM



**Nadelhalter, Naht-Instrumente,  
Unterbindungsnadeln und Hohlsonden**  
Needle Holders, Suture Instruments,  
Ligature Needles, Guiding Probes

## Nadelhalter – Needle Holders

Mikro-Nadelhalter mit Flachgriff

Micro Needle Holders with Flat Handles

BM

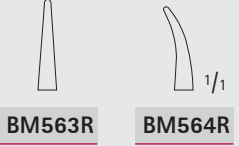

**BM563R**

**BM564R**

1/2

CASTROVIEJO

**BM563R-BM564R**

mit Sperre  
with catch

145 mm, 5 3/4"

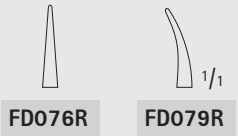

**FD076R**

**FD079R**

1/2

**FD076R-FD079R**

ohne Sperre  
without catch

160 mm, 6 1/4"

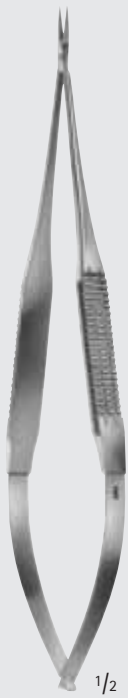

**FD080R**

**FD081R**

1/2

**FD080R-FD081R**

ohne Sperre  
without catch

185 mm, 7 1/4"



**FD045R**

**FD046R**

ohne Sperre  
without catch

mit Sperre  
with catch

1/2

JACOBSON

**FD045R-FD046R**

185 mm, 7 1/4"

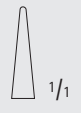

1/1

1/2

**FD048R**

mit Sperre  
with catch

200 mm, 8"





## Nadelhalter – Needle Holders

### Mikro-Nadelhalter mit Rundgriffen

### Micro Needle Holders with Round Handles

BM

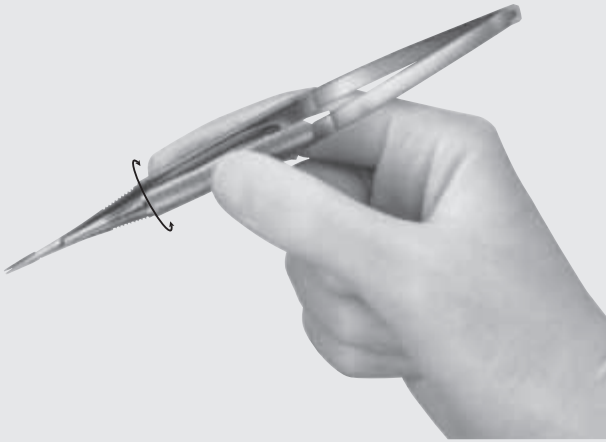

#### ... mit Rundgriffen

- Rundgriffe erlauben Drehbewegungen zwischen den Fingern.
- Optimale Balance, individuell je nach Instrument, durch volle oder gehöhlte Griffpartien.

#### ... with round handles

- Round handles allow turning manipulations between the fingers.
- Optimum balance individually for each instrument due to solid or hollowed-out handles.

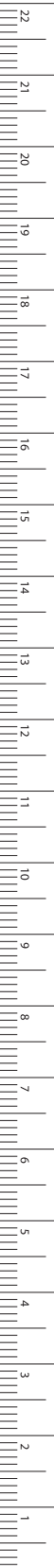

MILLIMETERS



BARRAQUER

**BM560R-BM562R**

ohne Sperre  
without catch

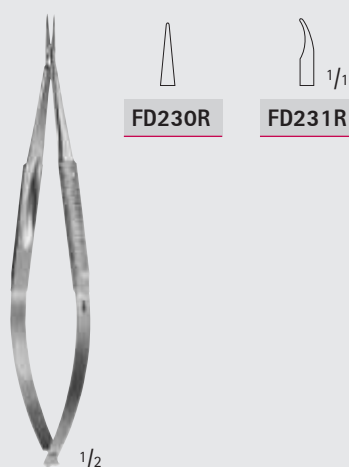

BARRAQUER

**FD230R-FD231R**

ohne Sperre  
without catch  
120 mm, 4 3/4"

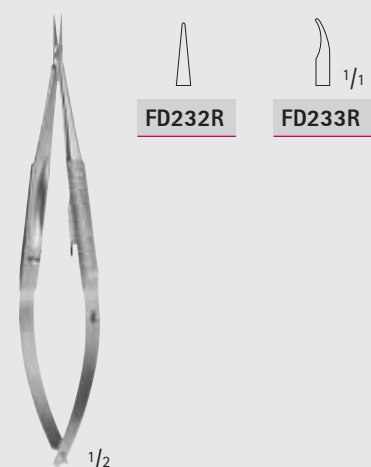

BARRAQUER

**FD232R-FD233R**

mit Sperre  
with catch  
120 mm, 4 3/4"

## Nadelhalter – Needle Holders

Mikro-Nadelhalter mit Rundgriffen

Micro Needle Holders with Round Handles

BM



FD240R

FD241R

1/2

REILL

FD240R-FD241R

ohne Sperre

without catch

150 mm, 6"



FD242R

FD243R

1/2

FD242R-FD243R

mit Sperre

with catch

150 mm, 6"



FD244R

FD245R

1/2

FD244R-FD245R

ohne Sperre

without catch

185 mm, 7 1/4"



FD246R

FD247R

1/2

FD246R-FD247R

mit Sperre

with catch

185 mm, 7 1/4"





## Nadelhalter – Needle Holders

Mikro-Nadelhalter mit leichtem Kunststoffgriffprofil  
Micro Needle Holders with Lightweight Plastic Handles



### Das MÜLLER Mikro-Instrumentarium

Ein hochwertiges Set für die periphere Mikrochirurgie. Zahlreiche praxisbewährte Details führen zu mehr Effektivität und Sicherheit.

#### ■ Unverkrampte Haltung = mehr Feingefühl

Das leichte Kunststoffprofil vergrößert die Griffoberfläche, gewährleistet dadurch eine unverkrampte Handhaltung und verleiht mehr Feingefühl.

#### ■ Leichteres Drehen = erweiterter Arbeitsbereich

Der runde Griffquerschnitt ermöglicht leichtes, gleichmäßiges Drehen des Instrumentes. Verwendungs- bzw. Arbeitsbereich wird dadurch erweitert.

#### ■ Sicherer Halt

Das griffige Noppenprofil gewährleistet einen durchweg sicheren Halt bei sämtlichen Bewegungsabläufen.

#### ■ Optimales Handling

Eine Entwicklung nach ergonomischen Gesichtspunkten, verbunden mit dem geringen Gewicht der neuen Kunststoffgriffe schaffen die Voraussetzung zu ermüdungsfreiem Arbeiten und optimalem Handling.

### The MÜLLER Micro instrument system

A top quality set for peripheral microsurgery. Numerous details tried and tested in practice mean increased efficiency and safety.

#### ■ Natural holding position = increased sensitivity

The light plastic profile increases the grip surface, thus guaranteeing a natural hand position without cramping and providing enhanced sensitivity.

#### ■ Easier rotation = extended working area

The round grip cross section permits easy and uniform rotation of the instrument. This extends the application and working areas.

#### ■ Safe grip

The easy grip studded profile guarantees a secure hold for all movements.

#### ■ Optimum handling

Development in accordance with ergonomic criteria and the low weight of the new plastic grips provide fatiguefree working and optimum handling.



MÜLLER

**FM021R**

145 mm, 5 3/4"



MÜLLER

**FM061R**

180 mm, 7"

## Nadelhalter – Needle Holders

### DUROGRIP® Mikro-Nadelhalter

### DUROGRIP® Micro Needle Holders



BM

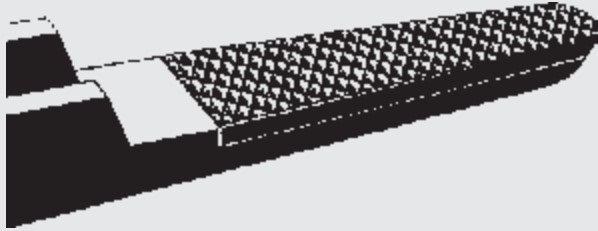

glatt  
smooth



0,2



0,4



0,5

AESCULAP-Nadelhalter sind durch die Struktur der Hartmetall-Maulteile auf das jeweilige, indikationsbezogene Nahtmaterial abgestimmt. Eine glatte Maulfläche sowie 3 verschiedene Haftprofile garantieren den sicheren „Griff“ der jeweiligen Nadel.

AESCULAP needle holders have jaws with carbide inserts and according to the use required the resp. structure can be chosen. A smooth jaw surface as well as 3 different serrations guarantee a sure „grip“ of the resp. needle.

Wir empfehlen Hartmetall-Maulteile mit glatter Fläche für Nahtmaterial mit Teilung 0,2 mm für Nahtmaterial 0,4 mm 0,5 mm

9/0 – 11/0  
6/0 – 10/0  
4/0 – 6/0  
bis 3/0

We recommend carbide inserts with smooth jaw surface for suture material with 0.2 mm pitch of serration for suture material 0.4 mm 0.5 mm

9/0 – 11/0  
6/0 – 10/0  
4/0 – 6/0  
up to 3/0



**DUROGRIP®-Nadelhalter mit Hartmetall-Plättchen**  
**Kennzeichnung:**  
**Vergoldete Ringe, Branchenenden und Sperren**  
DUROGRIP® Needle Holders with carbide inserts  
Identification:  
gold-plated rings, handle ends and ratchets



1/1  
mit glattem Maul  
with smooth jaw

1/2

CASTROVIEJO

**BM001R**

145 mm, 5 3/4"



1/1  
0,2

1/2

CASTROVIEJO

**BM002R**

145 mm, 5 3/4"



1/1  
0,4

1/2

**BM003R**

170 mm, 6 3/4"



## Nadelhalter – Needle Holders

### DUROGRIP Mikro-Nadelhalter

### DUROGRIP Micro Needle Holders

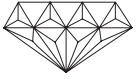

**BM**

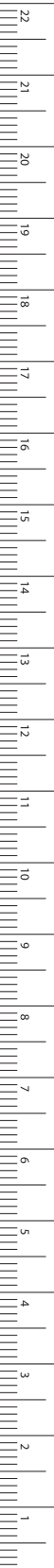

MILLIMETERS



CASTROVIEJO

**BM004R**

180 mm, 7"



CASTROVIEJO

**BM005R**

215 mm, 8 1/2"



**FM388R**

mit Sperre  
with catch  
180 mm, 7"



**FM390R**

mit Sperre  
with catch  
200 mm, 8"

DIADUST



## Nadelhalter – Needle Holders

DIADUST Mikro-Nadelhalter mit Rundgriff

DIADUST Micro Needle Holders with Round Handle

DIADUST



Die Diamantstaubbeschichtung sorgt für eine noch härtere und verschleißfestere Maulinnenfläche. Darüber hinaus garantiert die Struktur der DIADUST-Beschichtung ein zuverlässiges Fassen von feinen Nadeln und Nahtmaterialien sowie von Weichgewebe.

The diamond dust coating ensures an even harder and more wear resistant surface on the inside of the jaws. Moreover, the structure of the DIADUST coating guarantees a reliable grip for fine needles and sutures, as well as for tissue.

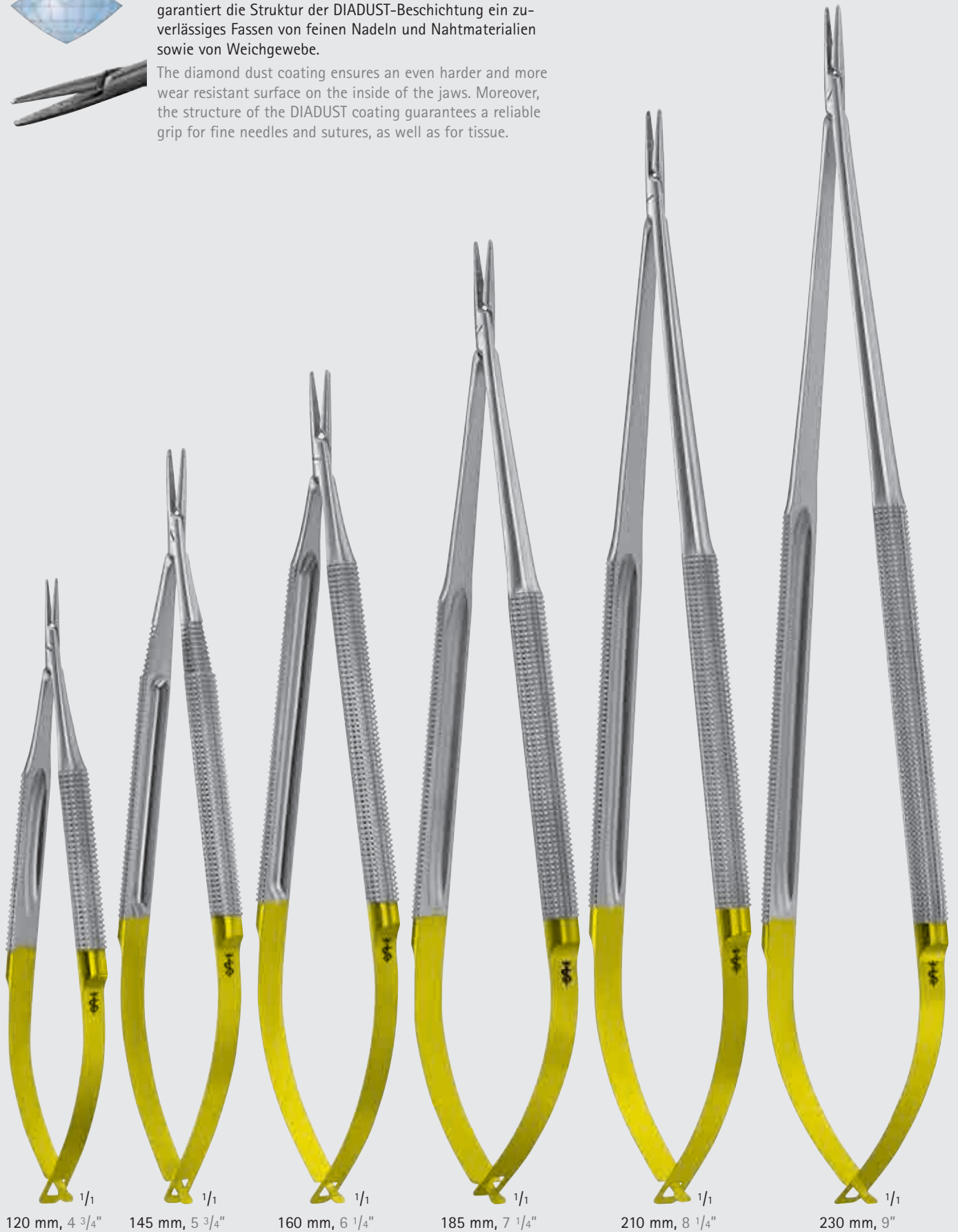

120 mm, 4 3/4" 1/1

145 mm, 5 3/4" 1/1

160 mm, 6 1/4" 1/1

185 mm, 7 1/4" 1/1

210 mm, 8 1/4" 1/1

230 mm, 9" 1/1

INCHES



DIADUST



## Nadelhalter – Needle Holders

DIADUST Mikro-Nadelhalter mit Rundgriff  
DIADUST Micro Needle Holders with Round Handle

BM

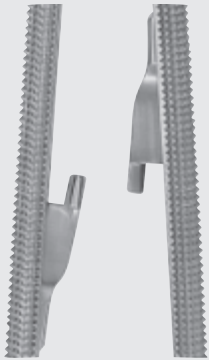

mit Sperre  
with ratchet



Nahtmaterialgröße  
Suture size

Länge (mm) Length (in.)	7/0 und kleiner 7/0 and smaller	5/0 und kleiner 5/0 and smaller	4/0 und kleiner 4/0 and smaller	4/0 und kleiner 4/0 and smaller
120 mm 4 3/4"	<b>FM520R</b>			
145 mm 5 3/4"		<b>FM522R</b>		
160 mm 6 1/4"	<b>FM521R</b>	<b>FM523R</b>		
185 mm 7 1/4"	<b>FM563R</b>	<b>FM564R</b>	<b>FM218R</b>	
210 mm 8 1/4"	<b>FM565R</b>	<b>FM566R</b>	<b>FM228R</b>	<b>FM221R</b>
230 mm 9"	<b>FM567R</b>	<b>FM568R</b>	<b>FM230R</b>	<b>FM223R</b>

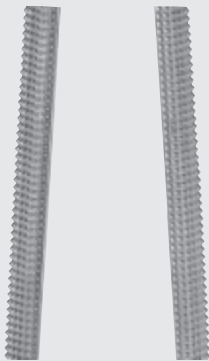

ohne Sperre  
without  
ratchet



Nahtmaterialgröße  
Suture size

Länge (mm) Length (in.)	7/0 und kleiner 7/0 and smaller	5/0 und kleiner 5/0 and smaller
120 mm 4 3/4"	<b>FM524R</b>	
145 mm 5 3/4"		<b>FM528R</b>
160 mm 6 1/4"	<b>FM525R</b>	<b>FM529R</b>
185 mm 7 1/4"	<b>FM526R</b>	<b>FM530R</b>
210 mm 8 1/4"	<b>FM527R</b>	<b>FM531R</b>
230 mm 9"	<b>FM532R</b>	<b>FM533R</b>

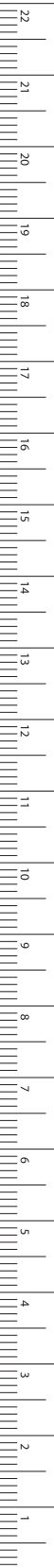

MM/MILLIMETERS

## Nadelhalter – Needle Holders

DIADUST Mikro-Nadelhalter mit Rundgriff

DIADUST Micro Needle Holders with Round Handle

DIADUST



Die Diamantstaubbeschichtung sorgt für eine noch härtere und verschleißfestere Maulinnenfläche. Darüber hinaus garantiert die Struktur der DIADUST-Beschichtung ein zuverlässiges Fassen von feinen Nadeln und Nahtmaterialien sowie von Weichgewebe.

The diamond dust coating ensures an even harder and more wear resistant surface on the inside of the jaws. Moreover, the structure of the DIADUST coating guarantees a reliable grip for fine needles and sutures, as well as for tissue.



190 mm, 7 1/2"

230 mm, 9"

250 mm, 10"

BM





DIADUST



## Nadelhalter – Needle Holders DIADUST Mikro-Nadelhalter mit Rundgriff DIADUST Micro Needle Holders with Round Handle

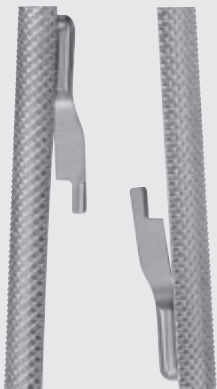

mit Sperre,  
kräftige  
Ausführung  
with ratchet,  
heavy style



Nahtmaterialgröße  
Suture size

Länge (mm)  
Length (in.)

190 mm  
7 1/2"

**FM538R**

230 mm  
9"

**FM539R**

250 mm  
10"

**FM534R**

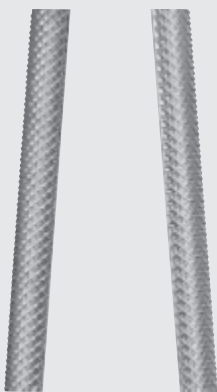

ohne Sperre,  
kräftige  
Ausführung  
without  
ratchet,  
heavy style



Nahtmaterialgröße  
Suture size

Länge (mm)  
Length (in.)

190 mm  
7 1/2"

**FM535R**

230 mm  
9"

**FM536R**

250 mm  
10"

**FM537R**

BM

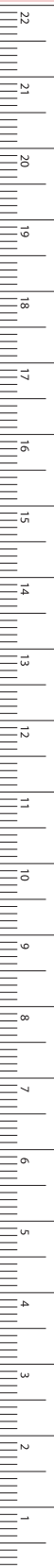

MILLIMETERS



## Nadelhalter – Needle Holders

DIADUST Mikro-Nadelhalter mit Flachgriff

DIADUST Micro Needle Holders with Flat Handles

DIADUST



Die Diamantstaubbeschichtung sorgt für eine noch härtere und verschleißfestere Maulinnenfläche. Darüber hinaus garantiert die Struktur der DIADUST-Beschichtung ein zuverlässiges Fassen von feinen Nadeln und Nahtmaterialien sowie von Weichgewebe.

The diamond dust coating ensures an even harder and more wear resistant surface on the inside of the jaws. Moreover, the structure of the DIADUST coating guarantees a reliable grip for fine needles and sutures, as well as for tissue.



145 mm, 5  $\frac{3}{4}$ "

170 mm, 6  $\frac{3}{4}$ "

185 mm, 7  $\frac{1}{4}$ "

210 mm, 8  $\frac{1}{4}$ "

230 mm, 9"

BM







DIADUST



## Nadelhalter – Needle Holders

DIADUST Mikro-Nadelhalter mit Flachgriff  
DIADUST Micro Needle Holders with Flat Handles

BM

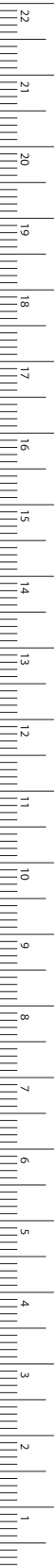

MILLIMETERS

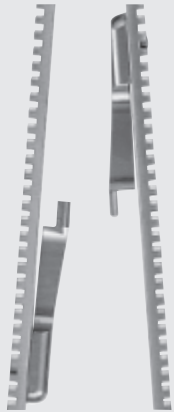

mit Sperre  
with ratchet



Nahtmaterialgröße  
Suture size

Länge (mm) Length (in.)	7/0 und kleiner 7/0 and smaller	5/0 und kleiner 5/0 and smaller
145 mm 5 3/4"		<b>FM541R</b>
170 mm 6 3/4"	<b>FM540R</b>	
185 mm 7 1/4"		<b>FM542R</b>
210 mm 8 1/4"		<b>FM543R</b>
230 mm 9"		<b>FM544R</b>

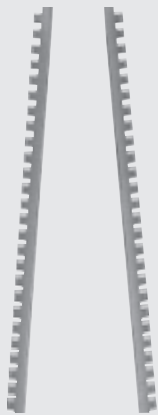

ohne Sperre  
without  
ratchet



Nahtmaterialgröße  
Suture size

Länge (mm) Length (in.)	7/0 und kleiner 7/0 and smaller	5/0 und kleiner 5/0 and smaller
145 mm 5 3/4"		<b>FM546R</b>
170 mm 6 3/4"	<b>FM545R</b>	
185 mm 7 1/4"		<b>FM547R</b>
210 mm 8 1/4"		<b>FM548R</b>
230 mm 9"		<b>FM549R</b>

DIADUST

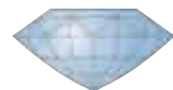

## Nadelhalter – Needle Holders

DIADUST Mikro-Nadelhalter mit Flachgriff

DIADUST Micro Needle Holder with Flat Knurled Handle

DIADUST



Die Diamantstaubbeschichtung sorgt für eine noch härtere und verschleißfestere Maulinnenfläche. Darüber hinaus garantiert die Struktur der DIADUST-Beschichtung ein zuverlässiges Fassen von feinen Nadeln und Nahtmaterialien sowie von Weichgewebe.

The diamond dust coating ensures an even harder and more wear resistant surface on the inside of the jaws. Moreover, the structure of the DIADUST coating guarantees a reliable grip for fine needles and sutures, as well as for tissue.



185 mm, 7 1/4"

210 mm, 8 1/4"

230 mm, 9"

BM





DIADUST



## Nadelhalter – Needle Holders

DIADUST Mikro-Nadelhalter mit Flachgriff  
DIADUST Micro Needle Holders with Flat Knurled Handle

BM



mit Sperre  
with ratchet



Nahtmaterialgröße  
Suture size

Länge (mm) Length (in.)	5/0 und kleiner 5/0 and smaller
185 mm 7 1/4"	<b>FM550R</b>
210 mm 8 1/4"	<b>FM551R</b>
230 mm 9"	<b>FM552R</b>



ohne Sperre  
without  
ratchet



Nahtmaterialgröße  
Suture size

Länge (mm) Length (in.)	5/0 und kleiner 5/0 and smaller
185 mm 7 1/4"	<b>FM553R</b>
210 mm 8 1/4"	<b>FM554R</b>
230 mm 9"	<b>FM555R</b>

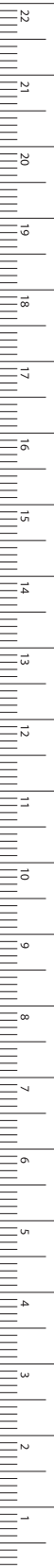

MILLIMETERS

DIADUST



## Nadelhalter – Needle Holders

DIADUST Mikro-Nadelhalter

DIADUST Micro Needle Holders

DIADUST



Die Diamantstaubbeschichtung sorgt für eine noch härtere und verschleißfestere Maulinnenfläche. Darüber hinaus garantiert die Struktur der DIADUST-Beschichtung ein zuverlässiges Fassen von feinen Nadeln und Nahtmaterialien sowie von Weichgewebe.

The diamond dust coating ensures an even harder and more wear resistant surface on the inside of the jaws. Moreover, the structure of the DIADUST coating guarantees a reliable grip for fine needles and sutures, as well as for tissue.



GLASSER

**FM560R**

Nahtmaterialgröße: 5/0 und kleiner  
Suture size: 5/0 and smaller  
125 mm, 5"



GLASSER

**FM561R**

Nahtmaterialgröße: 5/0 und kleiner  
Suture size: 5/0 and smaller  
180 mm, 7"

BM





DIADUST



# Nadelhalter – Needle Holders

DIADUST Mikro-Nadelhalter  
DIADUST Micro Needle Holders

BM

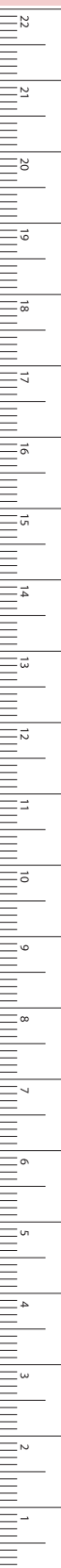

MILLIMETERS



1/2

**FD258R-FD259R**

180 mm, 7"



1/2

**FM236R**

mit Sperre  
Nahtmaterialgröße: 5/0 und kleiner  
with ratchet  
Suture size: 5/0 and smaller  
210 mm, 8 1/4"



1/2

**FM276R**

ohne Sperre  
Nahtmaterialgröße: 5/0 und kleiner  
without ratchet  
Suture size: 5/0 and smaller  
210 mm, 8 1/4"

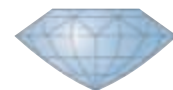

## Nadelhalter – Needle Holders

DIADUST Mikro-Nadelhalter

DIADUST Micro Needle Holders

DIADUST



Die Diamantstaubbeschichtung sorgt für eine noch härtere und verschleißfestere Maulinnenfläche. Darüber hinaus garantiert die Struktur der DIADUST-Beschichtung ein zuverlässiges Fassen von feinen Nadeln und Nahtmaterialien sowie von Weichgewebe.

The diamond dust coating ensures an even harder and more wear resistant surface on the inside of the jaws. Moreover, the structure of the DIADUST coating guarantees a reliable grip for fine needles and sutures, as well as for tissue.



BM301R	BM325R	BM302R	BM327R	BM328R
140 mm	160 mm	180 mm	220 mm	250 mm
5 1/2"	6 1/4"	7"	8 3/4"	10"



RYDER

**BM301R-BM328R**

Nahtmaterialgröße: 5/0 und kleiner

Suture Size: 5/0 and smaller



**Nadelhalter – Needle Holders**  
Nadelhalter  
Needle Holders

**BM**

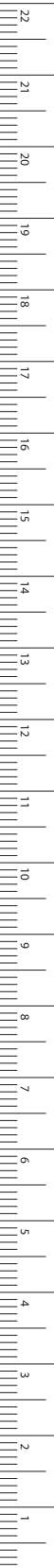

CONVERSE

**BM200R**

130 mm, 5 1/8"



WEBSTER

**BM202R**

125 mm, 5"

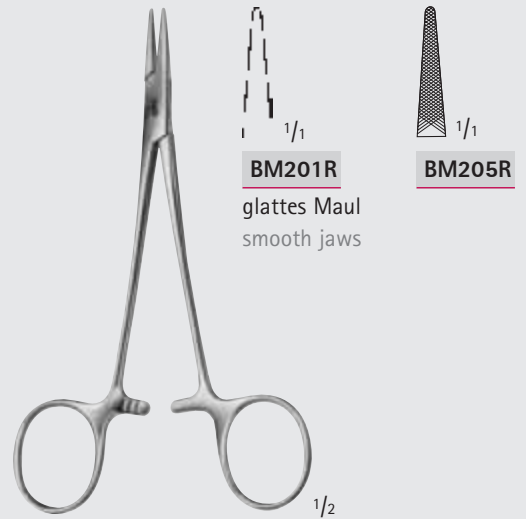

HALSEY

**BM201R-BM205R**

130 mm, 5 1/8"



DERF

**BM204R**

125 mm, 5"

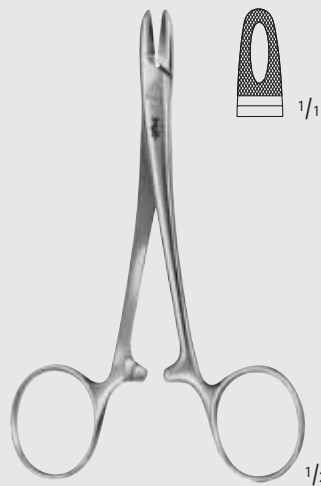

DOYEN

**BM210R**

125 mm, 5"



BAUMGARTNER

**BM215R**

145 mm, 5 3/4"

MILLIMETERS

## Nadelhalter – Needle Holders

Nadelhalter  
Needle Holders

BM



CRILE-WOOD

**BM218R**

150 mm, 6"

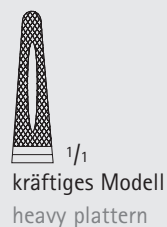
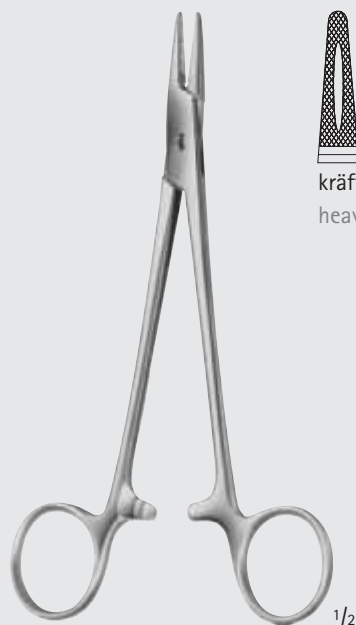

CRILE-WOOD

**BM220R**

160 mm, 6  $\frac{1}{4}$ "

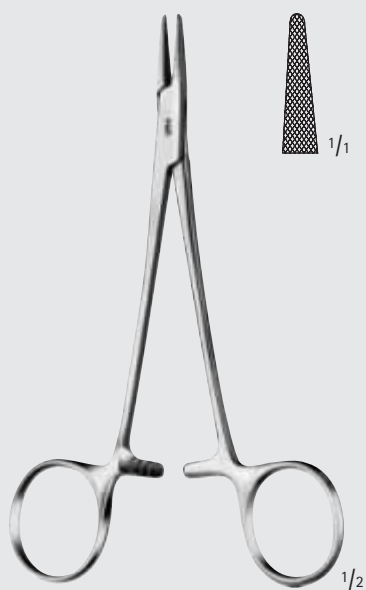

CRILE-MURRAY

**BM219R**

150 mm, 6"



KILNER

**BM211R**

135 mm, 6"





## Nadelhalter – Needle Holders

### Nadelhalter Needle Holders

**BM**



1/1  
feines Maul  
delicate jaw

LAWRANCE

**BM221R**

150 mm, 6"



1/1  
für Frontal-, Gaumennaht  
etc. geeignet  
designed for frontal and  
palate suture

ADSON

**BM224R**

180 mm, 7"

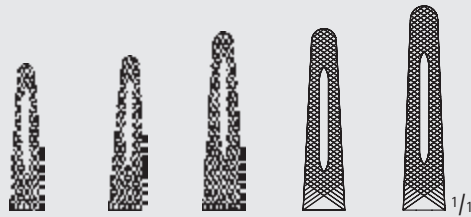

BM235R	BM236R	BM237R	BM238R	BM240R
150 mm	185 mm	200 mm	235 mm	265 mm
6"	7 1/4"	8"	9 1/4"	10 1/2"

MAYO-HEGAR

**BM235R-BM240R**

mittelfeine Modelle  
medium fine patterns

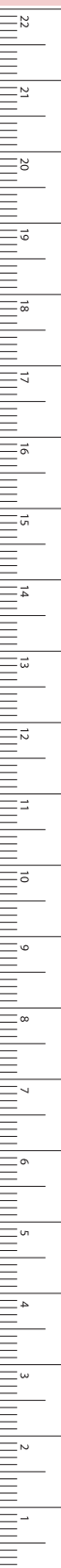

MILLIMETERS

## Nadelhalter – Needle Holders

Nadelhalter  
Needle Holders

BM

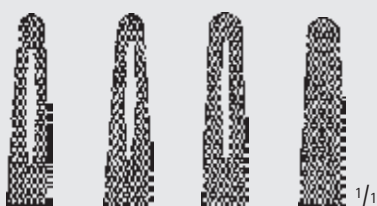

BM245R	BM247R	BM249R	BM255R
150 mm	175 mm	205 mm	205 mm
6"	7"	8"	8"

HEGAR

**BM245R-BM255R**

kräftige Modelle  
heavy patterns



BM241R	BM242R
165 mm	190 mm
6 1/2"	7 1/2"

MAYO-HEGAR

**BM241R-BM242R**



HEANEY

**BM259R**

200 mm, 8"



JAMESON

**BM270R**

230 mm, 9"



**Nadelhalter – Needle Holders**  
Nadelhalter  
Needle Holders

**BM**



WANGENSTEEN

**BM272R**

275 mm, 10 <sup>3</sup>/<sub>4</sub>"



MASSON

**BM275R**

265 mm, 10 <sup>1</sup>/<sub>2</sub>"

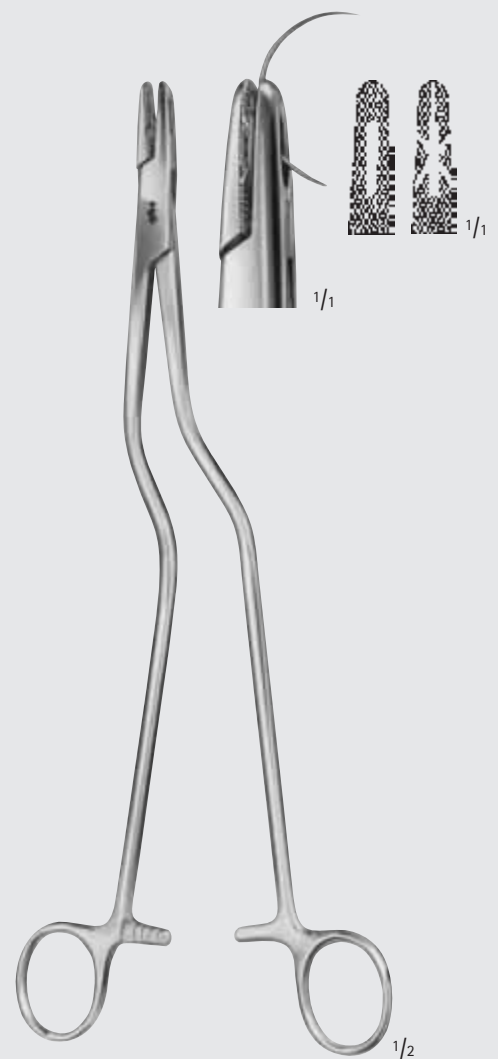

MASSON-LUETHY

**BM280R**

255 mm, 10"



MILLIMETERS

## Nadelhalter – Needle Holders

Nadelhalter mit Schere

Needle Holders with Scissors

BM



BM290R	BM291R
140 mm	185 mm
5 1/2"	7 1/4"

HEGAR-OLSEN

**BM290R-BM291R**

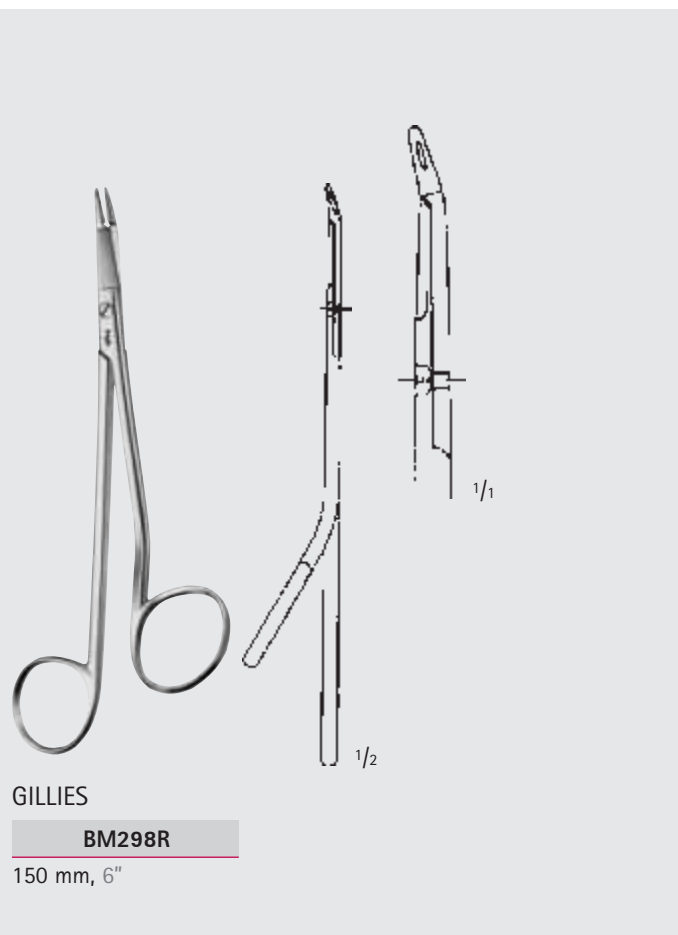

GILLIES

**BM298R**

150 mm, 6"



GILLIES

**BM299R**

160 mm, 6 1/4"



## Nadelhalter – Needle Holders

### Nadelhalter Needle Holders

**BM**

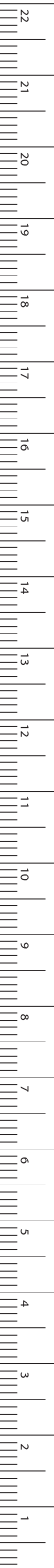

MILLIMETERS



CRILE

**BM503R**

150 mm, 6"



TÖNNIS

**BM510R**

elastisches Modell für Dura- oder Darmnaht  
elastic pattern for dura- or intestinal suture  
180 mm, 7"



BM360R	BM361R	BM362R
140 mm	170 mm	200 mm
5 1/2"	6 3/4"	8"

MATHIEU

**BM360R-BM362R**



BM406R	BM407R
175 mm	200 mm
7"	8"

MATHIEU-STILLE

**BM406R-BM407R**

sehr kräftige Modelle  
very heavy patterns

## Nadelhalter – Needle Holders

DUROGRIP® Nadelhalter

DUROGRIP® Needle Holders

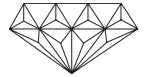

BM

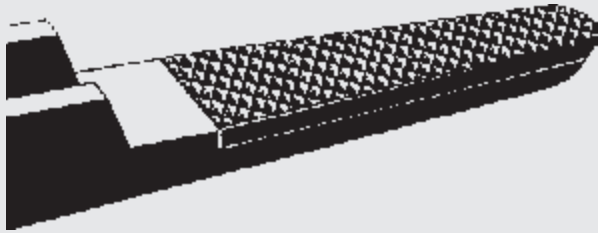

glatt  
smooth



0,2



0,4



0,5

AESULAP-Nadelhalter sind durch die Struktur der Hartmetall-Maulteile auf das jeweilige, indikationsbezogene Nahtmaterial abgestimmt. Eine glatte Maulfläche sowie 3 verschiedene Haftprofile garantieren den sicheren „Griff“ der jeweiligen Nadel.

AESULAP needle holders have jaws with carbide inserts and according to the use required the resp. structure can be chosen. A smooth jaw surface as well as 3 different serrations guarantee a sure „grip“ of the resp. needle.

Wir empfehlen Hartmetall-Maulteile mit glatter Fläche für Nahtmaterial mit Teilung 0,2 mm für Nahtmaterial 0,4 mm 0,5 mm

9/0 – 11/0  
6/0 – 10/0  
4/0 – 6/0  
bis 3/0

We recommend carbide inserts with smooth jaw surface for suture material with 0.2 mm pitch of serration for suture material 0.4 mm 0.5 mm

9/0 – 11/0  
6/0 – 10/0  
4/0 – 6/0  
up to 3/0



### DUROGRIP®-Nadelhalter mit Hartmetall-Plättchen

**Kennzeichnung:**

**Vergoldete Ringe, Branchenenden und Sperren**

DUROGRIP® Needle Holders with carbide inserts

**Identification:**

gold-plated rings, handle ends and ratchets



**Nadelhalter – Needle Holders**  
**DUROGRIP® Nadelhalter**  
**DUROGRIP® Needle Holders**

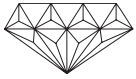

**BM**

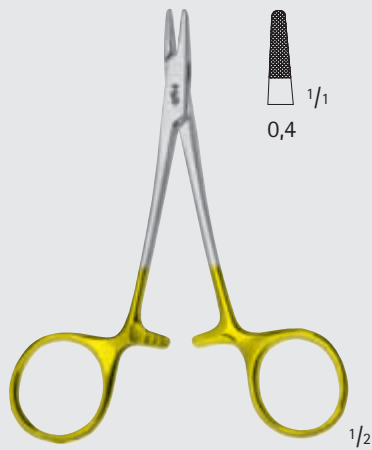
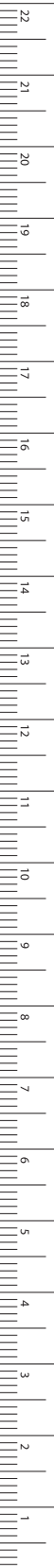

DERF

**BM008R**

115 mm, 4 1/2"



HALSEY

**BM010R**

120 mm, 4 3/4"

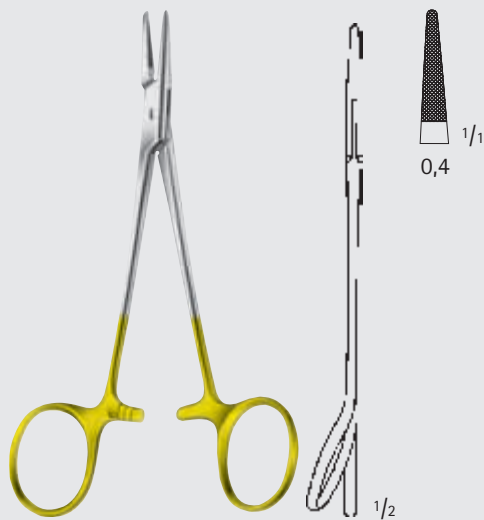

MASING

**BM009R**

ein Ring abgewinkelt  
 one ring angled  
 130 mm, 5 1/8"

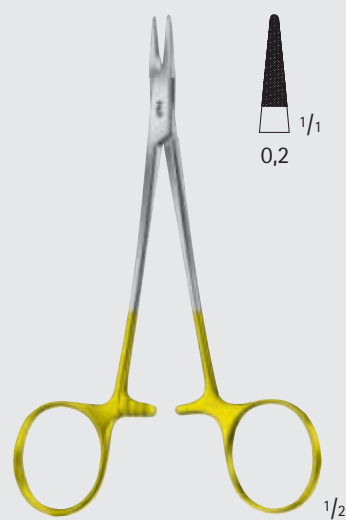

CONVERSE

**BM011R**

130 mm, 5 1/8"

MILLIMETERS

# Nadelhalter – Needle Holders

DUROGRIP® Nadelhalter

DUROGRIP® Needle Holders

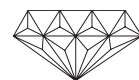

BM

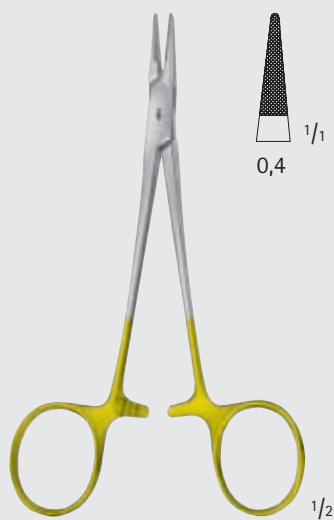

HALSEY

**BM012R**

130 mm, 5 1/8"



WEBSTER

**BM014R-BM024R**

125 mm, 5"



KILNER

**BM018R**

135 mm, 5 1/4"



BAUMGARTNER

**BM015R**

145 mm, 5 3/4"





**Nadelhalter – Needle Holders**  
**DUROGRIP® Nadelhalter**  
**DUROGRIP® Needle Holders**

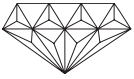

**BM**

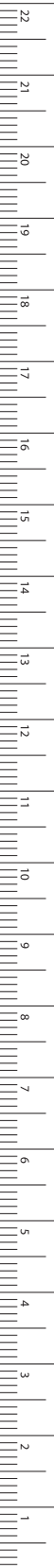

**BABY-CRILE-WOOD**  
**BM013R**  
 150 mm, 6"

BM016R	BM017R	BM019R	BM030R	BM021R
145 mm	185 mm	200 mm	270 mm	305 mm
5 3/4"	7 1/4"	8"	10 3/8"	12 1/2"

**CRILE-WOOD**  
**BM016R-BM030R**

BM020R	BM023R
175 mm	260 mm
7"	10 1/4"

**SAROT**  
**BM020R-BM023R**

**HEGAR-MAYO-SEELEY**  
**BM022R**  
 200 mm, 8"

## Nadelhalter – Needle Holders

DUROGRIP® Nadelhalter

DUROGRIP® Needle Holders

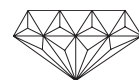

BM

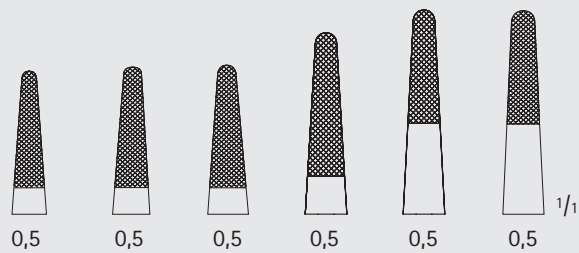

BM065R	BM066R	BM067R	BM068R	BM070R	BM069R
150 mm	185 mm	205 mm	235 mm	265 mm	300 mm
6"	7 1/4"	8"	9 1/4"	10 1/2"	12"

HEGAR-MAYO

**BM065R-BM070R**

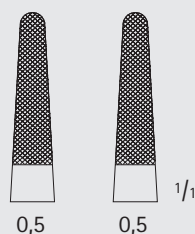

BM077R	BM078R
205 mm	245 mm
8"	9 3/4"

HEGAR

**BM077R-BM078R**

kräftige Modelle  
heavy patterns

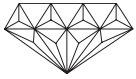

**Nadelhalter – Needle Holders**  
 DUROGRIP® Nadelhalter mit Schere  
 DUROGRIP® Needle Holders with Scissors

**BM**

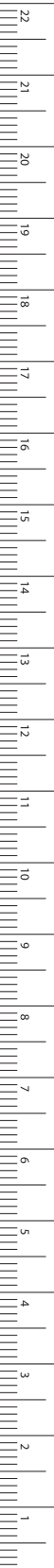

MILLIMETERS



**BM127R**

125 mm, 5"

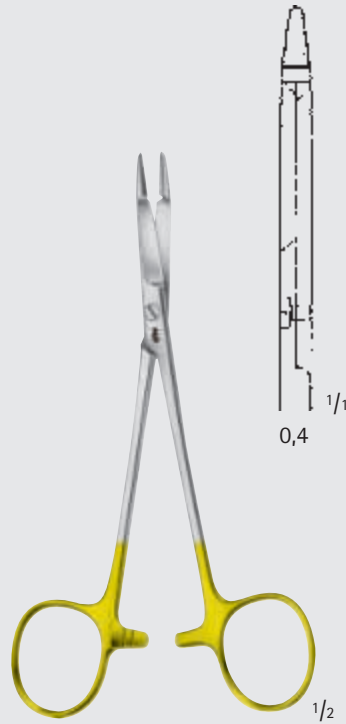

HEGAR-OLSEN MODIF. LANGE

**BM128R**

145 mm, 5 3/4"

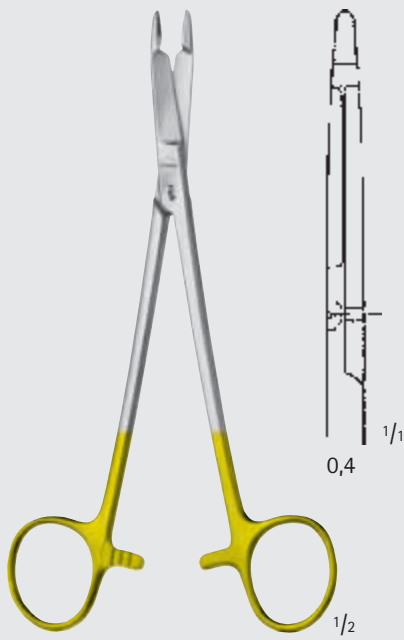

HEGAR-OLSEN

**BM124R**

1 Blatt fein gezahnt  
1 blade fine serrated  
165 mm, 6 1/2"

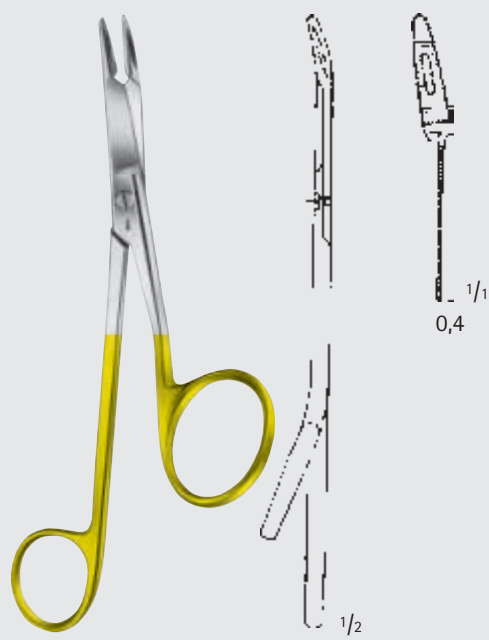

GILLIES

**BM129R**

160 mm, 6 1/4"

## Nadelhalter – Needle Holders

DUROGRIP® Nadelhalter, Drahtspannzangen, Ligaturzangen

DUROGRIP® Needle Holders, Wire Twisters, Ligature Forceps

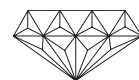

BM



**BM110R**

150 mm, 6"



**BM111R**

150 mm, 6"



**BAUMGARTNER**

**BM112R**

200 mm, 8"

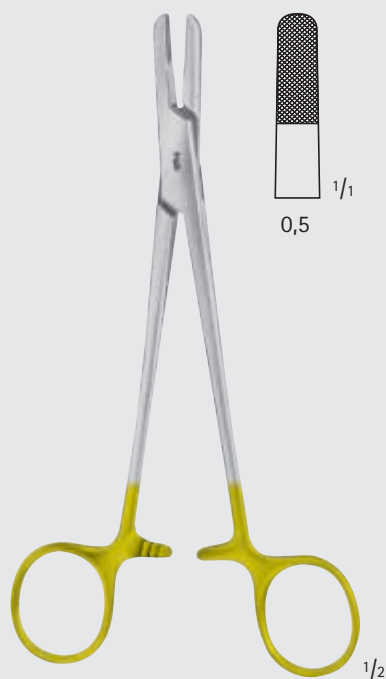

**BM113R**

175 mm, 7"

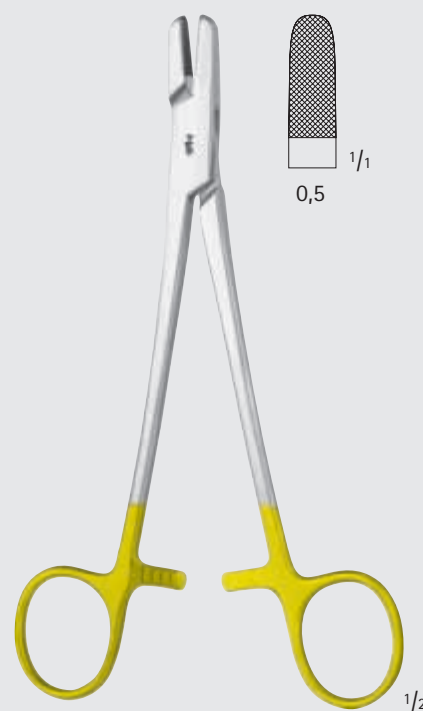

**BERRY**

**MD456R**

185 mm, 7 1/4"

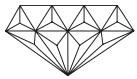

»grazil«

## Nadelhalter – Needle Holders

DUROGRIP® Nadelhalter  
DUROGRIP® Needle Holders

BM

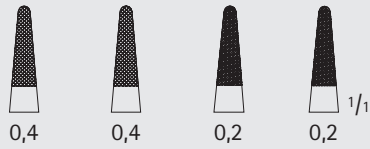

BM033R	BM034R	BM063R	BM064R
165 mm	210 mm	165 mm	210 mm
6 1/2"	8 1/4"	6 1/2"	8 1/4"

DE BAKAY

**BM033R-BM064R**

sehr fein  
very delicate

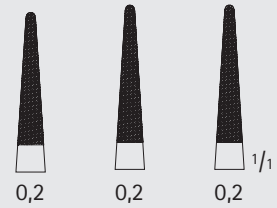

BM025R	BM026R	BM027R
180 mm	200 mm	230 mm
7"	8"	9"

**BM025R-BM027R**

sehr fein  
very delicate

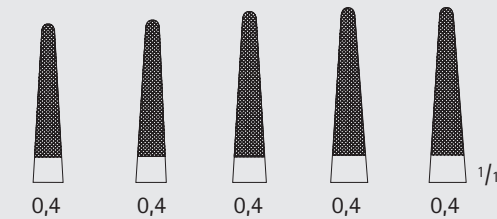

BM032R	BM035R	BM036R	BM037R	BM038R
150 mm	180 mm	230 mm	250 mm	305 mm
6"	7"	9"	10"	12"

DE BAKAY

**BM032R-BM038R**

1/2



MILLIMETERS

## Nadelhalter – Needle Holders

DUROGRIP® Nadelhalter

DUROGRIP® Needle Holders

»grazil«

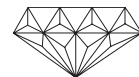

BM

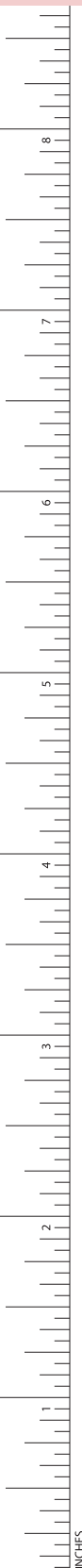

DE BAKEY

**BM040R**

schlankes Modell  
slender pattern

305 mm, 12"



DE BAKEY

**BM051R-BM052R**

Ringe griffgünstig abgesetzt  
und gebogen  
one extended handle and curved  
rings ensure optimum grip

BM051R	BM052R
195 mm	245 mm
7 3/4"	9 3/4"



**Nadelhalter – Needle Holders**  
**DUROGRIP® Nadelhalter**  
**DUROGRIP® Needle Holders**

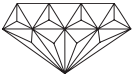

BM100R	BM101R	BM102R
200 mm	240 mm	300 mm
8"	9 1/2"	12"

**WERTHEIM**  
**BM100R-BM102R**

BM095R	BM096R
210 mm	230 mm
8 1/4"	9"

**STRATTE**  
**BM095R-BM096R**

BM081R	BM084R
200 mm	260 mm
8"	10 1/4"

**HEANEY**  
**BM081R-BM084R**

**BM082R**  
 S-förmig gebogen  
 S-shaped  
 215 mm, 8 1/2"

**BM**

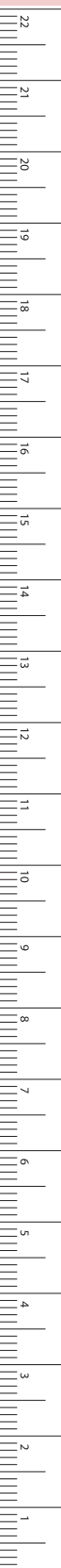

MILLIMETERS

## Nadelhalter – Needle Holders

DUROGRIP® Nadelhalter

DUROGRIP® Needle Holders

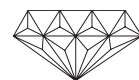

BM







**Nadelhalter – Needle Holders**  
DUROGRIP® Nadelhalter  
DUROGRIP® Needle Holders

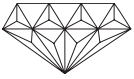

**BM**

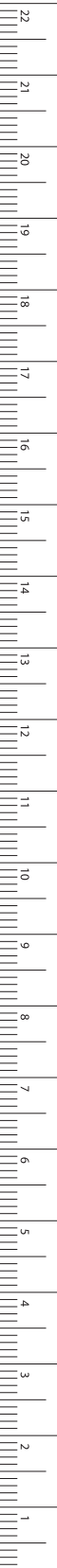

MILLIMETERS



NAUNTUN-MORGAN

**BM088R**

260 mm, 10 1/2"



MÜLLER

**BM089R**

für tiefe Rektumchirurgie  
for deep rectum surgery  
360 mm, 14"

## Nadelhalter – Needle Holders

DUROGRIP® Nadelhalter

DUROGRIP® Needle Holders

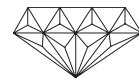

BM



MASSON

**BM090R**

265 mm, 10 1/2"



FINOCHIETTO

**BM092R**

265 mm, 10 1/2"



## Nadelhalter – Needle Holders

### DUROGRIP® Nadelhalter

### DUROGRIP® Needle Holders

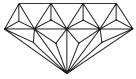

Diese Spezialmodelle mit extra schmalen Mäulern eignen sich für atraumatische Nadeln und für feine Gefäßnadeln.

These special patterns with extremely fine jaws are suitable for holding non-traumatic needles and fine vein needles.

**BM**



BM074R	BM075R	BM076R
150 mm	180 mm	230 mm
6"	7"	9"

**RYDER**

**BM074R-BM076R**

mit glattem Maul  
with smooth jaws



1/2

**BM184R**

200 mm, 8"

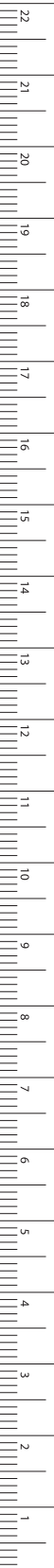

MILLIMETERS

## Nadelhalter – Needle Holders

DUROGRIP® Nadelhalter

DUROGRIP® Needle Holders

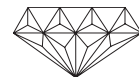

Diese Spezialmodelle mit extra schmalen Mäulern eignen sich für atraumatische Nadeln und für feine Gefäßnadeln.

These special patterns with extremely fine jaws are suitable for holding non-traumatic needles and fine vein needles.

»grazil«

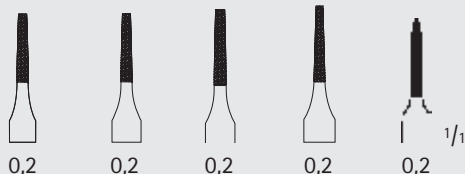

BM054R	BM055R	BM056R	BM057R	BM058R
135 mm	155 mm	175 mm	210 mm	230 mm
5 1/4"	6"	7"	8 1/4"	9"

RYDER

**BM054R-BM058R**

sehr fein

very delicate

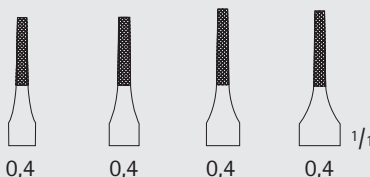

BM044R	BM045R	BM046R	BM047R
135 mm	175 mm	195 mm	265 mm
5 1/4"	7"	7 3/4"	10 1/2"

RYDER

**BM044R-BM047R**

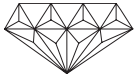

## Nadelhalter – Needle Holders

DUROGRIP® Nadelhalter, ergonomische Griff-Form  
DUROGRIP® Nadelhalter, Ergonomic Handle

Diese Instrumente bieten dem Chirurgen ein Maximum an ergonomischem Komfort. Das optimierte Design der Instrumente ermöglicht ein ermüdungsfreies Arbeiten insbesondere bei schwierigen Naht- und Anastomostechiken.

These instruments provide the surgeon with a maximum of ergonomic comfort. The optimized design of the Instruments offers a fatigue-free working especially with regard to difficult suture and anastomosis techniques.

**BM**

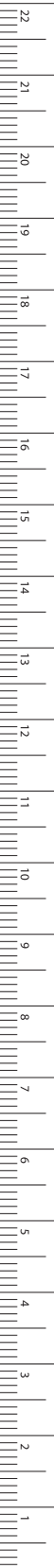

MILLIMETERS

**HELLBERG-KUPKA**  
**BM320R**  
mit Anreicherungssperre  
with locking ratchet  
210 mm, 8 1/4"

**REIN-KUPKA**  
**BM310R**  
ohne Sperre  
without ratchet  
190 mm, 7 1/2"

**REIN-KUPKA**  
**BM311R**  
mit Sperre  
with ratchet  
190 mm, 7 1/2"

## Nadelhalter – Needle Holders

DUROGRIP® Nadelhalter

DUROGRIP® Needle Holders

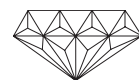

BM



1/2

TÖNNIS

**BM186R**

elastisches Modell

elastic pattern

180 mm, 7"



1/2

TÖNNIS MODIF.

**BM183R**

elastisches Modell

elastic pattern

180 mm, 7"

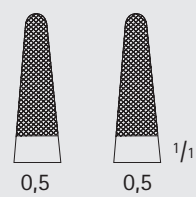

BM191R	BM193R
180 mm	200 mm
7"	8"

LANGENBECK

**BM191R-BM193R**



1/2

»grazil«

LANGENBECK

**BM196R**

200 mm, 8"



**Nadelhalter – Needle Holders**  
 DUROGRIP® Nadelhalter  
 DUROGRIP® Needle Holders

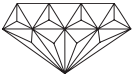

**BM**

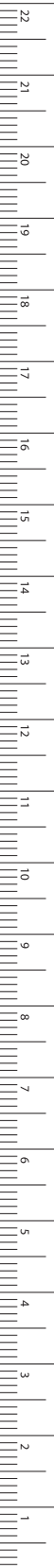

MILLIMETERS



ZWEIFEL

**BM170R**

200 mm, 8"



ZWEIFEL

**BM172R**

200 mm, 8"

kräftiges Modell  
für Sternumnaht  
heavy pattern  
for sternum suture



AESCALAP

**BM178R**

200 mm, 8"

## Nadelhalter – Needle Holders

DUROGRIP® Nadelhalter

DUROGRIP® Needle Holders

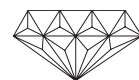

BM



»grazil«



LICHTENBERG

**BM132R**

elastisches Modell  
elastic pattern

195 mm, 7 3/4"



**BM165R**

mit langem Hals  
with long neck  
205 mm, 8"



HÖSEL

**BM168R**

mit langem Hals  
with long neck  
260 mm, 10"





**Nadelhalter – Needle Holders**  
**DUROGRIP® Nadelhalter**  
**DUROGRIP® Needle Holders**

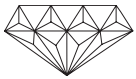

»grazil«

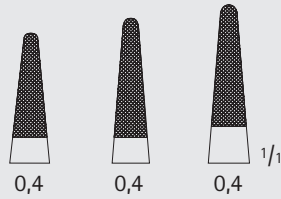

BM148R	BM150R	BM153R
140 mm	170 mm	200 mm
5 1/2"	6 3/4"	8"

MATHIEU

**BM148R-BM153R**

feine Modelle  
 delicate patterns

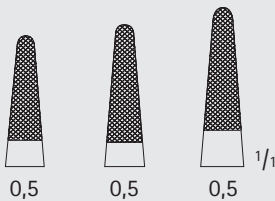

BM149R	BM151R	BM154R
140 mm	170 mm	200 mm
5 1/2"	6 3/4"	8"

MATHIEU

**BM149R-BM154R**

Standard-Modelle  
 Standard patterns

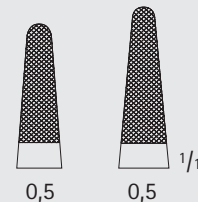

BM156R	BM158R
200 mm	245 mm
8"	9 3/4"

MATHIEU

**BM156R-BM158R**

kräftige Modelle  
 heavy patterns

**BM**

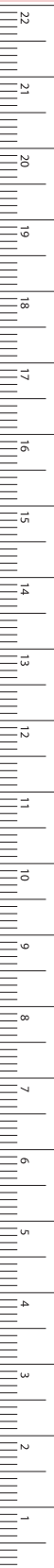

MILLIMETERS

## Nadelhalter – Needle Holders

Bumerang-Nadelhalter

Boomerang Needle Holders

BM



**BM627R**



**BM628R**



**BM629R**

**BM627R–BM629R**

Ersatz-Nadeln

Spare needles



1/2

**YOUNG-HRYNTSCHAK**

**BM620R**

Bumerang-Nadelhalter  
mit 1 Nadel BM627R  
Boomerang Needle Holder  
with 1 needle BM627R  
240 mm, 9 1/2"



1/2

**MILLIN**

**EF168R**

Fadenhaltezange  
Ligature holding forceps  
285 mm, 9 3/4"



**Nadelhalter – Needle Holders**  
Naht-Instrumente – Reverdin-Nadeln  
Suture Instruments – Reverdin Needles

**BM**



**BM711R**



**BM712R**



**BM713R**



**BM714R**

REVERDIN

**BM711R-BM714R**

195 mm, 7 3/4"

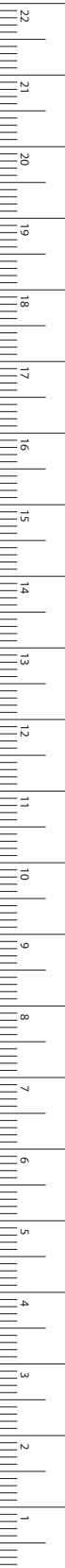

**Nadelhalter – Needle Holders**  
Naht-Instrumente - Reverdin-Nadeln  
Suture Instruments - Reverdin Needles

BM

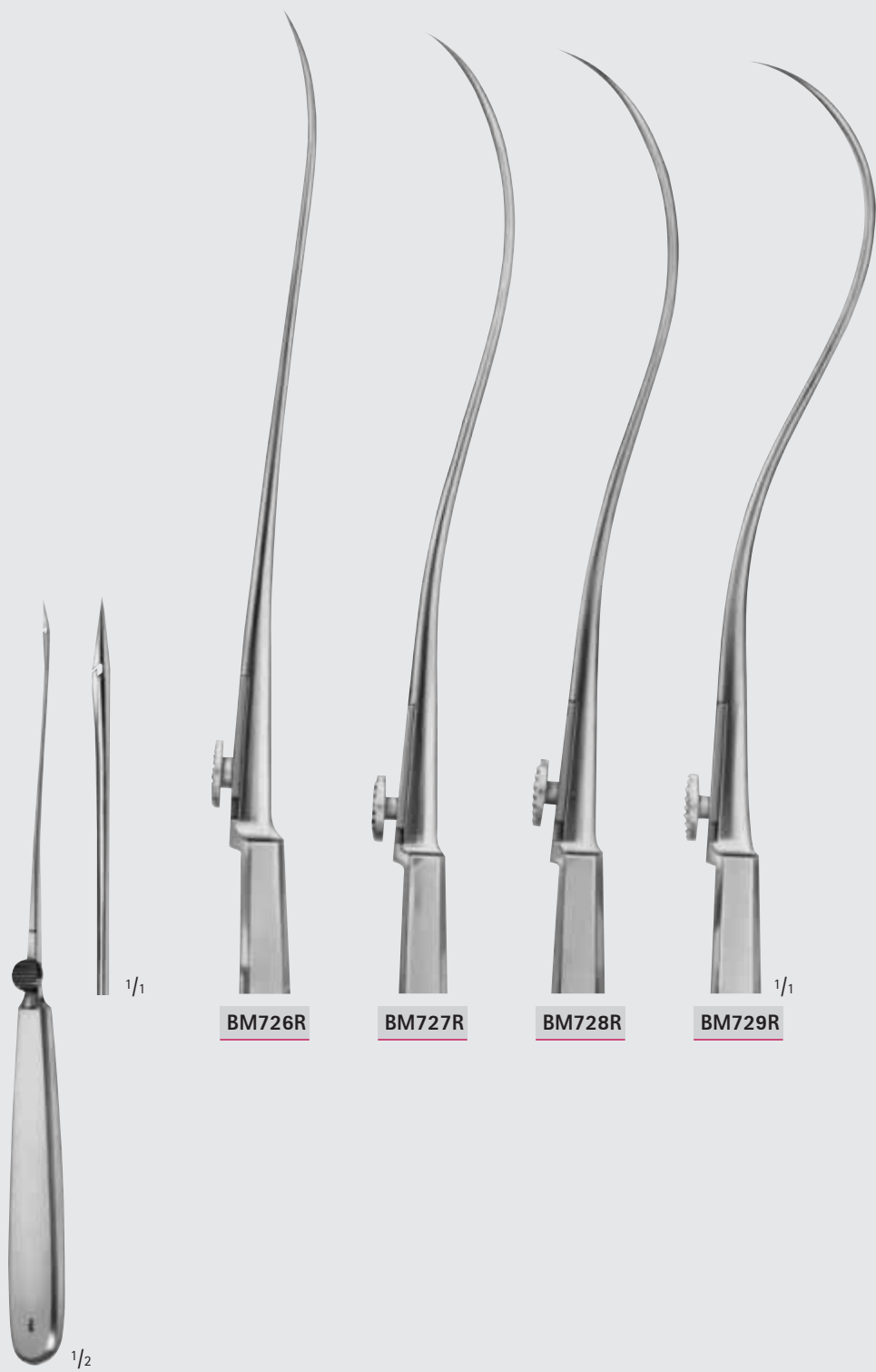

BM726R

BM727R

BM728R

BM729R

1/1

1/2

REVERDIN

**BM726R-BM729R**

220 mm, 8 3/4"



**Nadelhalter – Needle Holders**  
 Naht-Instrumente - Unterbindungsnadeln  
 Suture Instruments - Ligature Needles

**BM**

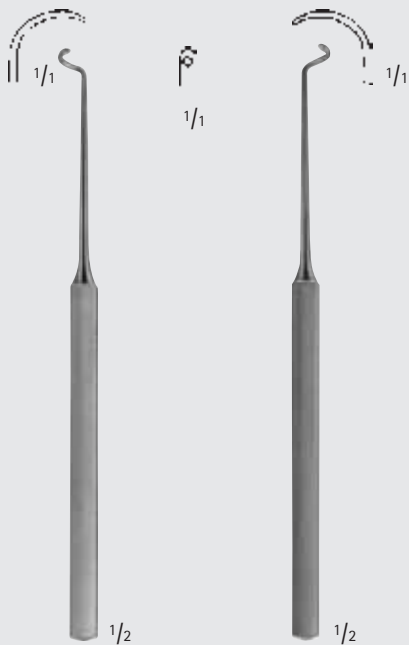
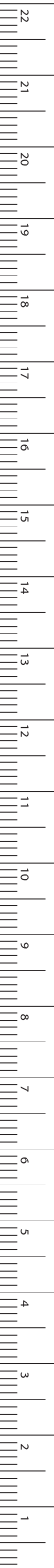

**KRONECKER**

**BM801R**

für rechte Hand  
stumpf  
for right hand  
blunt  
155 mm, 6"



**KRONECKER**

**BM802R**

für linke Hand  
stumpf  
for left hand  
blunt  
155 mm, 6"



**DESCHAMPS**

**BM812R**

für rechte Hand  
steile Biegung  
stumpf  
for right hand  
steep turn  
blunt  
225 mm, 9"



**DESCHAMPS**

**BM813R**

für linke Hand  
steile Biegung  
stumpf  
for left hand  
steep turn  
blunt  
225 mm, 9"



**DESCHAMPS**

**BM814R**

für rechte Hand  
steile Biegung  
stumpf  
for right hand  
steep turn  
blunt  
225 mm, 9"

MILLIMETERS

**Nadelhalter – Needle Holders**  
 Naht-Instrumente - Unterbindungsnadeln  
 Suture Instruments - Ligature Needles

**BM**



**DESCHAMPS**  
**BM806R**  
 für rechte Hand  
 stumpf  
 for right hand  
 blunt  
 215 mm, 8 1/2"



**DESCHAMPS**  
**BM807R**  
 für linke Hand  
 stumpf  
 for left hand  
 blunt  
 215 mm, 8 1/2"



**DESCHAMPS**  
**BM808R**  
 für rechte Hand  
 stumpf  
 for right hand  
 blunt  
 210 mm, 8 1/4"



**DESCHAMPS**  
**BM809R**  
 für linke Hand  
 stumpf  
 for left hand  
 blunt  
 210 mm, 8 1/4"



**Nadelhalter – Needle Holders**  
 Naht-Instrumente - Unterbindungsnadeln  
 Suture Instruments - Ligature Needles

**BM**

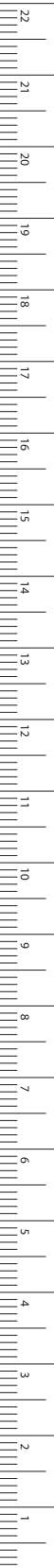

MILLIMETERS

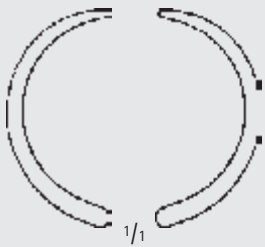

1/1

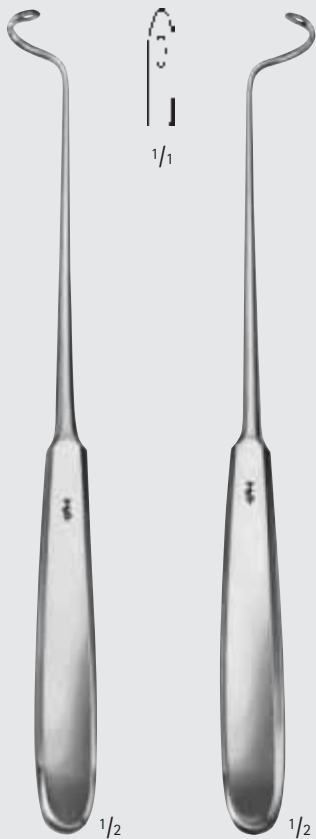

1/1

1/2

1/2

DESCHAMPS

**BM810R**

für rechte Hand  
 stumpf  
 for right hand  
 blunt  
 215 mm, 8 1/2"

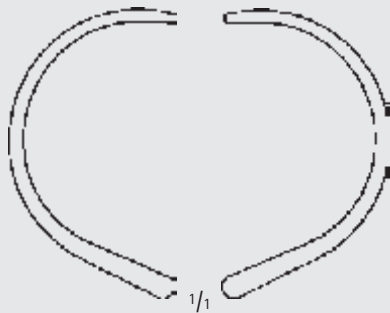

1/1

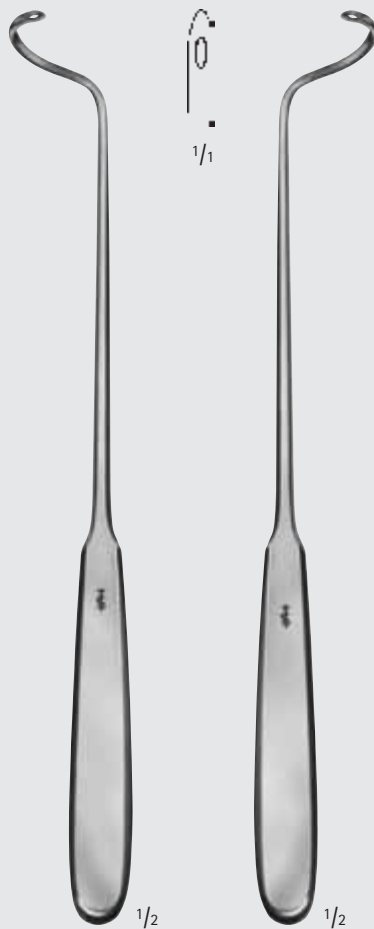

1/1

1/2

1/2

DESCHAMPS

**BM822R**

für rechte Hand  
 stumpf  
 for right hand  
 blunt  
 240 mm, 9 1/2"

DESCHAMPS

**BM823R**

für linke Hand  
 stumpf  
 for left hand  
 blunt  
 240 mm, 9 1/2"

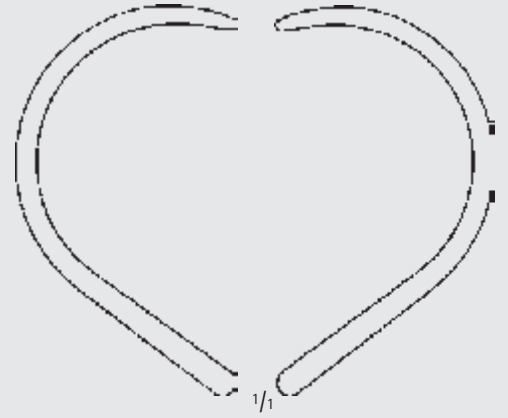

1/1

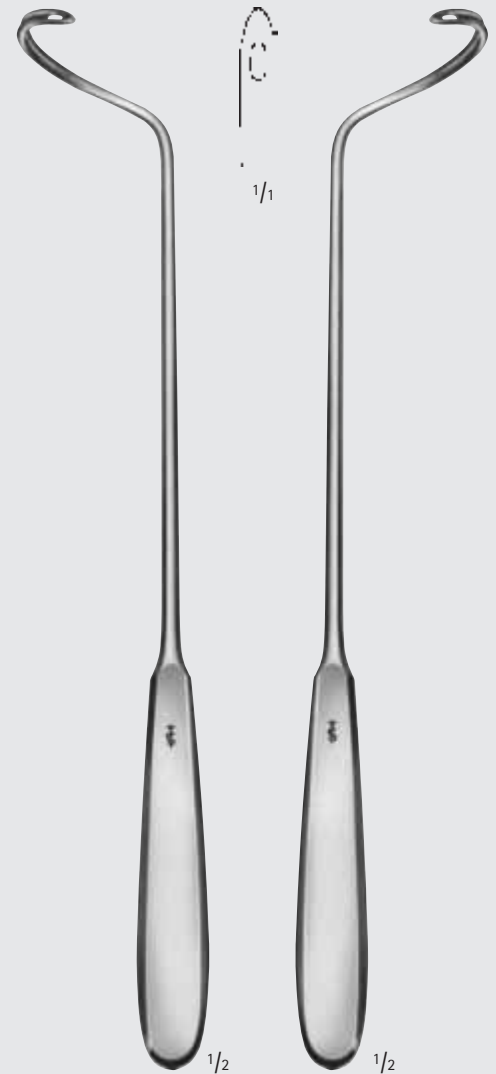

1/1

1/2

1/2

DESCHAMPS

**BM824R**

für rechte Hand  
 stumpf  
 for right hand  
 blunt  
 280 mm, 11"

DESCHAMPS

**BM825R**

für linke Hand  
 stumpf  
 for left hand  
 blunt  
 280 mm, 11"

**Nadelhalter – Needle Holders**  
 Naht-Instrumente - Unterbindungsnadeln  
 Suture Instruments - Ligature Needles

**BM**



**HURD**  
**BM770R**  
 für rechte Hand  
 scharf  
 for right hand  
 sharp  
 210 mm, 8 1/4"

**HURD**  
**BM771R**  
 für linke Hand  
 scharf  
 for left hand  
 sharp  
 210 mm, 8 1/4"



**DESCHAMPS**  
**BM780R**  
 für rechte Hand  
 scharf  
 for right hand  
 sharp  
 210 mm, 8 1/4"

**DESCHAMPS**  
**BM781R**  
 für linke Hand  
 scharf  
 for left hand  
 sharp  
 210 mm, 8 1/4"





**Nadelhalter – Needle Holders**  
 Naht-Instrumente - Unterbindungsnadeln  
 Suture Instruments - Ligature Needles

**BM**

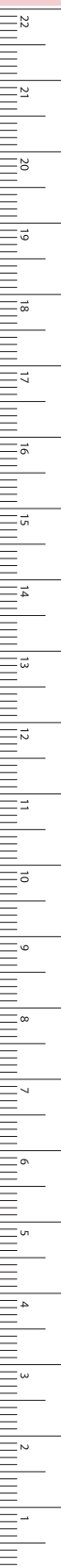

MILLIMETERS

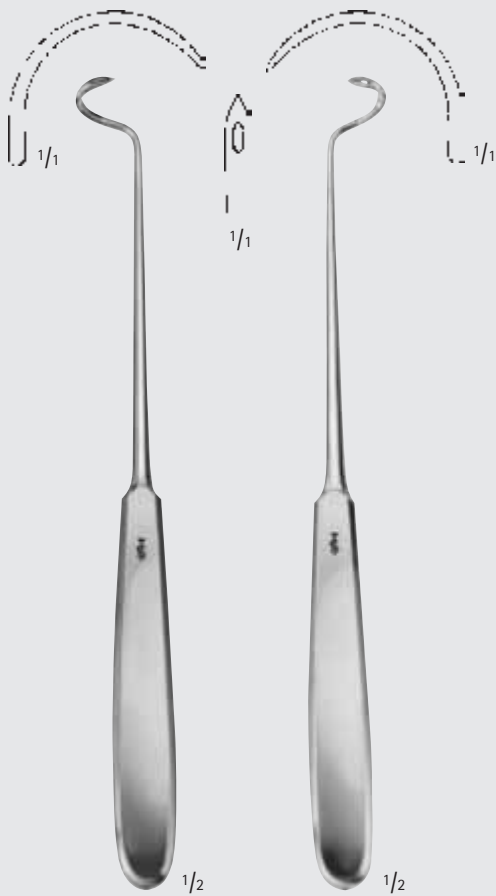

**DESCHAMPS**

**BM748R**

für rechte Hand  
 scharf  
 for right hand  
 sharp  
 215 mm, 8 1/2"

**DESCHAMPS**

**BM749R**

für linke Hand  
 scharf  
 for left hand  
 sharp  
 215 mm, 8 1/2"



**JONESCO**

**BM755R**

Hohlnadel  
 Needle for wire suture  
 185 mm, 7 1/4"



**CLAUS VAN EICKEN**

**BM774R**

250 mm, 10"

## Nadelhalter – Needle Holders

Unterbindungsnadeln

Ligature Needles

BM

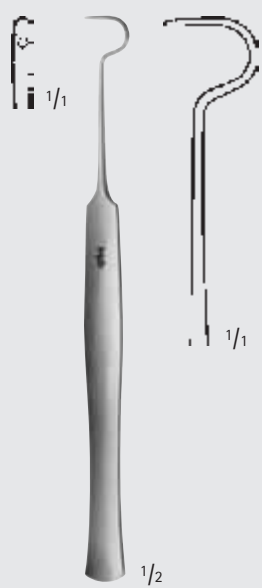

**BM853R**

150 mm, 6"

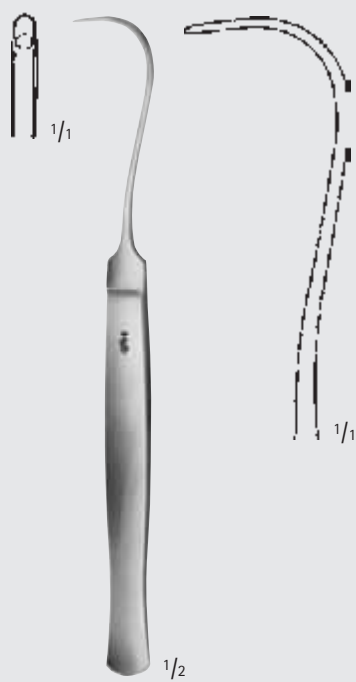

**SYME**

**BM855R**

170 mm, 6 3/4"

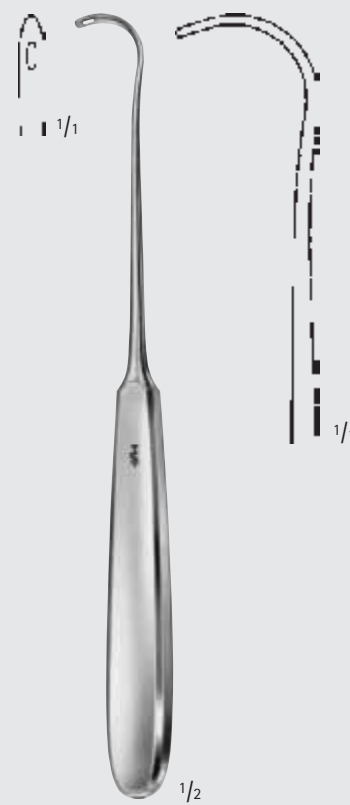

**COOPER**

**BM856R**

205 mm, 8"



**Nadelhalter – Needle Holders**  
Unterbindungsnadeln  
Ligature Needles

**BM**

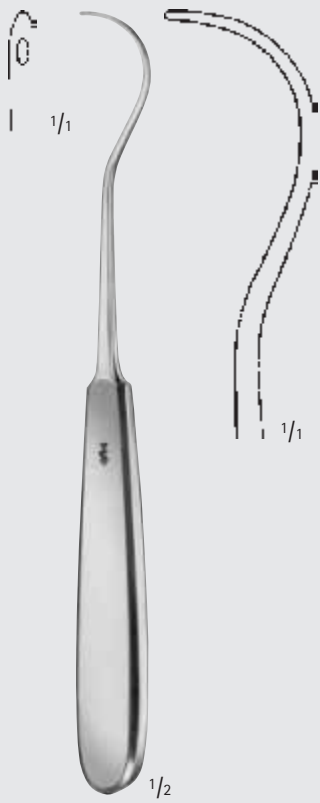

**KOCHER**

**BM858R**

205 mm, 8"

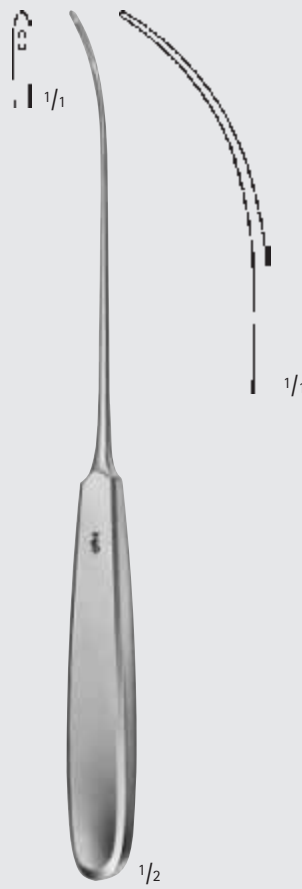

**BM861R**

biegsam  
malleable  
230 mm, 9"

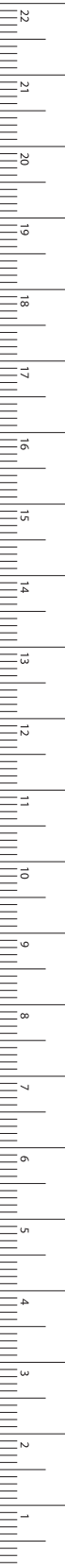

MILLIMETERS

## Nadelhalter – Needle Holders

Unterbindungs-nadeln, Führungs-Hohlsonden nach BRUNNER

BRUNNER Ligature Needles, Guiding Probes

BM

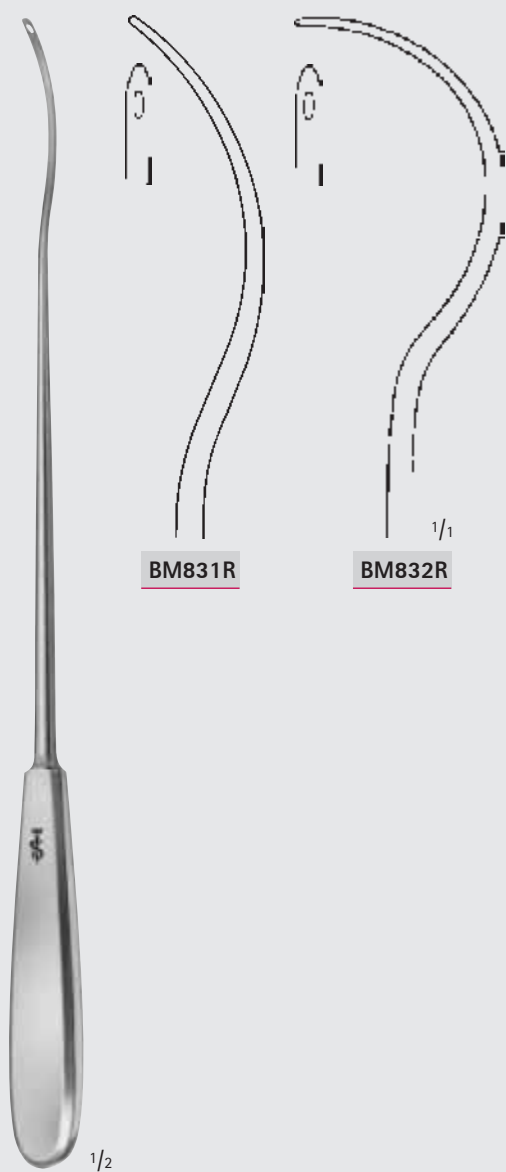

BM831R

BM832R

BRUNNER

**BM831R-BM832R**

Unterbindungs-nadeln

Ligature needles

300 mm, 12"

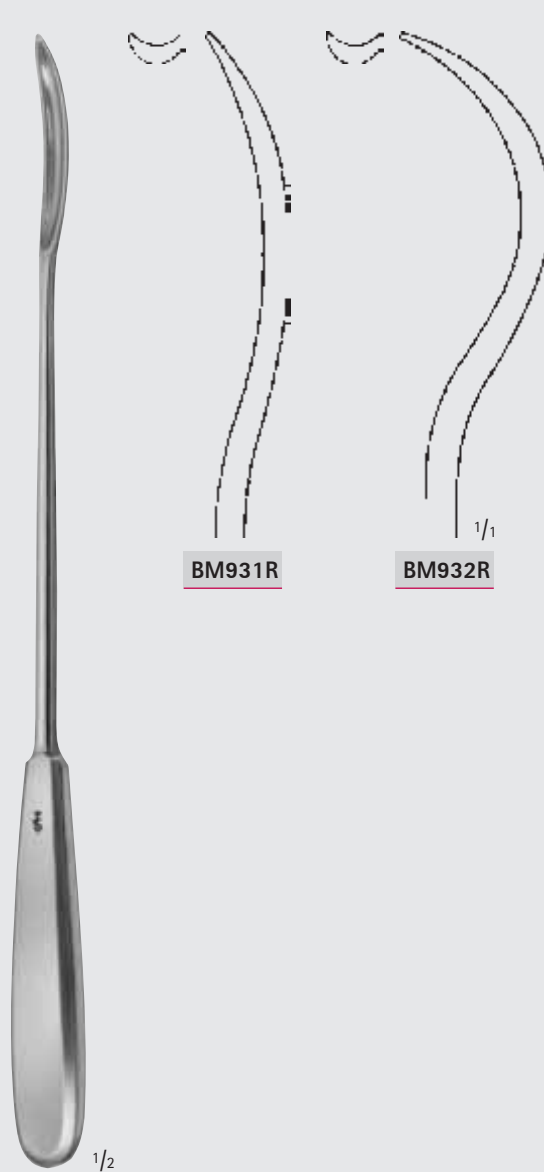

BM931R

BM932R

BRUNNER

**BM931R-BM932R**

Führungs-Hohlsonden

Guiding probes

300 mm, 12"



**Nadelhalter – Needle Holders**  
 Führungs-Hohlsonden  
 Guiding Probes

**BM**

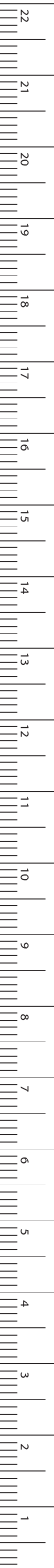

3 mm

1/2

1/1

**BM900R**  
 200 mm, 8"

5 mm

1/2

1/1

**KÖNIG**  
**BM901R**  
 195 mm, 7 3/4"

7 mm

1/2

1/1

**KÖNIG**  
**BM902R**  
 200 mm, 8"

8 mm

1/2

1/1

**SCHMIEDEN**  
**BM905R**  
 185 mm, 7 1/4"

11 mm

1/2

1/1

**KOCHER**  
**BM911R**  
 150 mm, 6"

12 mm

1/2

1/1

**KOCHER**  
**BM913R**  
 170 mm, 6 3/4"

5 mm

1/2

1/1

**PAYR**  
**BM920R**  
 195 mm, 7 3/4"

5 mm

1/2

1/1

**PAYR**  
**BM922R**  
 225 mm, 9"

MILLIMETERS

## Nadelhalter – Needle Holders

Führungs-Hohlsonden

Guiding Probes

Aus Kunststoff, zur Koagulation sterilisierbar im Autoklav bis 143 °C (3 bar)

Of plastic material, can be sterilized in an autoclave up to 143 °C (3 bar)

BM

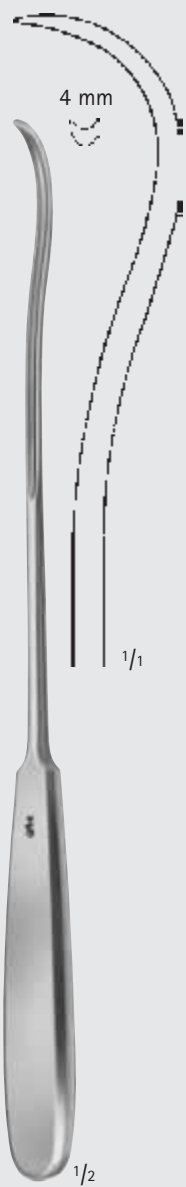
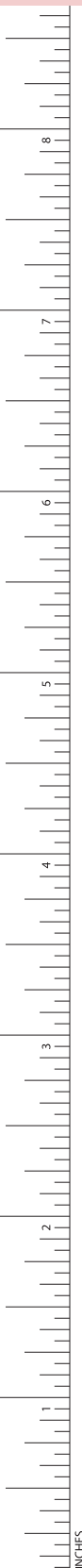

**BM924R**

280 mm, 11"

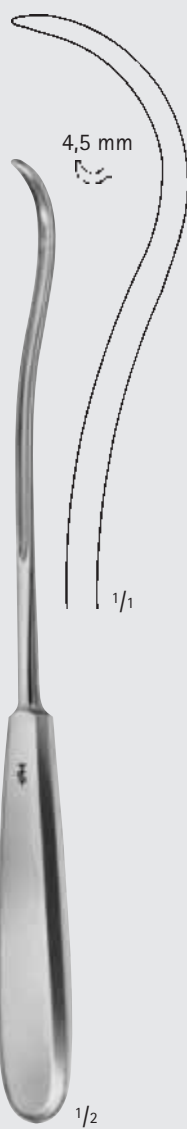

**KIRSCHNER**

**BM925R**

255 mm, 10"



**BM938**

240 mm, 9 1/2"

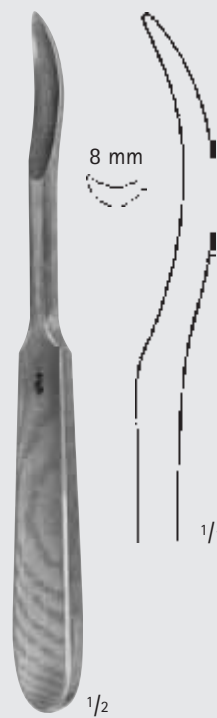

**BM940**

185 mm, 7 1/4"



**BM941**

265 mm, 10 1/2"



## Nadelhalter – Needle Holders

Instrumente zur Naht  
Suture Instruments

BM



**BM950R**

Fadengabel  
Knot tier and Ligature adjuster  
230 mm, 9"



**CASPAR**

**FF309**

Fadengabel  
Knot tier and Ligature adjuster  
230 mm, 9"

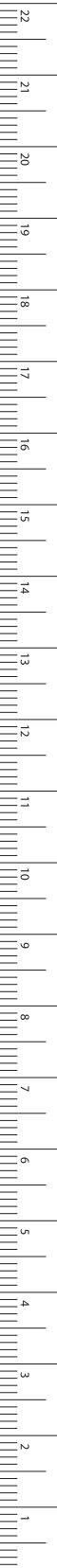

MILLIMETERS

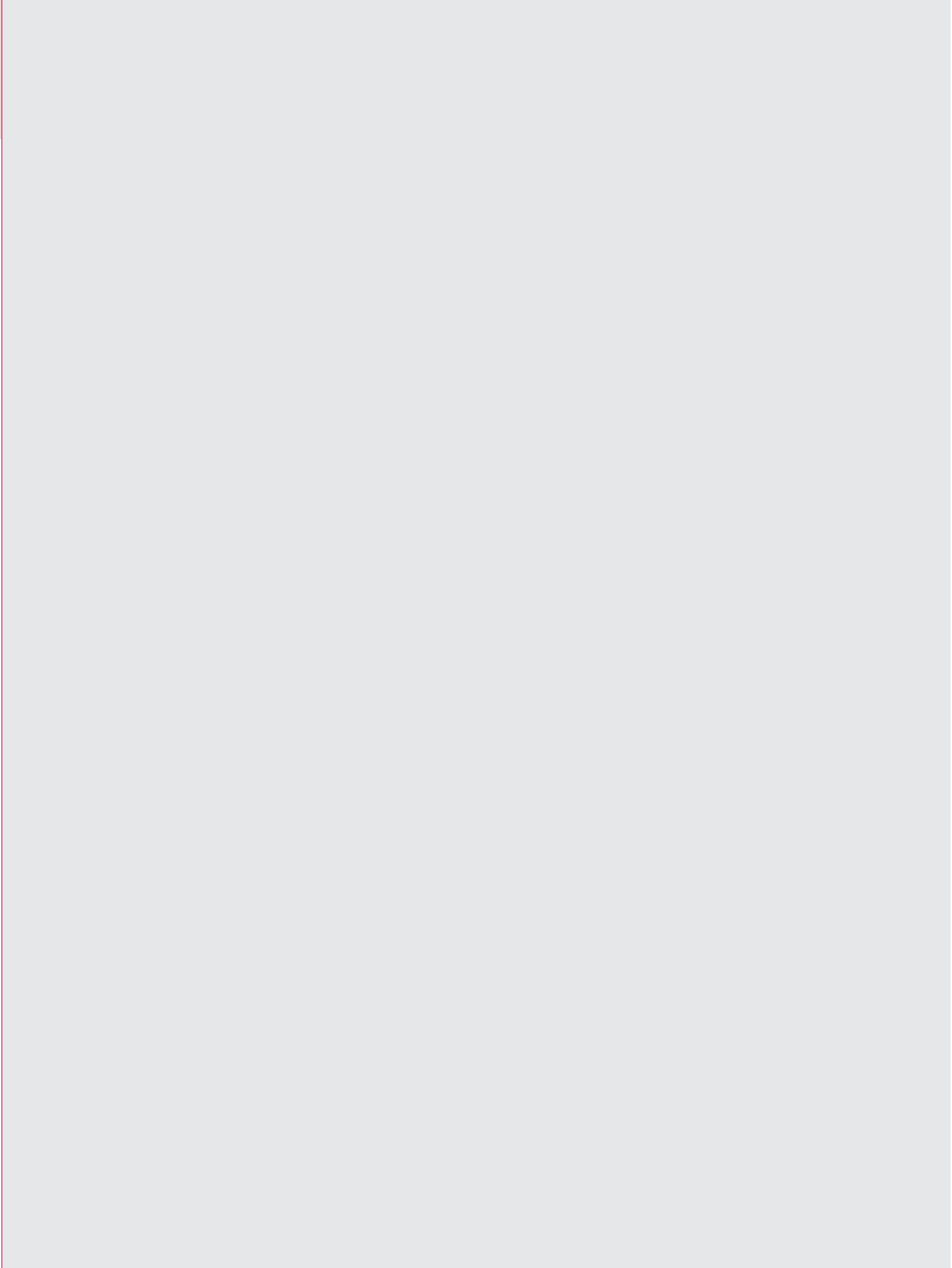





**BN**



**Sonden, Watteträger, Wundklammern**

Probes, Cotton Applicators, Suture Clips

## Sonden – Probes

Sonden  
Probes

BN

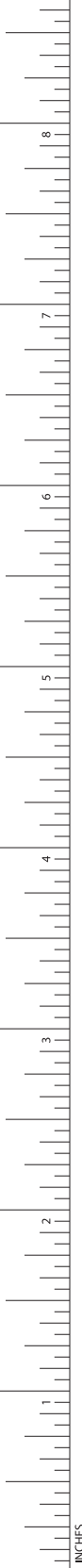

**BN003R** 130 mm, 5 1/8"

**BN004R** 145 mm, 5 3/4"

**BN006R** 160 mm, 6 1/4"

Hohlsonden  
Directors

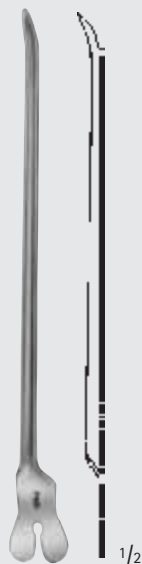

DOYEN

**BN010R**

Hohlsonde

Director

145 mm, 5 3/4"

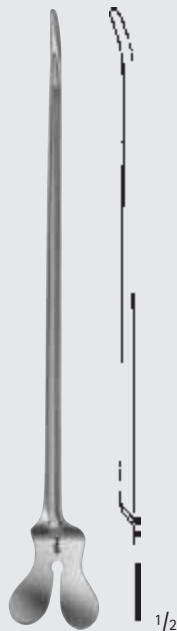

NELATON

**BN012R**

Hohlsonde

Director

160 mm, 6 1/4"



Knopf-Ø 3,3 mm

Diam. of tip 3.3 mm

**BN015R**

Hohlsonde mit Knopf

Director with tip

140 mm, 5 1/2"

Knopf-Ø 3,5 mm  
Diam. of tip 3.5 mm

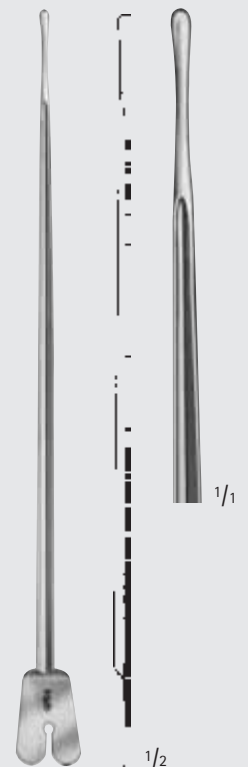

BRODIE

**BN020R**

Hohlsonde mit Knopf

Director with tip

200 mm, 8"



Sonden – Probes  
Sonden  
Probes

BN

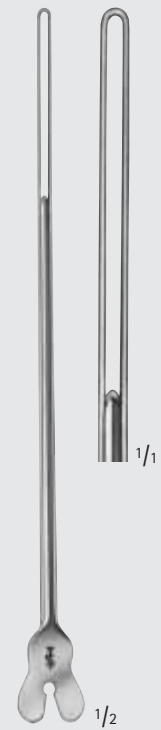
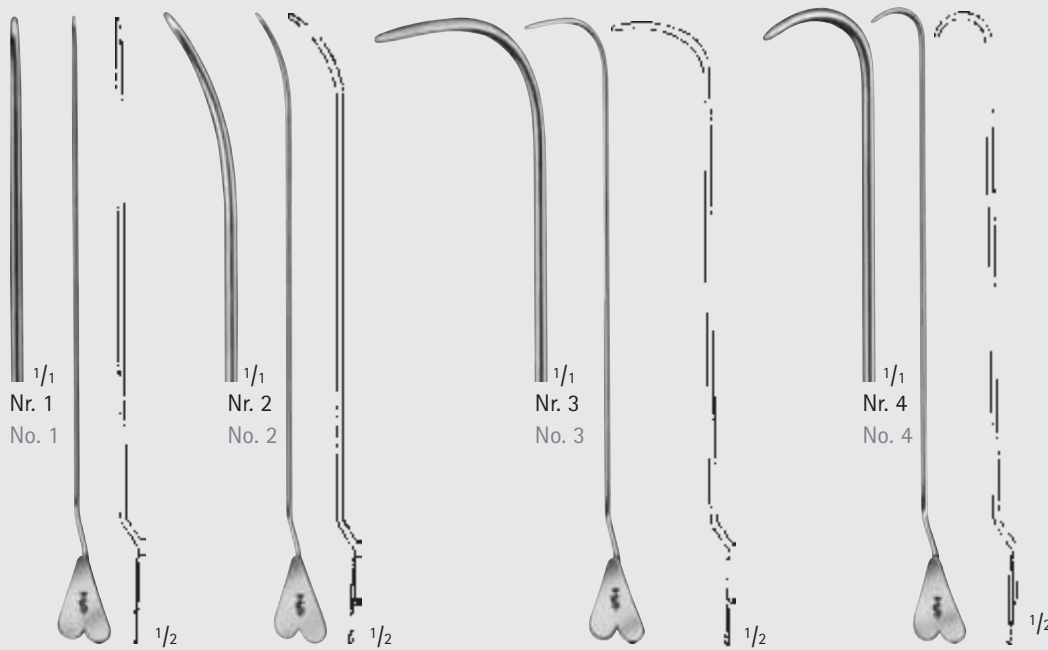

LOCKHART-MUMMERY

<b>BN021R</b>	Nr. 1 gerade	No. 1 straight
<b>BN022R</b>	Nr. 2 45° gebogen	No. 2 45° curved
<b>BN023R</b>	Nr. 3 90° gebogen	No. 3 90° curved
<b>BN024R</b>	Nr. 4 retrograd gebogen	No. 4 retrograde curved

Fistelsonden  
Fistula probes  
165 mm, 6 1/2"

**BN026R**  
Ösenrinnensonde,  
biegsam  
Director with wire loop,  
malleable  
190 mm, 7 1/2"

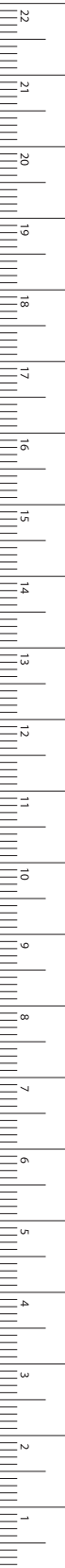

MILLIMETERS

## Sonden – Probes

Sonden

Probes

BN



Knopf-Ø  
Diam.  
of tip

<b>BN034R</b>	145 mm, 5 3/4"	2,5 mm
<b>BN036R</b>	160 mm, 6 1/4"	2,5 mm
<b>BN040R</b>	200 mm, 8"	3,0 mm

### BN034R-BN040R

Öhrsonden

Probes with eye



1/2

### MB603R

125 mm, 5"

Knopf-Ø 1,5 mm  
Diam. of tip 1.5 mm



1/2

### BN054R

Myrtenblattsonde

Myrtle leaf probe

145 mm, 5 3/4"

Knopf-Ø 2,0 mm  
Diam. of tip 2.0 mm

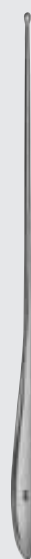

**BN063R** 130 mm, 5 1/8"

**BN064R** 145 mm, 5 3/4"

**BN066R** 160 mm, 6 1/4"

**BN068R** 180 mm, 7"

**BN070R** 200 mm, 8"

Myrtenblattsonden

Myrtle leaf probes



Sonden – Probes  
Sonden  
Probes

BN

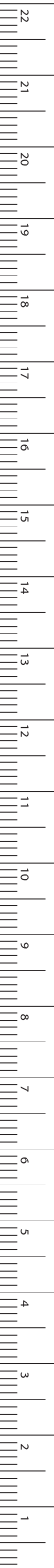

MILLIMETERS



Knopf-Ø Diam. of tip			Länge Length
1,0 mm	1,5 mm	2,0 mm	
	<b>BN113R</b>		130 mm, 5 1/8"
<b>BN104R</b>	<b>BN114R</b>	<b>BN134R</b>	145 mm, 5 3/4"
	<b>BN116R</b>	<b>BN136R</b>	160 mm, 6 1/4"
	<b>BN118R</b>	<b>BN138R</b>	180 mm, 7"
	<b>BN120R</b>	<b>BN140R</b>	200 mm, 8"
	<b>BN125R</b>		250 mm, 10"
		<b>BN150R</b>	300 mm, 12"

**BN104R-BN150R**

Knopfsonden  
Probes

Knopf-Ø 1,2 mm  
Diam. of tip 1.2 mm



1/2

**BN110**

Sinus-Knopfsonde  
Sinus probe  
150 mm, 6"

Knopf-Ø 3,0 mm  
Diam. of tip 3.0 mm

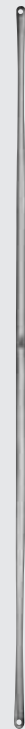

1/2

**BN090R**

Doppelknopfsonde,  
biegsam, mit Loch  
Double ended probe,  
malleable, with hole  
190 mm, 7 1/2"

## Sonden – Probes

Sonden

Probes

BN



Knopf-Ø 3,5 mm  
Diam. of tip 3.5 mm



**BN095** 250 mm, 10"

**BN096** 300 mm, 12"

Doppelknopfsonden,  
Zinn, biegsam  
Double ended probes,  
tin, malleable

Knopf-Ø 4,0 mm  
Diam. of tip 4.0 mm



**BN099**

Doppelknopfsonde,  
Zinn, biegsam  
Double ended probe,  
tin, malleable  
400 mm, 16"

Knopf-Ø 2,0 mm  
Diam. of tip 2.0 mm



**BN101R**

Knopfsonde  
Probe  
300 mm, 12"



Sonden – Probes  
Sonden  
Probes

BN

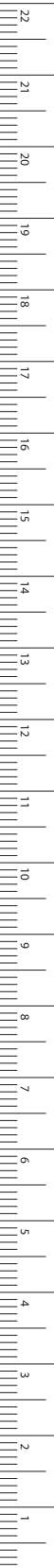

MILLIMETERS

Ø 0,8 mm  
Diam. 0.8 mm



STACKE

**BN160**

Silber  
silver  
100 mm, 4"



CAWTHORNE

**BN161**

flaches Ende  
Silber  
flattened end  
silver  
140 mm, 5 1/2"

Ø 1,5 mm  
Diam. 1.5 mm



KILLIAN

**BN172R**

165 mm, 6 1/2"

Ø 1,4 mm  
Diam. 1.4 mm



**BN170R**

160 mm, 6 1/4"

Ø 1,0 mm  
Diam. 1.0 mm



SEIFFERT

**OM488**

Silber  
silver  
195 mm, 7 3/4"



BOWMAN

**OB510-OB514**

Neusilber  
German silver  
130 mm, 5 1/8"

Ø  
Diam.

<b>OB510</b>	0,7 + 0,8 mm	Fig. 00/0
<b>OB511</b>	0,9 + 1,1 mm	Fig. 1/2
<b>OB512</b>	1,3 + 1,4 mm	Fig. 3/4
<b>OB513</b>	1,5 + 1,6 mm	Fig. 5/6
<b>OB514</b>	1,8 + 1,9 mm	Fig. 7/8

**Sonden – Probes**  
 Spatel – Watteträger  
 Spatulas – Cotton Applicators

**BN**



1/2

**BN184R**

Spatel  
 Spatula  
 145 mm, 5 3/4"



16 mm

1/2

**OM202R**

Spatel  
 Spatula  
 145 mm, 5 3/4"

Ø 0,7 mm  
 Diam. 0.7 mm



1/1

1/2

**MODELL PICCOLO**

**OF261R**

rund gerieft  
 round serrated end  
 110 mm, 4 1/2"

Ø 0,7 mm  
 Diam. 0.7 mm



1/1

1/2

**MODELL PICCOLO**

**OF262R**

dreikant gerieft  
 triangular serrated end  
 110 mm, 4 1/2"

Ø 1,2 mm  
 Diam. 1.2 mm



1/1

1/2

**FARRELL**

**OF257R**

rund gerieft  
 round serrated end  
 110 mm, 4 1/2"

Ø 1,4 mm  
 Diam. 1.4 mm



1/1

1/2

**LATHBURY-FARRELL**

**OF259R**

dreikant gerieft  
 triangular serrated end  
 110 mm, 4 1/2"





**Sonden – Probes**  
Watteträger  
Cotton Applicators

**BN**

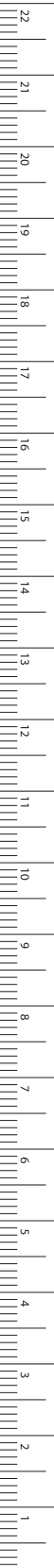

MILLIMETERS

Ø 0,9 mm  
Diam. 0.9 mm



**BUCK**

**BN400R**

spiralförmig gerieft  
rough, spiral end  
120 mm, 4 3/4"

Ø 0,9 mm  
Diam. 0.9 mm



**LATHBURY-FARRELL**

**BN467R**

dreikant gerieft  
triangular serrated end  
140 mm, 5 1/2"

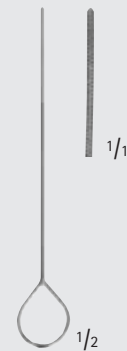

**KINGS'S COLLEGE HOSPITAL**

**BN403**

spiralförmig gerieft  
rough, spiral end  
90 mm, 3 3/8"



**KINGS'S COLLEGE HOSPITAL**

**BN404**

spiralförmig gerieft  
rough, spiral end  
135 mm, 5 1/8"

Ø 1,0 mm  
Diam. 1.0 mm



**BN440R**

spiralförmig gerieft  
rough, spiral end  
140 mm, 5 1/2"

Ø 1,2 mm  
Diam. 1.2 mm



**BN445R**

spiralförmig gerieft  
rough, spiral end  
140 mm, 5 1/2"

**Sonden – Probes**  
 Watteträger  
 Cotton Applicators

**BN**



Ø 1,2 mm  
 Diam. 1.2 mm



FARRELL

**BN460R**

rund gerieft  
 round serrated end  
 140 mm, 5 1/2"

Ø 1,4 mm  
 Diam. 1.4 mm

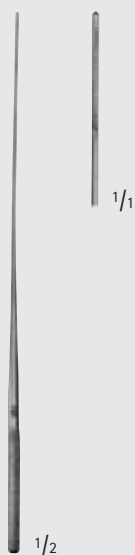

LATHBURY-FARRELL

**BN465R**

dreikant gerieft  
 triangular serrated end  
 140 mm, 5 1/2"

Ø 1,2 mm  
 Diam. 1.2 mm

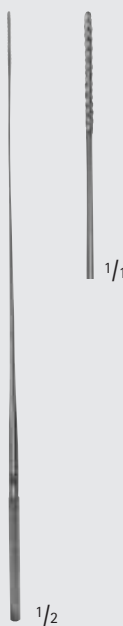

FARRELL

**BN461R**

spiralförmig gerieft  
 rough, spiral end  
 160 mm, 6 1/4"

Ø 1,2 mm  
 Diam. 1.2 mm



LATHBURY-FARRELL

**BN466R**

dreikant gerieft  
 triangular serrated end  
 160 mm, 6 1/4"

Ø 1,4 mm  
 Diam. 1.4 mm

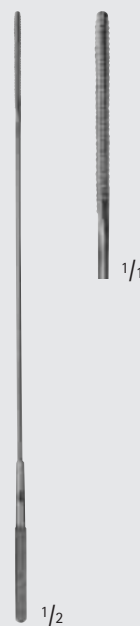

LATHBURY-FARRELL

**BN468R**

dreikant gerieft  
 triangular serrated end  
 160 mm, 6 1/4"

Ø 1,5 mm  
Diam. 1.5 mm

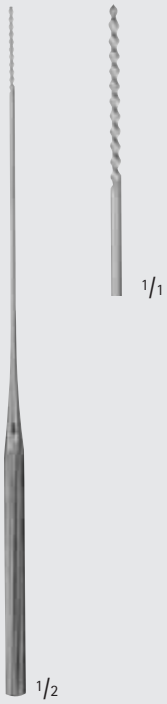

**BN452R**

spiralförmig gerieft  
rough, spiral end  
180 mm, 7"

Ø 1,8 mm  
Diam. 1.8 mm



**BN457R**

spiralförmig gerieft  
rough, spiral end  
180 mm, 7"

Ø 2,3 mm  
Diam. 2.3 mm

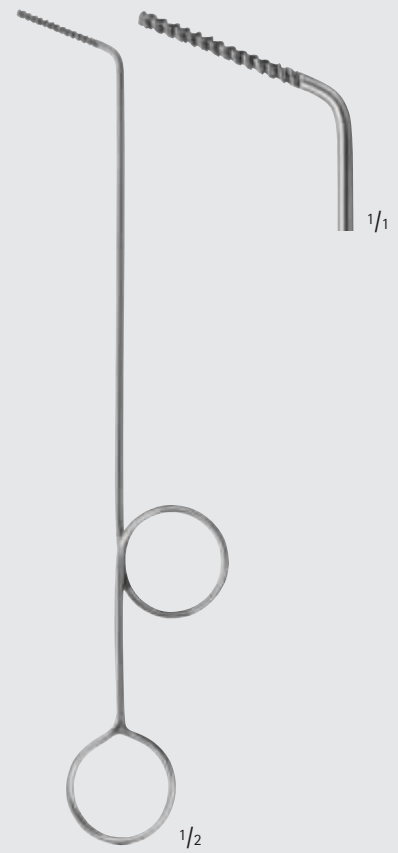

**HARTMANN**

**OM487R**

spiralförmig gerieft  
rough, spiral end  
220 mm, 8 1/2"

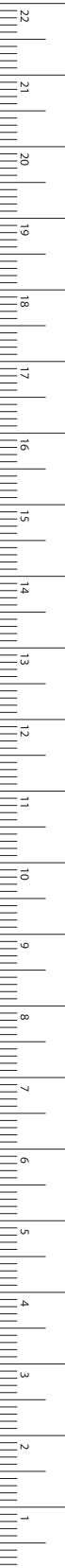

## Sonden – Probes

Wundklammern – Klammeranlegepinzetten – Klammeranlege- und Entfernungszangen  
Suture Clips – Clip Applying Forceps – Clip Applying- and Removing Forceps

BN

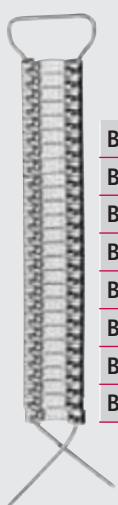

Größe mm  
Sizes mm

<b>BN507R</b>	7,5 x 1,75
<b>BN511R</b>	11,0 x 2,0
<b>BN512R</b>	12,0 x 2,5
<b>BN515R</b>	14,0 x 3,0
<b>BN516R</b>	16,0 x 3,0
<b>BN518R</b>	18,0 x 3,0
<b>BN520R</b>	20,0 x 3,0
<b>BN522R</b>	22,0 x 3,0



1/1



1/1

MICHEL

**BN507R-BN522R**

Wundklammern aus nichtrostendem Stahl  
Bestelleinheit: **PAK** = 1 Packung à 100 Stück  
Suture clips, stainless steel  
Sales unit: **PAK** = 1 Package of 100 pieces



1/2

MICHEL

**BN730R**

Klammeranlegepinzette  
Clip applying forceps  
125 mm, 5"



1/2

HEGENBARTH

**BN731R**

Klammeranlegepinzette  
Clip applying forceps  
120 mm, 4 3/4"



1/2

MICHEL

**BN750R**

Klammeranlege und  
-Abnehmzange  
Clip applying and  
removing forceps  
125 mm, 5"



1/2

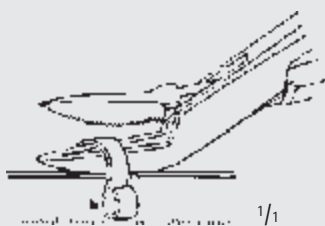

1/1

MICHEL MODIF.

**BN754R**

Klammeranlege und -Abnehmzange  
Clip applying and removing forceps  
130 mm, 5 1/8"



1/2

HEATH

**BN757R**

Klammerabnehmzange  
Clip removing forceps  
135 mm, 5 1/4"



1/2

COLLIN

**BN758R**

Klammerabnehmzange  
Clip removing forceps  
135 mm, 5 1/4"



**Sonden – Probes**  
 REDON-Führungsnadeln  
 REDON-Guide Needles

**BN**



Charr.

- 8 **BN902R**
- 10 **BN903R**
- 12 **BN904R**
- 14 **BN905R**
- 16 **BN906R**
- 18 **BN907R**

mit Gewindeanschluss  
 Messerspitze,  
 schwach gebogen  
 with thread  
 knife tip, slightly curved  
 190 mm, 7 1/2"

- BN912R**
- BN913R**
- BN914R**
- BN915R**
- BN916R**
- BN917R**

mit Gewindeanschluss  
 Messerspitze,  
 stark gebogen  
 with thread  
 knife tip, strongly curved  
 190 mm, 7 1/2"

- BN922R**
- BN923R**
- BN924R**
- BN925R**
- BN926R**

mit Gewindeanschluss  
 Lanzettenspitze,  
 schwach gebogen  
 with thread  
 lancet tip, slightly curved  
 190 mm, 7 1/2"

- BN942R**
- BN943R**
- BN944R**
- BN945R**
- BN946R**
- BN947R**

mit Gewindeanschluss  
 Dreikantspitze,  
 schwach gebogen  
 with thread  
 trocar tip, slightly curved  
 190 mm, 7 1/2"



MILLIMETERS



INCHES



BT



**Wundhaken**

Wound Retractors

# Wundhaken – Wound Retractors

Nerv- und Gefäßhäkchen

Nerve- and Vessel Hooks

BT

Maßangaben für Blattgrößen der Wundhaken

1. Zahl = Tiefe Beispiel: 25 x 38 mm

2. Zahl = Breite

Dimensions for blade size of retractors

1st number = depth Example: 25 x 38 mm

2nd number = width

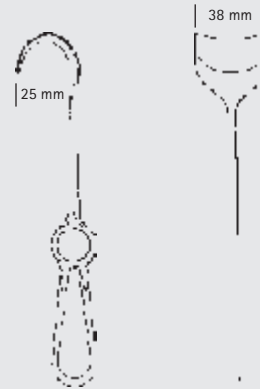

OF282R OF283R OF284R OF285R 1/1

WAGENER

OF282R-OF285R

150 mm, 6"

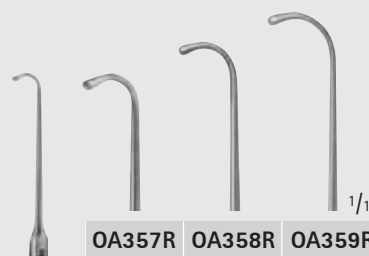

OA357R OA358R OA359R 1/1

GRAEFE

OA357R-OA359R

140 mm, 5 1/2"



1/1

ST. BARTS

OF288R

Ohrhäkchen, stumpf

Hook, blunt

180 mm, 7"





## Wundhaken – Wound Retractors

Nerv- und Gefäßhäkchen  
Nerve- and Vessel Hooks

BT



MILLIMETERS



BROM

**BT075R**

Venenhäkchen  
Vein hook  
170 mm, 6 3/4"



CRILE

**BT080R**

200 mm, 8"



CUSHING

**BT082R–BT083R**

190 mm, 7 1/2"

## Wundhaken – Wound Retractors

Nerv- und Gefäßhäkchen

Nerve- and Vessel Hooks

Maßangaben für Blattgrößen der Wundhaken

1. Zahl = Tiefe Beispiel: 25 x 38 mm

2. Zahl = Breite

Dimensions for blade size of retractors

1st number = depth Example: 25 x 38 mm

2nd number = width

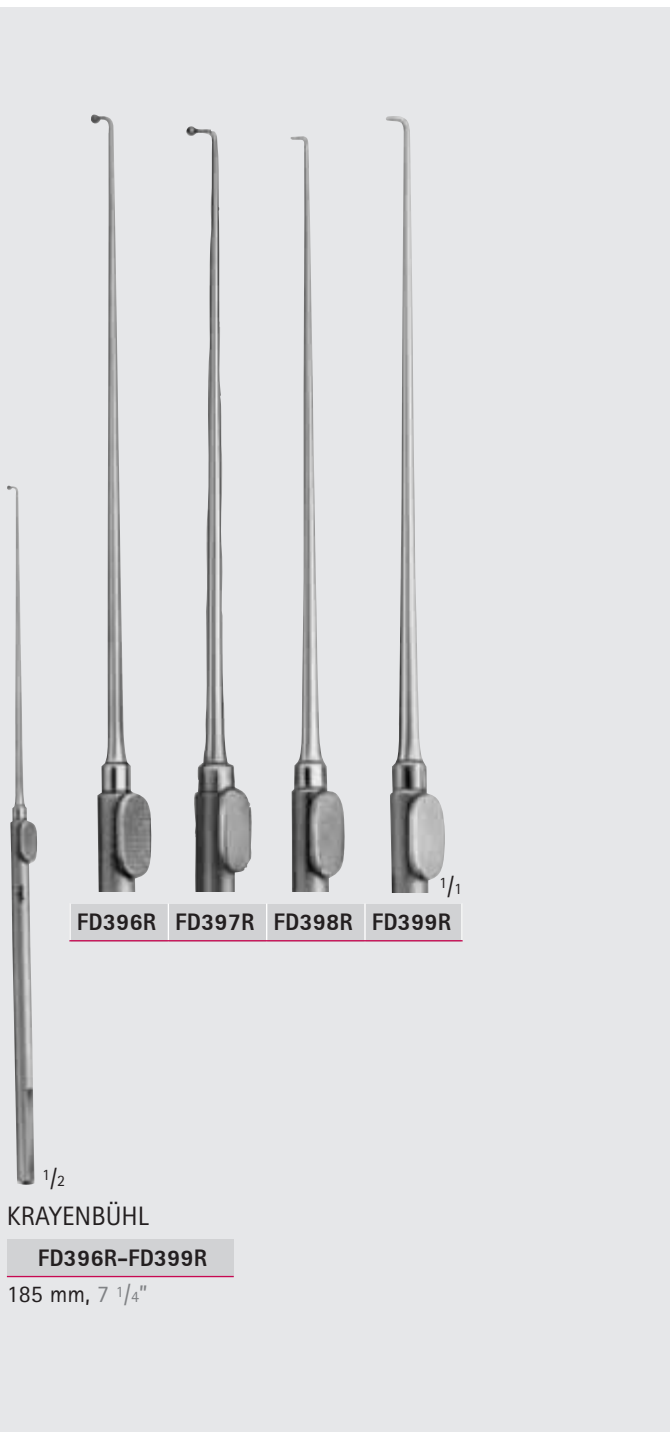
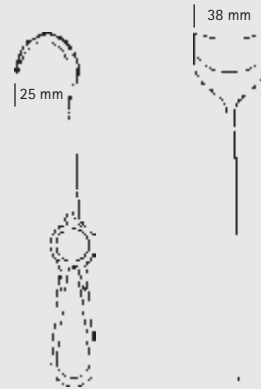



## Wundhaken – Wound Retractors

Nerv- und Gefäßhäkchen  
Nerve- and Vessel Hooks

BT

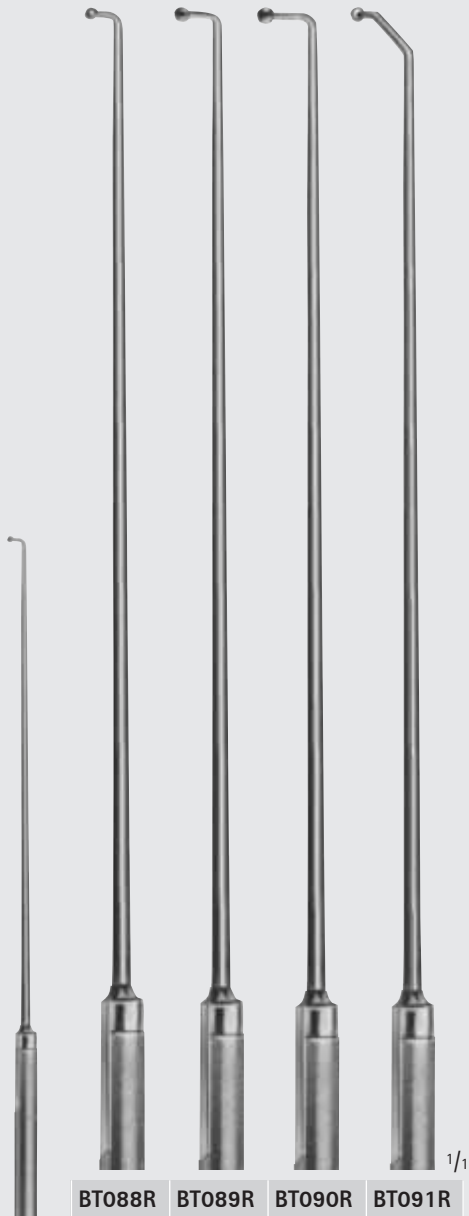

BT088R BT089R BT090R BT091R

CASPAR

**BT088R-BT091R**

Explorationshäkchen,  
geknöpft  
Exploration hooks,  
probe-ended  
245 mm, 9 3/4"



CUSHING

**BT084R**

280 mm, 11"

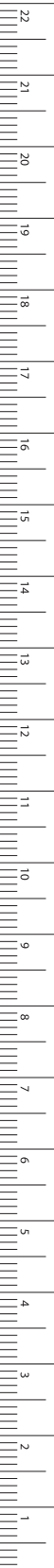

## Wundhaken – Wound Retractors

Feine Wundhäkchen (Dura- und Hauthäkchen)

Fine Wound Retractors (Dura- and Skin Retractors)

Maßangaben für Blattgrößen der Wundhaken

1. Zahl = Tiefe Beispiel: 25 x 38 mm

2. Zahl = Breite

Dimensions for blade size of retractors

1st number = depth Example: 25 x 38 mm

2nd number = width

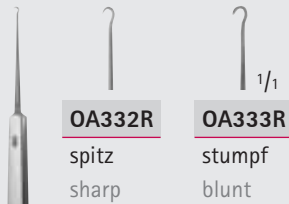
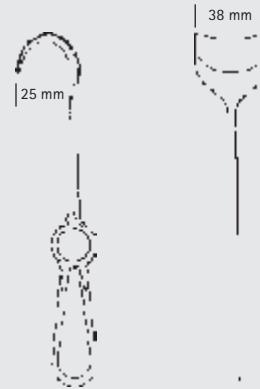

**OA332R**

spitz  
sharp

**OA333R**

stumpf  
blunt

GRAEFE

**OA332R-OA333R**

125 mm, 5"

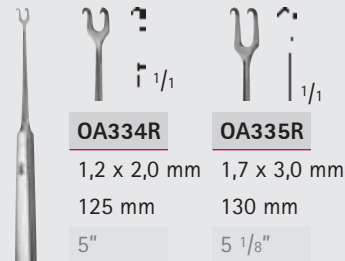

**OA334R**

1,2 x 2,0 mm

125 mm

5"

**OA335R**

1,7 x 3,0 mm

130 mm

5 1/8"

GUTHRIE

**OA334R-OA335R**

spitz  
sharp

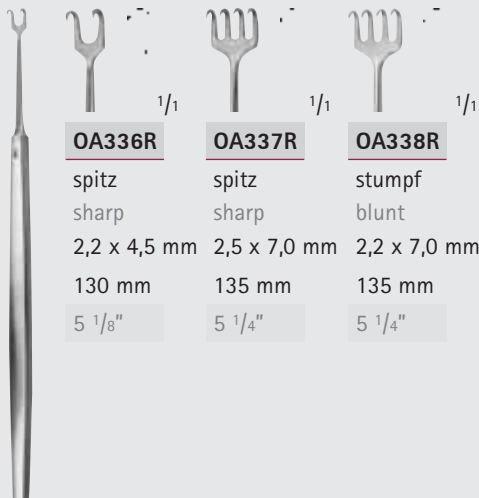

**OA336R**

spitz  
sharp

2,2 x 4,5 mm

130 mm

5 1/8"

**OA337R**

spitz  
sharp

2,5 x 7,0 mm

135 mm

5 1/4"

**OA338R**

stumpf  
blunt

2,2 x 7,0 mm

135 mm

5 1/4"

ROLLET

**OA336R-OA338R**



CAIRNS

**FF313R**

Durahäkchen  
Dura retractor  
130 mm, 5 1/8"



FRAZIER

**FF321R**

Durahäkchen  
Dura retractor  
130 mm, 5 1/8"



TÖNNIS

**FF322R**

Durahäkchen  
Dura retractor  
150 mm, 6"



## Wundhaken – Wound Retractors

Feine Wundhäkchen (Dura- und Hauthäkchen)  
Fine Wound Retractors (Dura- and Skin Retractors)

BT



1/2

KILNER

**OL610R**

160 mm, 6 1/4"



1/2

MC INDOE

**OL615R-OL616R**

150 mm, 6"

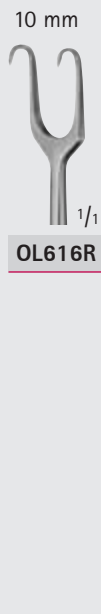

1/1

OL616R

**OL616R**

150 mm, 6"



1/2

FREER

**OL621R**

150 mm, 6"



1/2

MÜLLER

**OL626R**

150 mm, 6"



1/2

MÜLLER

**OL627R**

150 mm, 6"



1/2

COTTLE

**OL617R**

160 mm, 6 1/4"



1/2

COTTLE

**OL619R**

160 mm, 6 1/4"

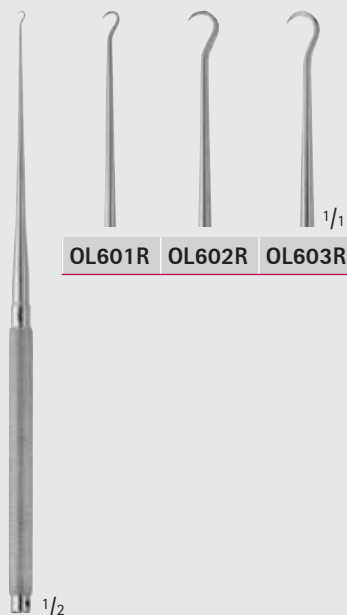

1/2

KLEINERT-KUTZ

**OL601R-OL603R**

160 mm, 6 3/8"



MILLIMETERS

## Wundhaken – Wound Retractors

Feine Wundhäkchen (Dura- und Hauthäkchen)

Fine Wound Retractors (Dura- and Skin Retractors)

Maßangaben für Blattgrößen der Wundhaken

1. Zahl = Tiefe Beispiel: 25 x 38 mm

2. Zahl = Breite

Dimensions for blade size of retractors

1st number = depth Example: 25 x 38 mm

2nd number = width

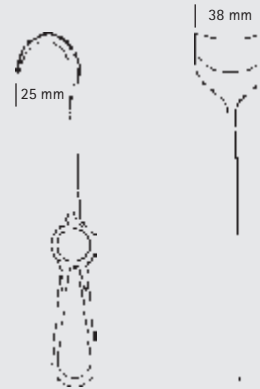

BT



JÄGER

**OA351R**

135 mm, 5 1/4"

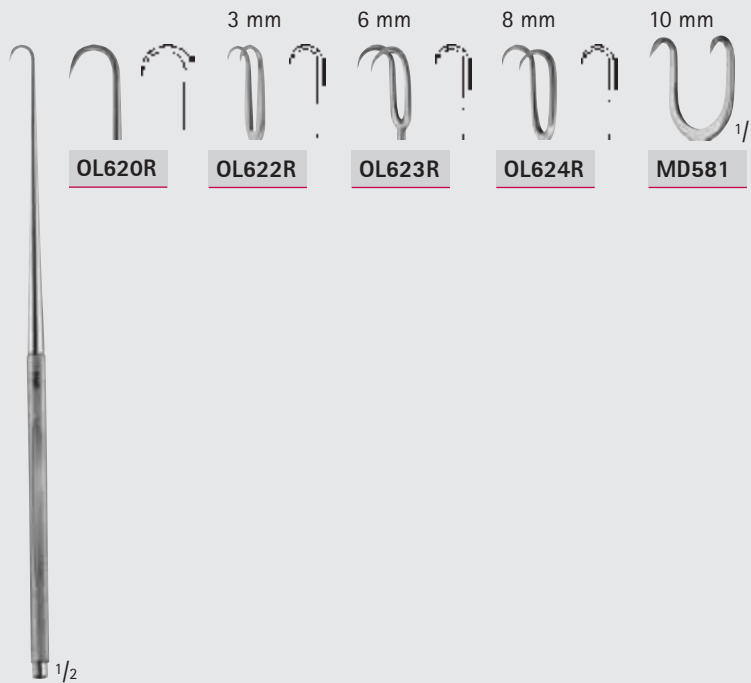

JOSEPH

**OL620R-MD581R**

165 mm, 6 1/2"



GILLIES

**OL611R-OL612R**

180 mm, 7"

## Wundhaken – Wound Retractors

Feine Wundhäkchen (Dura- und Hauthäkchen)  
Fine Wound Retractors (Dura- and Skin Retractors)

BT

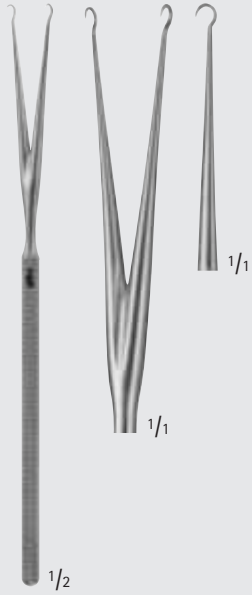

BARSKY

**OL614R**

155 mm, 6"



DURAHÄKCHEN

**FD375R**

Dura retractor  
185 mm, 7 1/4"



FISCH

**FD376R**

Dura retractor  
185 mm, 7 1/4"



KILNER

**OL206R**

spitz  
sharp  
80 mm, 3 1/4"

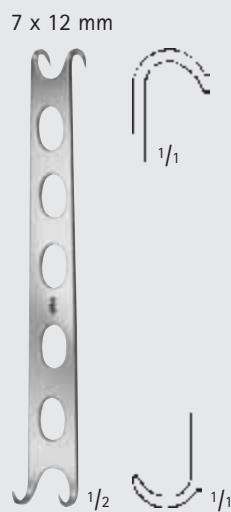

CONVERSE

**OL207R**

stumpf  
blunt  
120 mm, 4 3/4"

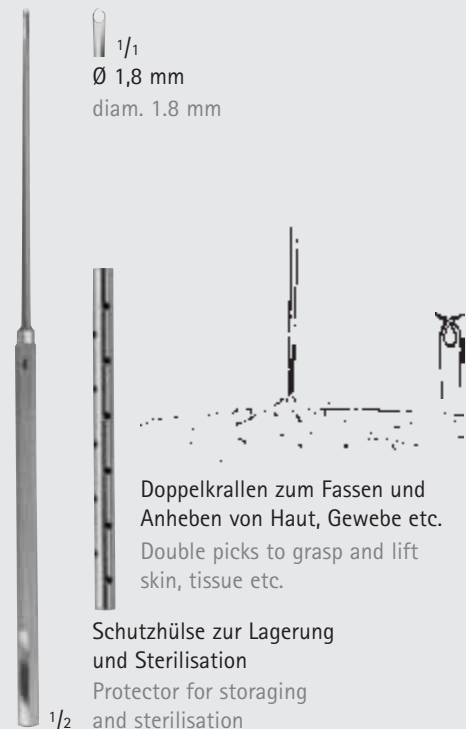

GEWEBEKRALLE

**FD392R**

Tissue pick  
185 mm, 7 1/4"

Doppelkrallen zum Fassen und Anheben von Haut, Gewebe etc.  
Double picks to grasp and lift skin, tissue etc.

Schutzhülse zur Lagerung und Sterilisation  
Protector for storing and sterilisation



MILLIMETERS

# Wundhaken – Wound Retractors

Wund- und Trachealhäkchen

Wound- and Trachea Retractors

BT

Maßangaben für Blattgrößen der Wundhaken

1. Zahl = Tiefe Beispiel: 25 x 38 mm

2. Zahl = Breite

Dimensions for blade size of retractors

1st number = depth Example: 25 x 38 mm

2nd number = width

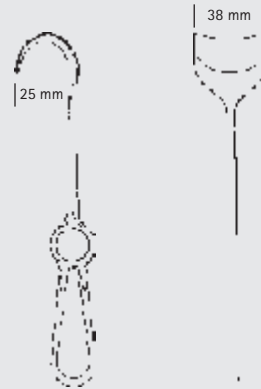

BERGMANN

**BT100R**

140 mm, 5 1/2"



BOSE

**FA025R**

165 mm, 6 1/2"



BOSE

**FA026R**

165 mm, 6 1/2"

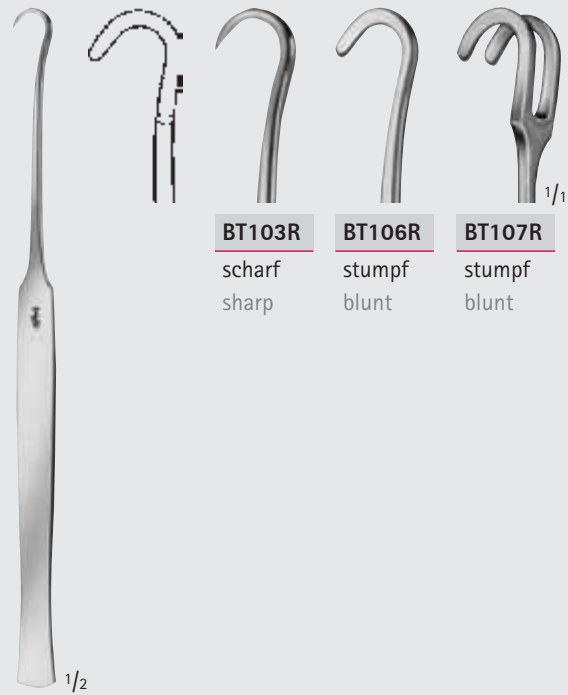

**BT103R**

scharf  
sharp

**BT106R**

stumpf  
blunt

**BT107R**

stumpf  
blunt

**BT103R-BT107R**

180 mm, 7"





## Wundhaken – Wound Retractors

Wund- und Trachealhäkchen  
Wound- and Trachea Retractors

BT



MILLIMETERS



**BT132R**

3,5 x 4,5 mm

**BT133R**

4,0 x 7,2 mm

**BT134R**

4,0 x 10,0 mm

<sup>1</sup>/<sub>2</sub>

**BT132R-BT134R**

flexibler Schaft, scharf  
flexible shaft, sharp  
155 mm, 6"



**BT136R**

4,0 x 4,5 mm

**BT137R**

4,0 x 7,5 mm

**BT138R**

4,0 x 10,2 mm

<sup>1</sup>/<sub>2</sub>

**BT136R-BT138R**

flexibler Schaft, stumpf  
flexible shaft, blunt  
155 mm, 6"



**BT111R**

**BT112R**

5,0 x 4,2 mm

**BT113R**

5,0 x 7,0 mm

**BT114R**

5,0 x 9,5 mm

<sup>1</sup>/<sub>2</sub>

**BT111R-BT114R**

enge Biegung, scharf  
small curve, sharp  
165 mm, 6 1/2"

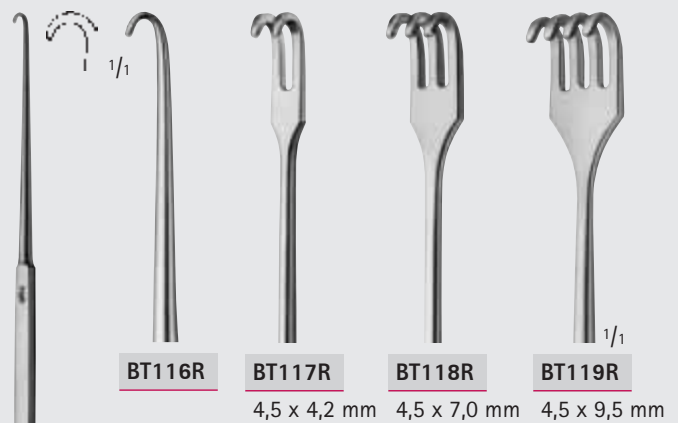

**BT116R**

**BT117R**

4,5 x 4,2 mm

**BT118R**

4,5 x 7,0 mm

**BT119R**

4,5 x 9,5 mm

<sup>1</sup>/<sub>2</sub>

**BT116R-BT119R**

enge Biegung, stumpf  
small curve, blunt  
165 mm, 6 1/2"

## Wundhaken – Wound Retractors

Wund- und Trachealhäkchen

Wound- and Trachea Retractors

Maßangaben für Blattgrößen der Wundhaken

1. Zahl = Tiefe Beispiel: 25 x 38 mm

2. Zahl = Breite

Dimensions for blade size of retractors

1st number = depth Example: 25 x 38 mm

2nd number = width

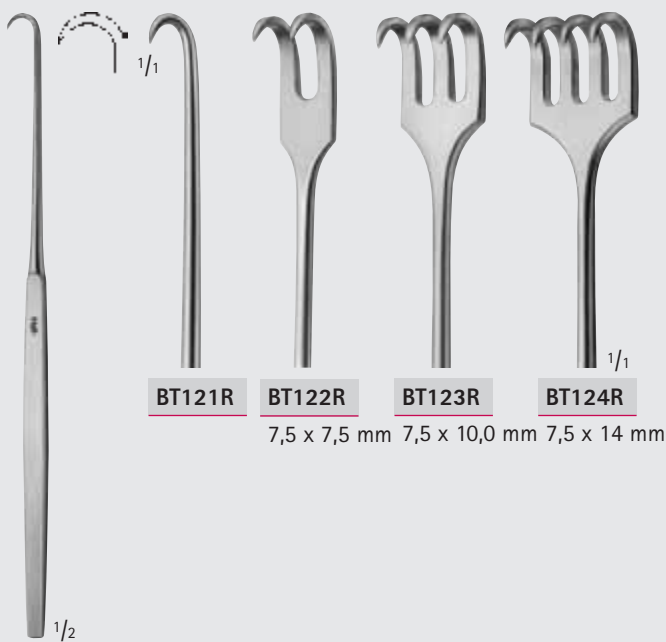
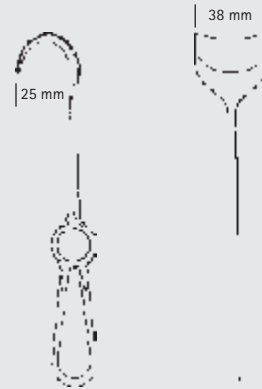

**BT121R**

**BT122R**

**BT123R**

**BT124R**

7,5 x 7,5 mm 7,5 x 10,0 mm 7,5 x 14 mm

**BT121R–BT124R**

weite Biegung, scharf  
large curve, sharp

165 mm, 6 1/2"

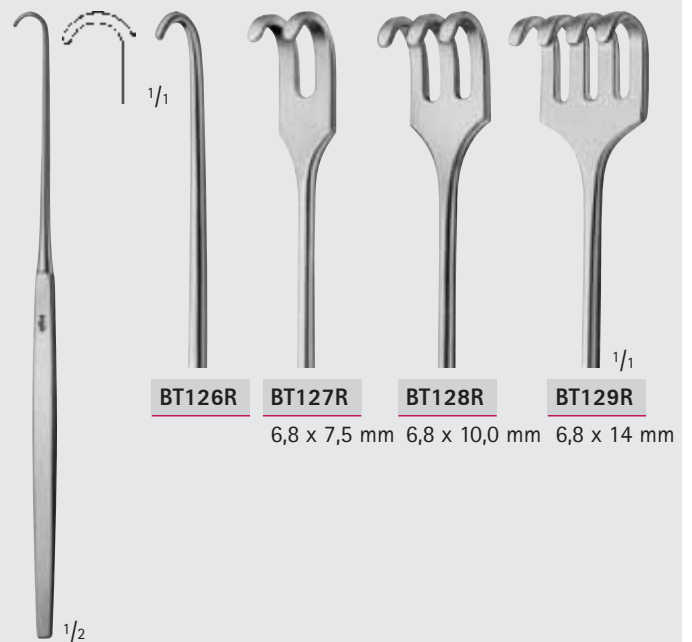

**BT126R**

**BT127R**

**BT128R**

**BT129R**

6,8 x 7,5 mm 6,8 x 10,0 mm 6,8 x 14 mm

**BT126R–BT129R**

weite Biegung, stumpf  
large curve, blunt

165 mm, 6 1/2"



## Wundhaken – Wound Retractors

Wundhaken mit Treangle-Griff  
Retractors with Treangle Handle

**BT**

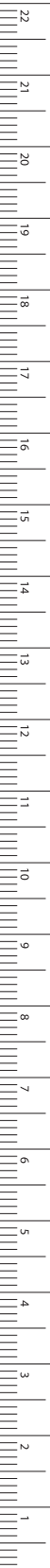

MILLIMETERS

**BT901R**  
scharf  
sharp  
135 mm, 5 1/4"

**BT902R**  
scharf  
sharp  
155 mm, 6"

**BT904R**  
scharf  
sharp  
155 mm, 6"

**BT906R**  
8,0 x 12,5 mm

**BT908R**  
10,2 x 21,5 mm

**BT906R-BT908R**  
Gabelhaken, retrograd gebogen  
Forked hooks, retrograd curved  
155 mm, 6"

**BT911R**

**BT912R**  
5,0 x 4,0 mm

**BT913R**  
5,5 x 7,2 mm

**BT911R-BT913R**  
enge Biegung, scharf  
small curve, sharp  
155 mm, 6"

**BT916R**

**BT917R**  
5,5 x 4,0 mm

**BT918R**  
5,5 x 7,2 mm

**BT916R-BT918R**  
enge Biegung, stumpf  
small curve, blunt  
155 mm, 6"

**BT921R**

**BT922R**  
8,0 x 8,0 mm

**BT923R**  
7,0 x 11,0 mm

**BT921R-BT923R**  
weite Biegung, scharf  
large curve, sharp  
155 mm, 6"

**BT926R**

**BT927R**  
7,0 x 8,0 mm

**BT928R**  
7,0 x 11,0 mm

**BT926R-BT928R**  
weite Biegung, stumpf  
large curve, blunt  
155 mm, 6"

## Wundhaken – Wound Retractors

Wundhaken mit Treangle Griff

Retractors with Treangle Handle

Maßangaben für Blattgrößen der Wundhaken

1. Zahl = Tiefe Beispiel: 25 x 38 mm

2. Zahl = Breite

Dimensions for blade size of retractors

1st number = depth Example: 25 x 38 mm

2nd number = width

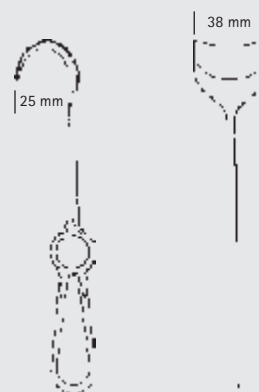

MANNERFELT MODIF.

**BT933R**

flexibler Schaft,  
enge Biegung, scharf  
flexible shaft,  
small curve, sharp  
155 mm, 6"

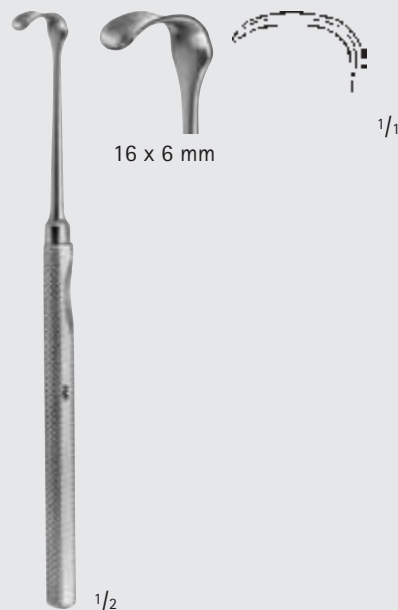

MANNERFELT MODIF.

**BT940R**

hohlgekehlt  
hollow grooved  
155 mm, 6"



LANGENBECK-MANNERFELT MODIF.

**BT943R-BT946R**

155 mm, 6"



## Wundhaken – Wound Retractors

Wundhaken mit Treangle-Griff  
Retractors with Treangle Handle

BT

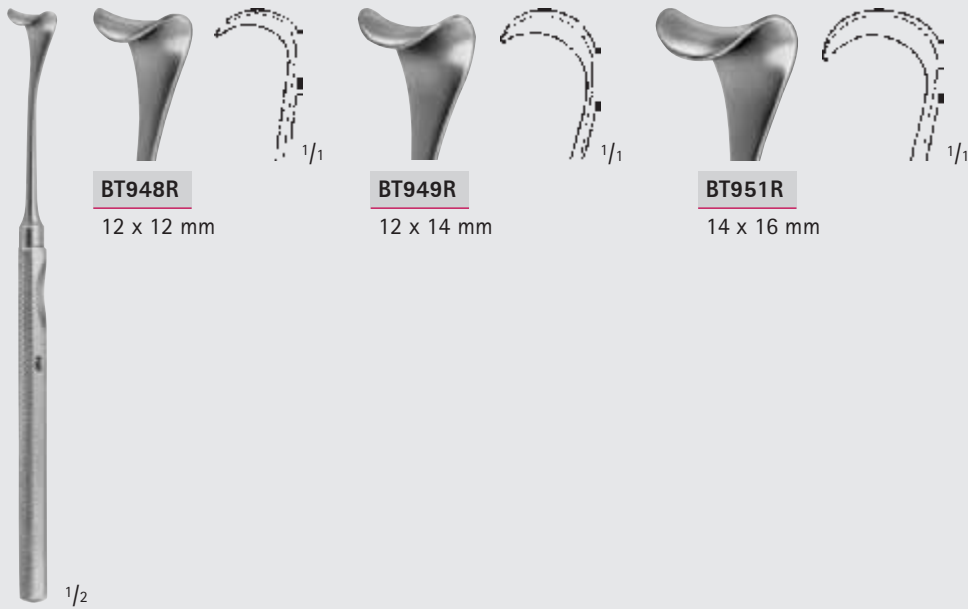

**BT948R**

12 x 12 mm

**BT949R**

12 x 14 mm

**BT951R**

14 x 16 mm

MANNERFELT MODIF.

**BT948R-BT951R**

Sattelhaken  
Saddle hooks  
155 mm, 6"



12 x 12 mm

MANNERFELT MODIF.

**BT958R**

Sattelhaken, gefenstert  
Saddle hook, fenestrated  
155 mm, 6"



MANNERFELT MODIF.

**BT964R**

Sehnen-Doppelhaken  
Tendon double hook  
160 mm, 6 1/4"



MANNERFELT MODIF.

**BT966R**

Doppelspatel  
Spatula, double-ended  
160 mm, 6 1/4"

MILLIMETERS

# Wundhaken – Wound Retractors

Wundhaken

Retractors

Maßangaben für Blattgrößen der Wundhaken

1. Zahl = Tiefe Beispiel: 25 x 38 mm

2. Zahl = Breite

Dimensions for blade size of retractors

1st number = depth Example: 25 x 38 mm

2nd number = width

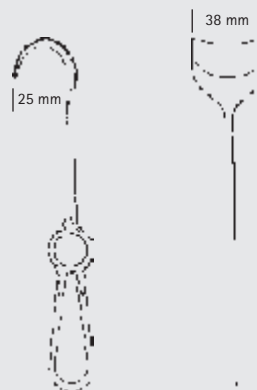

BT



FOMON

**OL202R**

145 mm, 5 3/4"

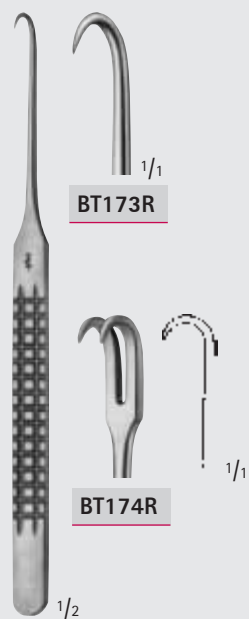

**BT173R**

**BT174R**

**BT173R-BT174R**

160 mm, 6 1/4"



**BT177R**

**BT178R**

LANGENBECK-GREEN

**BT177R-BT178R**

160 mm, 6 1/4"

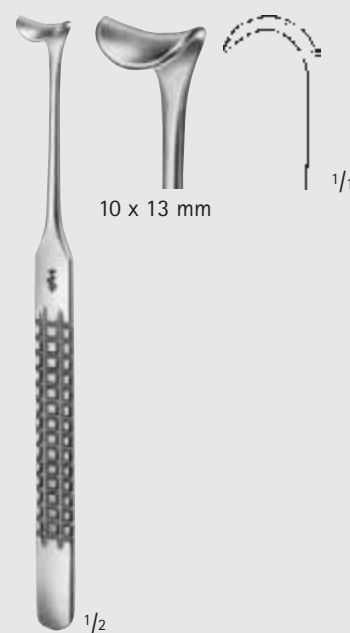

10 x 13 mm

**BT179R**

160 mm, 6 1/4"



# Wundhaken – Wound Retractors

Wundhaken  
Retractors

BT

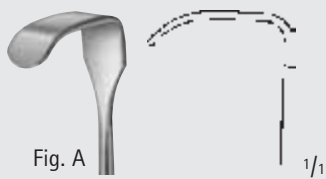
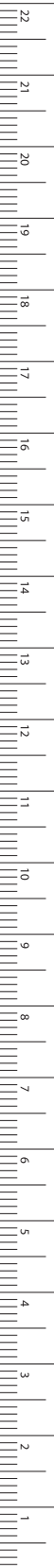

Fig. A

**BT193R**

18 x 7 mm



Fig. B

**BT194R**

16 x 5 mm

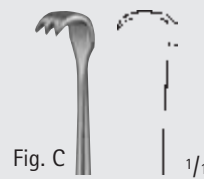

Fig. C

**BT195R**

7 x 4 mm



Fig. D

**BT196R**

5 x 10 mm



Fig. E

**BT197R**

11 x 4 mm

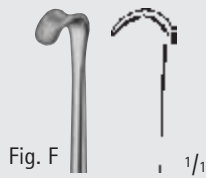

Fig. F

**BT198R**

6 x 4 mm



1/2

MEYERDING

**BT193R-BT198R**

Fig. A - Fig. F  
180 mm, 7"

## Wundhaken – Wound Retractors

Wundhaken

Retractors

Maßangaben für Blattgrößen der Wundhaken

1. Zahl = Tiefe Beispiel: 25 x 38 mm

2. Zahl = Breite

Dimensions for blade size of retractors

1st number = depth Example: 25 x 38 mm

2nd number = width

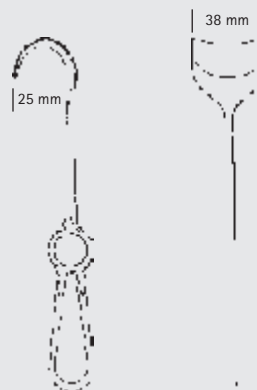

EMMET

**BT161R**

Fistelhaken

Fistula hook

220 mm, 8 3/4"



SIMON

**BT166R**

Fistelhaken

Fistula hook



SIMON

**BT167R**

Fistelhaken

Fistula hook

220 mm, 8 3/4"



LANGE

**OL201R**

Fistelhaken

Fistula hook

235 mm, 9"





## Wundhaken – Wound Retractors

Wundhaken  
Wound Retractors

BT



MILLIMETERS

11 x 8 mm

**PAUL**

**OA340R**

Sehnenscheidenhaken  
Tendon hook  
120 mm, 4 3/4"

**BT170R**  
12 x 6 mm

**BT171R**  
12 x 11 mm

**BT170R-BT171R**

Sehnenscheidenhaken  
Tendon hooks  
175 mm, 7"

15 x 11 mm

**KLAPP**

**BT172R**

Sehnenscheidenhaken  
Tendon hook  
175 mm, 7"

**BT180R**  
15 x 6 mm  
stumpf  
blunt

**BT181R**  
15 x 6 mm  
gezahnt  
toothed

**STRANDELL-STILLE**

**BT180R-BT181R**

Sehnenscheidenhaken  
Tendon hooks  
180 mm, 7"

6 x 12 mm

**MASING**

**OL211R**

140 mm, 5 1/2"

10 x 12 mm

**COTTLE**

**OL212R**

140 mm, 5 1/2"

**OA310R** 9 x 9 mm

**OA311R** 9 x 12 mm

**OA312R** 11 x 14 mm

**OA313R** 12 x 16 mm

**OA314R** 13 x 18 mm

**DESMARRES**

**OA310R-OA314R**

140 mm, 5 1/2"

## Wundhaken – Wound Retractors

Wund- und Venenhaken

Wound- and Vein Retractors

Maßangaben für Blattgrößen der Wundhaken

1. Zahl = Tiefe Beispiel: 25 x 38 mm

2. Zahl = Breite

Dimensions for blade size of retractors

1st number = depth Example: 25 x 38 mm

2nd number = width

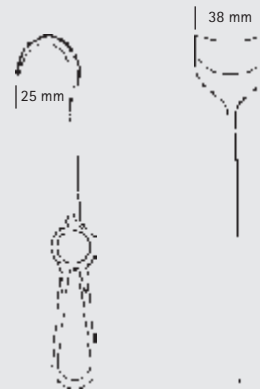

KÖNIG

**BT182R-BT183R**

180 mm, 7"



CUSHING-KOCHER

**BT190R**

175 mm, 7"



KOCHER

**BT457R-BT458R**

205 mm, 8"



## Wundhaken – Wound Retractors

Wund- und Venenhaken  
Wound- and Vein Retractors

BT



MILLIMETERS



$\frac{1}{1}$   
13 x 6 mm

$\frac{1}{2}$   
SCHOENBORN

**BT192R**

200 mm, 8"

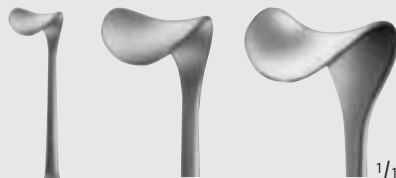

**BT184R**

10 x 13 mm

$\frac{1}{1}$   
**BT185R**

14 x 18 mm

$\frac{1}{2}$   
CUSHING

**BT184R-BT185R**

205 mm, 8"

20 x 15 mm

20 x 19 mm  
 $\frac{1}{2}$

**BT187R**

205 mm, 8"

## Wundhaken – Wound Retractors

Wund- und Venenhaken

Wound- and Vein Retractors

Maßangaben für Blattgrößen der Wundhaken

1. Zahl = Tiefe Beispiel: 25 x 38 mm

2. Zahl = Breite

Dimensions for blade size of retractors

1st number = depth Example: 25 x 38 mm

2nd number = width

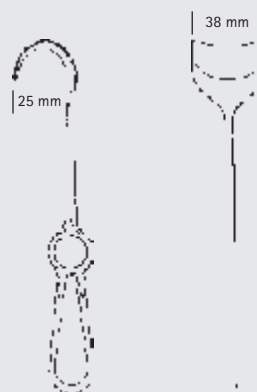

CUSHING

**BT200R–BT202R**

250 mm, 10"



**BT206R**

Präparationshäkchen  
Small dissecting hook  
235 mm, 9 1/4"

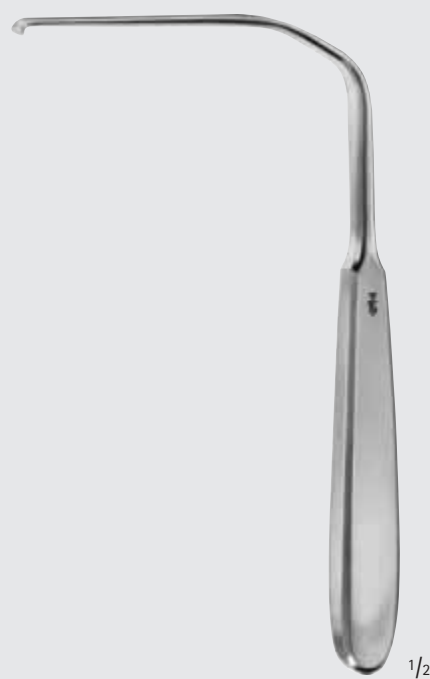

HESS

**FF707R–FF709R**

Nervwurzelhaken  
Nerve root retractors  
175 mm, 7"

BT





**Wundhaken – Wound Retractors**  
Wundhaken  
Retractors

**BT**

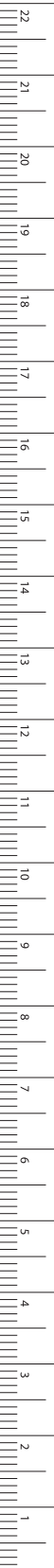

MILLIMETERS

5 x 10 mm

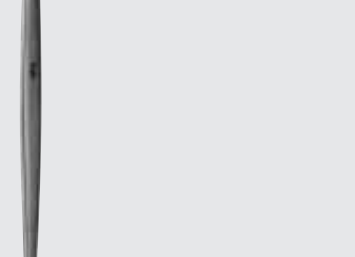

13 x 5 mm

KILNER

**BT005R**

155 mm, 6"



**BT006R**

8 x 7 mm



**BT007R**

8 x 7 mm

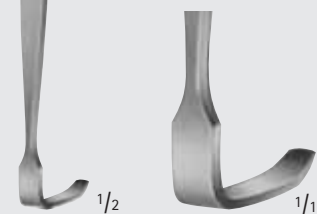

22 x 7 mm

BABY-SENN-MILLER

**BT006R-BT007R**

155 mm, 6"

8 x 7 mm



18 x 5,5 mm

SENN-MILLER

**BT008R**

165 mm, 6 1/2"

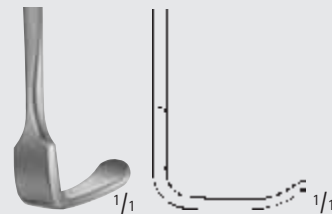

## Wundhaken – Wound Retractors

Wundhaken

Retractors

Maßangaben für Blattgrößen der Wundhaken

1. Zahl = Tiefe Beispiel: 25 x 38 mm

2. Zahl = Breite

Dimensions for blade size of retractors

1st number = depth Example: 25 x 38 mm

2nd number = width

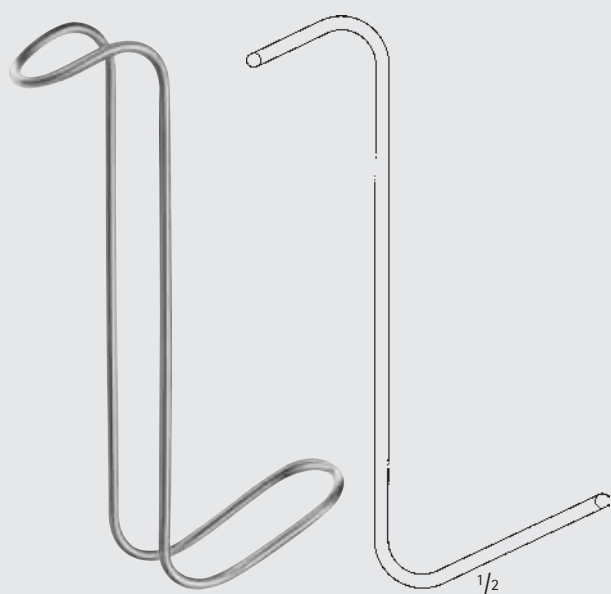
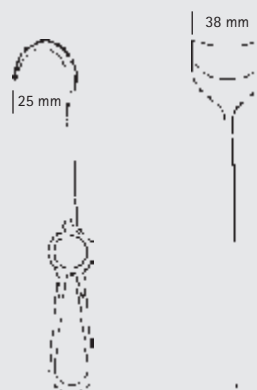

COLLIN-HARTMANN

**BT001R**

150 mm, 6"



STERNBERG

OM251R	OM252R	OM253R
120 mm	130 mm	135 mm
4 1/4"	5"	5 1/4"

BT





# Wundhaken – Wound Retractors

Wundhaken  
Retractors

**BT**

10 x 8 mm

12 x 11 mm

**LUER**

**BT010R**

110 mm, 4 3/8"

10 x 12 mm

11 x 15 mm

**ROSE**

**BT011R**

130 mm, 5 1/8"

17 x 16 mm

18 x 22 mm

**BABY-ROUX**

**BT019R**

135 mm, 5 1/4"

22 x 15 mm  
18 x 15 mm

18 x 15 mm  
22 x 15 mm

**PARKER**

**BT025R**

135 mm, 5 1/4"

5 x 3 mm

14 x 6,3 mm

**RAGNELL**

**BT004R**

150 mm, 6"

11 x 4 mm

19 x 6 mm

**CRILE**

**BT012R**

110 mm, 4 3/8"

25 x 10 mm  
22 x 10 mm

28 x 12 mm  
32 x 12 mm

**FARABEUW**

**BT020R**

125 mm, 5"

23 x 16 mm  
20 x 16 mm

24 x 16 mm  
28 x 16 mm

**FARABEUW**

**BT021R**

150 mm, 6"

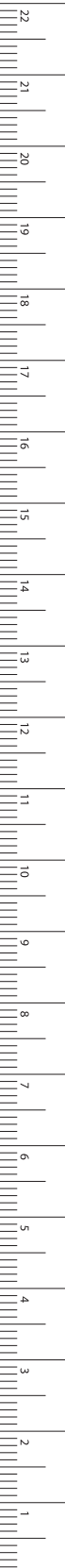

# Wundhaken – Wound Retractors

Wundhaken  
Retractors

Maßangaben für Blattgrößen der Wundhaken

1. Zahl = Tiefe                      Beispiel: 25 x 38 mm

2. Zahl = Breite

Dimensions for blade size of retractors

1st number = depth                Example: 25 x 38 mm

2nd number = width

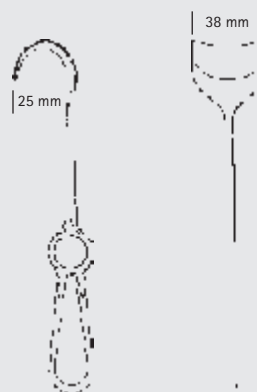

36 x 44 mm  
30 x 24 mm



36 x 44 mm  
30 x 24 mm

PARKER

**BT026R**

180 mm, 7"

21 x 14 mm  
17 x 14 mm



28 x 16 mm  
32 x 16 mm

COLLIN

**BT022R**

150 mm, 6"

BT







# Wundhaken – Wound Retractors

Wundhaken  
Retractors

BT



MILLIMETERS



ROUX

**BT030R-BT033R**

Satz komplett  
bestehend aus:

Set complete,  
consisting of:

**BT031R**

**BT032R**

**BT033R**

165 mm, 6 1/2"

19 x 22 mm



23 x 30 mm

**BT031R**

25 x 26 mm

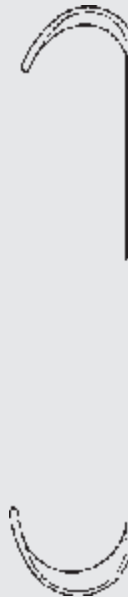

28 x 38 mm

**BT032R**

28 x 29 mm

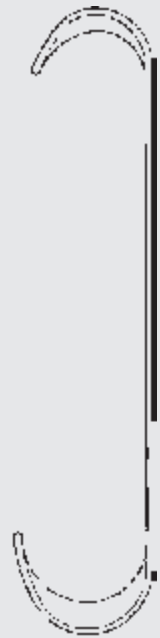

33 x 45 mm

**BT033R**

# Wundhaken – Wound Retractors

Wundhaken  
Retractors

Maßangaben für Blattgrößen der Wundhaken

1. Zahl = Tiefe                      Beispiel: 25 x 38 mm

2. Zahl = Breite

Dimensions for blade size of retractors

1st number = depth                  Example: 25 x 38 mm

2nd number = width

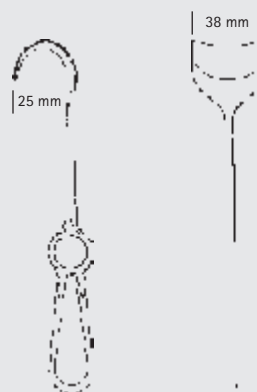

28 x 24 mm



43 x 24 mm

ROUX

**BT028R**

170 mm, 6 3/4"

28 x 28 mm



46 x 28 mm

ROUX

**BT029R**

190 mm, 7 1/2"

BT





**Wundhaken – Wound Retractors**  
Wundhaken  
Retractors

**BT**

30 x 19 mm

33 x 25 mm

**KILNER**

**OL219R**

150 mm, 6"

35 x 29 mm

40 x 35 mm

**KILNER**

**OL220R**

150 mm, 6"

20 x 22 mm

25 x 29 mm

**ROUX**

**BT034R**

150 mm, 6"

25 x 26 mm

30 x 38 mm

**ROUX**

**BT035R**

160 mm, 6 1/4"

28 x 29 mm

33 x 44 mm

**ROUX**

**BT036R**

170 mm, 6 3/4"

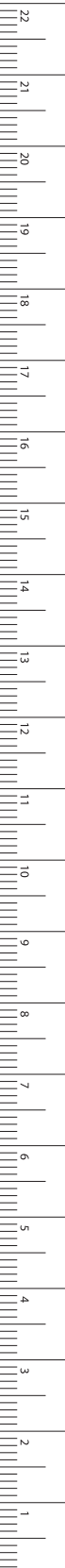

# Wundhaken – Wound Retractors

Wundhaken  
Retractors

Maßangaben für Blattgrößen der Wundhaken

1. Zahl = Tiefe Beispiel: 25 x 38 mm

2. Zahl = Breite

Dimensions for blade size of retractors

1st number = depth Example: 25 x 38 mm

2nd number = width

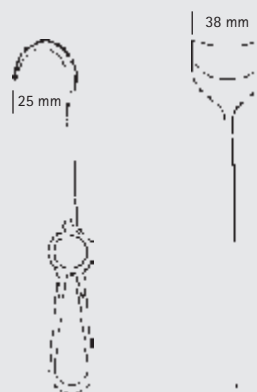

30 x 13 mm

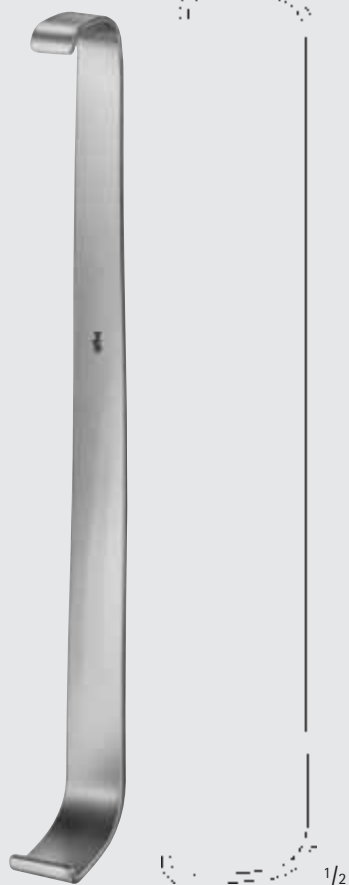

35 x 19 mm

LANE

**BT037R**

230 mm, 9"

30 x 25 mm

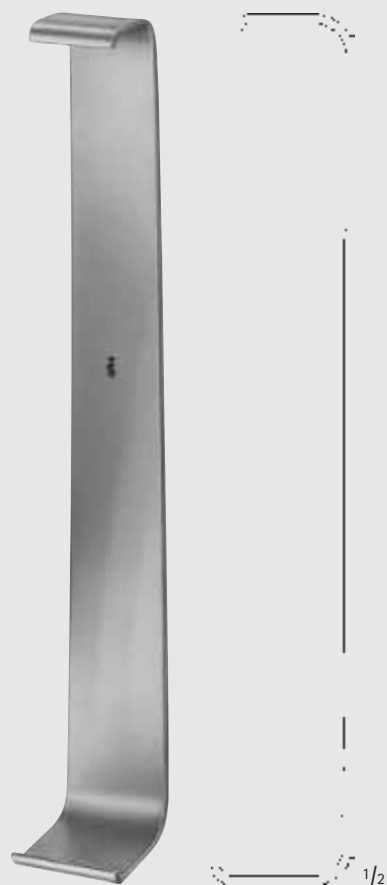

35 x 32 mm

LANE

**BT038R**

230 mm, 9"

38 x 22 mm

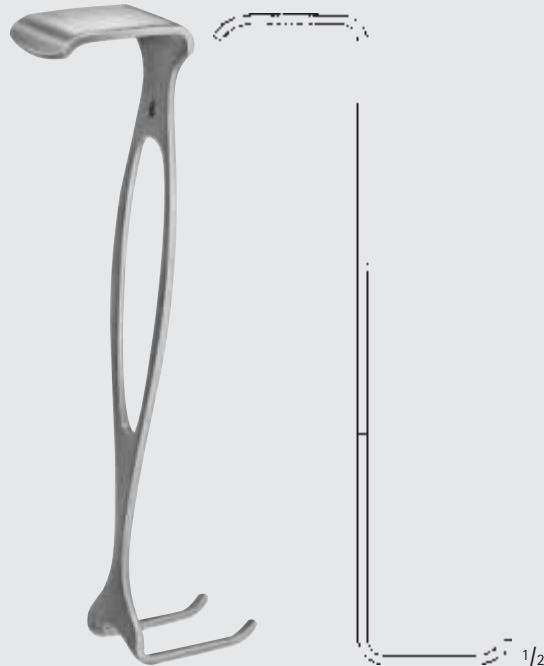

38 x 22 mm

CZERNY

**BT042R**

175 mm, 7"

BT





**Wundhaken – Wound Retractors**  
Wundhaken  
Retractors

**BT**

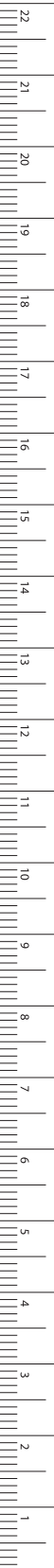

MILLIMETERS

30 x 18 mm

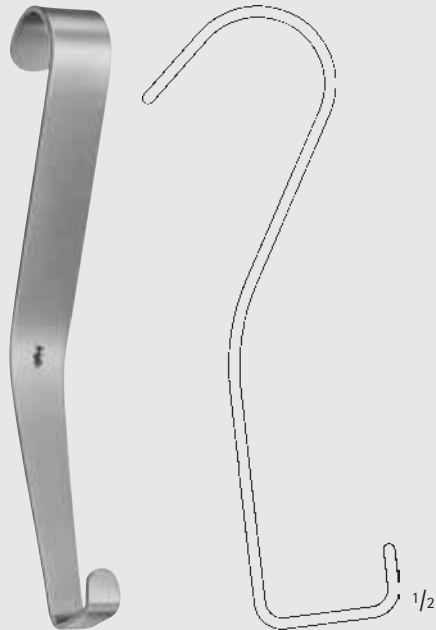

25 x 10 mm

**HAJEK**

**OL221R**

165 mm, 6 1/2"

47 x 13 mm  
41 x 13 mm



37 x 25 mm  
45 x 25 mm

**MATHIEU**

**BT040R**

200 mm, 8"

38 x 22 mm

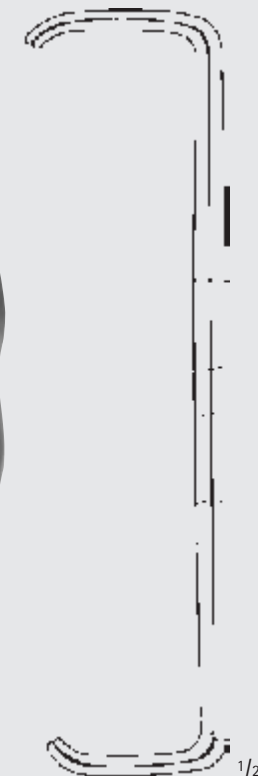

38 x 22 mm

# Wundhaken – Wound Retractors

Wundhaken  
Retractors

Maßangaben für Blattgrößen der Wundhaken

1. Zahl = Tiefe Beispiel: 25 x 38 mm

2. Zahl = Breite

Dimensions for blade size of retractors

1st number = depth Example: 25 x 38 mm

2nd number = width

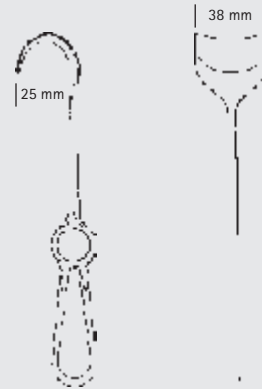

26 x 15 mm  
22 x 15 mm

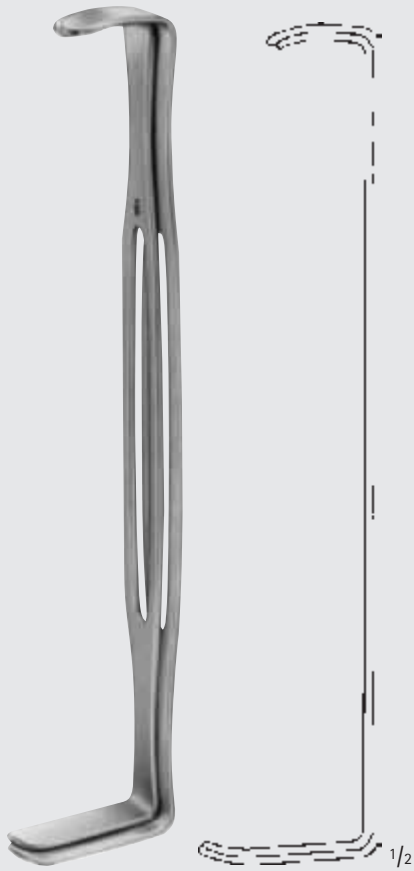

39 x 15 mm  
43 x 15 mm

US-ARMY

**BT041R**

220 mm, 8 3/4"



GOELET

**MD497**

190 mm, 7 1/2"



CANNY-RYALL

Blattbreite  
Blade width

**BT047R** 190 mm, 7 1/2" 16 mm

**BT048R** 190 mm, 7 1/2" 20 mm

**BT049R** 200 mm, 8" 25 mm

BT





**Wundhaken – Wound Retractors**  
Knochen- und Wundhaken  
Bone Retractors and Retractors

**BT**



1/1



1/2

**KOCHER**

**BT234R**

scharf  
sharp  
205 mm, 8"



1/1



1/2

**KOCHER**

**BT238R**

scharf  
sharp  
220 mm, 8 3/4"



1/1



1/2

**KOCHER**

**BT239R**

stumpf  
blunt  
220 mm, 8 3/4"



1/1



1/2

**VOLKMANN**

**BT240R**

scharf  
sharp  
220 mm, 8 3/4"



1/1



1/2

**VOLKMANN**

**BT241R**

stumpf  
blunt  
220 mm, 8 3/4"



1/1



1/2

**BT232R**

scharf  
sharp  
245 mm, 9 3/4"

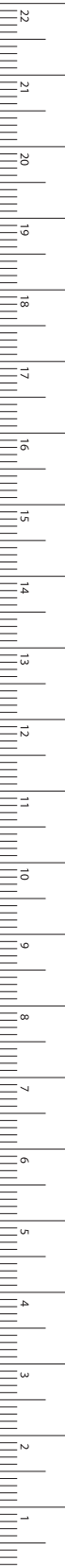

MILLIMETERS

# Wundhaken – Wound Retractors

Knochen- und Wundhaken

Bone Retractors and Retractors

Maßangaben für Blattgrößen der Wundhaken

1. Zahl = Tiefe Beispiel: 25 x 38 mm

2. Zahl = Breite

Dimensions for blade size of retractors

1st number = depth Example: 25 x 38 mm

2nd number = width

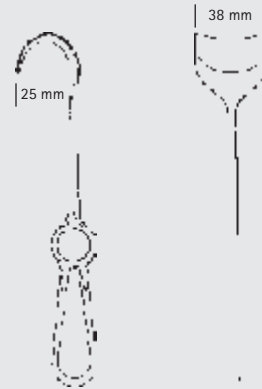

VOLKMANN

**BT221R**

scharf

sharp

220 mm, 8 3/4"

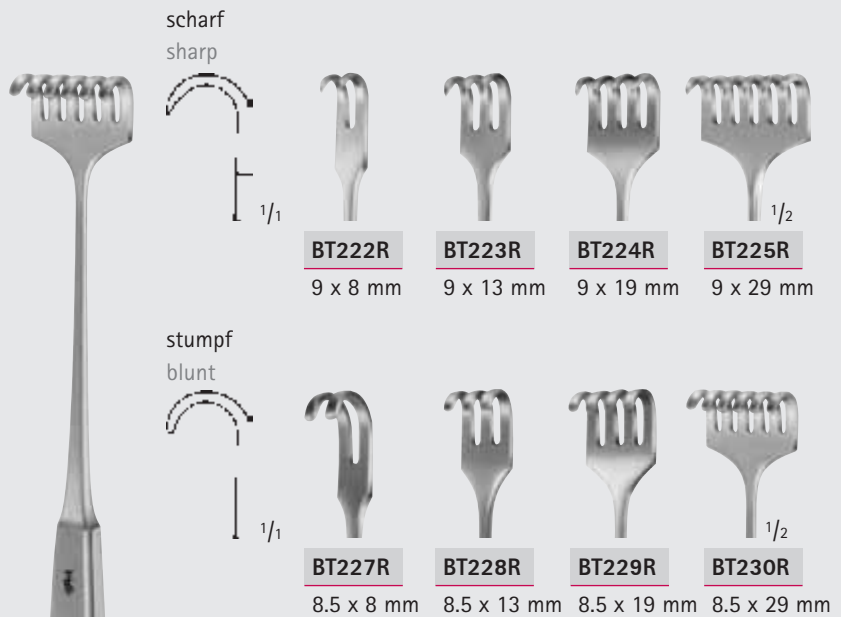

VOLKMANN

**BT222R-BT230R**

225 mm, 9"

BT





# Wundhaken – Wound Retractors

Wundhaken  
Retractors

**BT**



scharf  
sharp

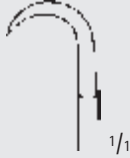

**BT242R**  
9 x 8 mm



**BT243R**  
9 x 13 mm



**BT244R**  
9 x 19 mm



**BT246R**  
9 x 29 mm



**BT248R**  
9 x 40 mm

stumpf  
blunt

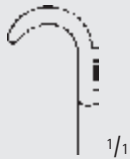

**BT252R**  
8 x 8 mm



**BT253R**  
8 x 13 mm



**BT254R**  
8 x 19 mm



**BT256R**  
8 x 29 mm



**BT258R**  
8 x 40 mm

halbscharf  
semi-sharp



**BT257R**  
8.5 x 8 mm



**BT259R**  
8.5 x 13 mm



**BT260R**  
8.5 x 19 mm



**BT261R**  
8.5 x 29 mm



**BT265R**  
8,5 x 40 mm



VOLKMANN

**BT242R-BT265R**

220 mm, 8 3/4"

MILLIMETERS

# Wundhaken – Wound Retractors

Wundhaken

Retractors

Maßangaben für Blattgrößen der Wundhaken

1. Zahl = Tiefe                      Beispiel: 25 x 38 mm

2. Zahl = Breite

Dimensions for blade size of retractors

1st number = depth                  Example: 25 x 38 mm

2nd number = width

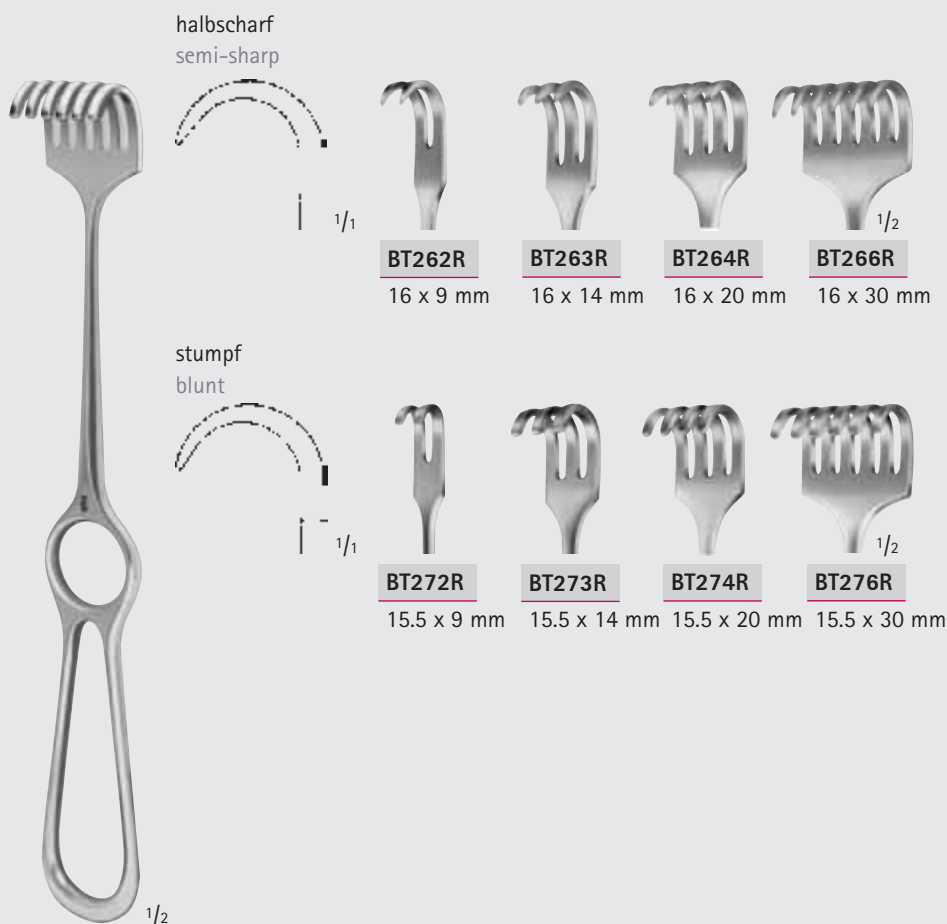
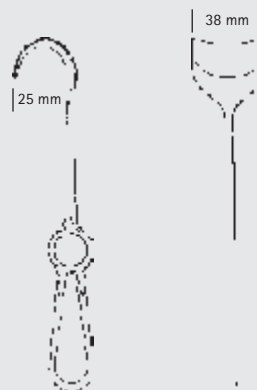

KOCHER

**BT262R-BT276R**

220 mm, 8 3/4"

BT





## Wundhaken – Wound Retractors

Wundhaken  
Retractors

BT



MILLIMETERS

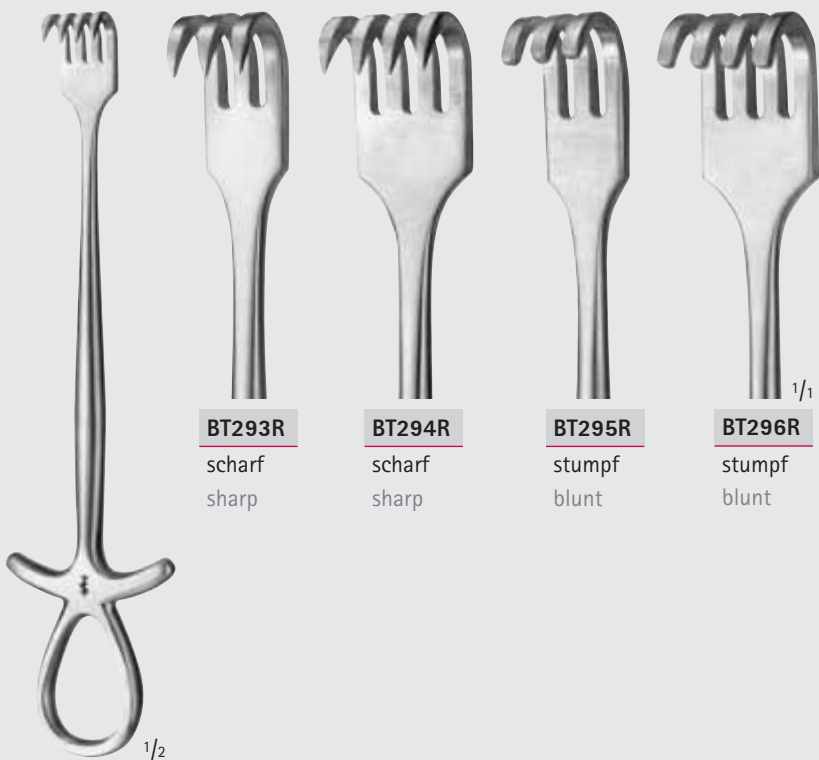

**BT293R**

scharf  
sharp

**BT294R**

scharf  
sharp

**BT295R**

stumpf  
blunt

**BT296R**

stumpf  
blunt

<sup>1</sup>/<sub>2</sub>

<sup>1</sup>/<sub>1</sub>

MURPHY

**BT293R–BT296R**

195 mm, 7 <sup>3</sup>/<sub>4</sub>"

## Wundhaken – Wound Retractors

Wundhaken, tiefe Form

Retractors, Deep Form

Maßangaben für Blattgrößen der Wundhaken

1. Zahl = Tiefe Beispiel: 25 x 38 mm

2. Zahl = Breite

Dimensions for blade size of retractors

1st number = depth Example: 25 x 38 mm

2nd number = width

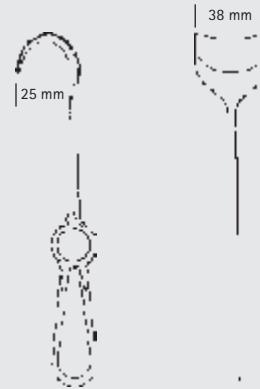

**BT278R**

8 Zähne, stumpf  
8 prongs, blunt

**BT279R**

8 Zähne, halbscharf  
8 prongs, semi-sharp

KÖRTE

**BT278R-BT279R**

Griff vertikal zum Blatt

Handle vertical to the blade

240 mm, 9 1/2"



KÖRTE

**BT280R**

4 Zähne, stumpf

Griff vertikal zum Blatt

4 prongs, blunt

handle vertical to the blade

230 mm, 9"



KÖRTE-WAGNER

**BT290R**

8 Zähne, halbscharf

8 prongs, semi-sharp

280 mm, 11"



**Wundhaken – Wound Retractors**  
 Wundhaken, tiefe Form  
 Retractors, Deep Form

**BT**

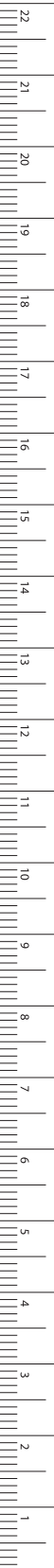

1/2

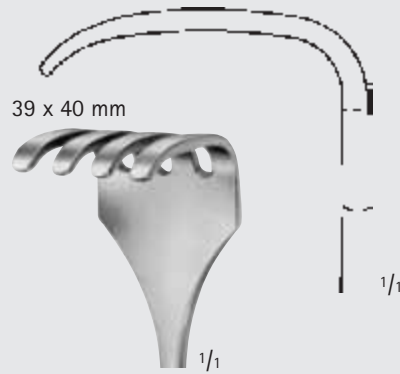

**BT284R**  
 4 Zähne, stumpf  
 4 prongs, blunt

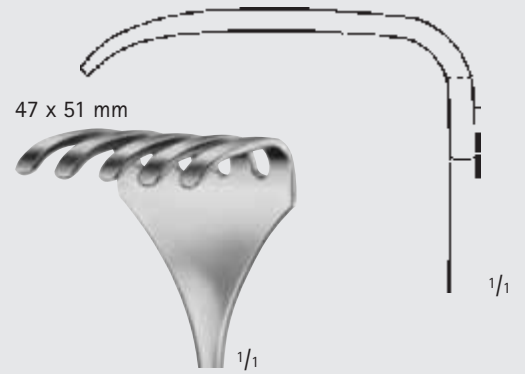

**BT285R**  
 5 Zähne, stumpf  
 5 prongs, blunt

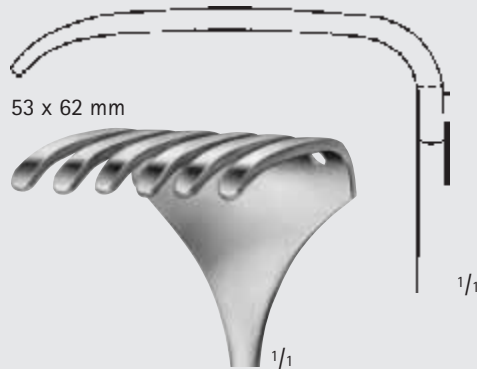

**BT286R**  
 6 Zähne, stumpf  
 6 prongs, blunt

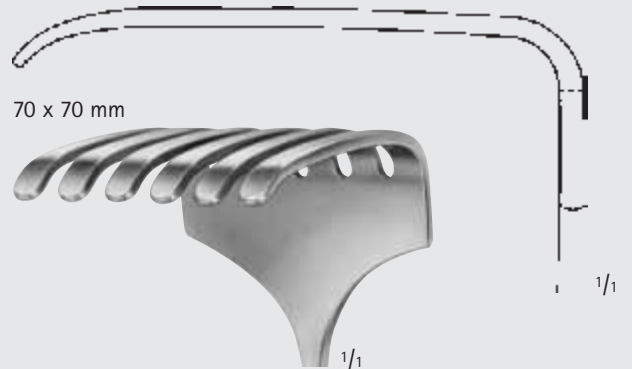

**BT287R**  
 6 Zähne, stumpf  
 6 prongs, blunt

ISRAEL

**BT284R-BT287R**

255 mm, 10"

## Wundhaken – Wound Retractors

Wundhaken

Retractors

Maßangaben für Blattgrößen der Wundhaken

1. Zahl = Tiefe Beispiel: 25 x 38 mm

2. Zahl = Breite

Dimensions for blade size of retractors

1st number = depth Example: 25 x 38 mm

2nd number = width

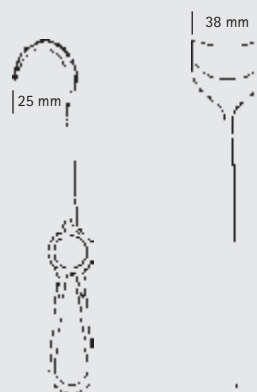

OLLIER

**BT288R**

4 Zähne, stumpf

4 prongs, blunt

230 mm, 9"



LANGENBECK

**BT311R-BT316R**

230 mm, 9"

BT





# Wundhaken – Wound Retractors

Wundhaken  
Retractors

BT

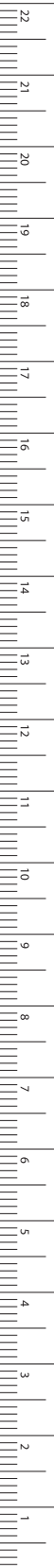

MILLIMETERS



LANGENBECK

**BT320R-BT326R**

210 mm, 8 1/4"

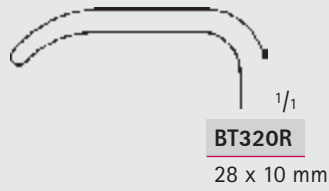

**BT320R**

28 x 10 mm



**BT321R**

28 x 14 mm

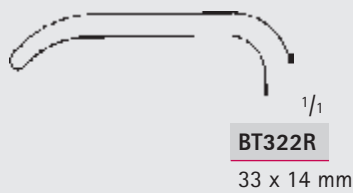

**BT322R**

33 x 14 mm

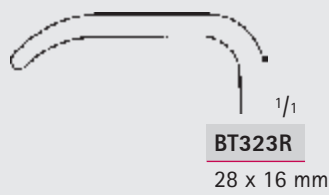

**BT323R**

28 x 16 mm



**BT325R**

40 x 10 mm

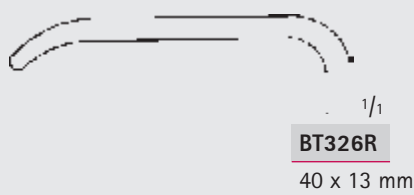

**BT326R**

40 x 13 mm

# Wundhaken – Wound Retractors

Wundhaken  
Retractors

Maßangaben für Blattgrößen der Wundhaken

1. Zahl = Tiefe Beispiel: 25 x 38 mm

2. Zahl = Breite

Dimensions for blade size of retractors

1st number = depth Example: 25 x 38 mm

2nd number = width

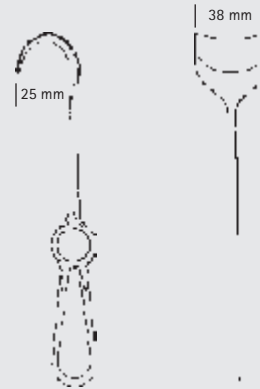

1/2

KOCHER-LANGENBECK

**BT354R-BT365R**

215 mm, 8 1/2"

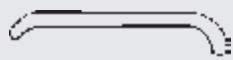

1/1

**BT354R**

25 x 6 mm



1/1

**BT356R**

35 x 8 mm



1/1

**BT357R**

35 x 11 mm

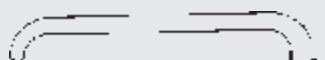

1/1

**BT358R**

35 x 15 mm

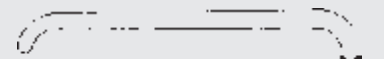

1/1

**BT359R**

41 x 11 mm

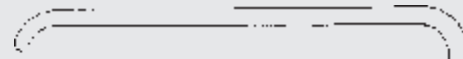

1/1

**BT361R**

55 x 11 mm

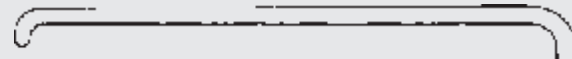

1/1

**BT363R**

70 x 14 mm



1/1

**BT364R**

80 x 12 mm

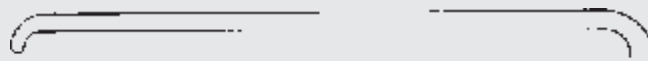

1/1

**BT365R**

80 x 16 mm





# Wundhaken – Wound Retractors

Wundhaken  
Retractors

BT



MILLIMETERS

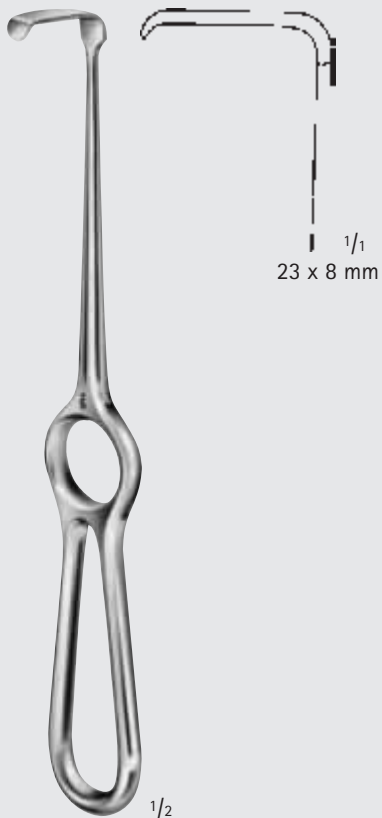

**BT340R**

210 mm, 8 1/4"

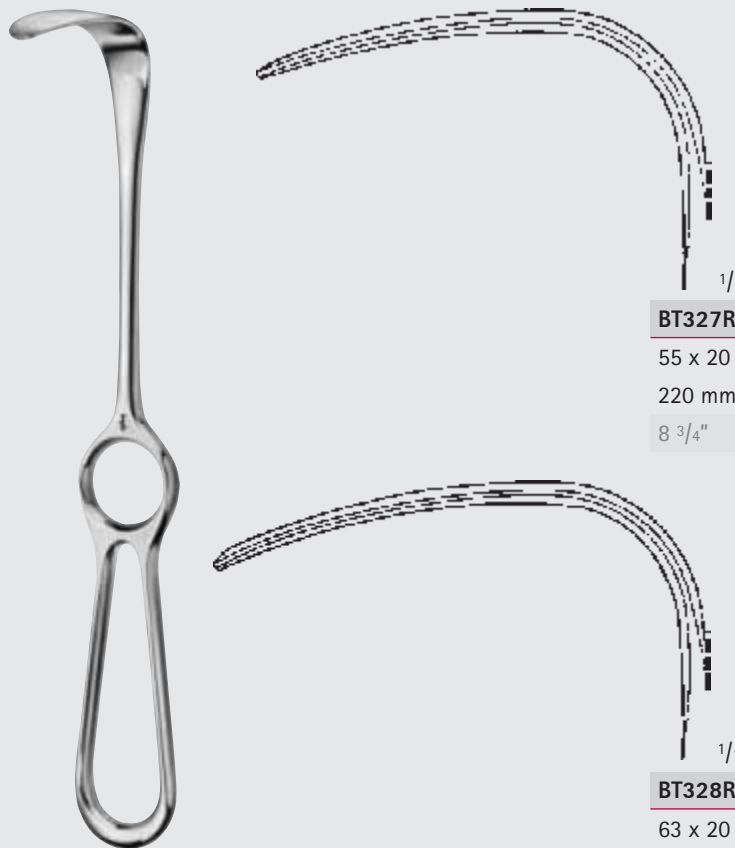

**BT327R**

55 x 20 mm

220 mm

8 3/4"

**BT328R**

63 x 20 mm

210 mm

8 1/4"

**BT327R-BT328R**

## Wundhaken – Wound Retractors

Wundhaken  
Retractors

Maßangaben für Blattgrößen der Wundhaken

1. Zahl = Tiefe Beispiel: 25 x 38 mm

2. Zahl = Breite

Dimensions for blade size of retractors

1st number = depth Example: 25 x 38 mm

2nd number = width

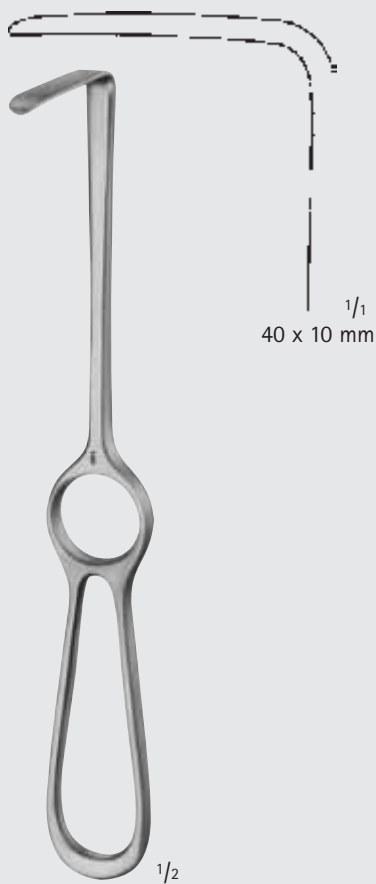
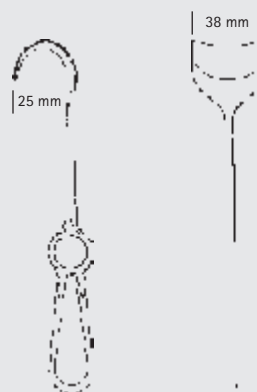

**BT343R**

215 mm, 8 1/2"



**LANGENBECK**

**BT332R**

Griff vertikal zum Blatt

Handle vertical to the blade

215 mm, 8 1/2"



**Wundhaken – Wound Retractors**  
 Wund- und Meniskushaken  
 Retractors and Knee Retractors

**BT**

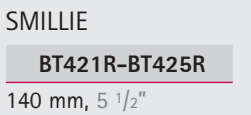
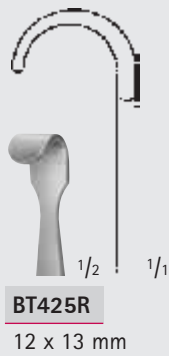
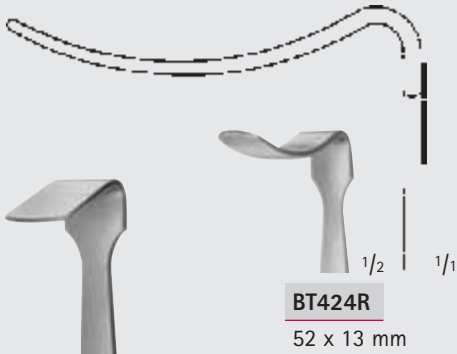
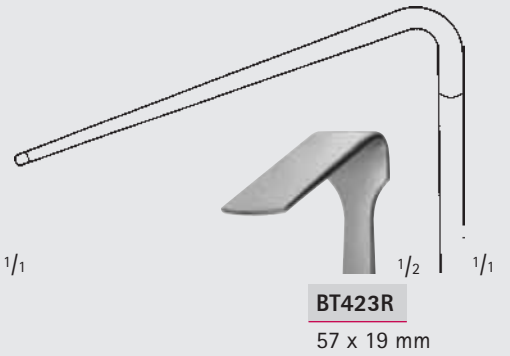
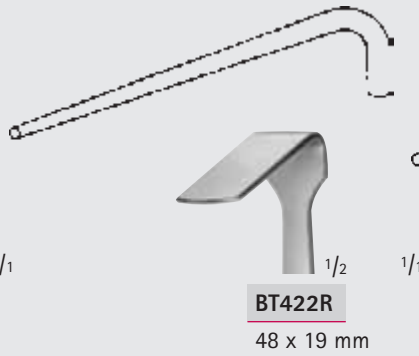
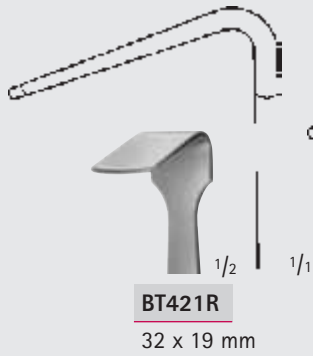

MILLIMETERS

# Wundhaken – Wound Retractors

## Wund- und Meniskushaken

### Retractors and Knee Retractors

Maßangaben für Blattgrößen der Wundhaken

1. Zahl = Tiefe Beispiel: 25 x 38 mm

2. Zahl = Breite

Dimensions for blade size of retractors

1st number = depth Example: 25 x 38 mm

2nd number = width

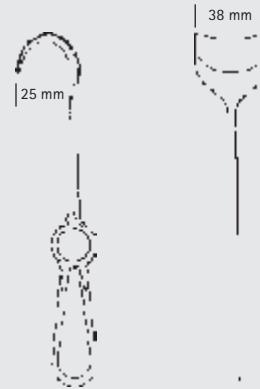

**BT419R**

225 mm, 9"

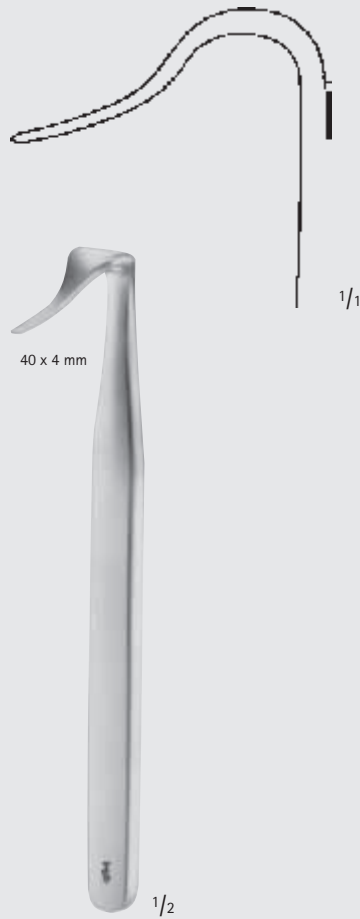

**BLOUNT**

**BT420R**

175 mm, 7"

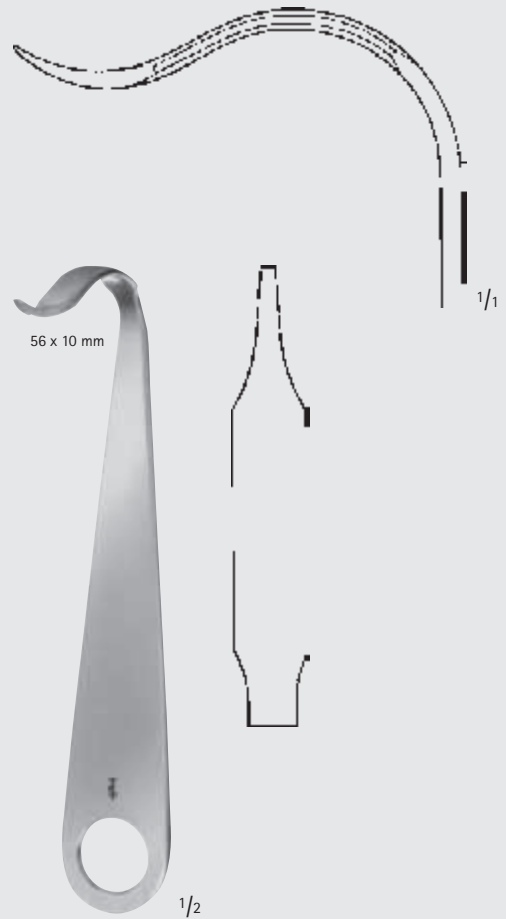

**BT430R**

170 mm, 6 3/4"

BT





**Wundhaken – Wound Retractors**  
Wundhaken  
Retractors

**BT**

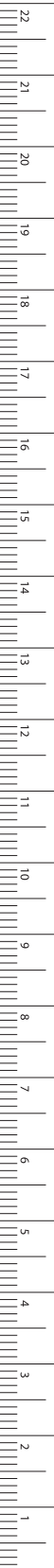

MILLIMETERS

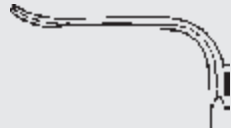

**D0450R**  
25 x 7 mm



**D0451R**  
31 x 10 mm

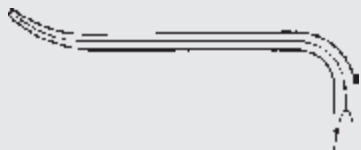

**D0452R**  
42 x 11 mm



**D0453R**  
55 x 12 mm



**D0454R**  
70 x 14 mm

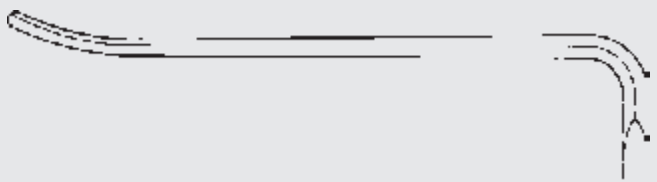

**D0455R**  
80 x 16 mm



OBWEGESER

**D0450R-D0455R**

215 mm, 8 1/2"

# Wundhaken – Wound Retractors

Wundhaken

Retractors

Maßangaben für Blattgrößen der Wundhaken

1. Zahl = Tiefe                      Beispiel: 25 x 38 mm

2. Zahl = Breite

Dimensions for blade size of retractors

1st number = depth                Example: 25 x 38 mm

2nd number = width

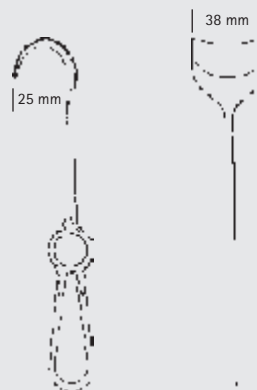

OBWEGESER

**DO460R-DO465R**

215 mm, 8 1/2"

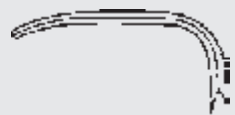

**DO460R**

25 x 7 mm



**DO461R**

31 x 10 mm



**DO462R**

42 x 11 mm

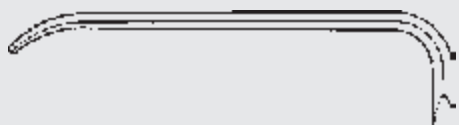

**DO463R**

55 x 12 mm

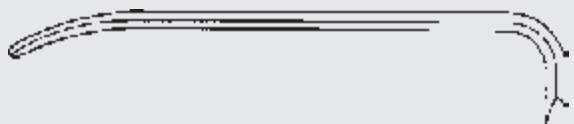

**DO464R**

70 x 14 mm



**DO465R**

80 x 16 mm

BT





# Wundhaken – Wound Retractors

Wundhaken  
Retractors

BT

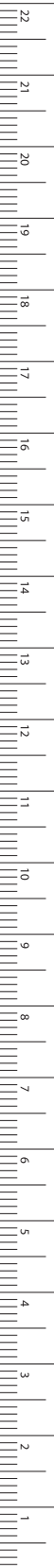

KOCHER

**BT369R-BT373R**

230 mm, 9"

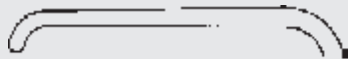

**BT369R**

40 x 18 mm

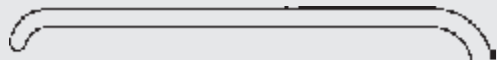

**BT370R**

60 x 20 mm



**BT371R**

60 x 25 mm



**BT372R**

75 x 30 mm

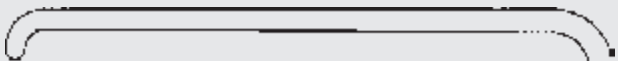

**BT373R**

75 x 40 mm

1/1

MILLIMETERS

# Wundhaken – Wound Retractors

Wundhaken  
Retractors

Maßangaben für Blattgrößen der Wundhaken

1. Zahl = Tiefe                      Beispiel: 25 x 38 mm

2. Zahl = Breite

Dimensions for blade size of retractors

1st number = depth                  Example: 25 x 38 mm

2nd number = width

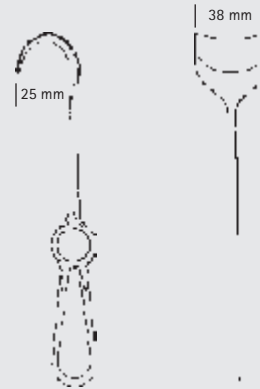

SAUERBRUCH

**BT351R-BT353R**

225 mm, 9"



**BT351R**

46 x 16 mm



**BT352R**

55 x 22 mm



**BT353R**

72 x 19 mm

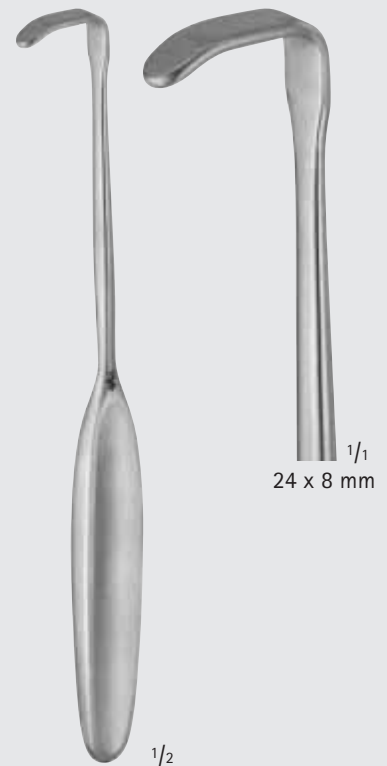

LAHEY

**MB785R**

200 mm, 8"

BT







**Wundhaken – Wound Retractors**  
Wundhaken  
Retractors

**BT**

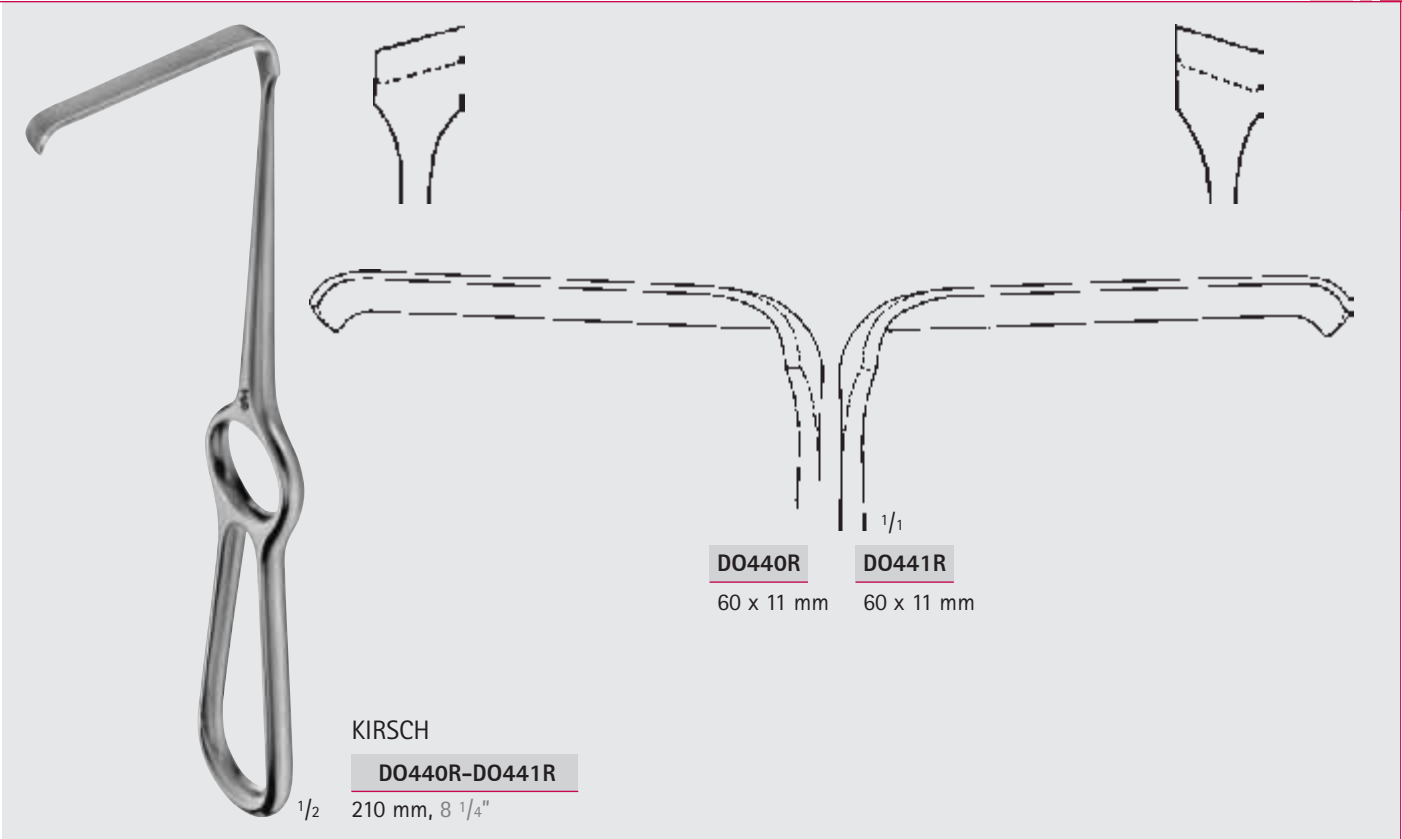

**DO440R**  
60 x 11 mm

**DO441R**  
60 x 11 mm

**KIRSCH**  
**DO440R-DO441R**  
1/2 210 mm, 8 1/4"



1/1  
16 x 25 mm

1/2  
**DURHAM**  
**BT400R**  
215 mm, 8 1/2"



# Wundhaken – Wound Retractors

Wundhaken

Retractors

Maßangaben für Blattgrößen der Wundhaken

1. Zahl = Tiefe Beispiel: 25 x 38 mm

2. Zahl = Breite

Dimensions for blade size of retractors

1st number = depth Example: 25 x 38 mm

2nd number = width

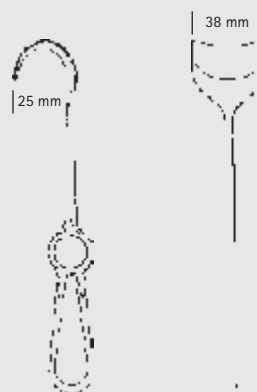

BT



**BT404R**

15 x 15 mm

220 mm

8 3/4"

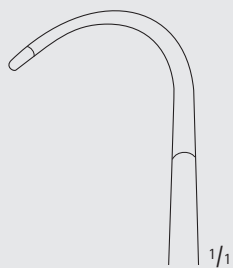

**BT405R**

20 x 22 mm

215 mm

8 1/2"



**BT406R**

28 x 28 mm

235 mm

9 1/4"

MIDDELDORPF

BT404R-BT406R



22 x 22 mm

GREENE

BT408R

225 mm, 9"



# Wundhaken – Wound Retractors

Wundhaken  
Retractors

BT



BÜCHS

DO432R

205 mm, 8"

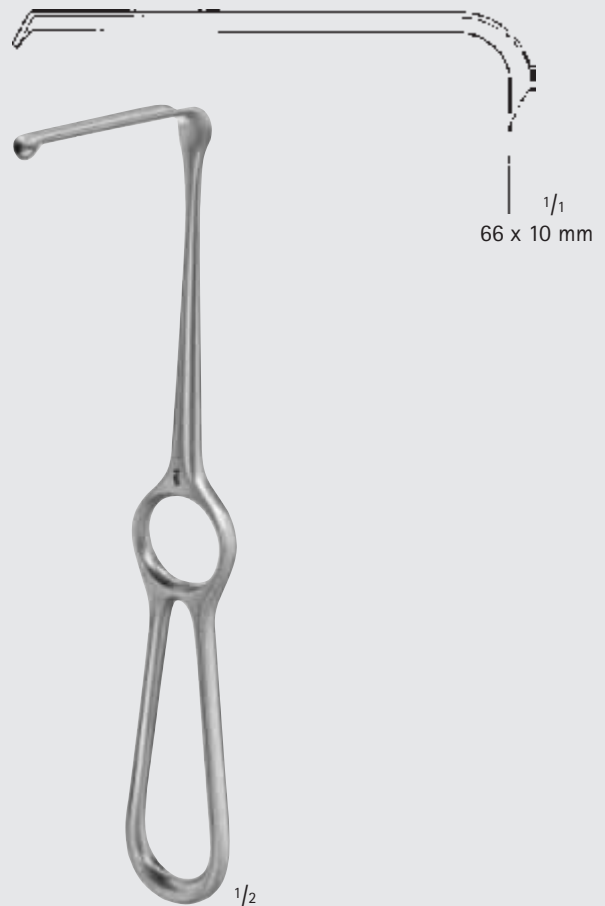

KRÄMER

BT464R

210 mm, 8 1/4"

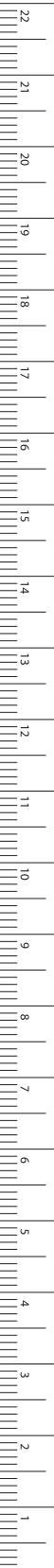

MILLIMETERS

# Wundhaken – Wound Retractors

Wundhaken  
Retractors

Maßangaben für Blattgrößen der Wundhaken

1. Zahl = Tiefe                      Beispiel: 25 x 38 mm

2. Zahl = Breite

Dimensions for blade size of retractors

1st number = depth                  Example: 25 x 38 mm

2nd number = width

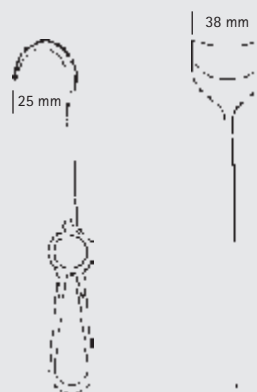

BT

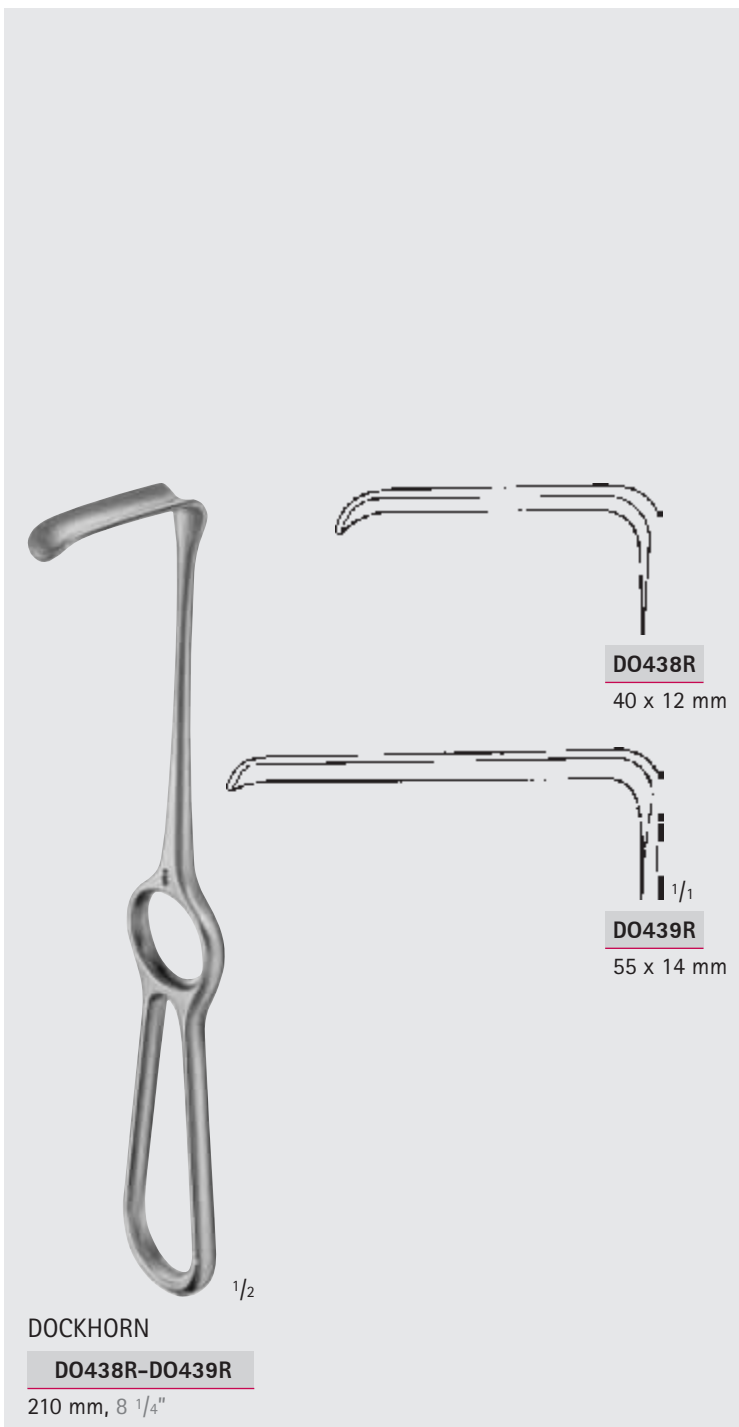
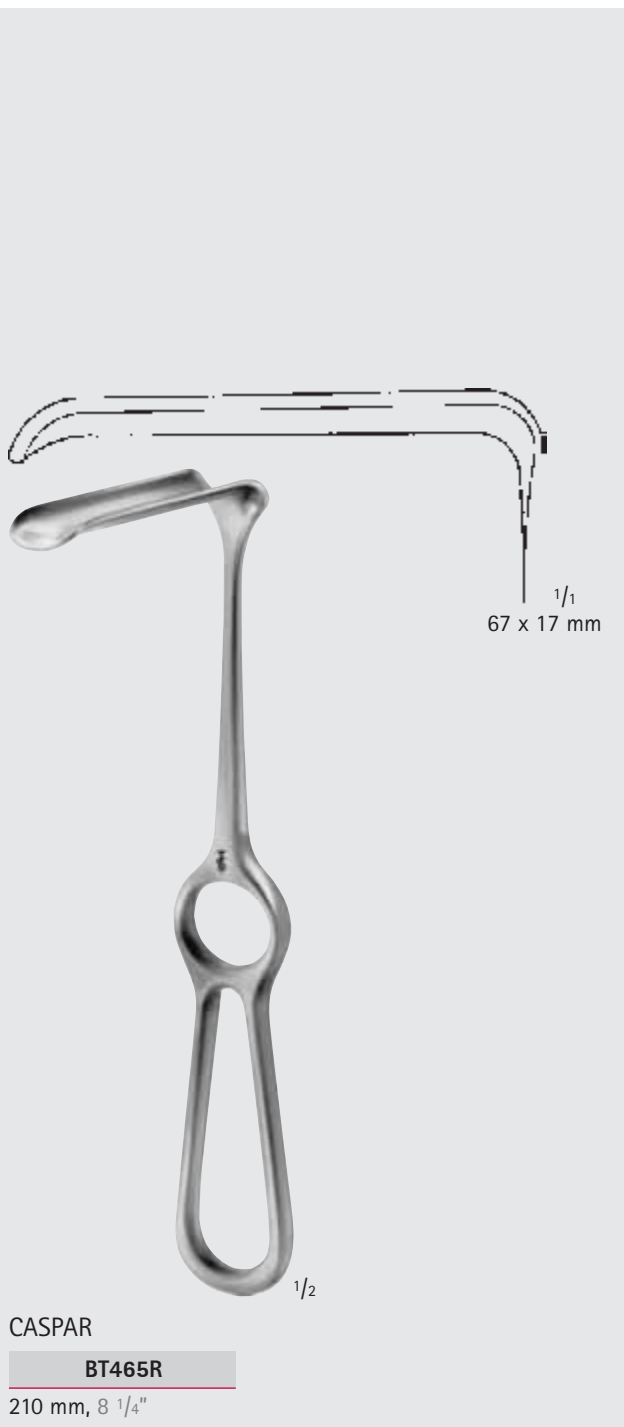



# Wundhaken – Wound Retractors

Wundhaken  
Retractors

BT

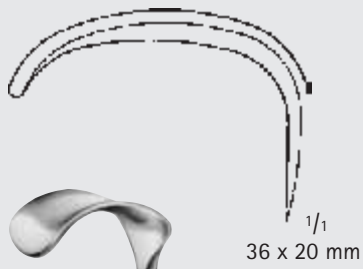

36 x 20 mm

KOCHER

**BT459R**

230 mm, 9"

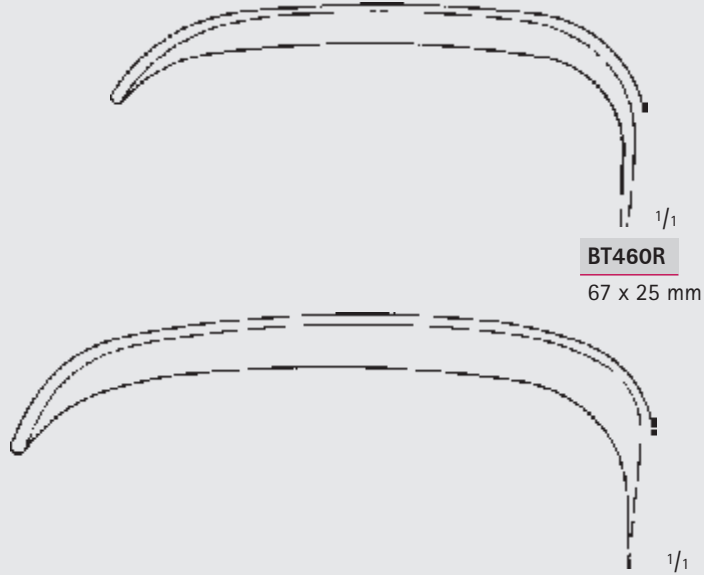

**BT460R**

67 x 25 mm

**BT461R**

80 x 42 mm

**BT462R**

80 x 50 mm

**BT463R**

80 x 60 mm



KOCHER

**BT460R-BT463R**

250 mm, 10"

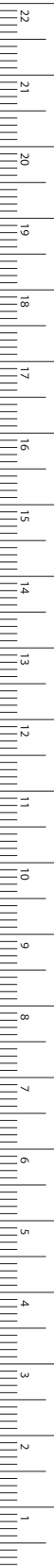

MILLIMETERS

# Wundhaken – Wound Retractors

Wundhaken  
Retractors

Maßangaben für Blattgrößen der Wundhaken

1. Zahl = Tiefe                      Beispiel: 25 x 38 mm

2. Zahl = Breite

Dimensions for blade size of retractors

1st number = depth                  Example: 25 x 38 mm

2nd number = width

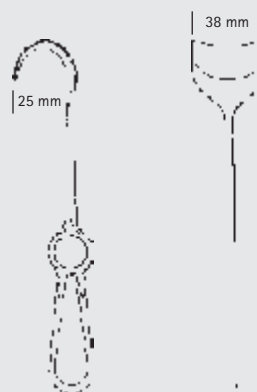



# Wundhaken – Wound Retractors

Wundhaken  
Retractors

**BT**

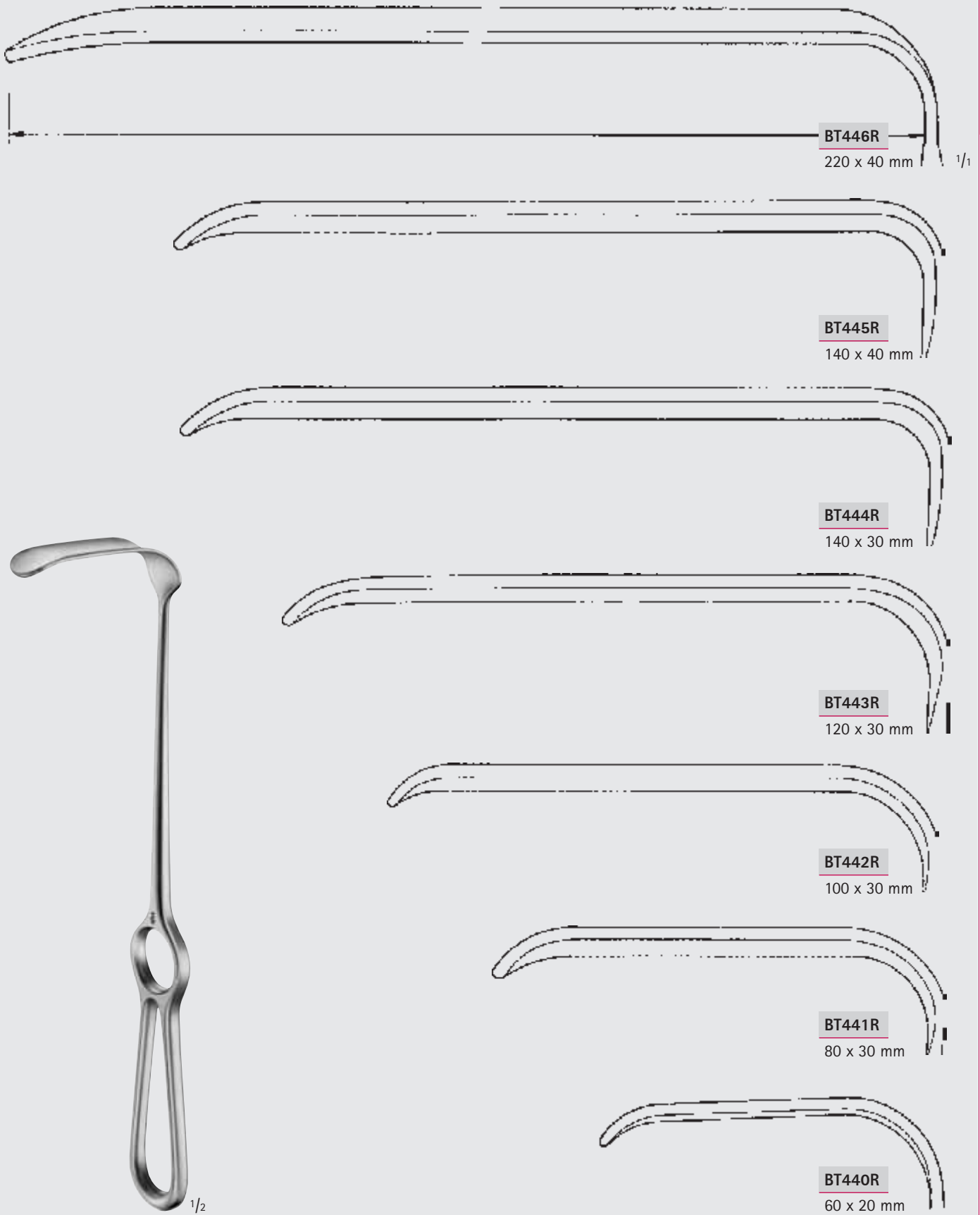

**BT446R**

220 x 40 mm

1/2

**BT445R**

140 x 40 mm

**BT444R**

140 x 30 mm

**BT443R**

120 x 30 mm

**BT442R**

100 x 30 mm

**BT441R**

80 x 30 mm

**BT440R**

60 x 20 mm

1/2

HÖSEL

**BT440R-BT446R**

250 mm, 10"

MILLIMETERS

## Wundhaken – Wound Retractors

Wundhaken

Retractors

Maßangaben für Blattgrößen der Wundhaken

1. Zahl = Tiefe Beispiel: 25 x 38 mm

2. Zahl = Breite

Dimensions for blade size of retractors

1st number = depth Example: 25 x 38 mm

2nd number = width

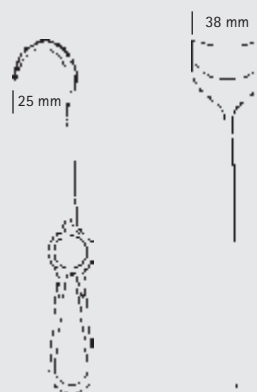

**BT540P**

60 x 40 mm

**BT542P**

100 x 40 mm

**BT545P**

140 x 40 mm

### Wundhaken

- Aus kohlefaserverstärktem Polymer
- Röntgendurchlässig
- Blendfrei
- Autoklavierbar 134°C/ 2 bar
- Hohe Stabilität
- Federleicht - bis zu 65% Gewichtsersparnis zu einem vergleichbaren Stahlhaken

### Retractor

- Made from a carbon fibre reinforced polymer
- X-ray translucent
- Non-glare finish
- Autoclavable 134°C / 2 bar
- High stability
- Feather light - up to 65% weight reduction compared to an equivalent stainless steel retractor

**BT540P-BT545P**

255 mm, 10"

INCHES





## Wundhaken – Wound Retractors

Wundhaken  
Retractors

**BT**



MILLIMETERS



RICHARDSON-EASTMAN

**BT470R**

Satz komplett,  
bestehend aus:

Set complete,  
consisting of:

BT471R  
BT472R

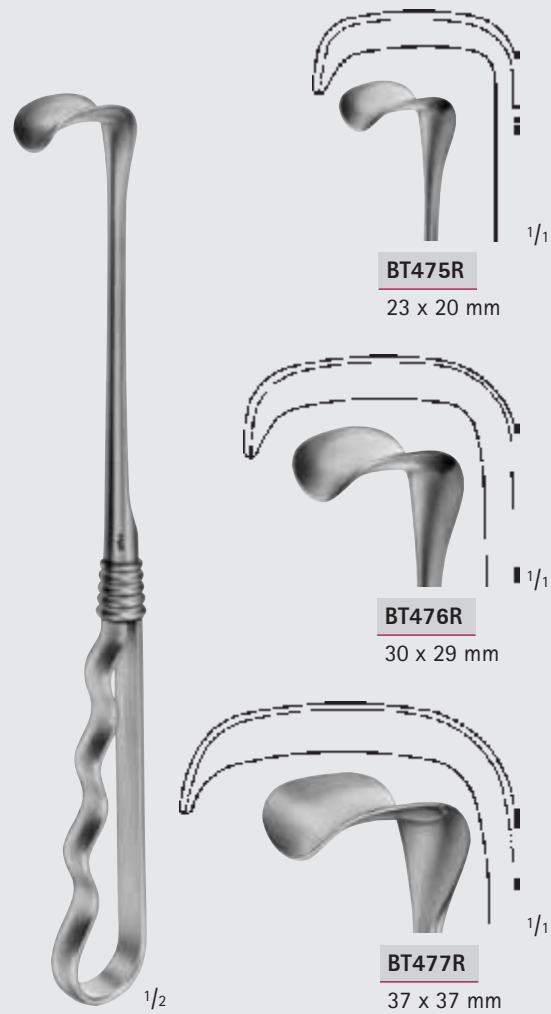

RICHARDSON

**BT475R-BT477R**

240 mm, 9 1/2"

## Wundhaken – Wound Retractors

Wundhaken  
Retractors

Maßangaben für Blattgrößen der Wundhaken

1. Zahl = Tiefe Beispiel: 25 x 38 mm

2. Zahl = Breite

Dimensions for blade size of retractors

1st number = depth Example: 25 x 38 mm

2nd number = width

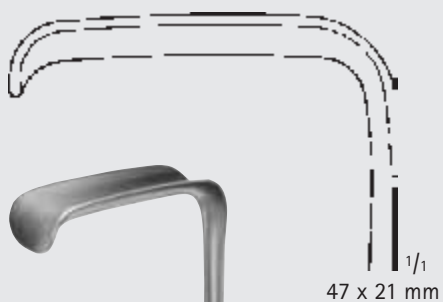
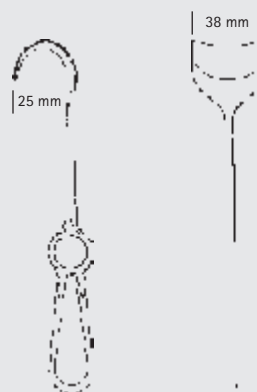

RICHARDSON

**BT478R**

240 mm, 9 1/2"



RICHARDSON

**BT479R**

250 mm, 10"





**Wundhaken – Wound Retractors**  
Wundhaken  
Retractors

**BT**

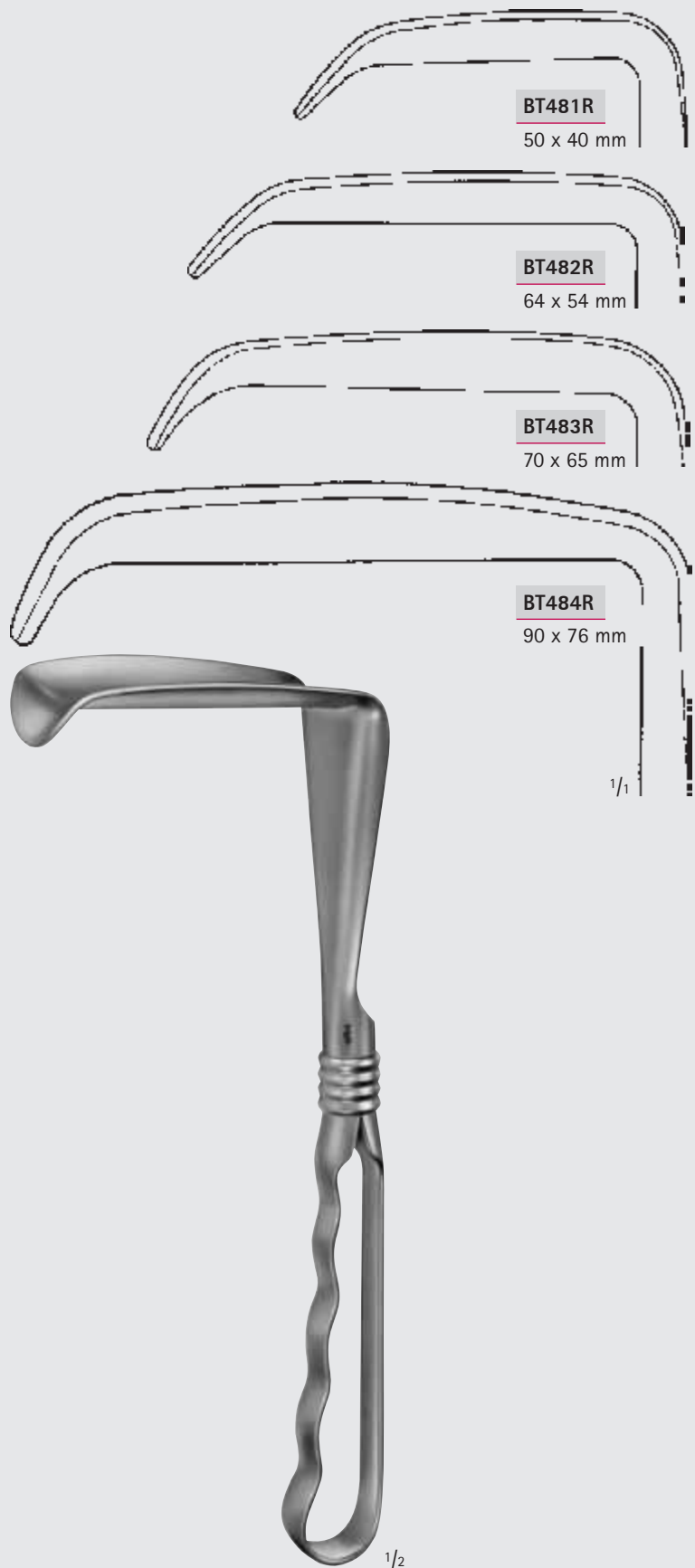

**BT481R**

50 x 40 mm

**BT482R**

64 x 54 mm

**BT483R**

70 x 65 mm

**BT484R**

90 x 76 mm

1/1

1/2

**KELLY**

**BT481R-BT484R**

260 mm, 10 1/4"

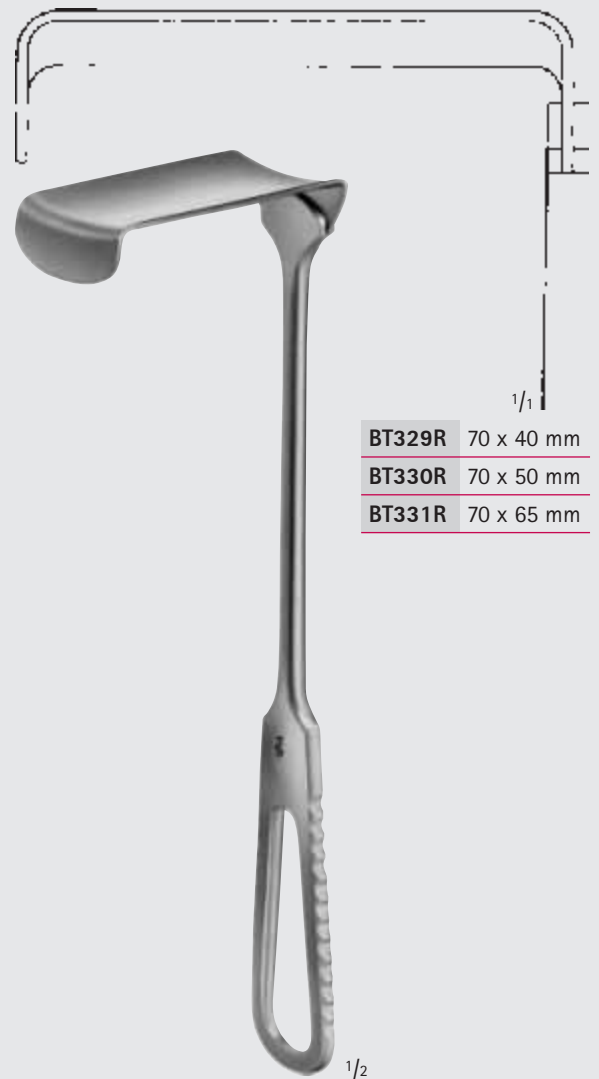

**BT329R** 70 x 40 mm

**BT330R** 70 x 50 mm

**BT331R** 70 x 65 mm

1/1

1/2

**MORRIS**

**BT329R-BT331R**

245 mm, 9 3/4"

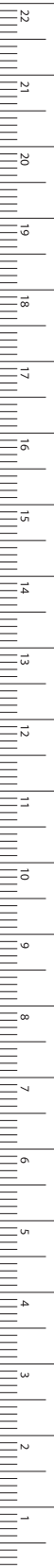

MILLIMETERS

# Wundhaken – Wound Retractors

Wundhaken  
Retractors

Maßangaben für Blattgrößen der Wundhaken

1. Zahl = Tiefe                      Beispiel: 25 x 38 mm

2. Zahl = Breite

Dimensions for blade size of retractors

1st number = depth                  Example: 25 x 38 mm

2nd number = width

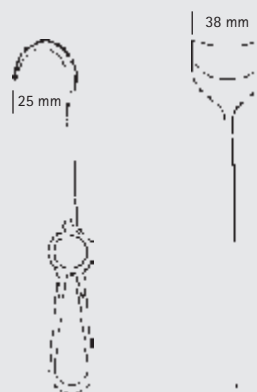

MEYERDING

**BT485R-BT487R**

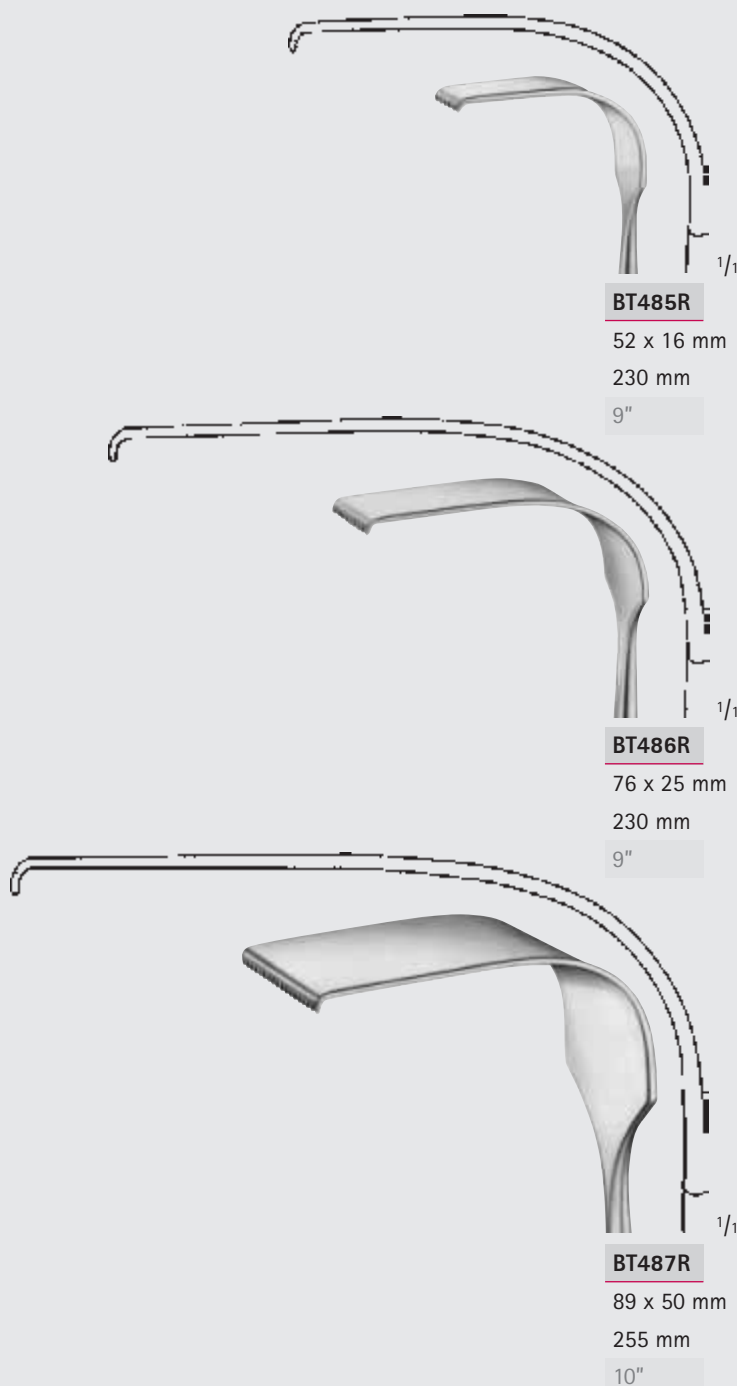

BT





# Wundhaken – Wound Retractors

Wundhaken  
Retractors

BT



115 x 26 mm

115 x 22 mm

105 x 27 mm

95 x 20 mm

1/1

1/1

1/1

1/2

SIMON  
**EL873R**  
275 mm, 10 3/4"

1/2

SIMON  
**EL872R**  
275 mm, 10 3/4"

1/2

MARTIN  
**EL870R**  
250 mm, 10"

1/2

TÜBINGER MODELL  
**EL868R**  
265 mm, 10 1/2"

MILLIMETERS

# Wundhaken – Wound Retractors

Wundhaken  
Retractors

Maßangaben für Blattgrößen der Wundhaken

1. Zahl = Tiefe                      Beispiel: 25 x 38 mm

2. Zahl = Breite

Dimensions for blade size of retractors

1st number = depth                  Example: 25 x 38 mm

2nd number = width

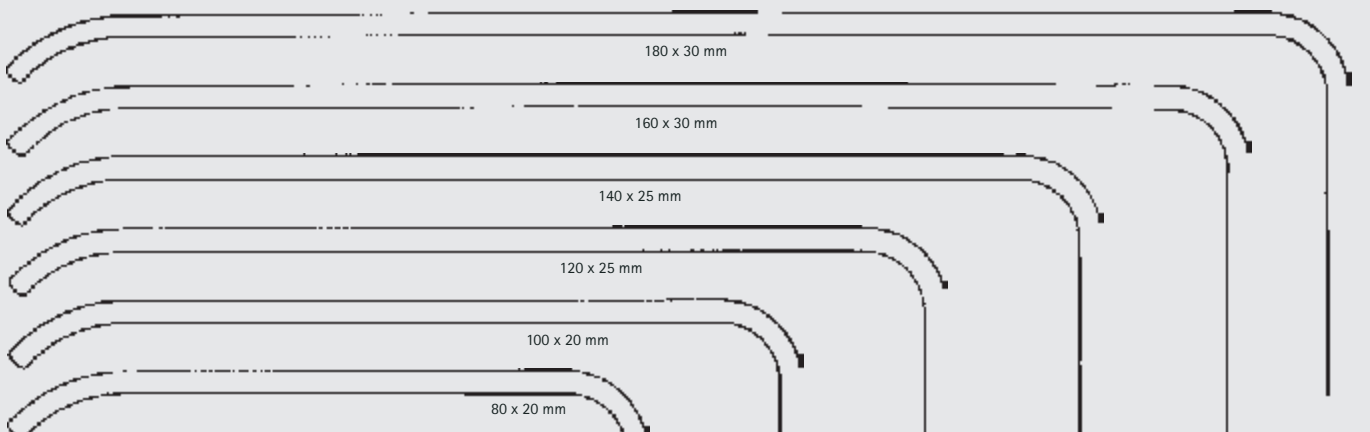
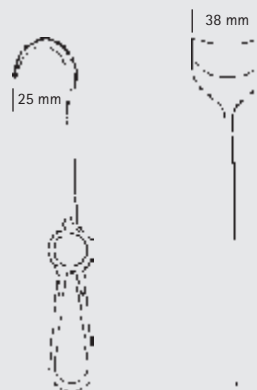

- BT508R
- BT509R
- BT510R
- BT511R
- BT512R
- BT513R

BRUNNER

BT508R-BT513R

<sup>1</sup>/<sub>2</sub> 250 mm, 10"

BT





# Wundhaken – Wound Retractors

Wundhaken  
Retractors

BT

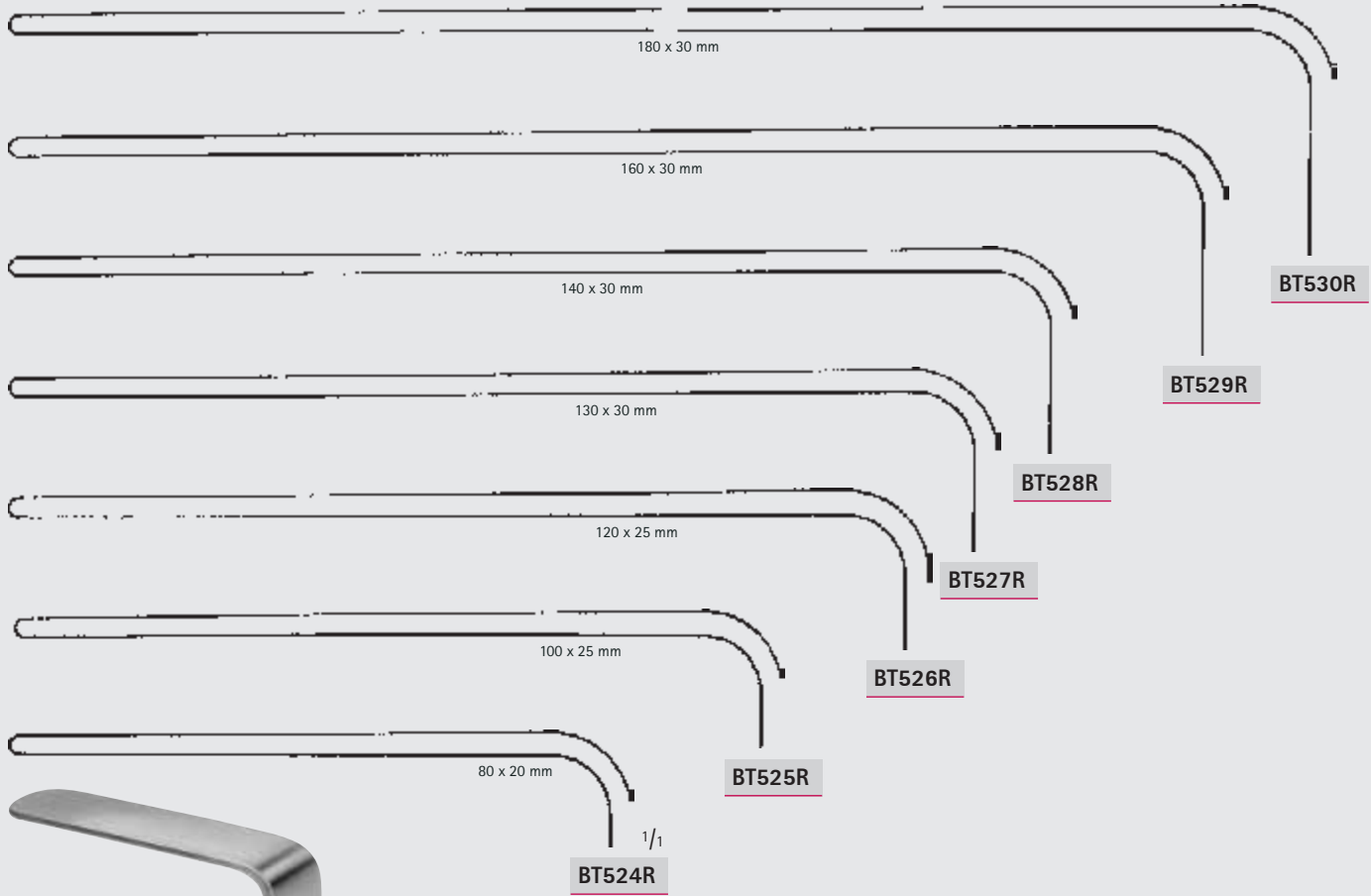

BRUNNER

BT524R-BT530R

$\frac{1}{2}$  275 mm, 10  $\frac{3}{4}$ "

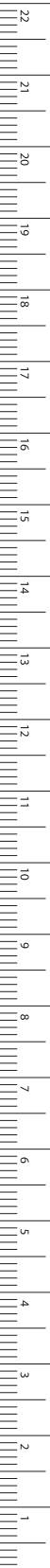

MILLIMETERS

## Wundhaken – Wound Retractors

Varion-Wundhaken-System, DBP

Vario Retractor System, Germ. Fed. Patent

BT

Maßangaben für Blattgrößen der Wundhaken

1. Zahl = Tiefe Beispiel: 25 x 38 mm

2. Zahl = Breite

Dimensions for blade size of retractors

1st number = depth Example: 25 x 38 mm

2nd number = width

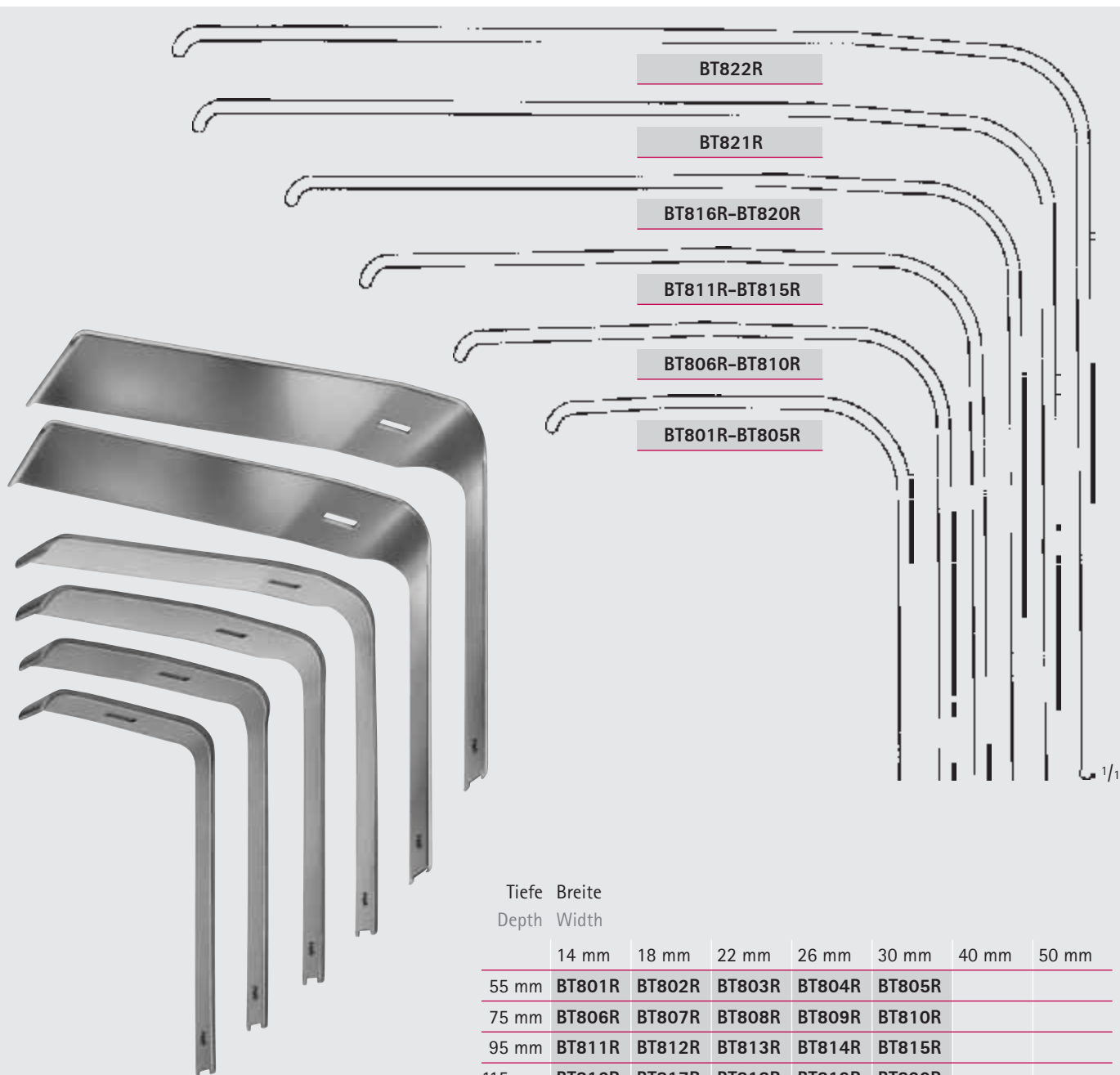
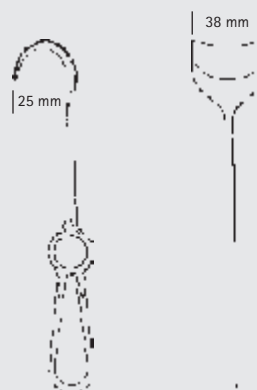

Tiefe Depth	Breite Width						
	14 mm	18 mm	22 mm	26 mm	30 mm	40 mm	50 mm
55 mm	BT801R	BT802R	BT803R	BT804R	BT805R		
75 mm	BT806R	BT807R	BT808R	BT809R	BT810R		
95 mm	BT811R	BT812R	BT813R	BT814R	BT815R		
115 mm	BT816R	BT817R	BT818R	BT819R	BT820R		
135 mm						BT821R	
145 mm							BT822R

Wundhakenblätter  
passend auf die Handgriffe  
BT799R und BT800R.

Retractor blades  
for handles  
BT799R and BT800R.





## Wundhaken – Wound Retractors

Varion-Wundhaken-System, DBP  
Vario Retractor System, Germ. Fed. Patent

Varion-Wundhaken-System mit integriertem Kaltlicht, zur zusätzlichen, intensiven Ausleuchtung des Operationsfeldes, speziell bei komplizierten, in die Tiefe gehenden Eingriffen.

**Zu verwenden mit Aesculap Lichtquellen.**

Vario retractor system with integrated cold light, for additional intensive illumination of deep and complicated operation fields.  
To be used with Aesculap light sources.



Griffstellung variabel  
Handle arrangement variable

**BT800R**

Handgriff mit Kaltlichtleiter,  
zur Aufnahme von  
Wundhakenblätter  
Handle with cold light carrier  
for retractor blades  
280 mm, 11"

**BT799R**

Handgriff mit Kaltlichtleiter,  
zur Aufnahme von  
Wundhakenblättern  
Handle with cold light carrier  
for retractor blades  
180 mm, 7"

BT



MILLIMETERS

## Wundhaken – Wound Retractors

Wundhaken, Lungenspatel

Retractors, Lung Spatulas

Maßangaben für Blattgrößen der Wundhaken

1. Zahl = Tiefe                      Beispiel: 25 x 38 mm

2. Zahl = Breite

Dimensions for blade size of retractors

1st number = depth                Example: 25 x 38 mm

2nd number = width

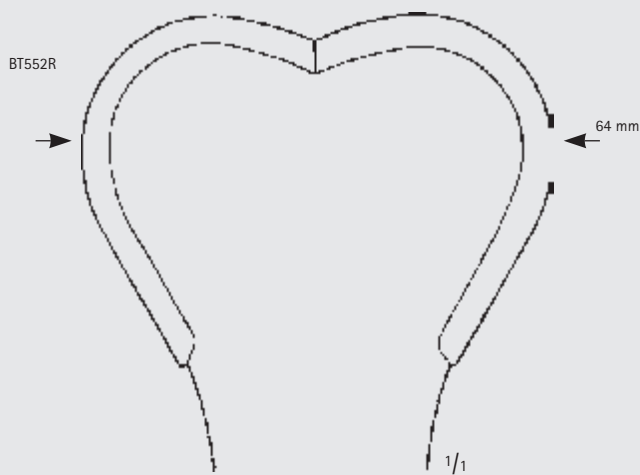
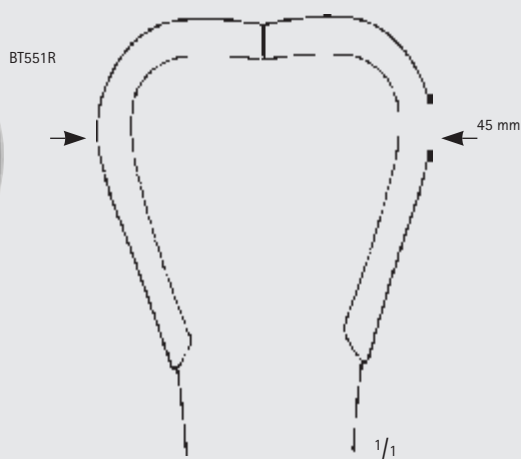
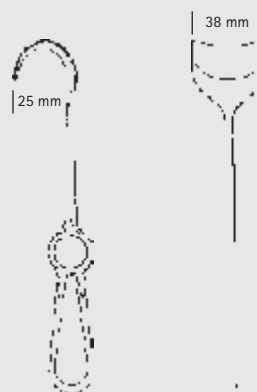

HARRINGTON

**BT551R** 123 x 45 mm

**BT552R** 123 x 64 mm

federnd

flexible

295 mm, 11 3/4"

BT



## Wundhaken – Wound Retractors

Wundhaken, Lungenspatel  
Retractors, Lung Spatulas

BT

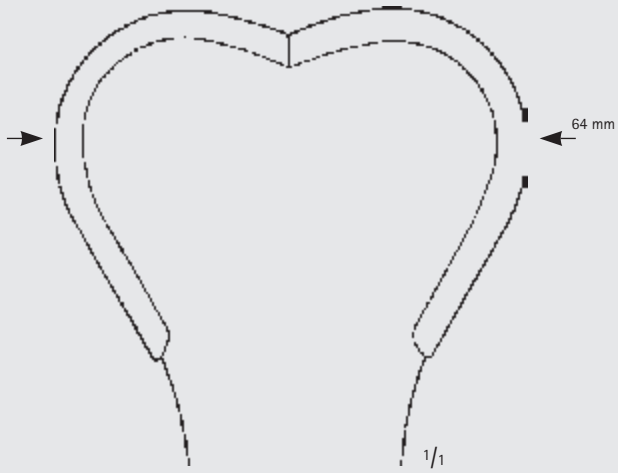

HARRINGTON-PEMBERTON

**BT553R**

175 x 64 mm

federnd

flexible

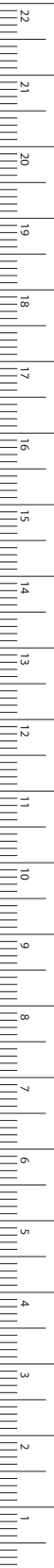

MILLIMETERS

# Wundhaken – Wound Retractors

Lungenspatel

Lung Spatulas

BT

Maßangaben für Blattgrößen der Wundhaken

1. Zahl = Tiefe                      Beispiel: 25 x 38 mm

2. Zahl = Breite

Dimensions for blade size of retractors

1st number = depth                  Example: 25 x 38 mm

2nd number = width

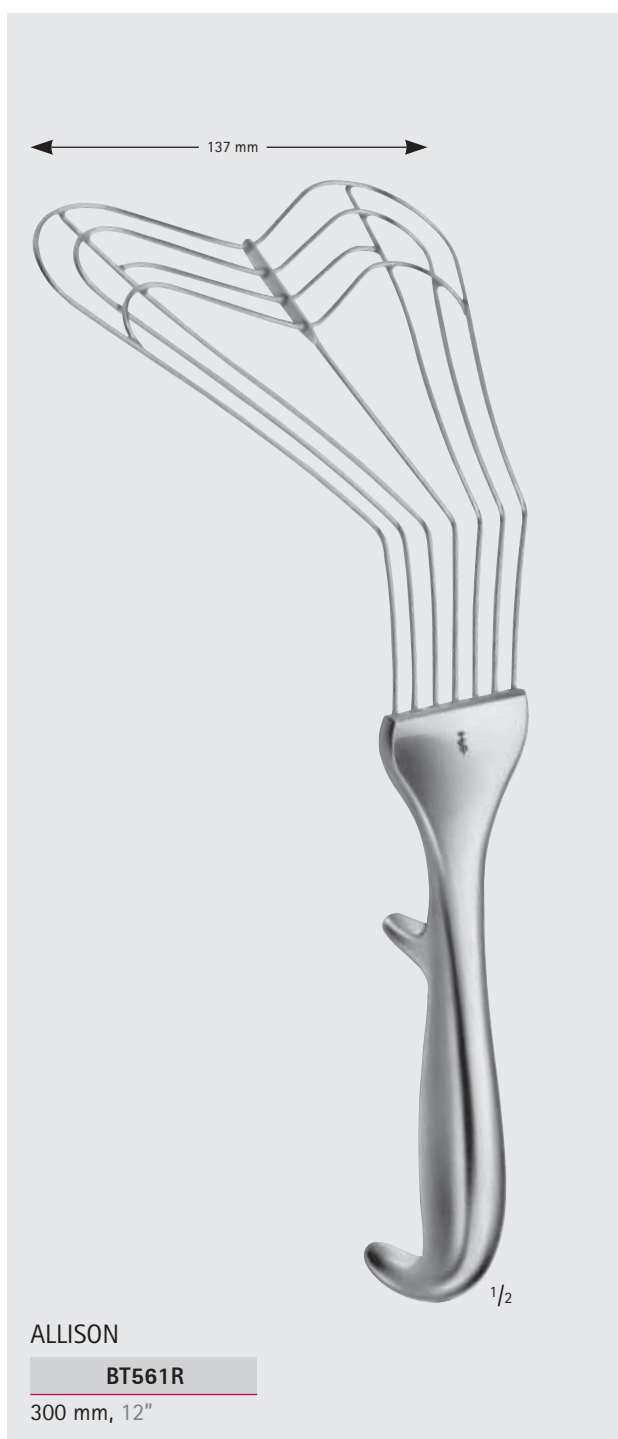
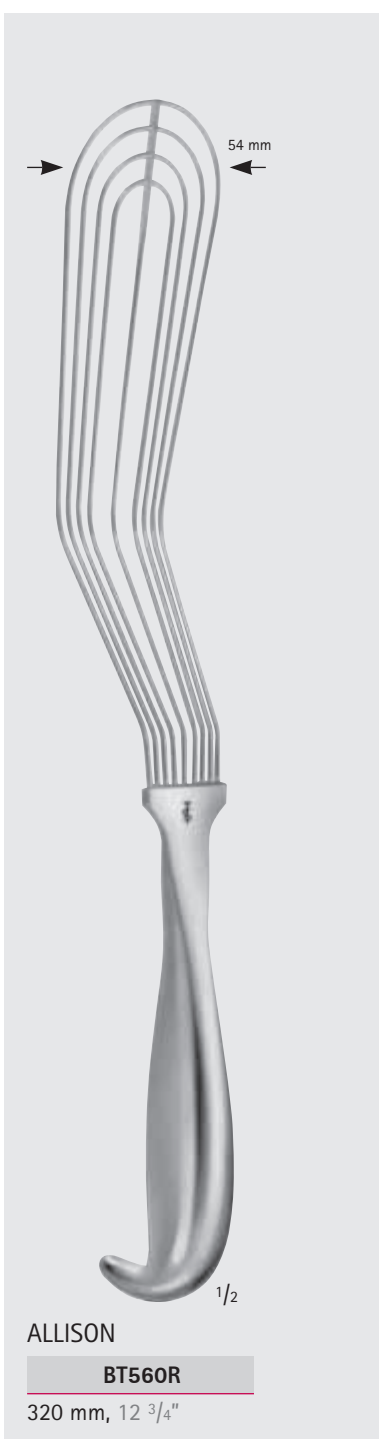
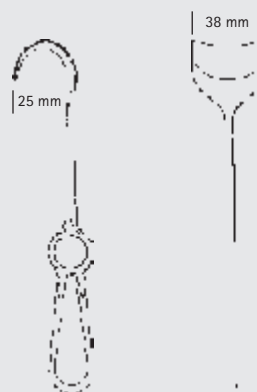



# Wundhaken – Wound Retractors

Wundhaken, Lungenspatel  
Retractors, Lung Spatulas

**BT**

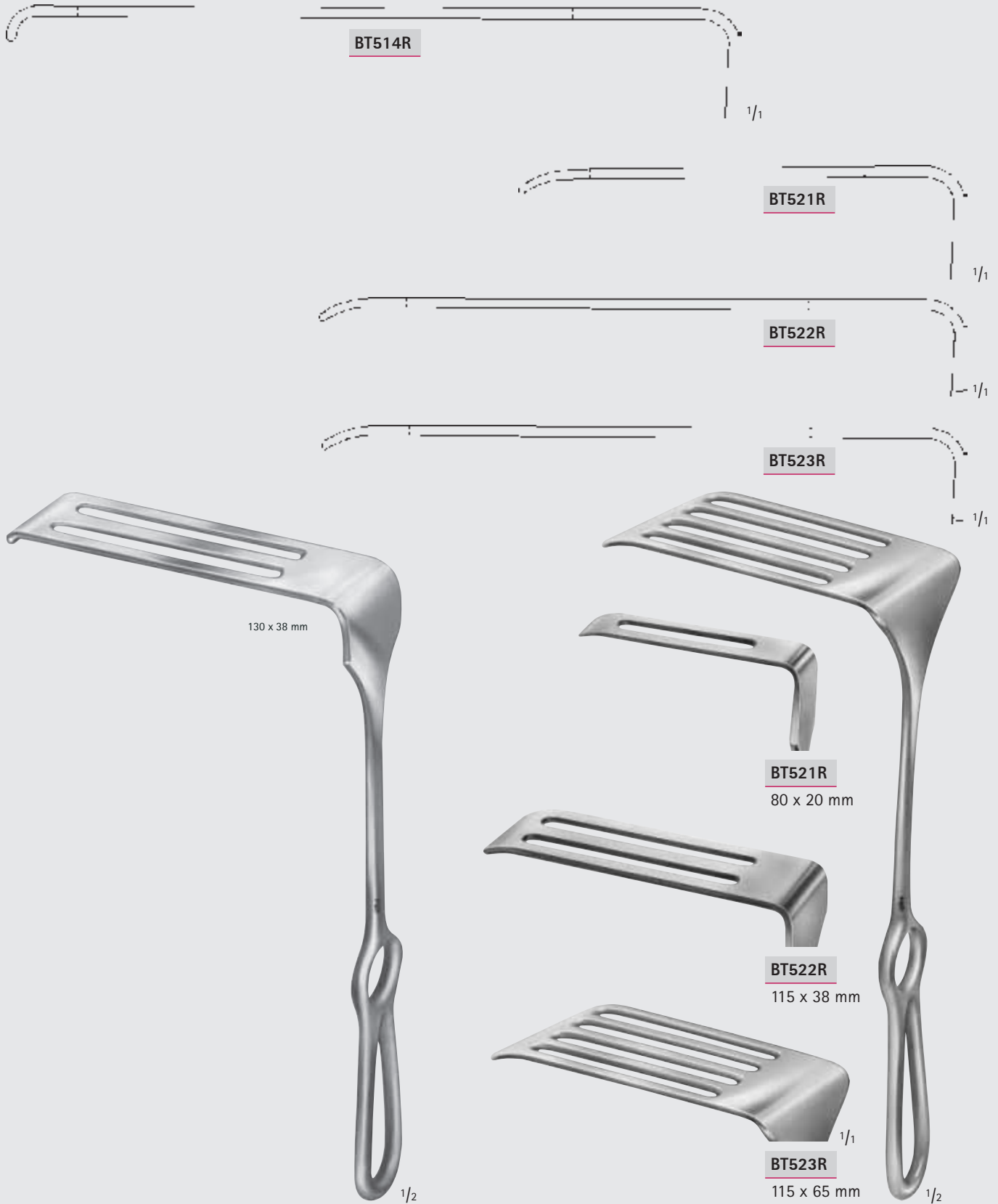

SAUERBRUCH

**BT514R**

260 mm, 10 1/4"

CORYLLOS

**BT521R-BT523R**

255 mm, 10"

MILLIMETERS

# Wundhaken – Wound Retractors

Scapula Haken

Scapula Retractor

Maßangaben für Blattgrößen der Wundhaken

1. Zahl = Tiefe Beispiel: 25 x 38 mm

2. Zahl = Breite

Dimensions for blade size of retractors

1st number = depth Example: 25 x 38 mm

2nd number = width

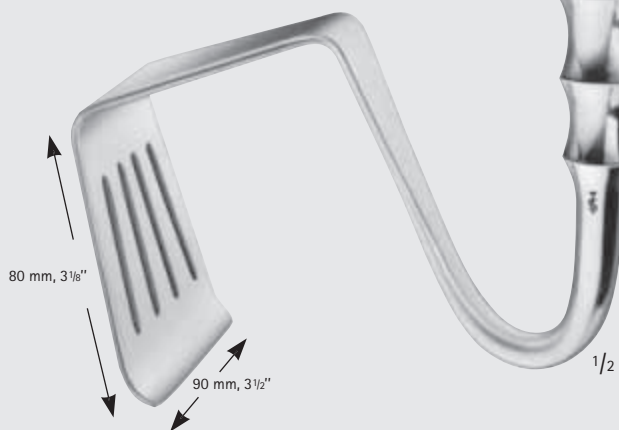
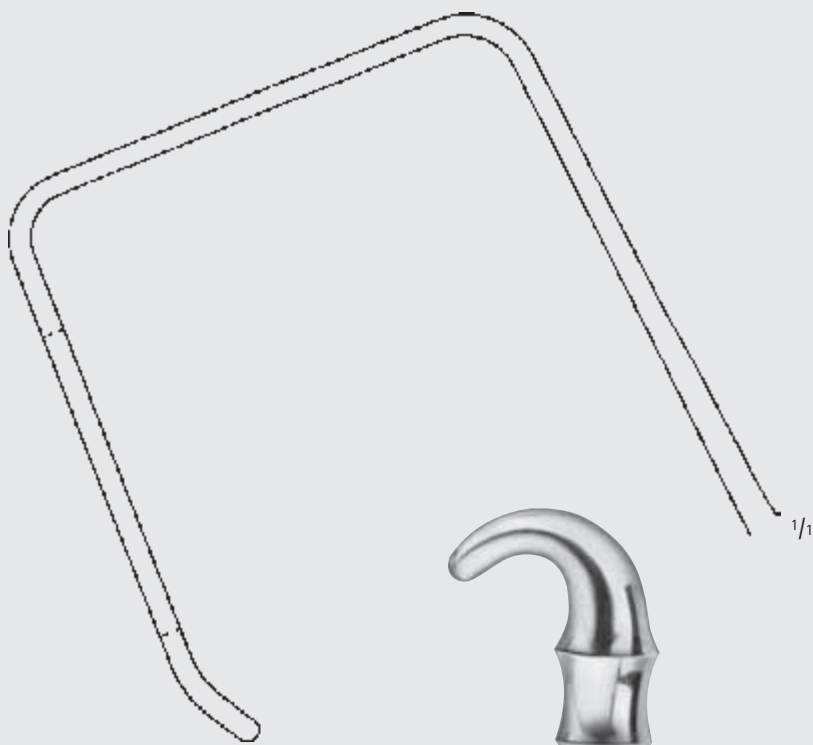
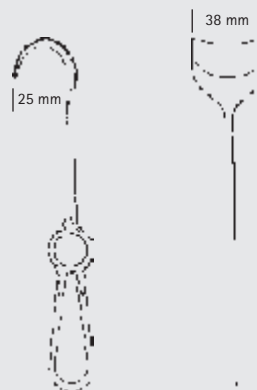

DAVIDSON

BT531R

195 mm, 7 3/4\"/>

BT





**Wundhaken – Wound Retractors**  
Wundhaken  
Retractors

**BT**



# Wundhaken – Wound Retractors

Wundhaken  
Retractors

Maßangaben für Blattgrößen der Wundhaken

1. Zahl = Tiefe                      Beispiel: 25 x 38 mm

2. Zahl = Breite

Dimensions for blade size of retractors

1st number = depth                  Example: 25 x 38 mm

2nd number = width

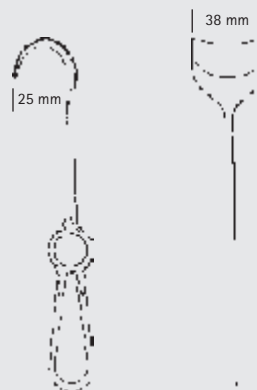

**MD076**  
10 mm  
160 mm  
6 1/4"



**MD077**  
13 mm  
180 mm  
7"

HASSON

**MD076-MD077**

BT







# Wundhaken – Wound Retractors

Wundhaken  
Retractors

BT

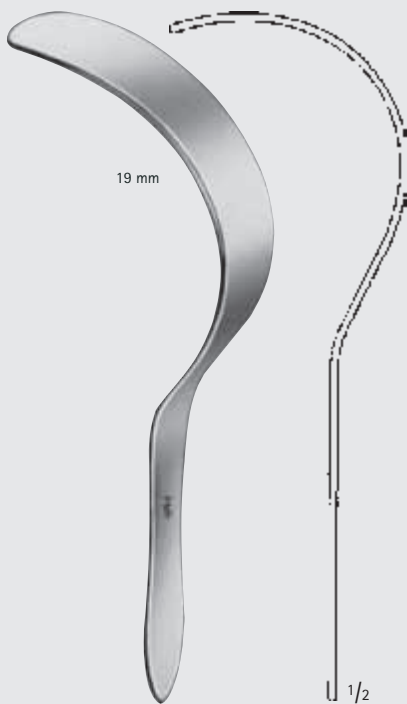

DEAVER

**BT600R**

180 mm, 7"  
Fig. 000

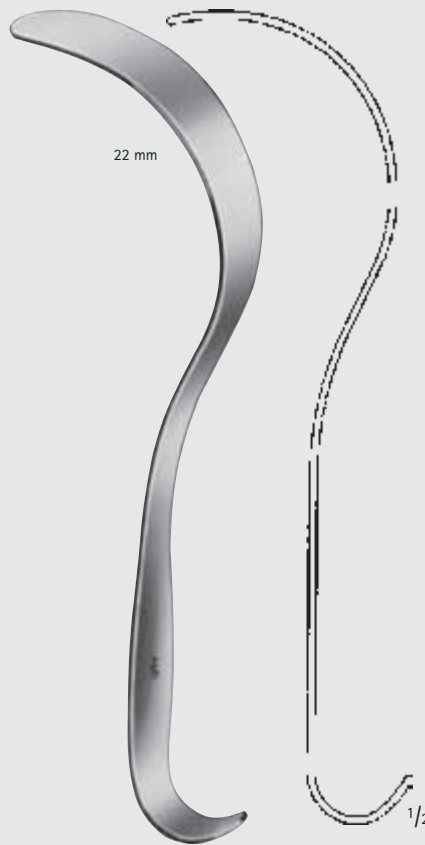

DEAVER

**BT601R**

215 mm, 8 1/2"  
Fig. 00

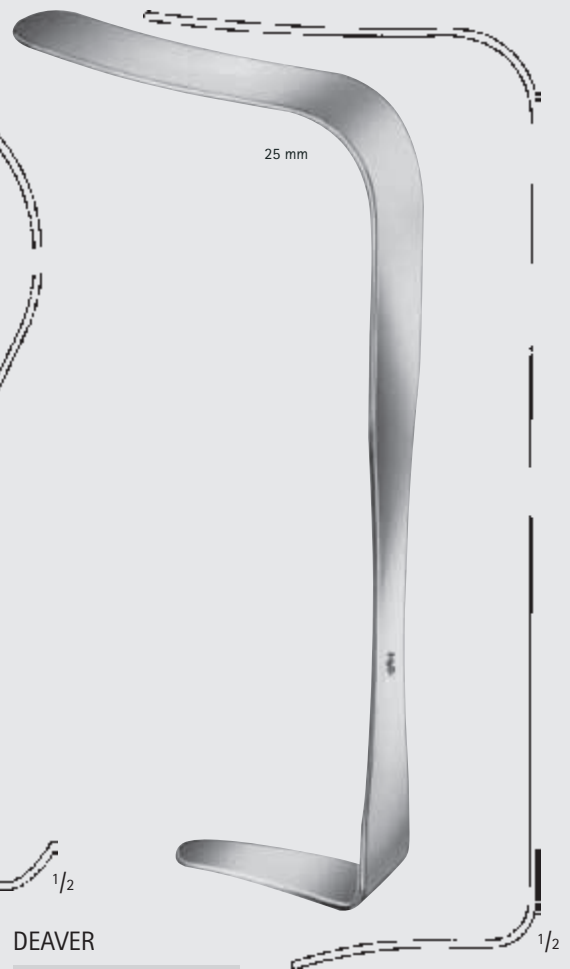

DEAVER

**BT606R**

235 mm, 9 1/4"  
Fig. 0

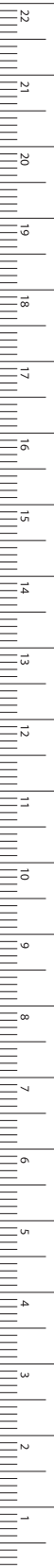

MILLIMETERS

# Wundhaken – Wound Retractors

## Wundhaken Retractors

BT

Maßangaben für Blattgrößen der Wundhaken  
 1. Zahl = Tiefe                      Beispiel: 25 x 38 mm  
 2. Zahl = Breite

Dimensions for blade size of retractors  
 1st number = depth                Example: 25 x 38 mm  
 2nd number = width

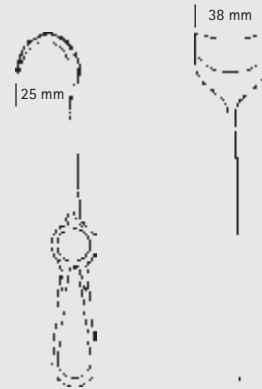

DEAVER  
**BT602R**

Fig. 1  
 300 mm, 12"



DEAVER  
**BT603R**

Fig. 2  
 315 mm, 12 1/2"





# Wundhaken – Wound Retractors

Wundhaken  
Retractors

BT



DEAVER

**BT607R**

Fig. 2 1/2  
365 mm, 14 1/2"



DEAVER

**BT604R**

Fig. 3  
300 mm, 12"

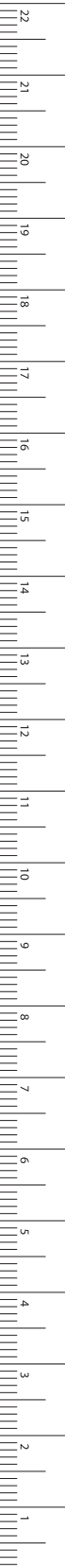

MILLIMETERS

# Wundhaken – Wound Retractors

Wundhaken  
Retractors

Maßangaben für Blattgrößen der Wundhaken

1. Zahl = Tiefe Beispiel: 25 x 38 mm

2. Zahl = Breite

Dimensions for blade size of retractors

1st number = depth Example: 25 x 38 mm

2nd number = width

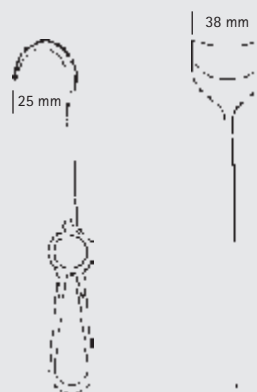

DEAVER

**BT605R**

Fig. 4

310 mm, 12 1/4"

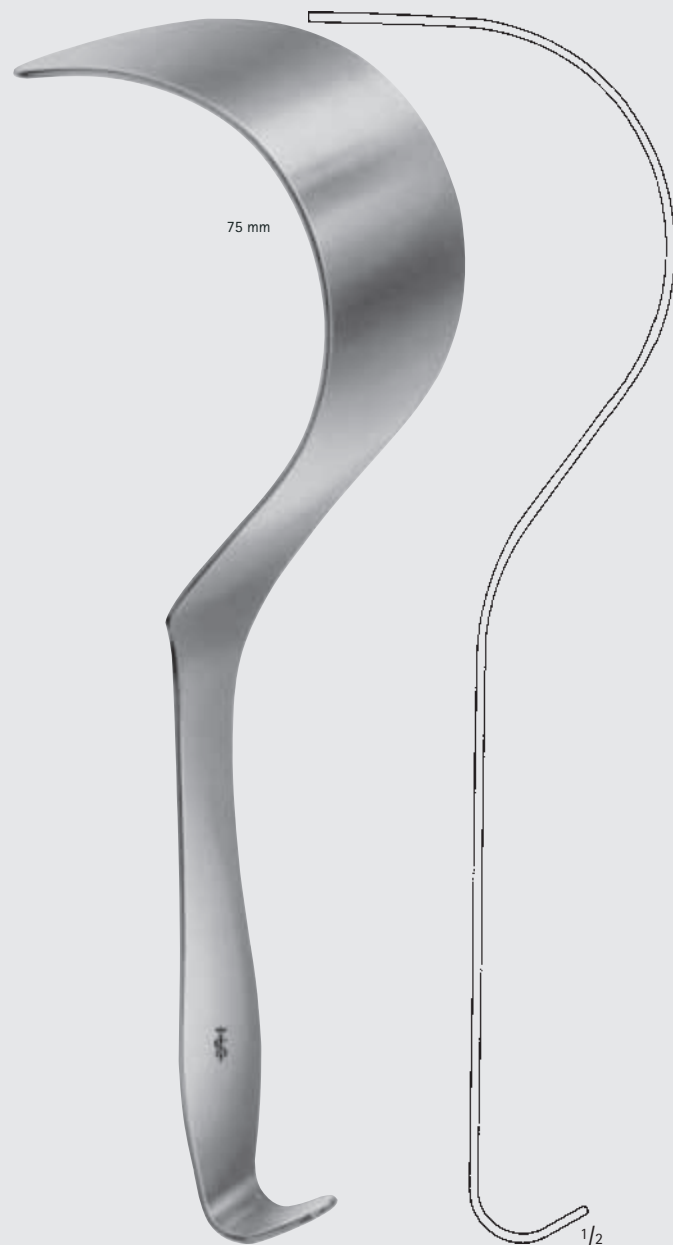

DEAVER

**BT608R**

Fig. 5

320 mm, 12 3/4"

BT





**Wundhaken – Wound Retractors**  
Wundhaken  
Retractors

**BT**



DEAVER

**BT611R**

Fig. 1  
310 mm, 12 1/4"



DEAVER

**BT613R**

Fig. 3  
310 mm, 12 1/4"

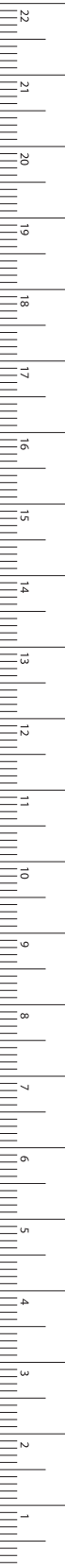

# Wundhaken – Wound Retractors

Wundhaken

Retractors

Maßangaben für Blattgrößen der Wundhaken

1. Zahl = Tiefe Beispiel: 25 x 38 mm

2. Zahl = Breite

Dimensions for blade size of retractors

1st number = depth Example: 25 x 38 mm

2nd number = width

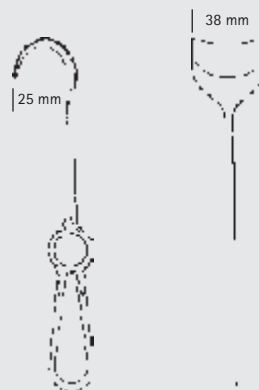

DEAVER

**BT614R**

Fig. 4  
305 mm, 12"



DEAVER

**BT615R**

Fig. 5  
310 mm, 12 1/4"

BT





# Wundhaken – Wound Retractors

Wundhaken  
Retractors

**BT**

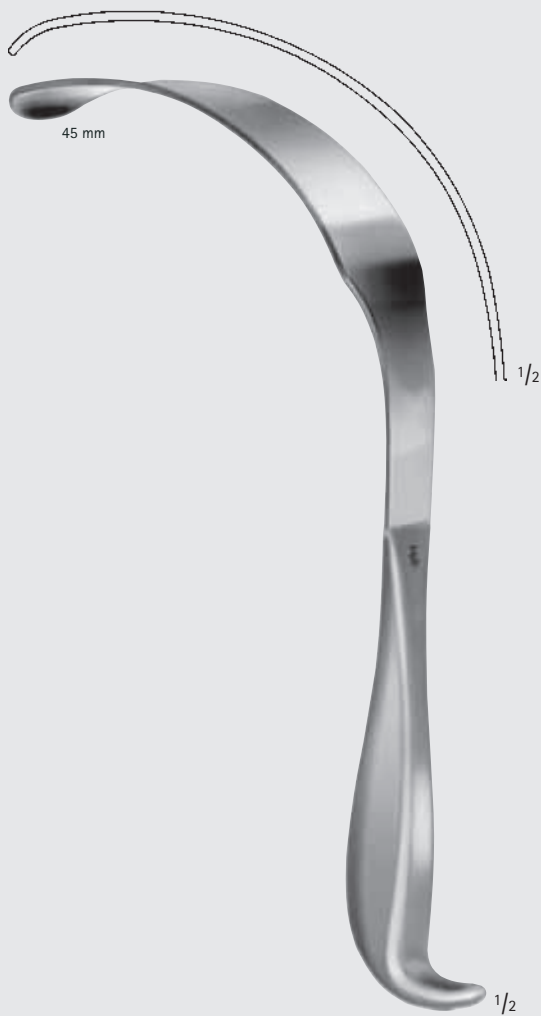

LERICHE

**BT730R**

255 mm, 10"



LERICHE

**BT732R**

275 mm, 10 3/4"

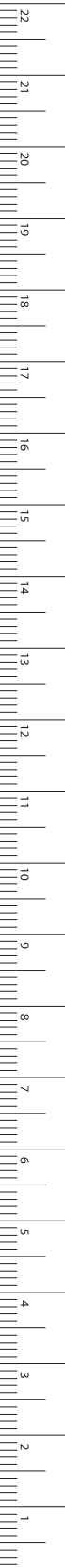

MILLIMETERS

## Wundhaken – Wound Retractors

Wundhaken  
Retractors

Maßangaben für Blattgrößen der Wundhaken

1. Zahl = Tiefe                      Beispiel: 25 x 38 mm

2. Zahl = Breite

Dimensions for blade size of retractors

1st number = depth                Example: 25 x 38 mm

2nd number = width

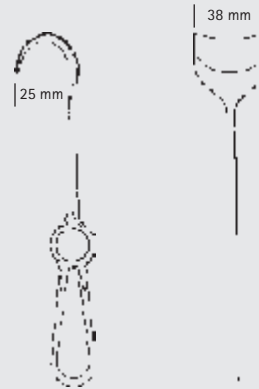

KÜMMEL

**BT740R**

biegsam

malleable

285 mm, 11 1/4"

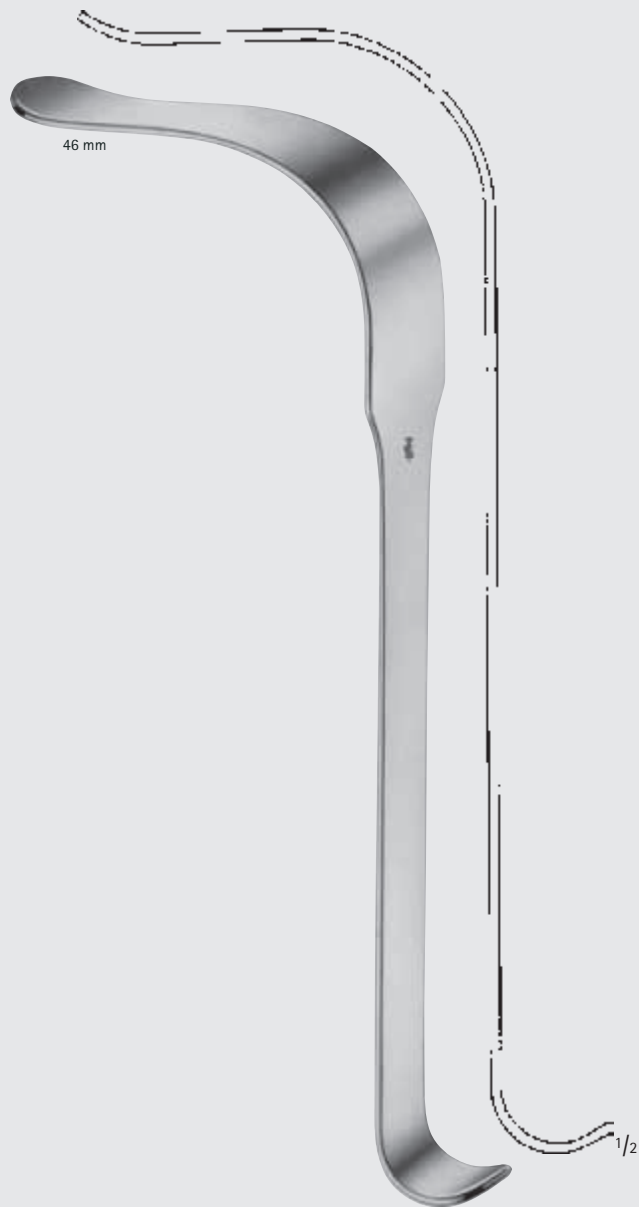

KÖRTE

**BT742R**

300 mm, 12"

BT







## Wundhaken – Wound Retractors

Wundhaken für Eingriffe in der Tiefe (Bauchdeckenhaken)  
Retractors for Deep Surgery (Abdominal Retractors)

BT

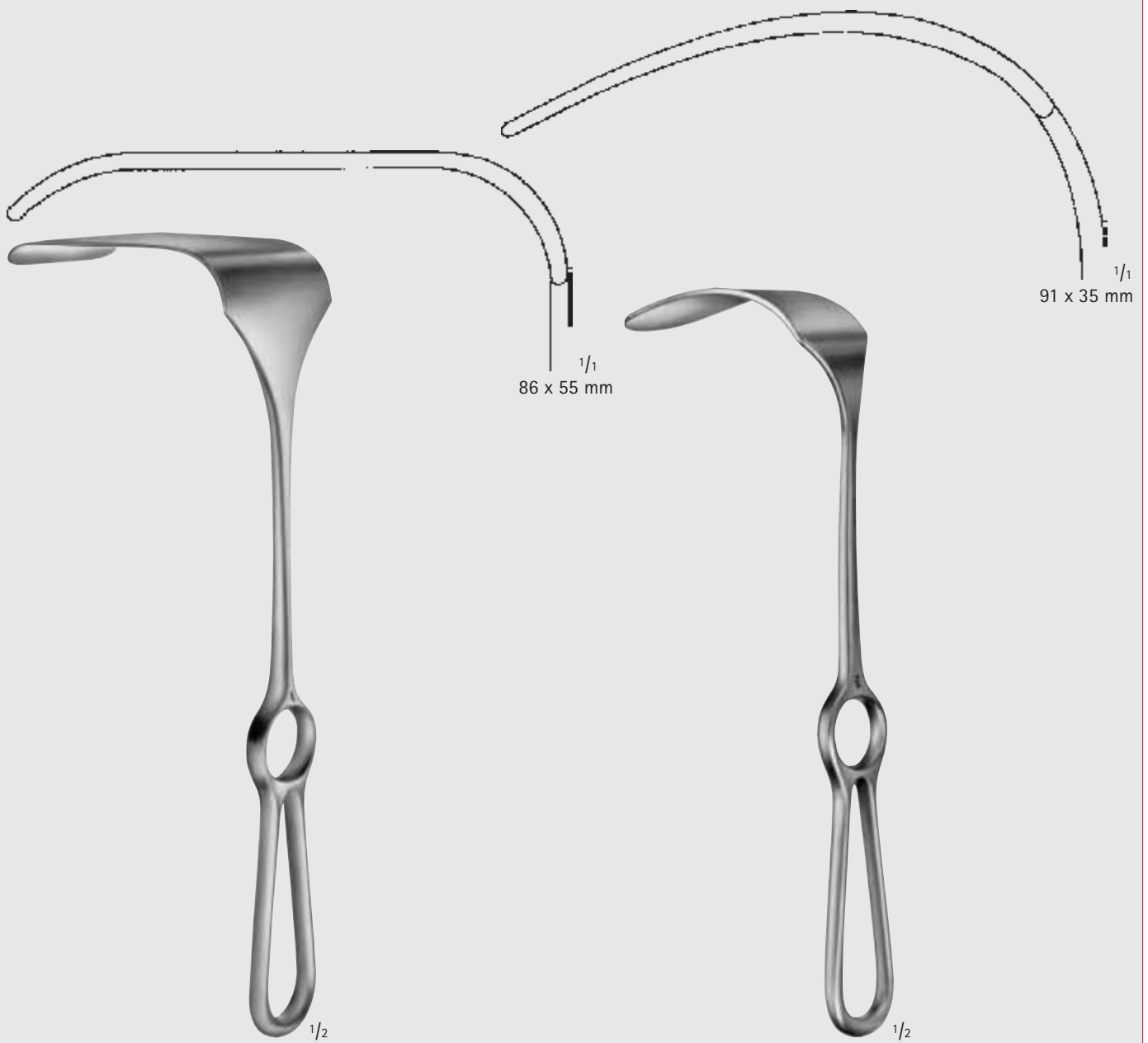

MIKULICZ

**BT618R**

255 mm, 10"

MIKULICZ

**BT621R**

240 mm, 9 1/2"

MILLIMETERS

## Wundhaken – Wound Retractors

Wundhaken für Eingriffe in der Tiefe (Bauchdeckenhaken)

Retractors for Deep Surgery (Abdominal Retractors)

Maßangaben für Blattgrößen der Wundhaken

1. Zahl = Tiefe Beispiel: 25 x 38 mm

2. Zahl = Breite

Dimensions for blade size of retractors

1st number = depth Example: 25 x 38 mm

2nd number = width

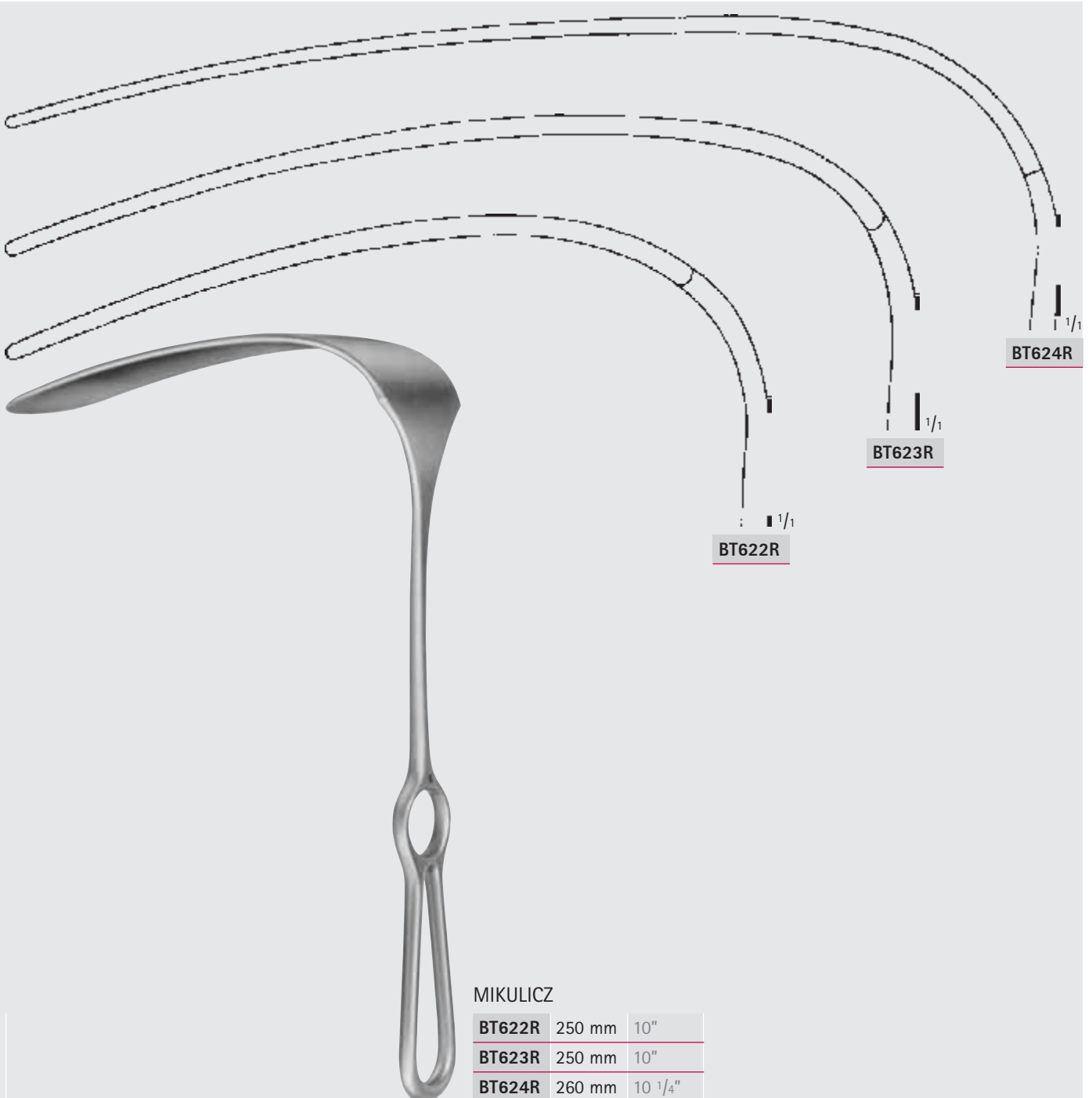
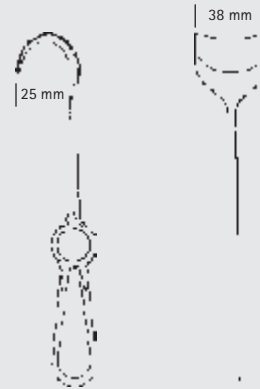

MIKULICZ

BT622R	250 mm	10"
BT623R	250 mm	10"
BT624R	260 mm	10 1/4"

BT



## Wundhaken – Wound Retractors

Wundhaken für Eingriffe in der Tiefe (Bauchdeckenhaken)  
Retractors for Deep Surgery (Abdominal Retractors)

BT

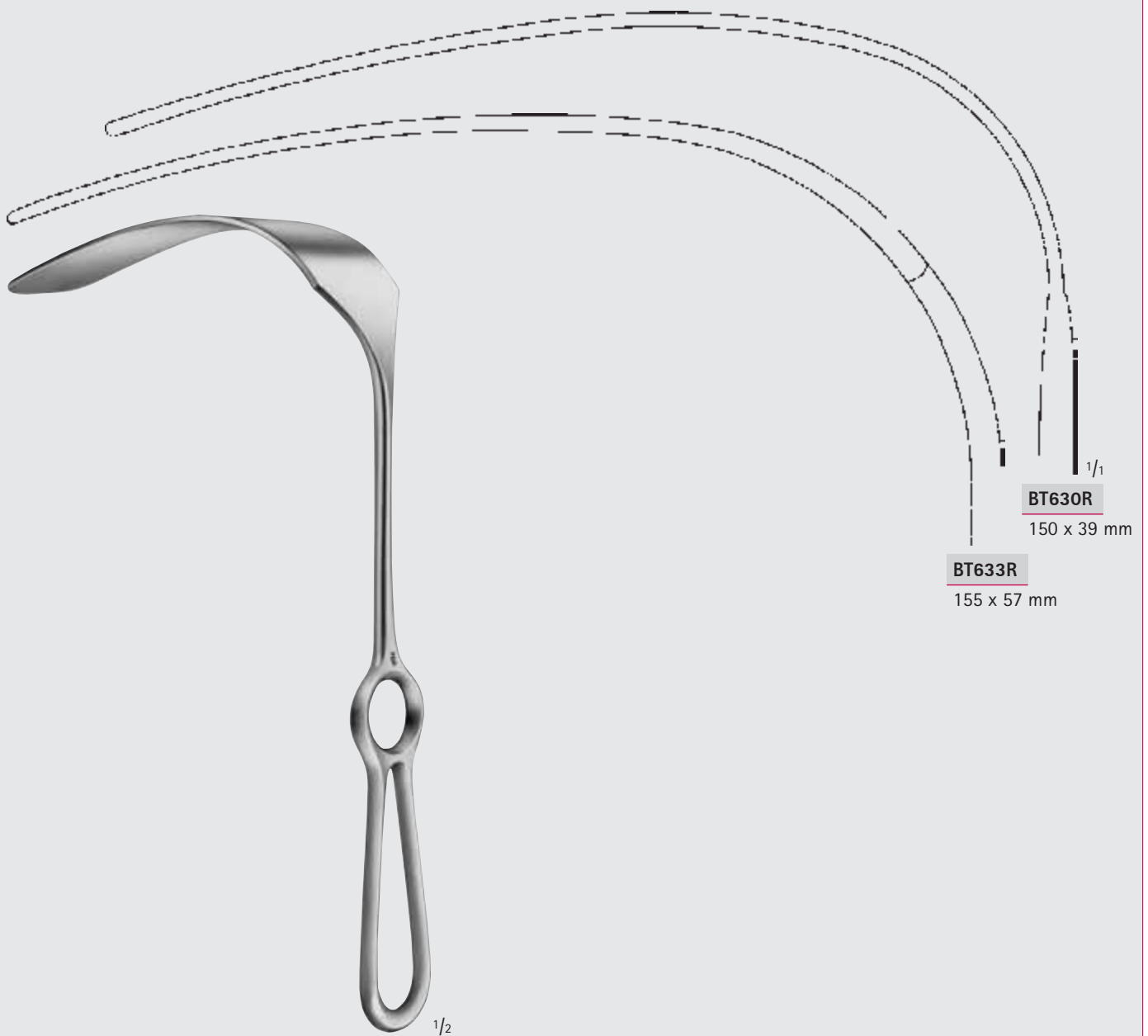

KELLY

**BT630R-BT633R**

260 mm, 10 1/4"

MILLIMETERS

# Wundhaken – Wound Retractors

Pelvishaken

Pelvis Retractors

BT

Maßangaben für Blattgrößen der Wundhaken

1. Zahl = Tiefe Beispiel: 25 x 38 mm

2. Zahl = Breite

Dimensions for blade size of retractors

1st number = depth Example: 25 x 38 mm

2nd number = width

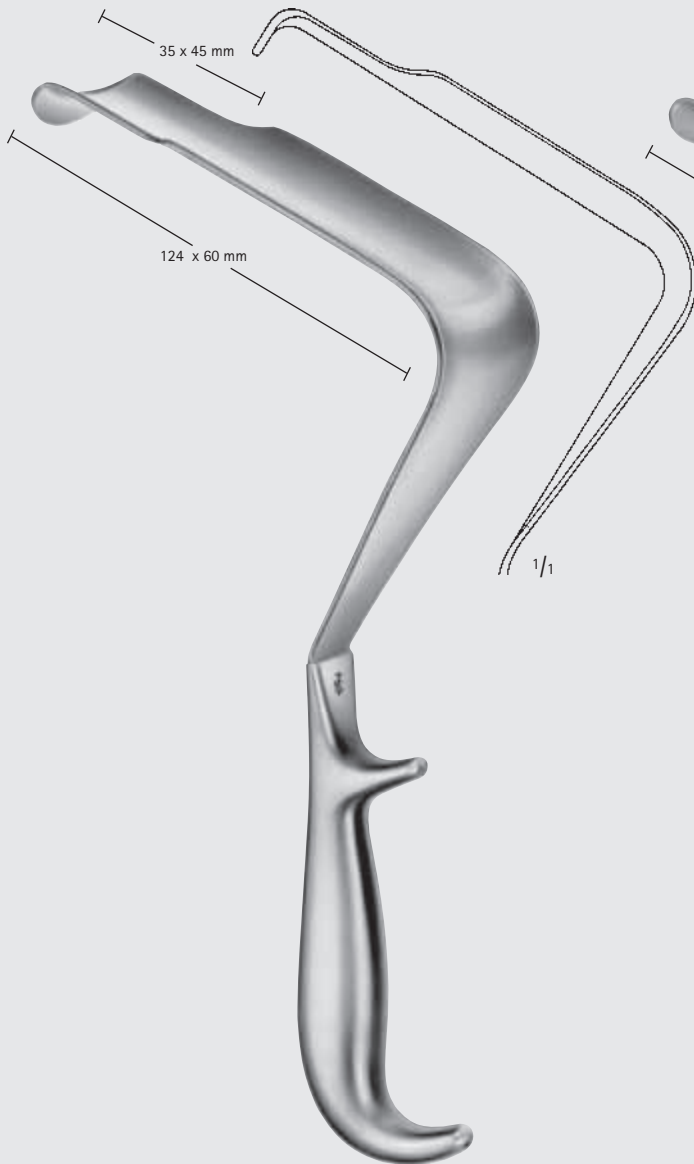
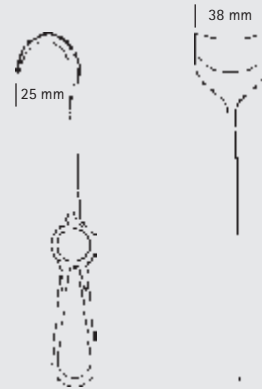

ST. MARKS

**BT670R**

290 mm, 11 1/2"

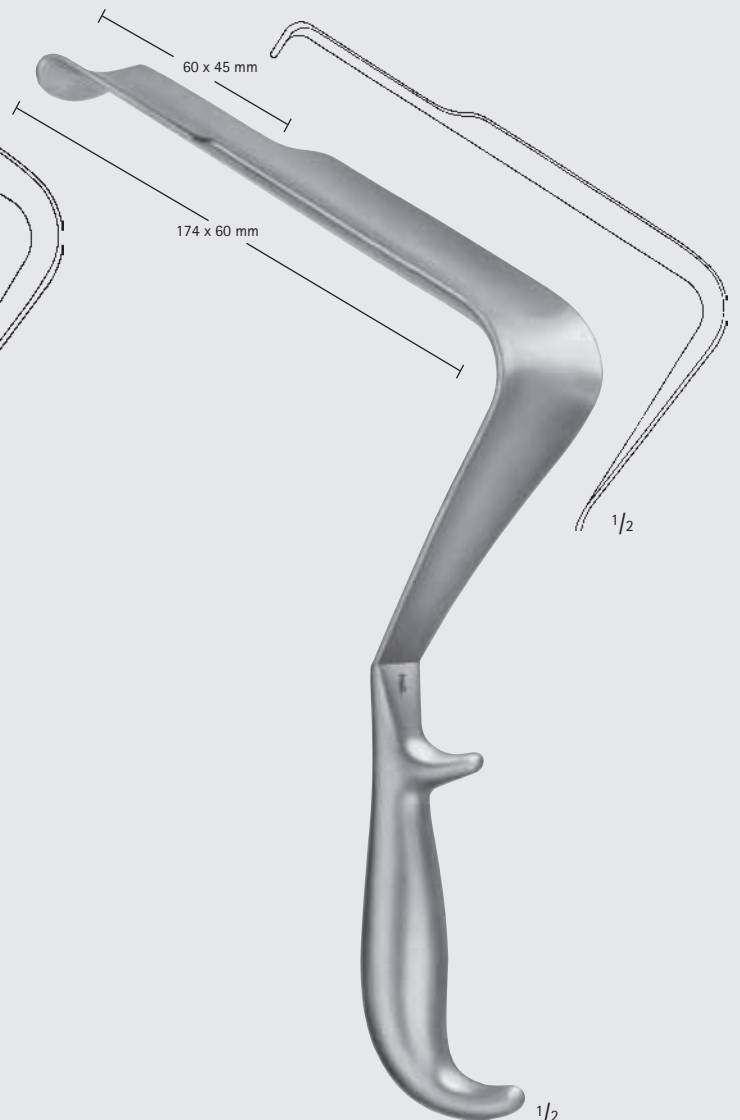

ST. MARKS

**BT672R**

330 mm, 13 1/8"



**Wundhaken – Wound Retractors**  
Pelvishaken  
Pelvis Retractors

**BT**

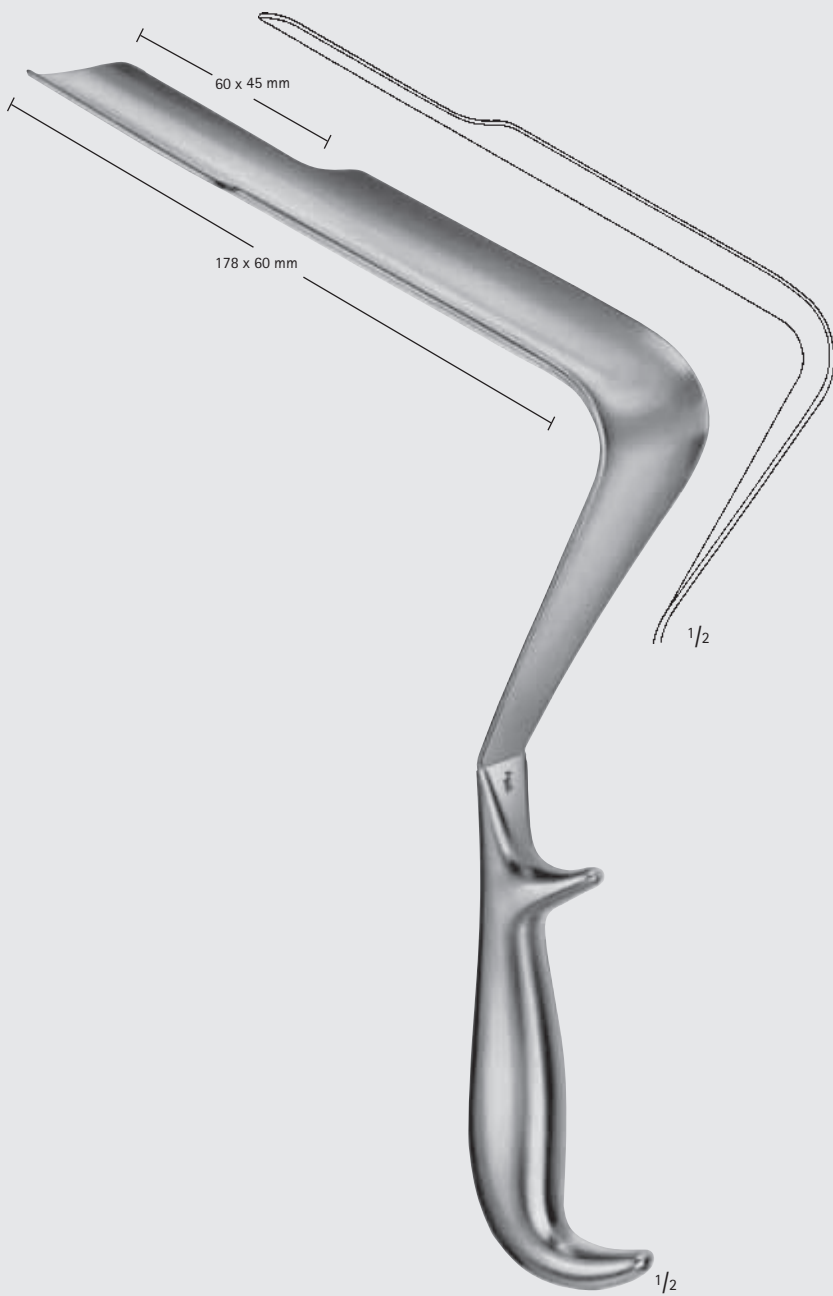

ST. MARKS

**BT674R**

330 mm, 13 1/8"

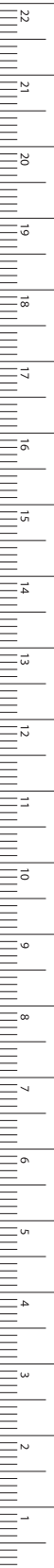

## Wundhaken – Wound Retractors

Wundhaken  
Retractors

Maßangaben für Blattgrößen der Wundhaken

1. Zahl = Tiefe                    Beispiel: 25 x 38 mm

2. Zahl = Breite

Dimensions for blade size of retractors

1st number = depth                Example: 25 x 38 mm

2nd number = width



38 mm



250 x 30 mm

MÜLLER

BT626R

270 mm, 10 3/4"

BT





## Wundhaken – Wound Retractors

Wundhaken, Bauchdeckenhaken  
Retractors, Abdominal Retractors

BT



TUDOR-EDWARDS

**BT500R**

205 mm, 8"

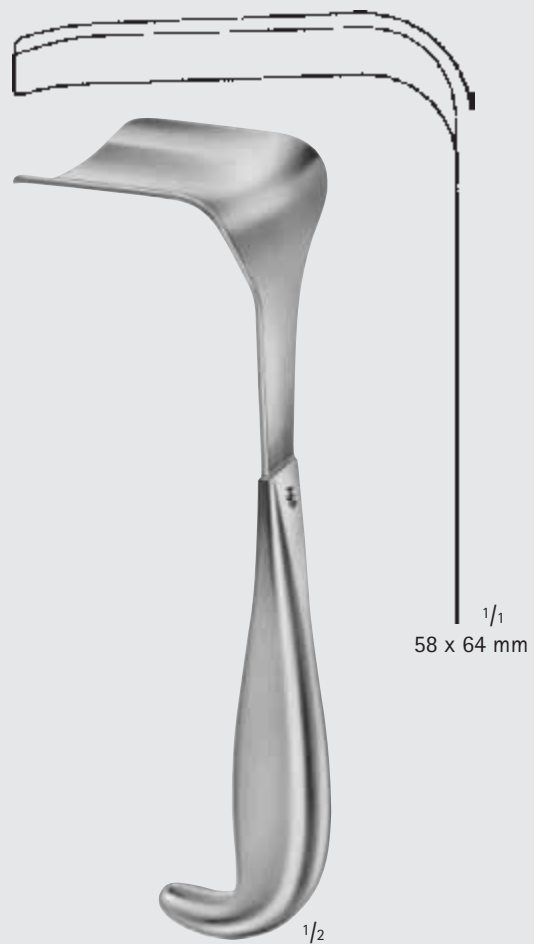

TUFFIER

**BT617R**

215 mm, 8 1/2"

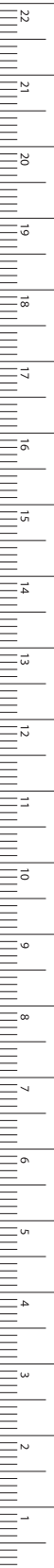

MILLIMETERS

## Wundhaken – Wound Retractors

Wundhaken, Bauchdeckenhaken

Retractors, Abdominal Retractors

Maßangaben für Blattgrößen der Wundhaken

1. Zahl = Tiefe Beispiel: 25 x 38 mm

2. Zahl = Breite

Dimensions for blade size of retractors

1st number = depth Example: 25 x 38 mm

2nd number = width

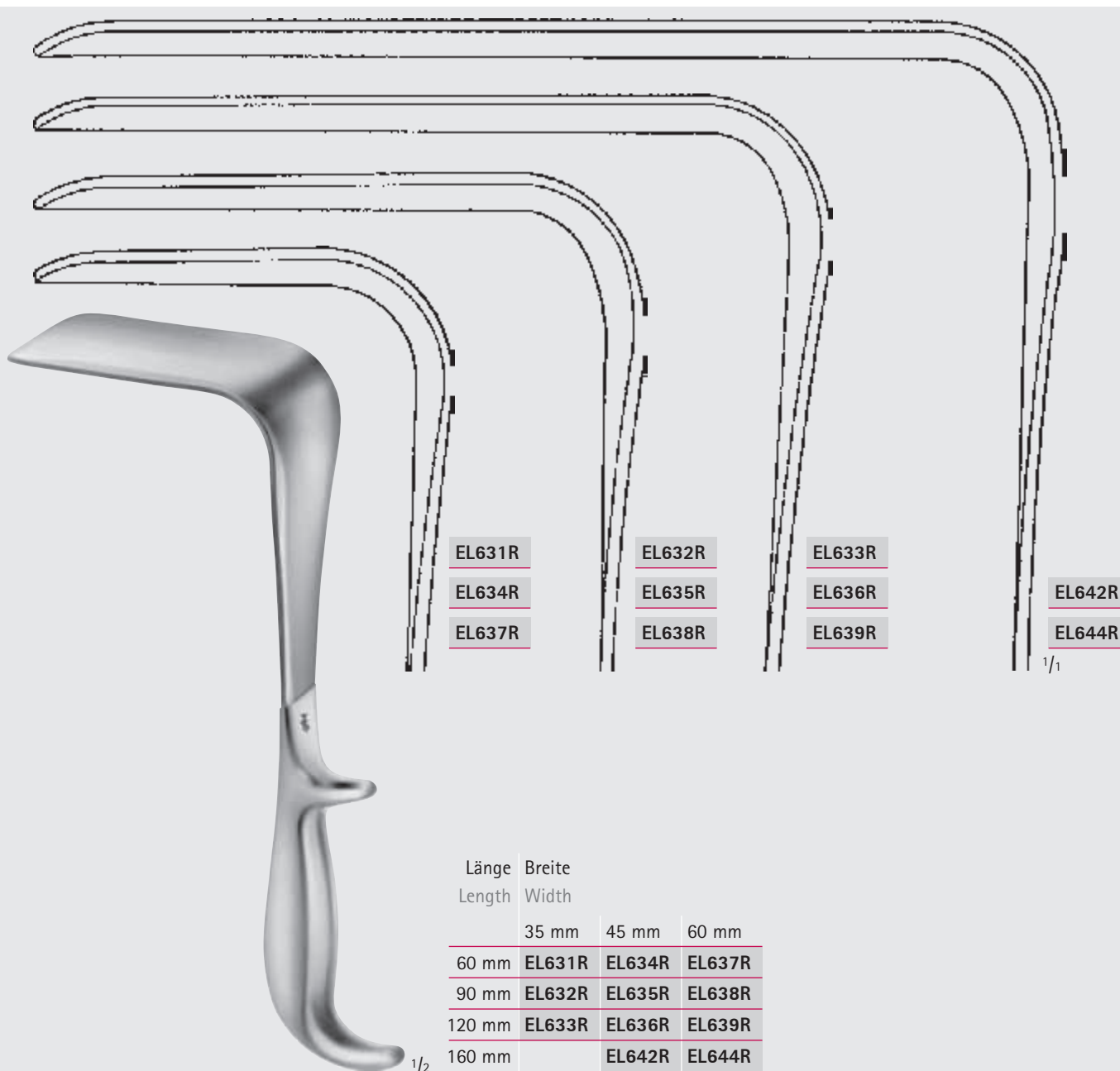
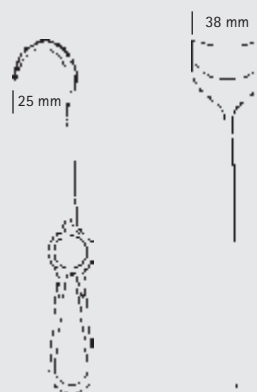

EL631R  
EL634R  
EL637R

EL632R  
EL635R  
EL638R

EL633R  
EL636R  
EL639R

EL642R  
EL644R

Länge Length	Breite Width			
	35 mm	45 mm	60 mm	
60 mm	EL631R	EL634R	EL637R	
90 mm	EL632R	EL635R	EL638R	
120 mm	EL633R	EL636R	EL639R	
160 mm		EL642R	EL644R	

DOYEN

EL631R-EL644R

240 mm, 9 1/2"

BT







**Wundhaken – Wound Retractors**  
 Wundhaken, Bauchdeckenhaken  
 Retractors, Abdominal Retractors

**BT**



**BT655R**

Fig. 1  
32 x 40 mm

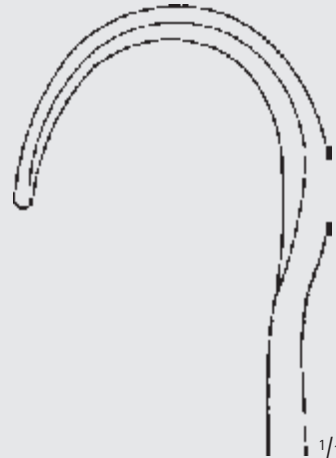

**BT656R**

Fig. 2  
34 x 50 mm

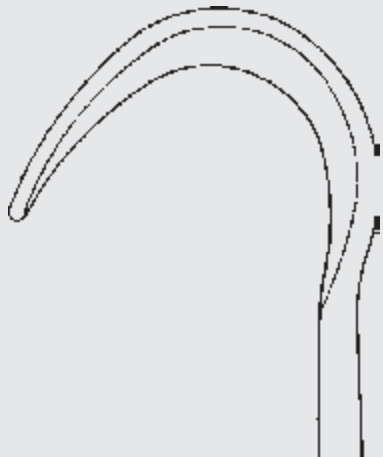

**BT657R**

Fig. 3  
41 x 60 mm

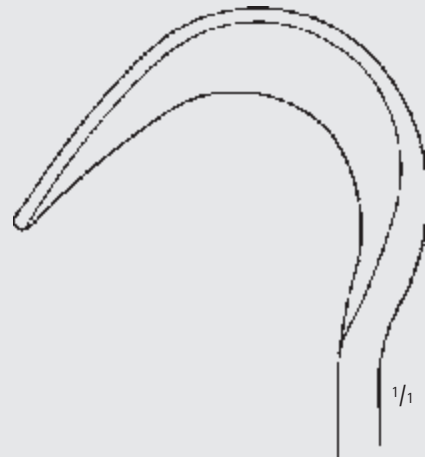

**BT658R**

Fig. 4  
46 x 75 mm



1/2

FRITSCH

**BT655R-BT659R**

235 mm, 9 1/4"

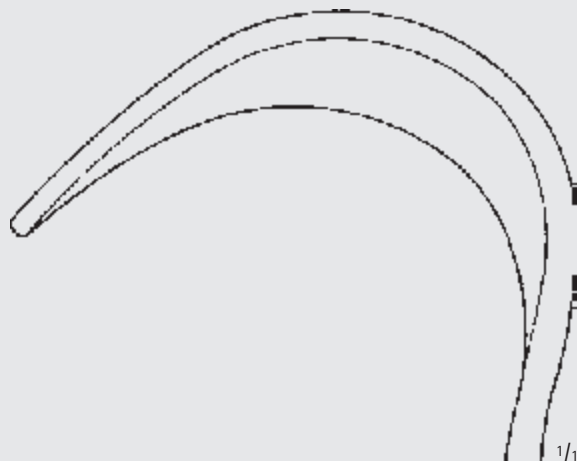

**BT659R**

Fig. 5  
64 x 85 mm

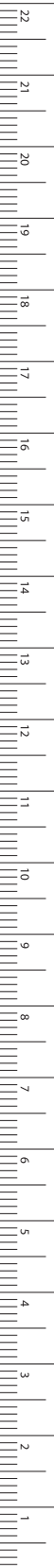

MILLIMETERS

## Wundhaken – Wound Retractors

Wundhaken, Bauchdeckenhaken

Retractors, Abdominal Retractors

Maßangaben für Blattgrößen der Wundhaken

1. Zahl = Tiefe Beispiel: 25 x 38 mm

2. Zahl = Breite

Dimensions for blade size of retractors

1st number = depth Example: 25 x 38 mm

2nd number = width

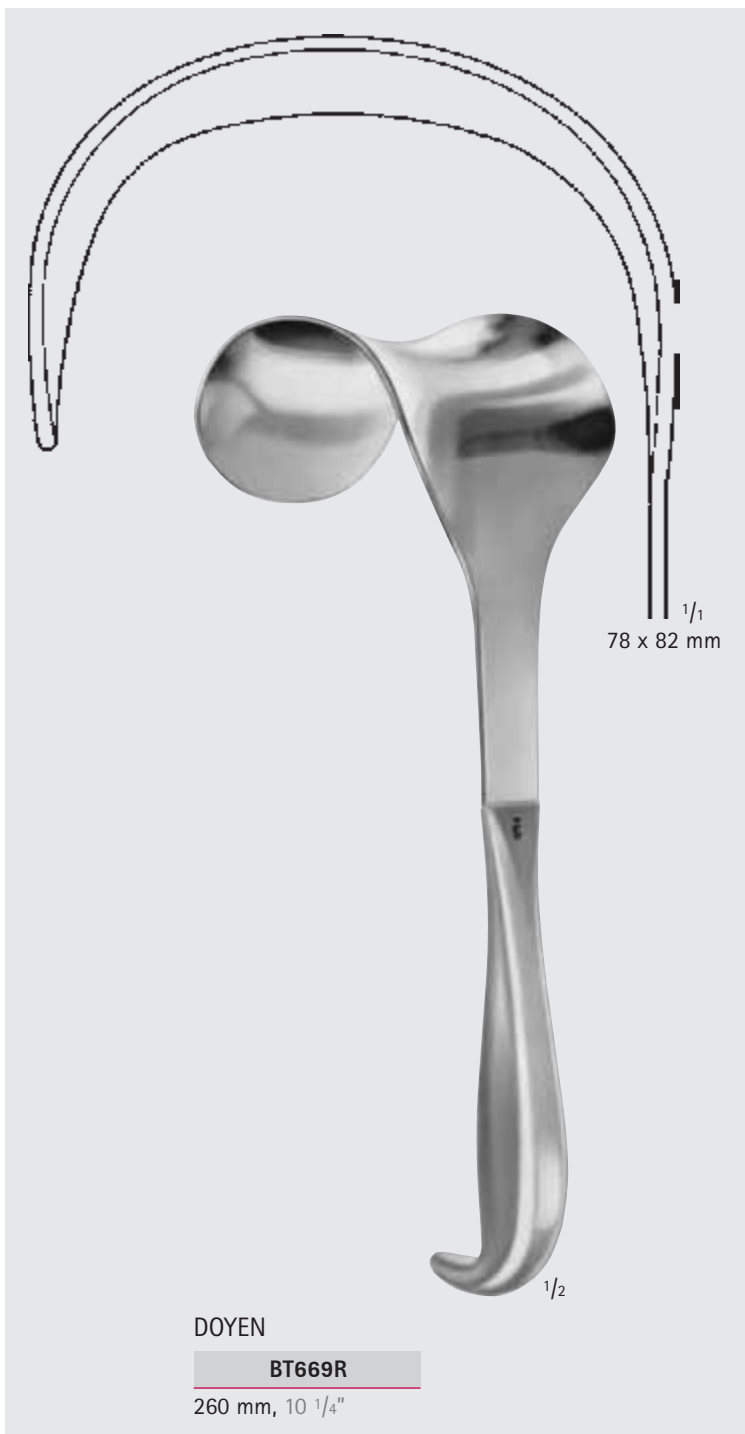
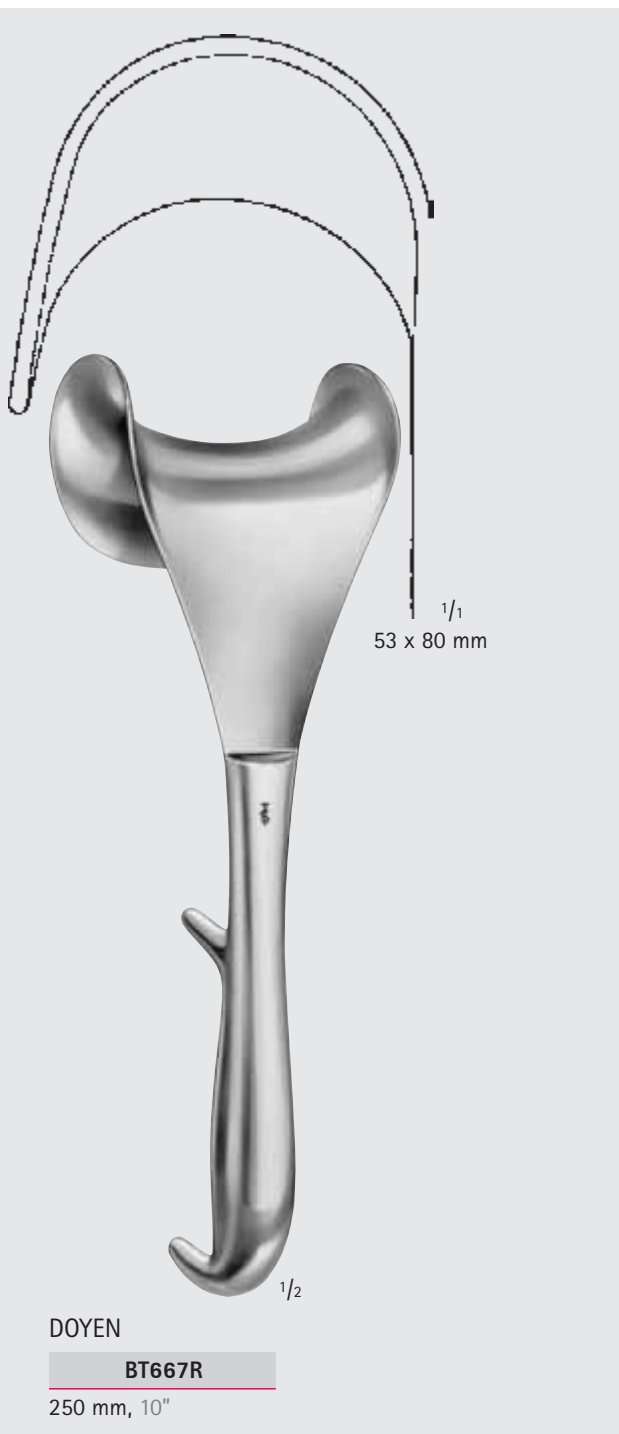
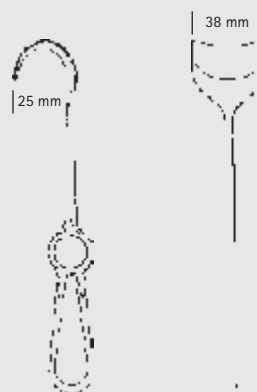



## Wundhaken – Wound Retractors

Bauchdeckenhaken  
Abdominal Retractors

BT



<sup>1</sup>/<sub>3</sub>

DOYEN

<b>BT721R</b>	48 x 90 mm
<b>BT723R</b>	48 x 105 mm
<b>BT724R</b>	48 x 120 mm
<b>BT725R</b>	48 x 135 mm

280 mm, 11"



**BT703R**

Kette (BT704R) mit Gewicht (EL747R/645 g)  
Chain (BT704R) with weight (EL747R/645 g)  
790 mm, 31"

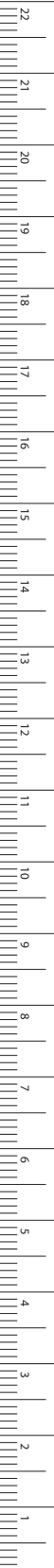

MILLIMETERS

## Wundhaken – Wound Retractors

Bauchdeckenhaken

Abdominal Retractors

BT



ROCHARD

<b>BT711R</b>	48 x 90 mm
<b>BT712R</b>	48 x 105 mm
<b>BT713R</b>	48 x 120 mm
<b>BT714R</b>	48 x 135 mm
<b>BT715R</b>	48 x 155 mm

310 mm, 12 1/4"

1/3

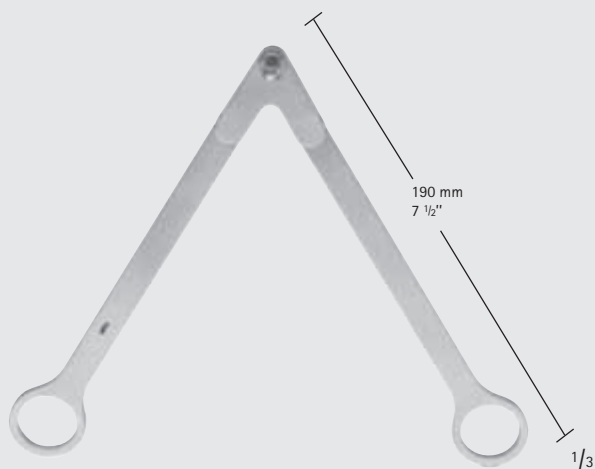

ROCHARD

**BT710R**

Fixiervorrichtung für  
BT711R - BT715R

Fixation device for  
BT711R - BT715R

190 mm, 8"

1/3



ROCHARD

**BT710R-BT711R**

1/3



## Wundhaken – Wound Retractors

### Bauchdeckenhaken Abdominal Retractors

BT

Befestigungsgestelle zu verwenden mit:  
BT710R Fixiervorrichtung und  
BT711R - BT715R ROCHARD Bauchdeckenhalter  
Mounting frames to be used with:  
BT710R Fixation device and  
BT711R - BT715R ROCHARD abdominal retractors

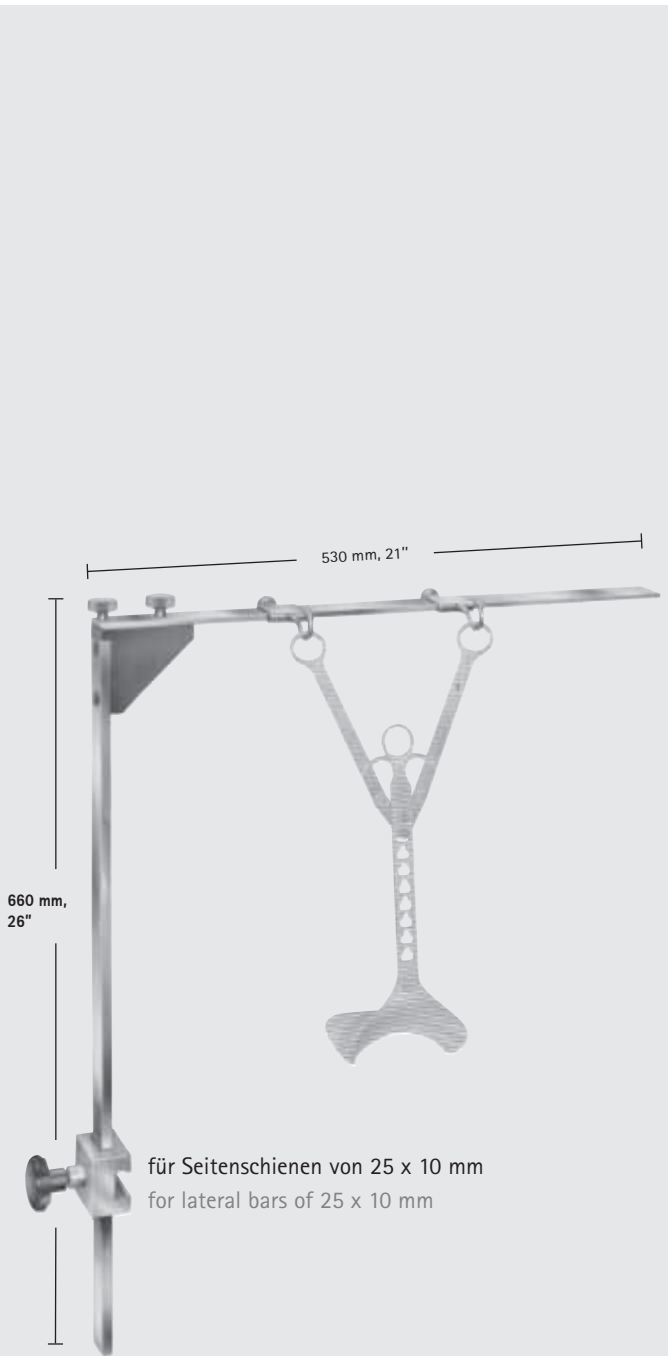

ROCHARD

**BT709R**

Befestigungsgestell zur Fixierung an den Seitenschienen der OP-Tische, zerlegbar zur Aufbereitung und Sterilisation.

Mounting frame for fastening to the lateral bars of the operating tables, can be dismantled for decontamination and sterilization.

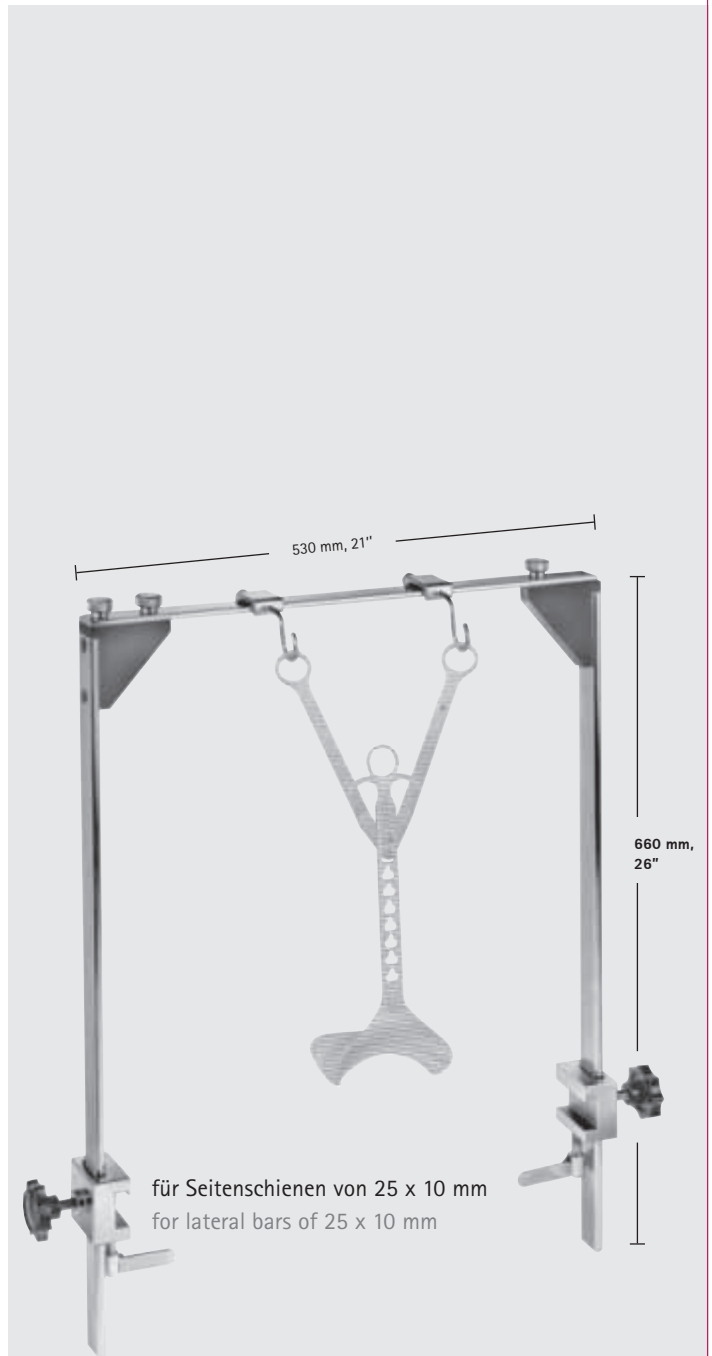

ROCHARD

**BT708R**

Befestigungsgestell mit beidseitiger Fixierung an den Seitenschienen der OP-Tische, dadurch mehr Stabilität, zur Aufbereitung und Sterilisation zerlegbar.

Mounting frame for fastening to both sides of the is given, can be dismantled for decontamination and sterilization.

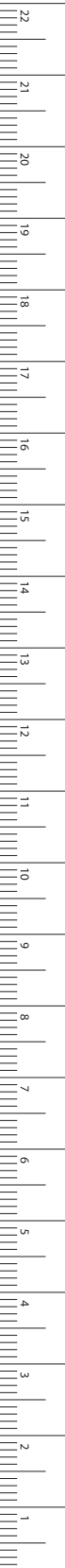

MILLIMETERS

## Wundhaken – Wound Retractors

Bauch- und Darmspatel

Abdominal and Intestinal Spatulas

BT



REVERDIN

**BT749R**

285 mm, 11 1/4"



HABERER

**BT758R**

biegsam  
malleable  
305 mm, 12"



RIBBON

<b>BT756R</b>	25 mm
<b>BT761R</b>	30 mm
<b>BT762R</b>	40 mm
<b>BT763R</b>	50 mm

biegsam  
malleable  
330 mm, 13 1/8"



TUFFIER

**BT750R**

biegsam  
malleable  
200 mm, 8"



<b>BT751R</b>	12 mm	200 mm	8"
<b>BT752R</b>	17 mm	200 mm	8"
<b>BT755R</b>	25 mm	250 mm	10"

biegsam  
malleable



## Wundhaken – Wound Retractors

### Bauch- und Darmspatel

### Abdominal- and Intestinal Spatulas

**BT**



KADER

**BT746R** 30 mm

**BT747R** 40 mm

270 mm, 10 3/4"

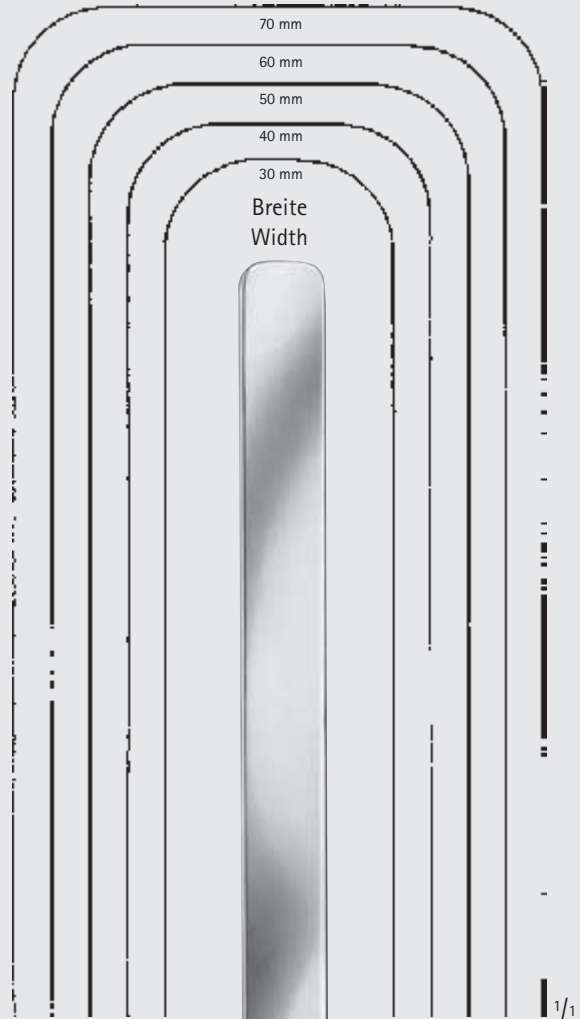

biegsam  
malleable

**BT773R** 30 mm

**BT774R** 40 mm

**BT775R** 50 mm

**BT776R** 60 mm

**BT777R** 70 mm

410 mm, 16"



## Wundhaken – Wound Retractors

Prostata- und Urethra-Retraktoren

Prostate- and Urethral Retractors

BT



1/2

**BT680R**

Prostata-Retraktor

Prostate retractor

360 mm, 14 3/8"



1/2

**BT681R**

Urethra-Retraktor

Urethral retractor

390 mm, 15 1/2"





**Wundhaken – Wound Retractors**  
Kropflöffel, Blutschöpfer  
Depressor, Blood Scoops

**BT**



**KOCHER**

**BT795R**

Kropflöffel  
Depressor, spoon shaped  
220 mm, 8 3/4"

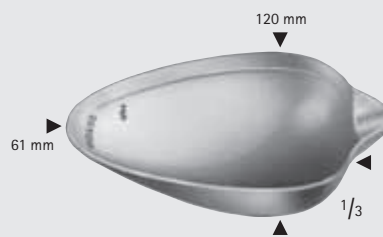

**BT780R**

Blutschöpfer, 50 ccm  
Blood scoop, 3 cu. inches

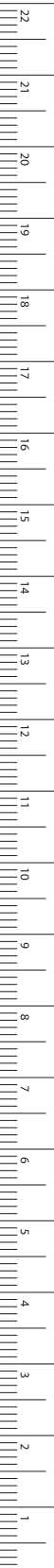



INCHES



**BV**



**Wundspreizer, Bauchdeckenhalter**  
Self-Retaining Retractors,  
Abdominal Retractors

# Wundspreizer, Bauchdeckenhalter – Self-Retaining Retractors, Abdominal Retractors

Wundspreizer

Self-Retaining Retractors

**BV**



BOSE

**FA001R**

60 mm, 2 3/8"



FINSEN

**BV001R**

50 mm, 2"



FINSEN

**BV002R**

70 mm, 2 3/4"



FINSEN MODIF.

**BV003R**

75 mm, 3"



FINSEN

**BV005R**

70 mm, 2 3/4"



**BV006R**

45 mm, 1 3/4"



**BV007R**

55 mm, 2 1/8"



# Wundspreizer, Bauchdeckenhalter – Self-Retaining Retractors, Abdominal Retractors

Wundspreizer  
Self-Retaining Retractors

BV

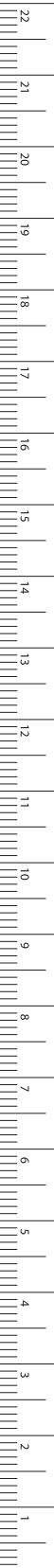

MILLIMETERS



1/2

PARSONNET

**BV014R**

50 mm, 2"



1/1

1/2

**BV008R**

stumpf  
blunt  
100 mm, 4"



1/1

1/2

**BV015R**

scharf  
sharp  
100 mm, 4"



1/2

ALM

**BV010R-BV011R**



BV010R	BV011R
70 mm	100 mm
2 3/4"	4"



1/1



1/2

LOGAN  
MODIF. REILL

**BV013R**

50 mm, 2"

# Wundspreizer, Bauchdeckenhalter – Self-Retaining Retractors, Abdominal Retractors

Wundspreizer, Lidsperrer

Self-Retaining Retractors, Lid Retractors

BV



ALLPORT

**BV028R**

95 mm, 3 3/4"

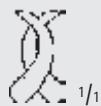

JANSEN

**BV030R**

100 mm, 4"

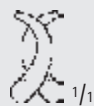

JANSEN

**BV032R**

100 mm, 4"



JANSEN

**BV033R**

100 mm, 4"



BARRAQUER

**OA200R**

45 mm, 1 3/4"



SAUER

**OA218R**

35 mm, 1 3/8"



LANCASTER

**OA225R**

80 mm, 3 1/8"



# Wundspreizer, Bauchdeckenhalter – Self-Retaining Retractors, Abdominal Retractors

Wundspreizer  
Self-Retaining Retractors

**BV**

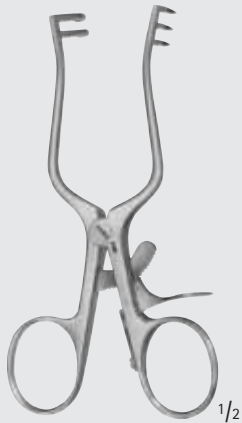

WEITLANER

**BV070R**

scharf

sharp

110 mm, 4 3/8"

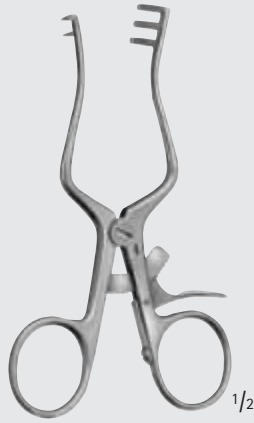
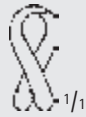

WEITLANER

**BV066R**

halbscharf

semi-sharp

110 mm, 4 3/8"

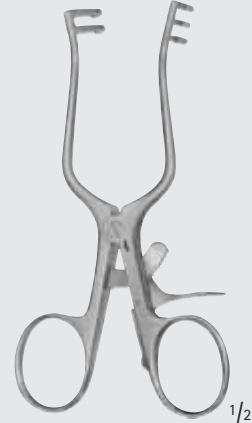
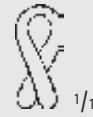

WEITLANER

**BV073R**

stumpf

blunt

110 mm, 4 3/8"



WEITLANER

**BV071R**

scharf

sharp

130 mm, 5 1/8"

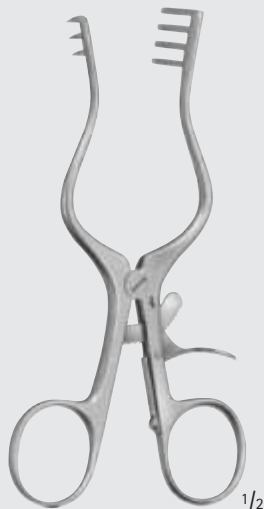

WEITLANER

**BV067R**

halbscharf

semi-sharp

130 mm, 5 1/8"



WEITLANER

**BV074R**

stumpf

blunt

130 mm, 5 1/8"

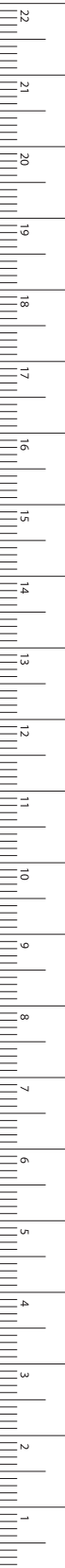

MILLIMETERS

# Wundspreizer, Bauchdeckenhalter – Self-Retaining Retractors, Abdominal Retractors

Wundspreizer

Self-Retaining Retractors

BV



WEITLANER

**BV101R**

scharf

sharp

130 mm, 5 1/8"

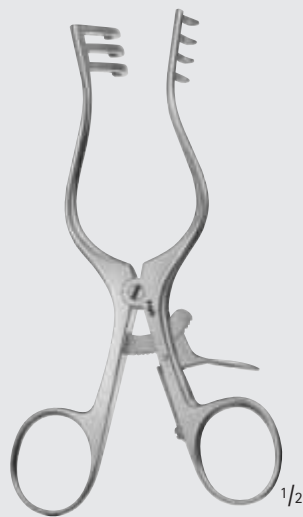

WEITLANER

**BV104R**

stumpf

blunt

130 mm, 5 1/8"

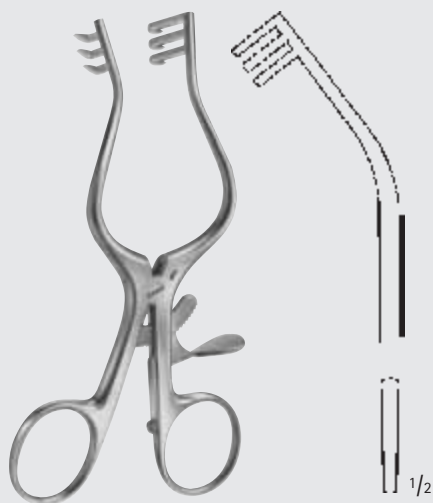
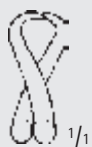

WULLSTEIN

**BV076R**

scharf

sharp

130 mm, 5 1/8"

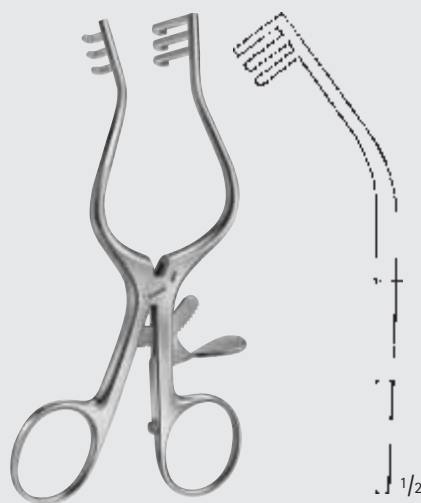

WULLSTEIN

**BV077R**

stumpf

blunt

130 mm, 5 1/8"







# Wundspreizer, Bauchdeckenhalter – Self-Retaining Retractors, Abdominal Retractors

Wundspreizer  
Self-Retaining Retractors

BV



WEITLANER

**BV072R**

scharf

sharp

165 mm, 6 1/2"



WEITLANER

**BV068R**

halbscharf

semi-sharp

165 mm, 6 1/2"



WEITLANER

**BV075R**

stumpf

blunt

165 mm, 6 1/2"



ALLENBERG

**BV097R**

Carotis-Sperrer komplett,  
bestehend aus:

BV098R Sperrer allein, stumpf

BV099R Mittelblatt allein,  
120 mm, 4 3/4"

Carotid retractor complete,  
consisting of:

BV098R Retractor only, blunt

BV099R Center blade only,  
120 mm, 4 3/4"

170 mm, 6 3/4"



MILLIMETERS

# Wundspreizer, Bauchdeckenhalter – Self-Retaining Retractors, Abdominal Retractors

Wundspreizer

Self-Retaining Retractors

BV



PLESTER

**BV090R**

stumpf

blunt

110 mm, 4 3/8"



PLESTER

**BV091R**

stumpf

blunt

110 mm, 4 3/8"

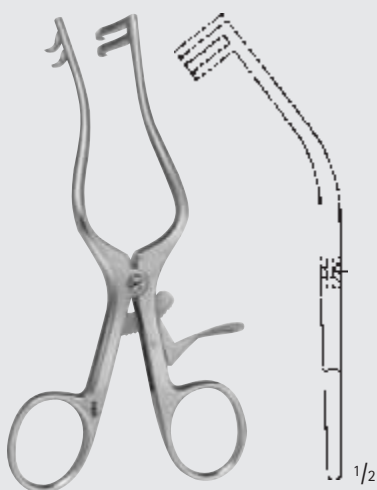

PLESTER

**BV078R**

scharf

sharp

130 mm, 5 1/8"

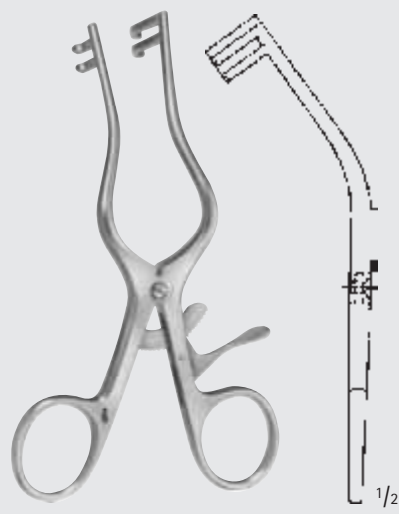
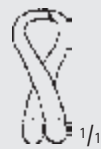

PLESTER

**BV079R**

stumpf

blunt

130 mm, 5 1/8"





# Wundspreizer, Bauchdeckenhalter – Self-Retaining Retractors, Abdominal Retractors

Wundspreizer  
Self-Retaining Retractors

BV

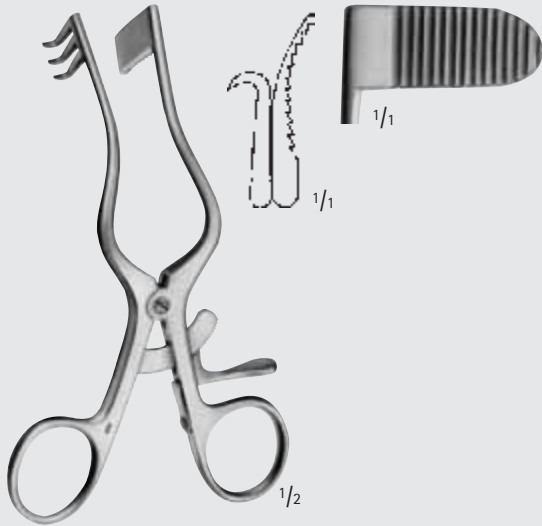

PERKINS

**OK794R**

130 mm, 5 1/8"

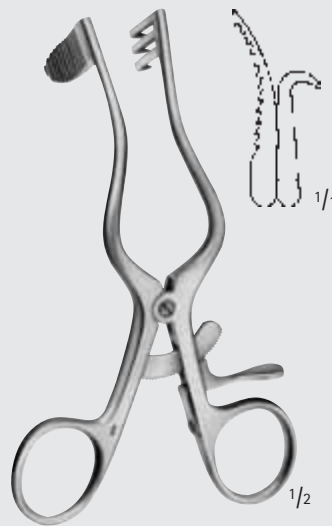

PERKINS

**OK795R**

130 mm, 5 1/8"



RNTNE HOSPITAL

**BV084R**

scharf

sharp

165 mm, 6 1/2"



ADSON-BABY

**BV085R** 140 mm 5 1/2"

**BV094R** 165 mm 6 1/2"

halbscharf

semi-sharp

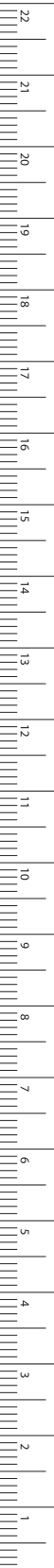

MILLIMETERS

# Wundspreizer, Bauchdeckenhalter – Self-Retaining Retractors, Abdominal Retractors

Wundspreizer

Self-Retaining Retractors

BV



1/2

JEFFERSON

**BV092R**

gebogen, stumpf

curved, blunt

140 mm, 5 1/2"



1/2

MOLLISON

**BV093R**

scharf

sharp

140 mm, 5 1/2"



1/2

MOLLISON

**BV088R**

scharf

sharp

155 mm, 6"



# Wundspreizer, Bauchdeckenhalter – Self-Retaining Retractors, Abdominal Retractors

Wundspreizer  
Self-Retaining Retractors

BV

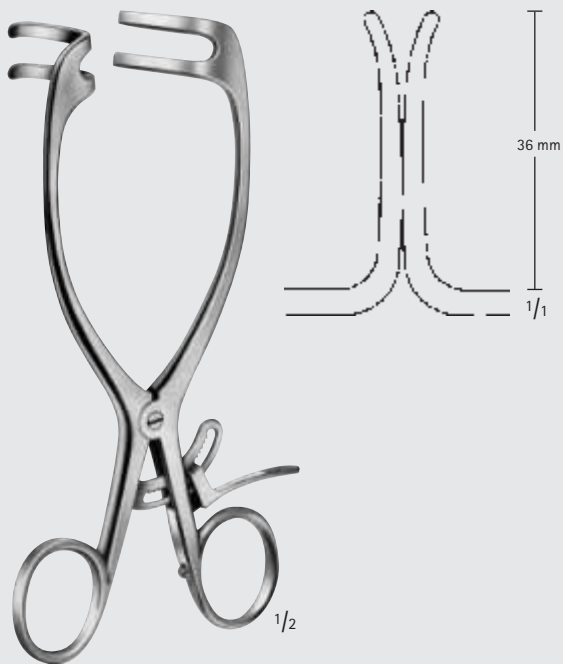

MAYO-ADAMS

**BV112R**

165 mm, 6 1/2"



HENDERSON

**BV113R**

scharf

sharp

180 mm, 7"

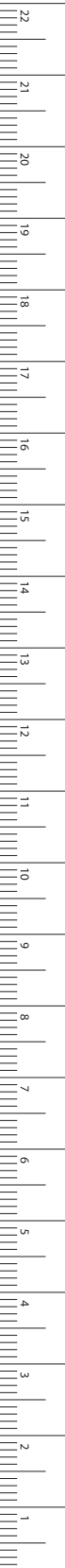

MILLIMETERS

# Wundspreizer, Bauchdeckenhalter – Self-Retaining Retractors, Abdominal Retractors

Wundspreizer

Self-Retaining Retractors

BV

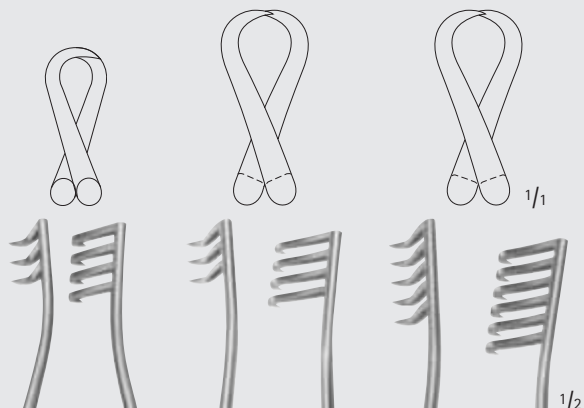

**BV200R**

scharf  
sharp  
195 mm  
7 3/4"

**BV206R**

scharf  
sharp  
240 mm  
9 1/2"

**BV208R**

scharf  
sharp  
255 mm  
10"

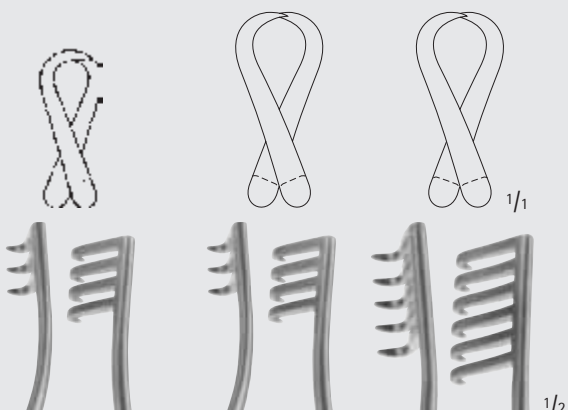

**BV199R**

halbscharf  
semi-sharp  
195 mm  
7 3/4"

**BV203R**

halbscharf  
semi-sharp  
240 mm  
9 1/2"

**BV205R**

halbscharf  
semi-sharp  
255 mm  
10"

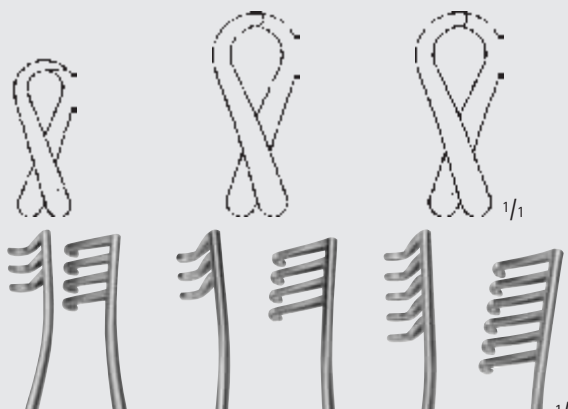

**BV201R**

stumpf  
blunt  
195 mm  
7 3/4"

**BV207R**

stumpf  
blunt  
240 mm  
9 1/2"

**BV209R**

stumpf  
blunt  
255 mm  
10"



**WEITLANER**

**BV199R-BV209R**



## Wundspreizer, Bauchdeckenhalter – Self-Retaining Retractors, Abdominal Retractors

Wundspreizer  
Self-Retaining Retractors

BV



IRWIN

**BV247R**

scharf  
sharp  
175 mm, 7"



TRAVERS

**BV249R**

stumpf  
blunt  
215 mm, 8"

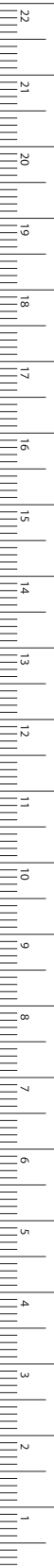

MILLIMETERS

# Wundspreizer, Bauchdeckenhalter – Self-Retaining Retractors, Abdominal Retractors

Laminektomie-Wundspreizer

Self-Retaining Laminectomy Retractors

BV



ANDERSON-ADSON

**BV250R**

scharf

sharp

190 mm, 7 1/2"



NORFOLK AND NORWICH

**BV248R**

stumpf

blunt

220 mm, 8 3/4"

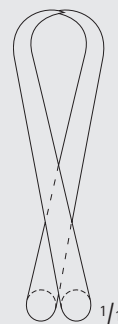

ADSON

**BV252R**

scharf

sharp

265 mm, 10 1/2"





# Wundspreizer, Bauchdeckenhalter – Self-Retaining Retractors, Abdominal Retractors

Laminektomie-Wundspreizer

Self-Retaining Laminectomy Retractors

BV

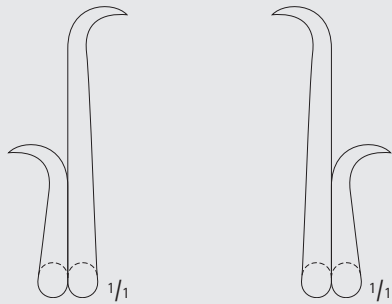

**BV255R**



CONE

**BV260R**

scharf

sharp

265 mm, 10 1/2"

**BV254R-BV255R**

Hemilaminektomiespreizer

scharf

Hemi-laminectomy retractor

sharp

280 mm, 11"

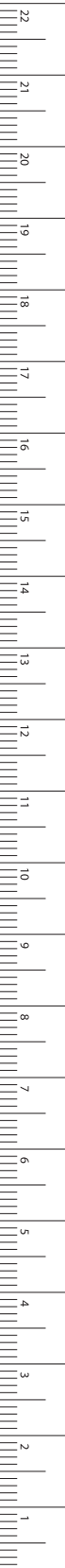

MILLIMETERS

# Wundspreizer, Bauchdeckenhalter – Self-Retaining Retractors, Abdominal Retractors

Laminektomie-Wundspreizer

Self-Retaining Laminectomy Retractors

BV

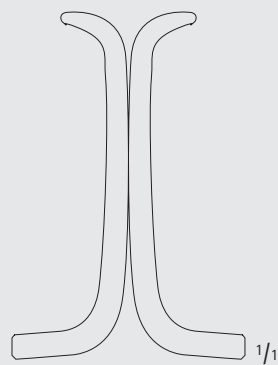

BECKMANN-ADSON

BECKMANN-ADSON

**BV271R**

**BV272R**

halbscharf

scharf

semi-sharp

sharp

310 mm, 12"

310 mm, 12"

HARVEY-JACKSON

**BV258R**

scharf

sharp

280 mm, 11"



## Wundspreizer, Bauchdeckenhalter – Self-Retaining Retractors, Abdominal Retractors

Laminektomie-Wundspreizer

Self-Retaining Laminectomy Retractors

**BV**



ADSON

**BV273R**

halbscharf

semi-sharp

320 mm, 12 3/4"

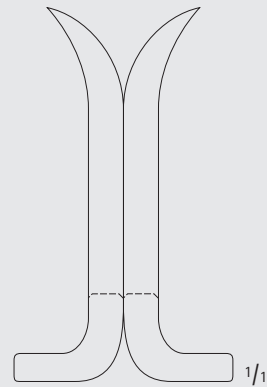

BECKMANN-EATON

**BV276R**

scharf

sharp

320 mm, 12 3/4"

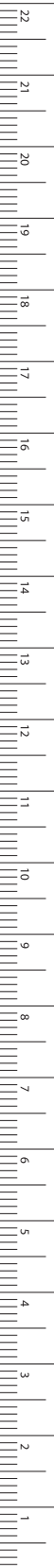

MILLIMETERS

# Wundspreizer, Bauchdeckenhalter – Self-Retaining Retractors, Abdominal Retractors

Spezialwundspreizer

Special Retractors

BV

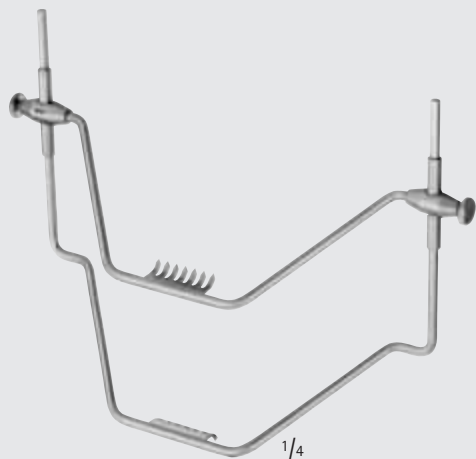
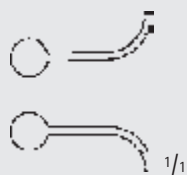

**BV086R**

Strumaspreizer  
Thyroid retractor



JOLL (FRIEDMANN)

**BV087R**

Thyreoid- und Vulva-Spreizer  
Thyroid- and vaginal retractor  
155 mm, 6"

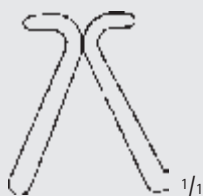

JACKSON-BURROWS

**BV993R**

Wundspreizer, stumpf  
Retractor, blunt  
185 mm, 7 1/4"





# Wundspreizer, Bauchdeckenhalter – Self-Retaining Retractors, Abdominal Retractors

Spezialwundspreizer  
Special Retractors

**BV**



GELPI

**BV996R**

Vulva-Spreizer  
Vaginal retractor  
135 mm, 5 1/4"



GELPI

**BV997R**

Haut- und Vulva-Spreizer  
Skin- and vaginal retractor  
175 mm, 7"

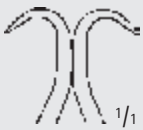

DE BAKEY

**BV998R**

Femur-Wundspreizer für Kinder  
Femur retractor for children  
100 mm, 4"



DE BAKEY

**BV999R**

Femur-Wundspreizer  
Femur retractor  
145 mm, 5 3/4"

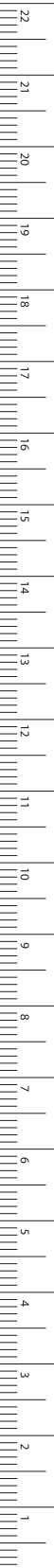

MILLIMETERS

# Wundspreizer, Bauchdeckenhalter – Self-Retaining Retractors, Abdominal Retractors

Trachealdilatatoren

Tracheal Dilators

BV

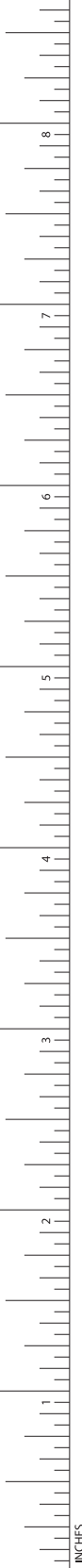

TROUSSEAU

**FA005R**

120 mm, 4 3/4"

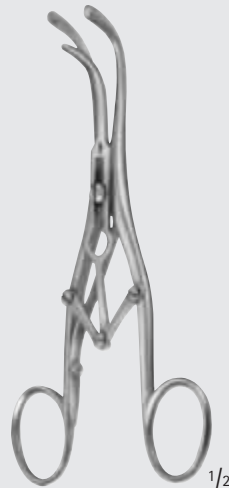

LABORDE

**FA006R**

125 mm, 5"



LABORDE

**FA007R**

kräftiges Modell  
strong pattern

135 mm, 5 1/4"



## Wundspreizer, Bauchdeckenhalter – Self-Retaining Retractors, Abdominal Retractors

Iliaca-Sperrer  
Iliaca Retractor

BV



**BV712T**  
30 x 30 mm



**BV713T**  
90 x 60 mm



**BV709R**  
Pinzette zum  
Valvenwechsel  
Forceps for changing  
the blades  
130 mm, 5 1/8

### ALLENBERG

#### **BV710R**

Iliaca-Sperrer komplett,  
bestehend aus:

- BV711R Sperrer allein
- BV712T Retraktorblatt lateral
- BV713T Retraktorblatt medial

Iliac retractor complete,  
consisting of:

- BV711R Retractor only
- BV712T Retractor blade lateral
- BV713T Retractor blade medial

Sperrersystem zur idealen Darstellung der Arteria iliaca communis. Die Retraktorblätter sind aus Titan gefertigt und sind dadurch röntgentransparent. Das große mediale Retraktorblatt kann intraoperativ stufenweise verstellt werden. Das Sperrersystem kann aufgrund der einfachen Auswechselbarkeit der Valven links- sowie rechtseitig eingesetzt werden.

Retractor system for optimal approach to the arteria iliaca communis. The retractor blades are made out of titanium and therefore they are radiotransparent. The big medial retractor blade can be gradually adjusted during the operation. Because of the blades which are easy to exchange the retractor system can be used for the left and the right side.

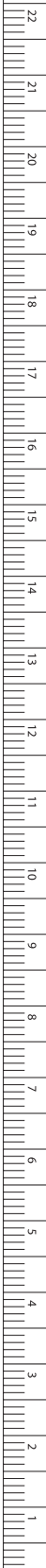

MILLIMETERS

## Wundspreizer, Bauchdeckenhalter – Self-Retaining Retractors, Abdominal Retractors

Wundspreizer für Laminektomie und andere Applikationen

Self-Retaining Retractors for Laminectomy and Other Applications

BV

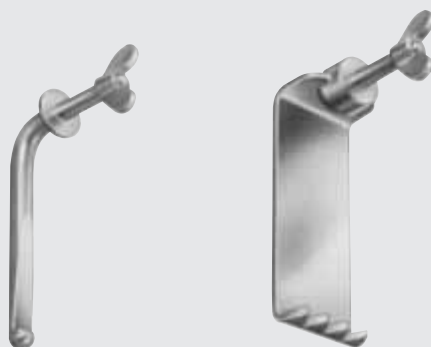

SCOVILLE

**BV403R**

55 mm

SCOVILLE

**BV405R**

63 x 25 mm

**BV406R**

63 x 51 mm

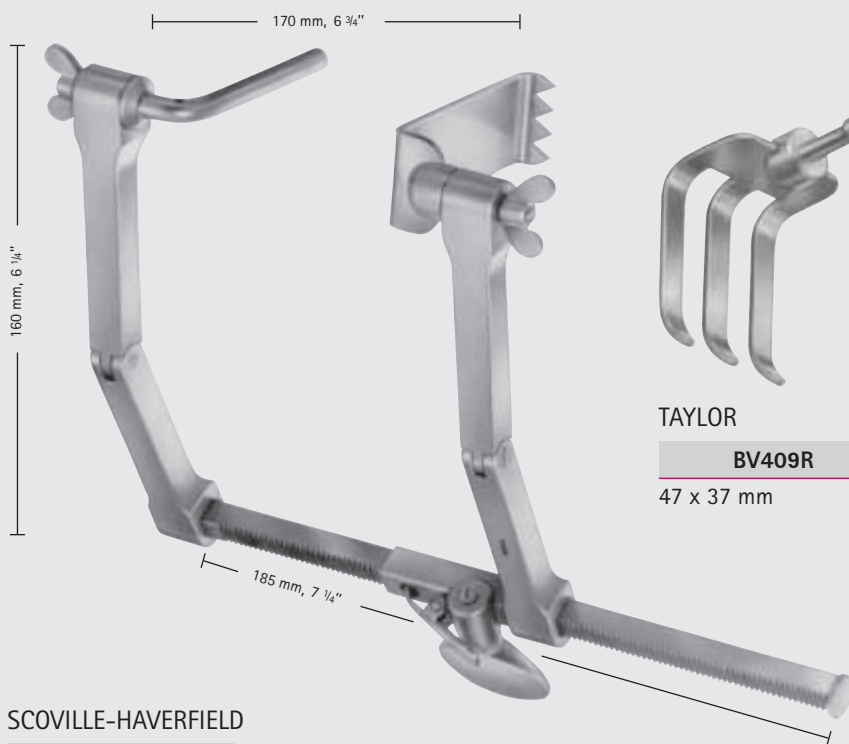

TAYLOR

**BV409R**

47 x 37 mm

TAYLOR

**BV411R**

62 x 52 mm

SCOVILLE-HAVERFIELD

**BV400R**

Sperrer komplett,  
bestehend aus:

- BV401R Rahmen allein
- BV403R Haken
- BV405R Blatt

Retractor complete,  
consisting of:

- BV401R Frame only
- BV403R Hook
- BV405R Blade





## Wundspreizer, Bauchdeckenhalter – Self-Retaining Retractors, Abdominal Retractors

Wundspreizer für Laminektomie und andere Applikationen  
Self-Retaining Retractors for Laminectomy and Other Applications



### Aesculap Kugelschnellverschluss an Sperrern und Blättern

Vorteile:

- ⌘ Sicheres Arretieren der Blätter ohne zusätzliche Verriegelung.
- ⌘ Verhindert Herausfallen der Blätter aus den Sperrern, auch beim Anreichen.
- ⌘ Glatte Oberfläche, dadurch können Ligaturfäden nicht hängenbleiben.
- ⌘ Schnelles, problemloses Auswechseln der Blätter, auch intraoperativ.
- ⌘ Universelle Kombinationsmöglichkeiten der verschiedenen Sperrmodelle untereinander.
- ⌘ Dadurch optimale Auswahl der Blattgrößen entsprechend den jeweiligen operativen Erfordernissen.

### Aesculap ball snap system on spreaders and blades

Advantages:

- ⌘ Without additional fixation blades are safely locked
- ⌘ and can therefore not fall off the retractor shanks even the instrument is passed on to the surgeon
- ⌘ no risk of catching suture due to smooth surface
- ⌘ Without any trouble blades can be quickly exchanged also during the operation
- ⌘ Different retractors patterns can be universally combined and exchanged at random, which allows
- ⌘ optimum selection of the blade size according to surgical needs.

BV

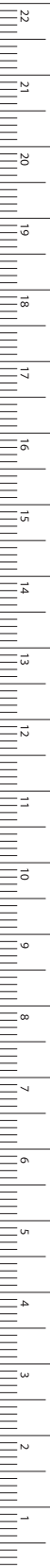

### KUGELSCHNELLVERSCHLUSS BALL SNAP CLOSURE

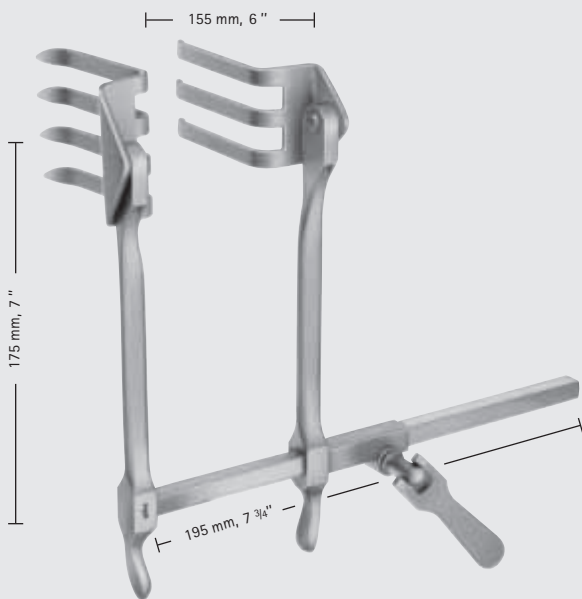

### SCOVILLE-RICHTER

#### BV510R

Sperrer komplett,  
umlegbares Modell  
bestehend aus:

BV509R Sperrer allein  
BV516R Blätter (Paar)

Kann in angelegtem Zustand zum Tücherwechsel  
usw. auf die andere Seite umgelegt werden.

Retractor complete,  
reversible type  
consisting of:

BV509R Retractor only  
BV516R Blades (pair)

The retractor bar and shanks may be easily rotated  
180° when blades are in situ.



#### BV516R

62 x 52 mm  
PAA = Paar

62 x 37 mm

#### BV517R

47 x 51 mm

PAA = Pair



#### BV518R

30 x 40 mm



#### BV519R

37 x 62 mm

MILLIMETERS

# Wundspreizer, Bauchdeckenhalter – Self-Retaining Retractors, Abdominal Retractors

Wundspreizer für die Wirbelsäule  
Self-Retaining Retractors for Spine

 KUGELSCHNELLVERSCHLUSS MIT VERDREHSICHERUNG  
BALL SNAP CLOSURE WITH TORRSION LOCK

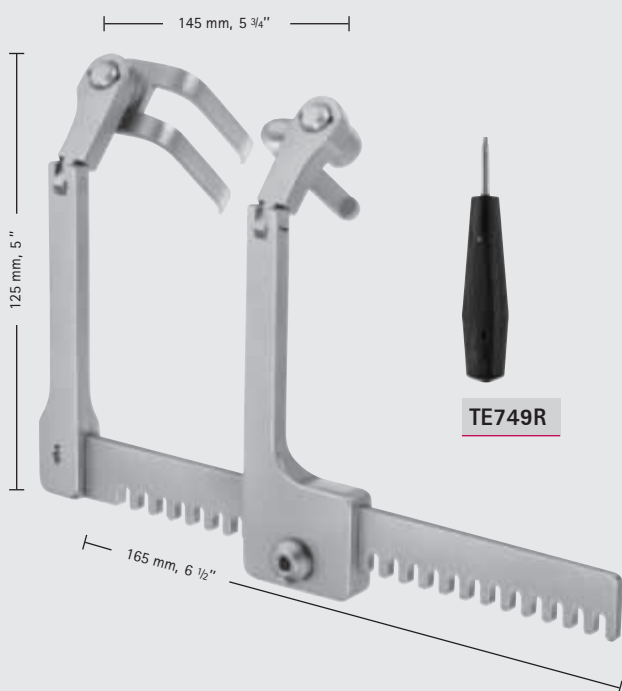

**TE749R**



**BV435R**

Haken  
Hook  
38 mm



**BV437R**

Haken  
Hook  
58 mm



Blätter  
Blades

<b>BV441R</b>	32 x 22 mm
<b>BV442R</b>	37 x 22 mm
<b>BV443R</b>	42 x 22 mm
<b>BV444R</b>	47 x 22 mm
<b>BV445R</b>	52 x 22 mm
<b>BV446R</b>	57 x 22 mm
<b>BV447R</b>	62 x 22 mm
<b>BV448R</b>	67 x 22 mm

## CASPAR

### **BV450R**

Sperrer komplett,  
für Laminektomie und Hemi-Laminektomie,  
lumbal, thorakal und cervical einzusetzen  
bestehend aus:

- BV449R Sperrer allein, mit Drehschlüssel TE749R
- BV435R Haken
- BV442R Blatt
- BV443R Blatt
- BV444R Blatt
- BV445R Blatt
- BV446R Blatt

Retractor complete,  
for laminectomy and hemi-laminectomy,  
lumbar, thoracic and cervical available  
consisting of:

- BV449R Retractor only, with key TE749R
- BV435R Hook
- BV442R Blade
- BV443R Blade
- BV444R Blade
- BV445R Blade
- BV446R Blade



Blätter  
Blades

<b>BV451R</b>	32 x 37 mm
<b>BV452R</b>	37 x 37 mm
<b>BV453R</b>	42 x 37 mm
<b>BV454R</b>	47 x 37 mm
<b>BV455R</b>	52 x 37 mm
<b>BV456R</b>	57 x 37 mm
<b>BV457R</b>	62 x 37 mm
<b>BV458R</b>	67 x 37 mm



Blätter  
Blades

<b>BV461R</b>	32 x 52 mm
<b>BV462R</b>	37 x 52 mm
<b>BV463R</b>	42 x 52 mm
<b>BV464R</b>	47 x 52 mm
<b>BV465R</b>	52 x 52 mm
<b>BV466R</b>	57 x 52 mm
<b>BV467R</b>	62 x 52 mm
<b>BV468R</b>	67 x 52 mm



## Wundspreizer, Bauchdeckenhalter – Self-Retaining Retractors, Abdominal Retractors

Universal-Wirbelsäulensperrer

Universal Retractor System

### Universal-Wirbelsäulensperrer

Der selbsthaltende CASPAR-Universal-Wirbelsäulensperrer ermöglicht eine sichere Retraction und spart durch seine abnehmbaren Griffe Platz im OP-Feld.

### Universal Spinal Retractor System

The self-retaining CASPAR universal spinal retractor permits safe retraction and saves space in the operation area due to the removable handles.

BV

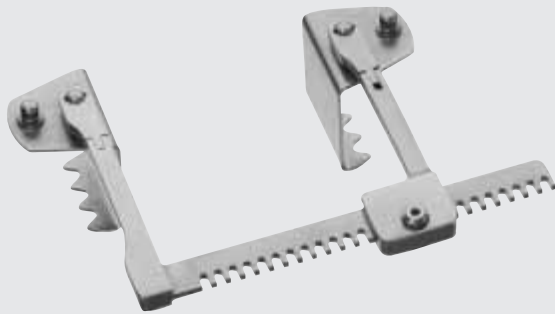

CASPAR

**BV449R**

Sperrer ohne Blätter

Retractor without blades



Blätter  
Blades

**BV413R**

Handgriff

Handle

**BV414R** 50 x 44 mm

**BV415R** 50 x 54 mm

**BV416R** 50 x 74 mm

**BV417R** 50 x 89 mm

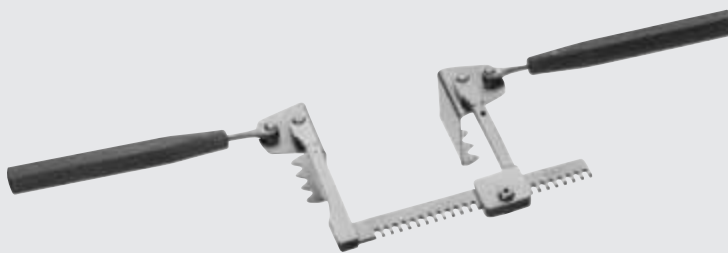

**TE749R**

Drehschlüssel

Key for socket-head screw

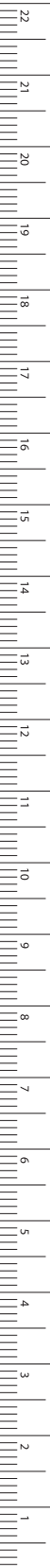

MILLIMETERS

# Wundspreizer, Bauchdeckenhalter – Self-Retaining Retractors, Abdominal Retractors

Wundspreizer für cervicale Wirbelsäule

Retractors for Cervical Spine



KUGELSCHNELLVERSCHLUSS MIT VERDREHSICHERUNG  
BALL SNAP CLOSURE WITH TORRSION LOCK

BV

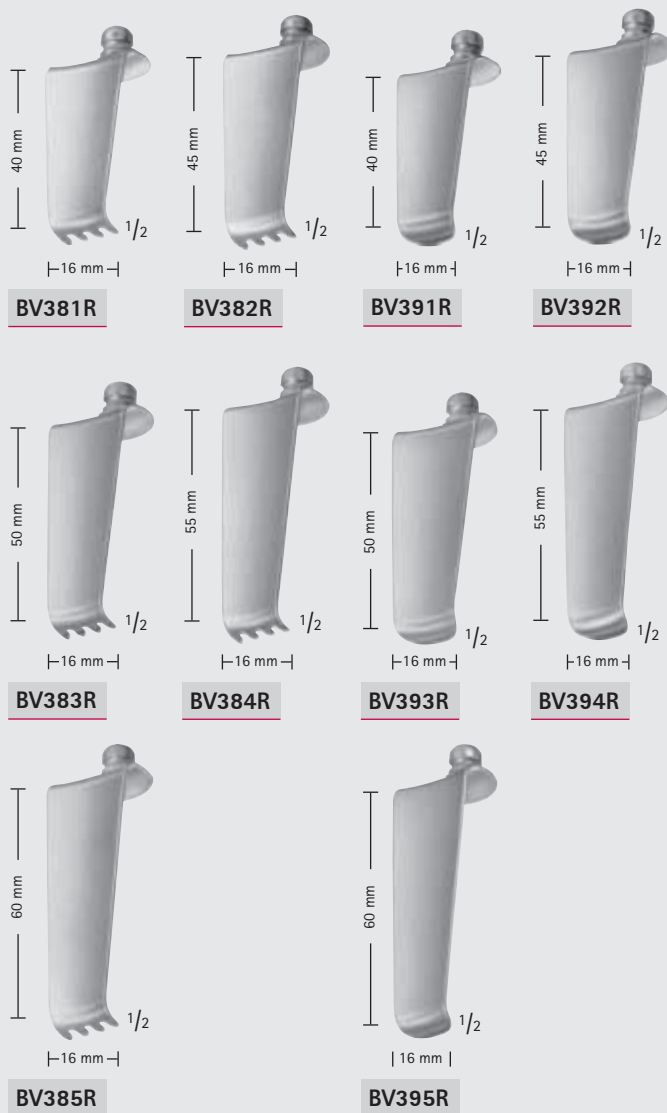

CLOWARD MODIF.

**BV380R**

Sperrer komplett,  
bestehend aus:

- BV379R Sperrer allein
- BV381R Blatt
- BV382R Blatt
- BV383R Blatt
- BV384R Blatt
- BV385R Blatt

Retractor complete,  
consisting of:

- BV379R Spreader only
- BV381R Blade
- BV382R Blade
- BV383R Blade
- BV384R Blade
- BV385R Blade

10 mm, 250 "

**BV381R-BV395R**

Blätter allein zu BV379R  
Blades only for BV379R





# Wundspreizer, Bauchdeckenhalter – Self-Retaining Retractors, Abdominal Retractors

Wirbelkörperspreizer  
Lamina Spreaders

BV



CLOWARD

**BV296R**

155 mm, 6"



CLOWARD

**BV299R**

135 mm, 5 1/4"

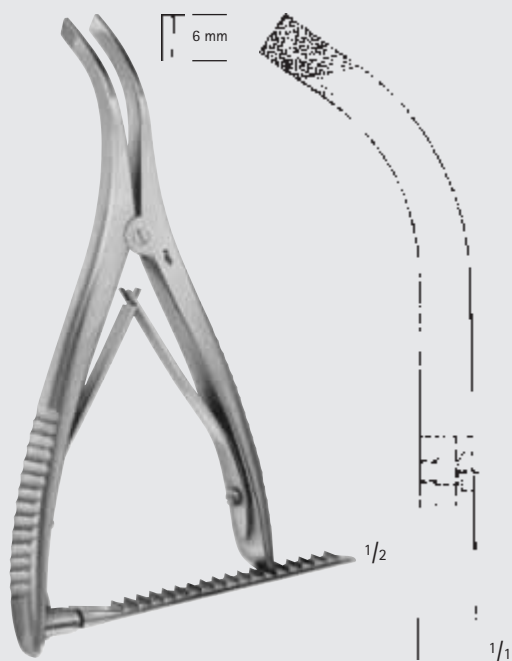

INGE

**BV297R**

170 mm, 6 3/4"

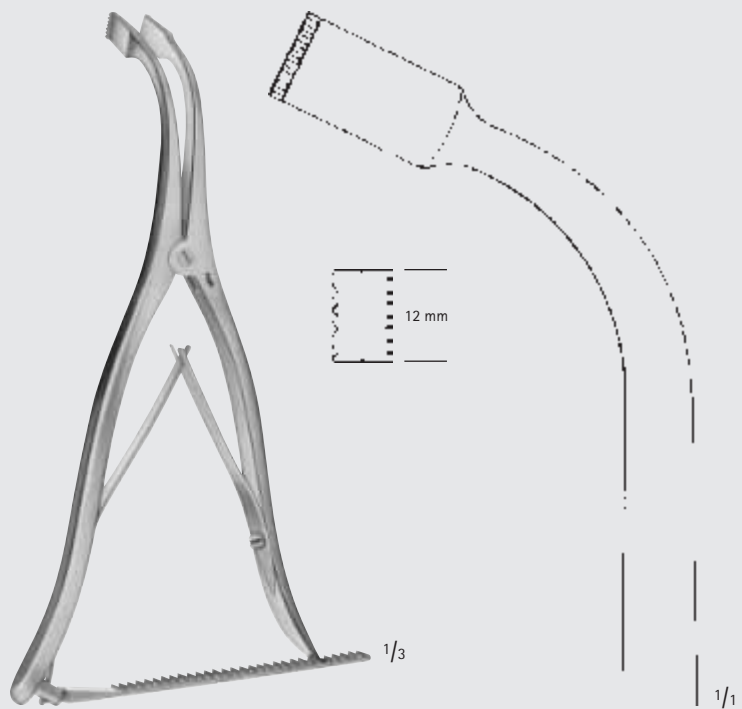

INGE

**BV298R**

275 mm, 10 3/4"

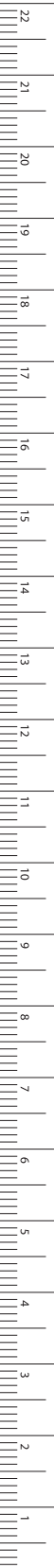

MILLIMETERS

# Wundspreizer, Bauchdeckenhalter – Self-Retaining Retractors, Abdominal Retractors

Bauchdeckenhalter  
Abdominal Retractors

KUGELSCHNELLVERSCHLUSS  
BALL SNAP CLOSURE



BV



BABY-COLLIN

**BV329R**

Sperrer komplett,  
bestehend aus:

- BV327R Sperrer allein
- BV326R Blätter (Paar)  
18 x 42 mm
- BV328R Blätter (Paar)  
28 x 42 mm

Retractor complete,  
consisting of:

- BV327R Spreader only
- BV326R Blades (pair)  
18 x 42 mm
- BV328R Blades (pair)  
28 x 42 mm

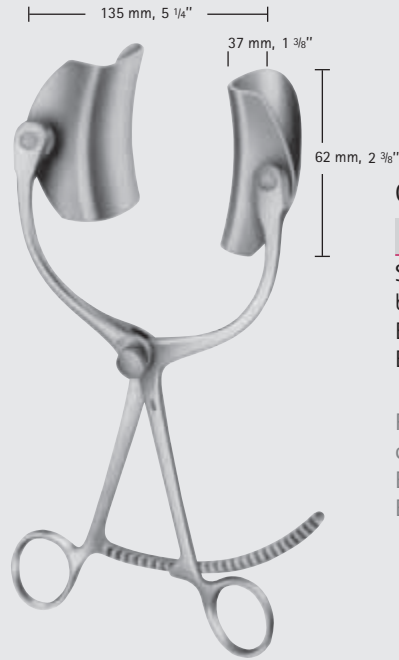

COLLIN

**BV530R**

Sperrer komplett,  
bestehend aus:

- BV520R Sperrer allein
- BV551R Blätter (Paar)

Retractor complete,  
consisting of:

- BV520R Spreader only
- BV551R Blades (pair)



COLLIN

**BV531R-BV533R**

komplett complete	<b>BV531R</b>	<b>BV532R</b>	<b>BV533R</b>
Sperrer allein	<b>BV522R</b>	<b>BV523R</b>	<b>BV523R</b>
Spreader only			
Seitl. Blätter (Paar) Lateral blades (pair)	<b>BV551R</b> 37 x 62 mm	<b>BV552R</b> 37 x 80 mm	<b>BV553R</b> 37 x 98 mm
Mittelblatt Center blade	<b>BV361R</b> 54 x 55 mm	<b>BV362R</b> 54 x 67 mm	<b>BV363R</b> 52 x 76 mm



COLLIN

**BV535R-BV536R**

komplett complete	<b>BV535R</b>	<b>BV536R</b>
Sperrer allein	<b>BV524R</b>	<b>BV524R</b>
Spreader only		
Seitl. Blätter (Paar) Lateral blades (pair)	<b>BV555R</b> 48 x 59 mm	<b>BV554R</b> 61 x 80 mm
Mittelblatt Center blade	<b>BV338R</b> 63 x 74 mm	<b>BV338R</b> 63 x 74 mm



# Wundspreizer, Bauchdeckenhalter – Self-Retaining Retractors, Abdominal Retractors

 KUGELSCHNELLVERSCHLUSS  
BALL SNAP CLOSURE

Bauchdeckenhalter  
Abdominal Retractors

**BV**

320 mm, 12 1/2"



**RICARD**

**BV542R-BV543R**

komplett		
complete	<b>BV542R</b>	<b>BV543R</b>
Sperrer allein	<b>BV527R</b>	<b>BV527R</b>
Spreader only		
Seitl. Blätter (Paar)	<b>BV556R</b>	<b>BV557R</b>
Lateral blades (pair)	58 x 80 mm	72 x 84 mm
Mittelblatt	<b>BV366R</b>	<b>BV367R</b>
Center blade	54 x 70 mm	72 x 90 mm

275 mm, 10 3/4"



**HOLZBACH**

**BV545R**

komplett		
complete		
Seitl. Blätter (Paar)	<b>BV558R</b>	
Lateral blades (pair)	59 x 80 mm	
Mittelblatt		<b>BV369R</b>
Center blade		74 x 82 mm

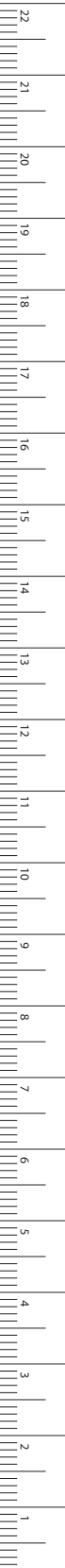

MILLIMETERS

# Wundspreizer, Bauchdeckenhalter – Self-Retaining Retractors, Abdominal Retractors

Bauchdeckenvalven

Abdominal Blades



KUGELSCHNELLVERSCHLUSS  
BALL SNAP CLOSURE

Bestelleinheit der Blätter: PAA = Paar

Sales unit of blades: PAA = pair

Seitliche Blätter allein

Lateral blades only



BV551R-BV553R

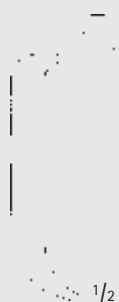

BV554R

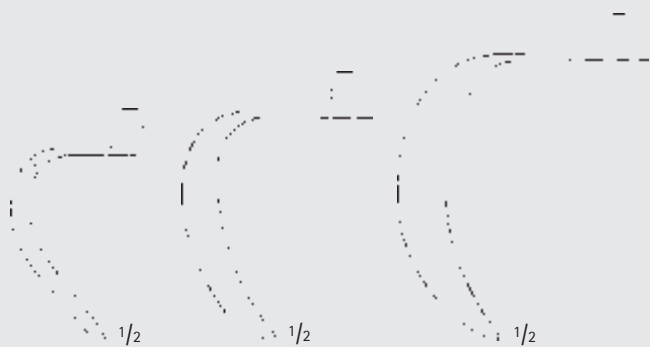

BV555R-BV557R



BV558R



BV551R 37 x 62 mm

BV552R 37 x 80 mm

BV553R 37 x 98 mm



BV554R 61 x 80 mm



BV555R 48 x 59 mm

BV556R 58 x 80 mm

BV557R 72 x 84 mm



BV558R 59 x 80 mm







# Wundspreizer, Bauchdeckenhalter – Self-Retaining Retractors, Abdominal Retractors

Bauchdeckenhalter  
Abdominal Retractors

BV

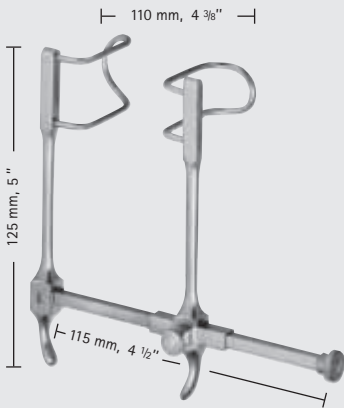

GOSSET

**BV500R**

Blätter: 38 mm tief

Blades: 38 mm deep

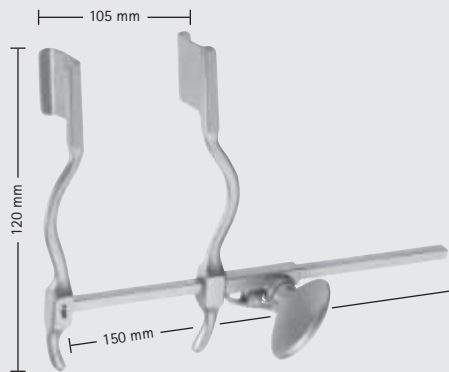

HERTZLER

**BV512R**

Blätter 20 x 25 mm

Blades 20 x 25 mm

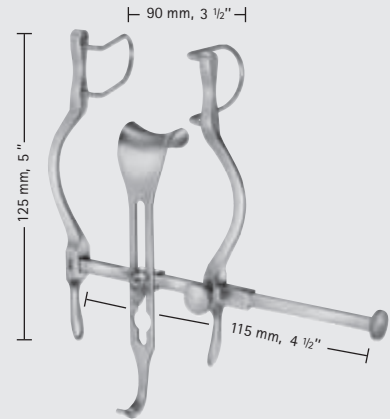

BALFOUR-BABY

**BV601R**

Seitl. Blätter 27 mm tief

Mittelblatt BV602R 21 x 24 mm

Lateral blades 27 mm deep

Center blade BV602R 21 x 24 mm

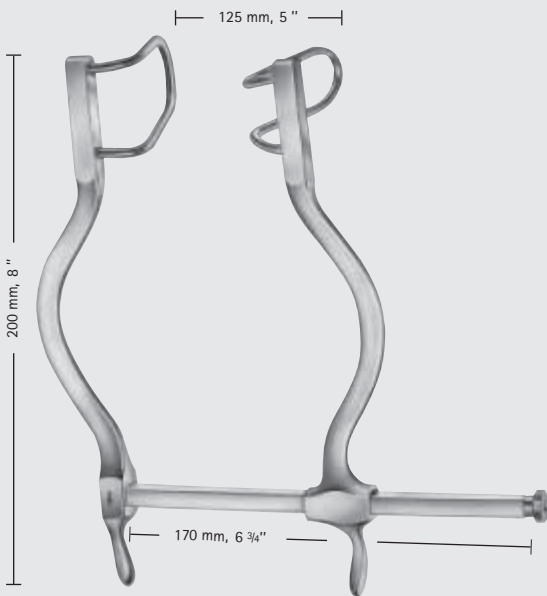

GOSSET

**BV502R**

Blätter: 55 mm tief

Blades: 55 mm deep

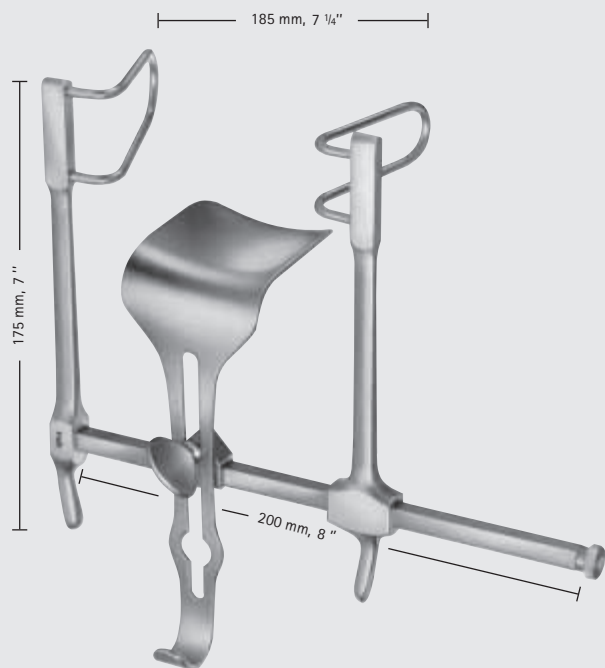

GOSSET

**BV505R**

Seitl. Blätter 58 mm tief

Mittelblatt BV506R 59 x 57 mm

Lateral blades 58 mm deep

Center blade BV506R 59 x 57 mm

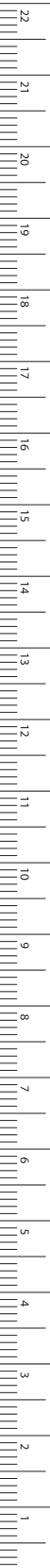

MILLIMETERS

# Wundspreizer, Bauchdeckenhalter – Self-Retaining Retractors, Abdominal Retractors

Bauchdeckenhalter

Abdominal Retractors

BV

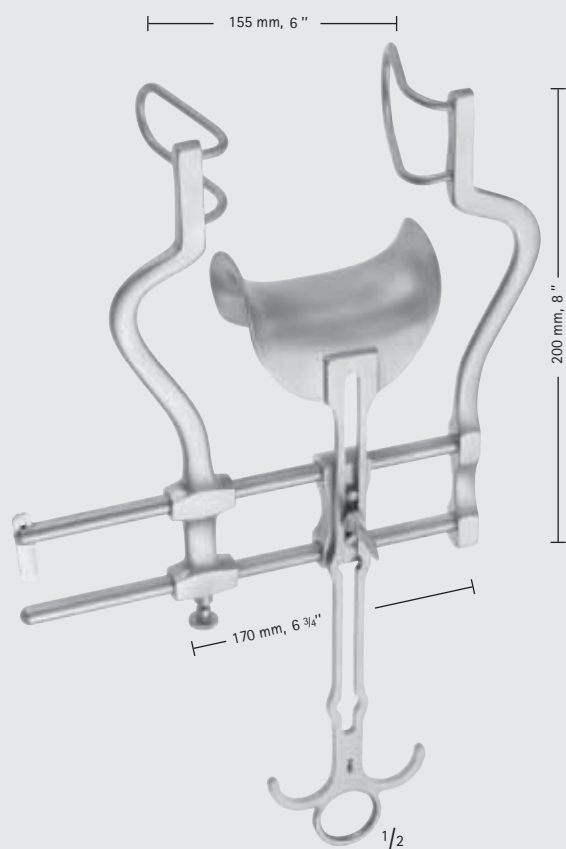

BALFOUR

**BV605R**

Seitl. Blätter	60 mm tief
Mittelblatt	BV606R 47 x 80 mm
Lateral blade	60 mm deep
Center blade	BV606R 47 x 80 mm

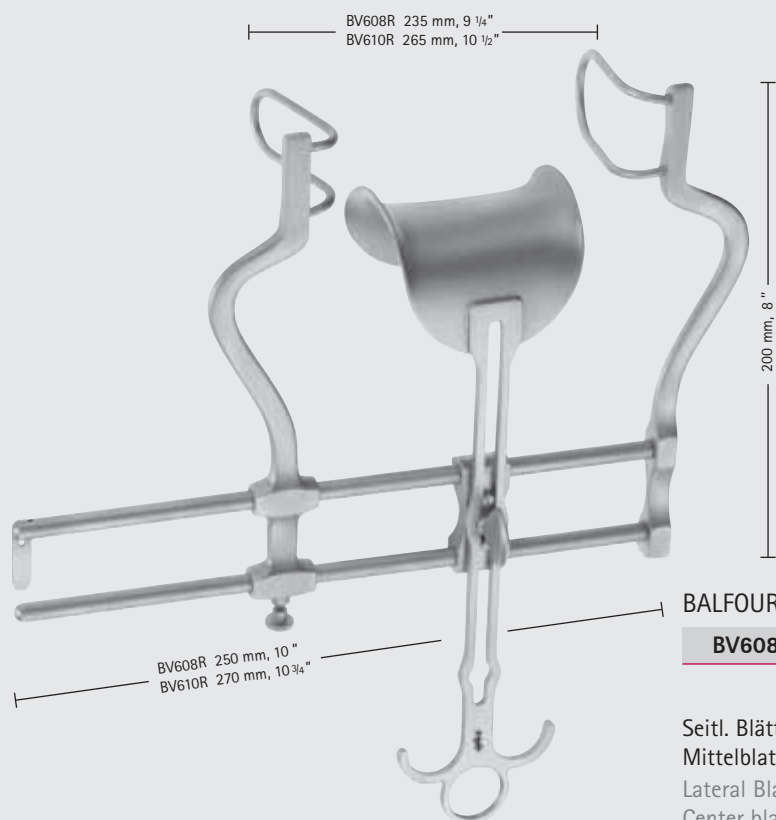

BALFOUR

**BV608R-BV610R**

	<b>BV608R</b>	<b>BV610R</b>
Seitl. Blätter	60 mm tief	90 mm tief
Mittelblatt	BV609R 62 x 76 mm	BV611R 80 x 80 mm
Lateral Blades	60 mm deep	90 mm deep
Center blade	BV609R 62 x 76 mm	BV611R 80 x 80 mm



# Wundspreizer, Bauchdeckenhalter – Self-Retaining Retractors, Abdominal Retractors

Bauchdeckenhalter  
Abdominal Retractors

**BV**

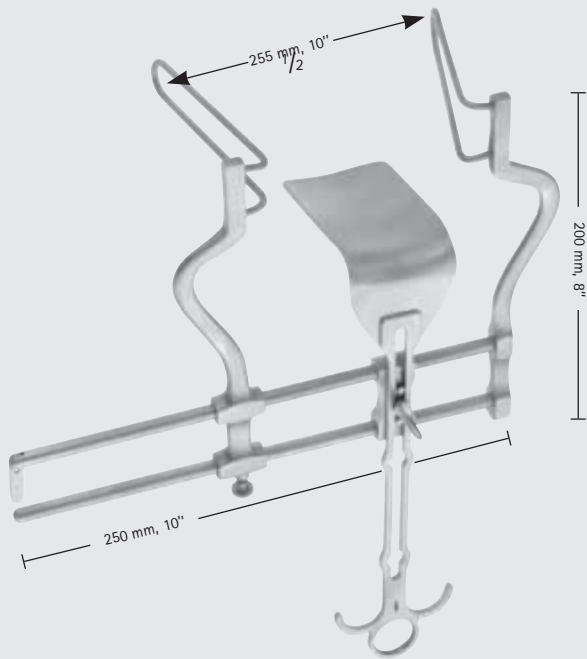

BALFOUR

**BV615R**

Seitl. Blätter 105 mm tief  
Mittelblatt BV616R 107 x 59 mm  
Lateral blades 105 mm deep  
Center blade BV616R 107 x 59 mm

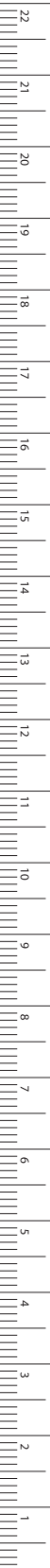

MILLIMETERS



BALFOUR

**BV617R**

Mittelblatt allein  
Center blade only  
54 x 80 mm



**BV618R**

Mittelblatt, geschlitzt  
zur retropubischen Prostatektomie  
Center blade, slotted  
for retropubic prostatectomy  
75 x 80 mm

# Wundspreizer, Bauchdeckenhalter – Self-Retaining Retractors, Abdominal Retractors

Bauchdeckenhalter

Abdominal Retractors



KUGELSCHNELLVERSCHLUSS  
BALL SNAP CLOSURE

Bestelleinheit der Blätter: PAA = Paar

Sales unit of blades: PAA = pair

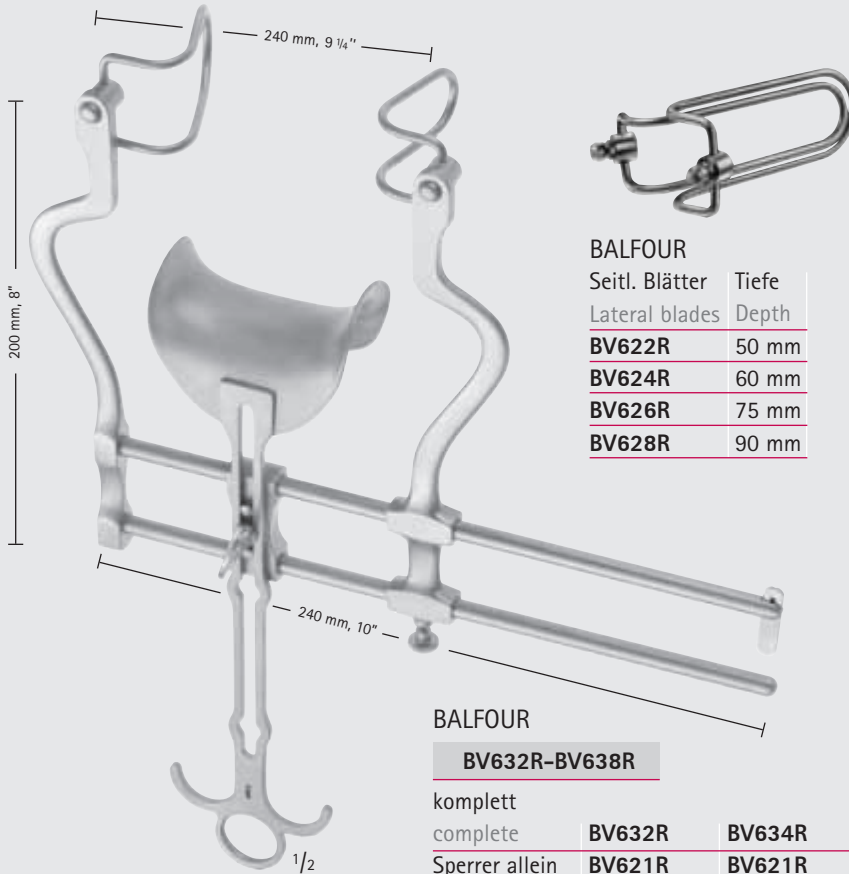

BALFOUR

Seitl. Blätter Lateral blades	Tiefe Depth
<b>BV622R</b>	50 mm
<b>BV624R</b>	60 mm
<b>BV626R</b>	75 mm
<b>BV628R</b>	90 mm

BALFOUR

**BV632R-BV638R**

komplett

complete	<b>BV632R</b>	<b>BV634R</b>	<b>BV636R</b>	<b>BV638R</b>
Sperrer allein Spreader only	<b>BV621R</b>	<b>BV621R</b>	<b>BV621R</b>	<b>BV621R</b>
Seitl. Blätter Lateral blades	<b>BV622R</b> 50 mm	<b>BV624R</b> 60 mm	<b>BV626R</b> 75 mm	<b>BV628R</b> 90 mm
Mittelblatt Center blade	<b>BV606R</b> 47 x 80 mm	<b>BV609R</b> 62 x 76 mm	<b>BV611R</b> 80 x 80 mm	<b>BV611R</b> 80 x 80 mm

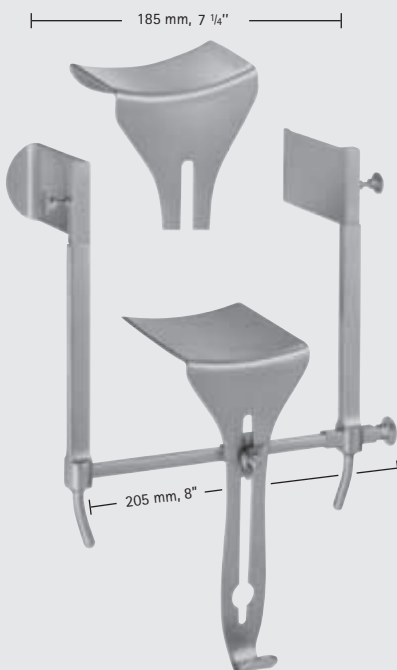

GOLIGHER

**BV640R**

Bauchdeckenhalter komplett,  
bestehend aus:

- Mittelblatt 51 mm tief
- Mittelblatt 102 mm tief
- Seitl. Blätter (Paar) 51 mm tief
- Seitl. Blätter (Paar) 102 mm tief

Abdominal retractor complete,  
consisting of:

- Center blade 51 mm deep
- Center blade 102 mm deep
- Lateral blades (pair) 51 mm deep
- Lateral blades (pair) 102 mm deep



## Wundspreizer, Bauchdeckenhalter – Self-Retaining Retractors, Abdominal Retractors

Bauchdeckenhalter  
Abdominal Retractors

BV



### O' SULLIVAN-O' CONNOR

#### US100

Bauchdeckenhalter komplett,  
bestehend aus:

- US100 1 Bauchdeckenhalter
- US100201 2 Blätter
- US100202 1 Blatt

Abdominal retractor complete,  
consisting of:

- US100 1 Retractor
- US100201 2 Blades
- US100202 1 Blade



### O'SULLIVAN-O' CONNOER

#### US100201

kleines Blatt  
small blade



### O'SULLIVAN-O' CONNOER

#### US100202

großes Blatt  
large blade

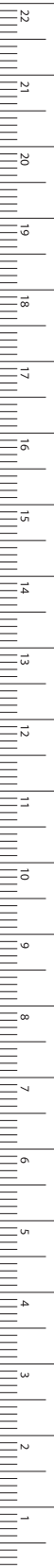

MILLIMETERS

# Wundspreizer, Bauchdeckenhalter – Self-Retaining Retractors, Abdominal Retractors

Bauchdeckenhalter

Abdominal Retractors

Bauchdeckenhalter für Säuglinge und Kinder

Abdominal retractors for new-born and children

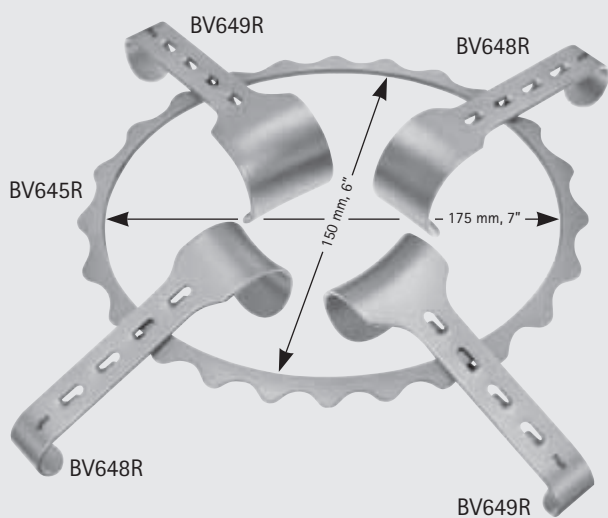

DENIS-BROWNE

## BV650R

Bauchdeckenhalter komplett,  
bestehend aus:

- BV645R 1 Rahmen 175 x 150 mm
- BV648R 2 Blätter allein 40 x 30 mm
- BV649R 2 Blätter allein 40 x 40 mm

Abdominal retractor complete,  
consisting of:

- BV645R 1 frame 175 x 150 mm
- BV648R 2 blades only 40 x 30 mm
- BV649R 2 blades only 40 x 40 mm



DENIS-BROWNE

## BV646R

Blatt allein  
Blade only  
20 x 30 mm



DENIS-BROWNE

## BV647R

Blatt allein  
Blade only  
20 x 40 mm



# Wundspreizer, Bauchdeckenhalter – Self-Retaining Retractors, Abdominal Retractors

Bauchdeckenhalter  
Abdominal Retractors

Bauchdeckenhalter für Gynäkologen gut geeignet  
Abdominal retractors well suitable for gynaecologists

BV

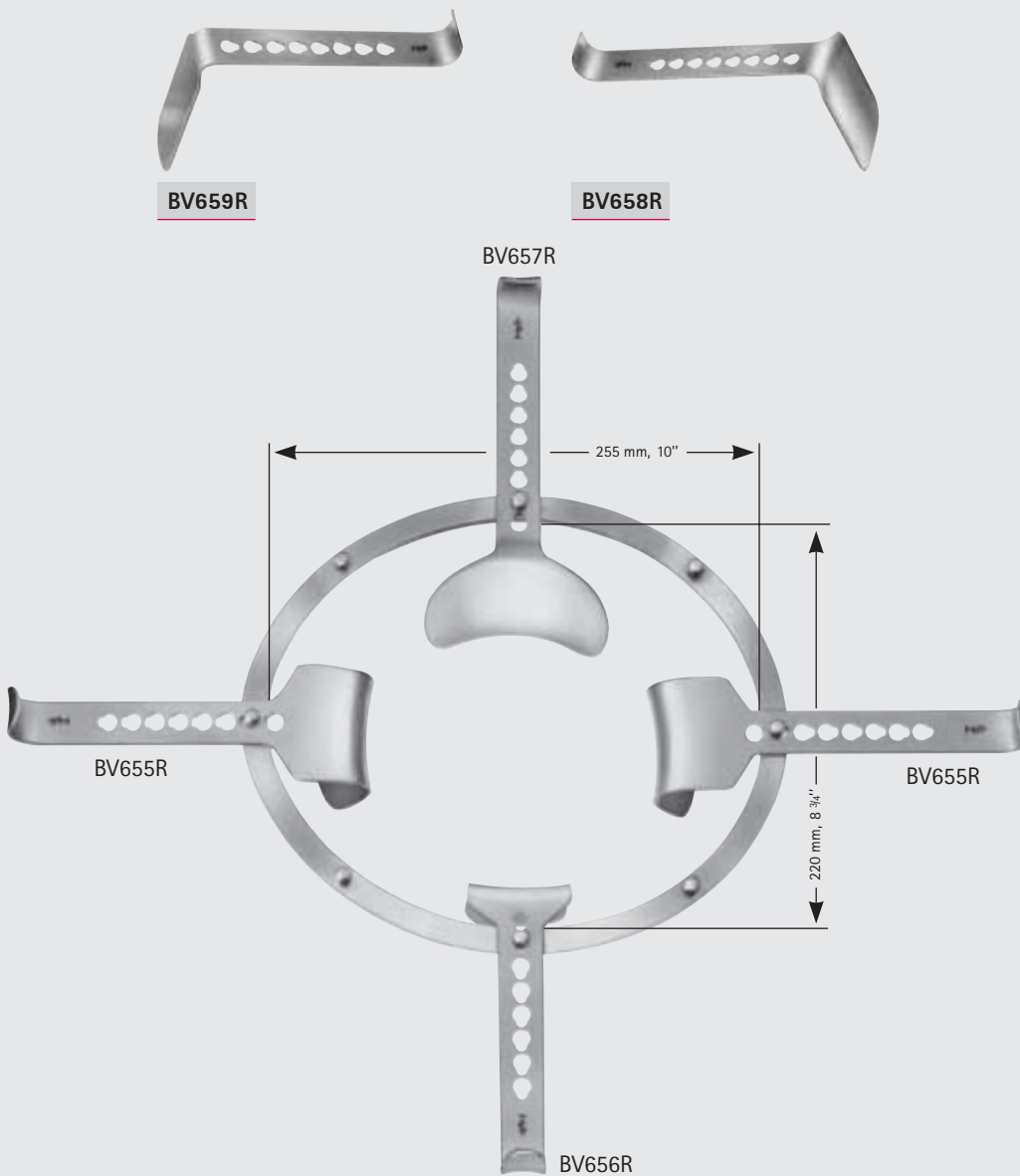

## SEMM

### BV654R

Bauchdeckenhalter komplett,  
bestehend aus:

- BV653R 1 Rahmen 255 x 220 mm
- BV655R 2 Blätter 46 x 64 mm
- BV656R 1 Blatt 53 x 54 mm (für die Blase)
- BV657R 1 Blatt 82 x 97 mm (für den Darm)
- BV658R 1 Blatt 98 x 51 mm (für den Darm)
- BV659R 1 Blatt schmal 107 x 36 mm

Abdominal retractor complete,  
consisting of:

- BV653R 1 frame 255 x 220 mm
- BV655R 2 blades 46 x 64 mm
- BV656R 1 blade 53 x 54 mm (for bladder)
- BV657R 1 blade 82 x 97 mm (for intestine)
- BV658R 1 blade 98 x 51 mm (for intestine)
- BV659R 1 blade narrow 107 x 36 mm

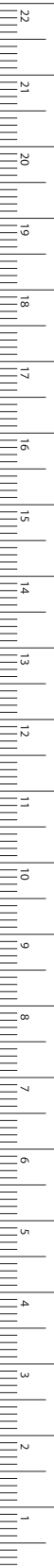

MILLIMETERS

# Wundspreizer, Bauchdeckenhalter – Self-Retaining Retractors, Abdominal Retractors

Bauchdeckenhalter

Abdominal Retractors

BV

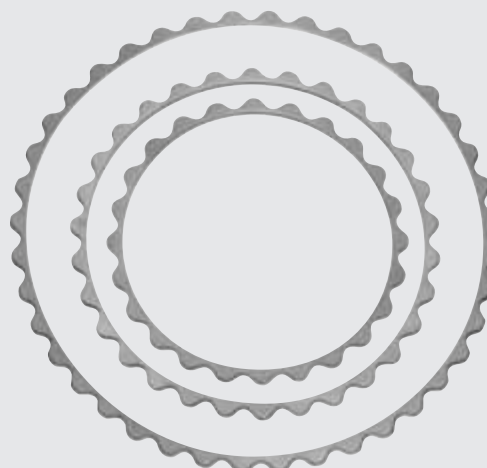

**BV686R**

ø 180 mm  
diam 7"

**BV687R**

ø 230 mm  
diam. 9"

**BV688R**

ø 305 mm  
diam. 12"

TURNER-WARWICK

**BV686R**

Bauchdeckenrahmen, rund  
Retractor frame, round

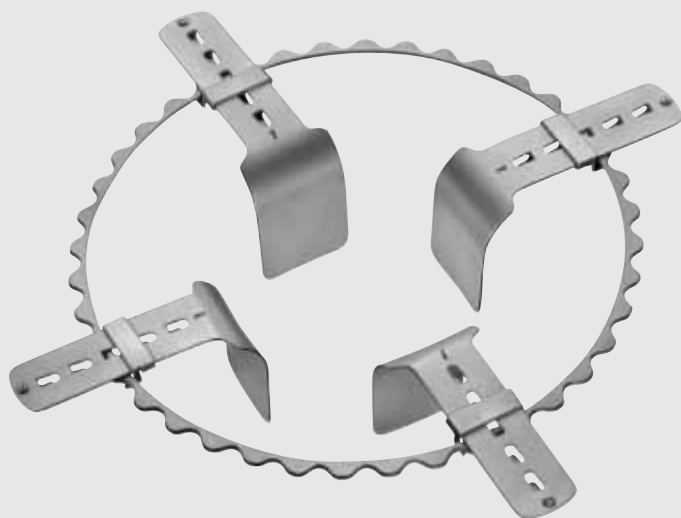

TURNER-WARWICK

**BV685R**

Bauchdeckenhalter komplett,  
bestehend aus:

BV686R - BV688R je 1 Rahmen  
BV690R - BV693R je 2 Bauchdeckenspatel  
BV694R - BV695R je 2 Bauchdeckenhaken  
BV696R - BV697R je 2 Bauchdeckenhaken  
BV698R 2 Einzinkerhaken

Abdominal retractor complete,  
consisting of:

BV686R - BV688R 1 Frame of each  
BV690R - BV693R 2 Retractor blades of each  
BV694R - BV695R 2 Abdominal retractors of each  
BV696R - BV697R 2 Abdominal retractors of each  
BV698R 2 Retractor blade single hooks



TURNER-WARWICK

**BV689R**

Bauchdeckenrahmen, oval  
Retractor frame, oval  
457 x 330 mm,





## Wundspreizer, Bauchdeckenhalter – Self-Retaining Retractors, Abdominal Retractors

Bauchdeckenhalter  
Abdominal Retractors

**BV**

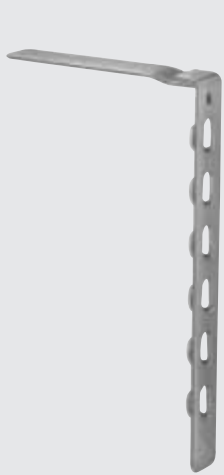

**BV690R**

biegsam  
malleable  
76 x 19 mm

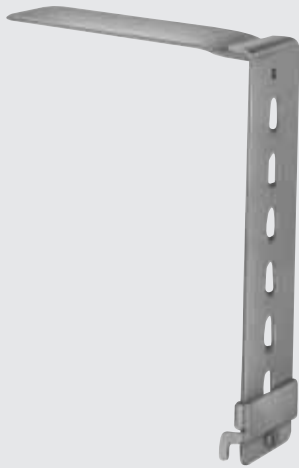

**BV691R**

biegsam  
malleable  
102 x 38 mm



**BV692R**

biegsam  
malleable  
89 x 57 mm

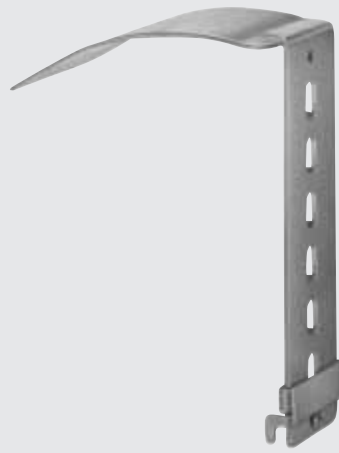

**BV693R**

biegsam  
malleable  
114 x 57 mm



**BV694R**

51 x 38 mm



**BV695R**

76 x 60 mm

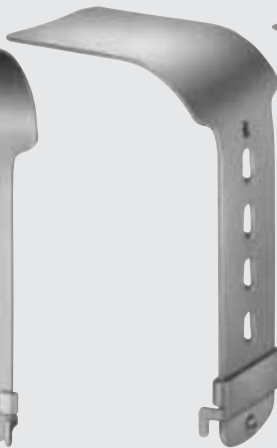

**BV696R**

89 x 60 mm

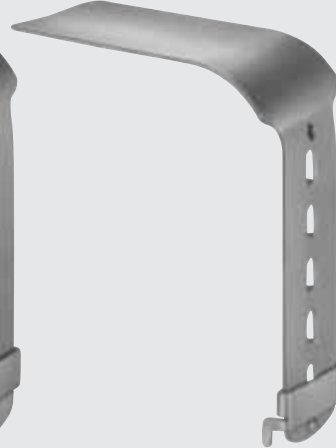

**BV697R**

114 x 60 mm



**BV698R**

13 mm tief  
13 mm deep

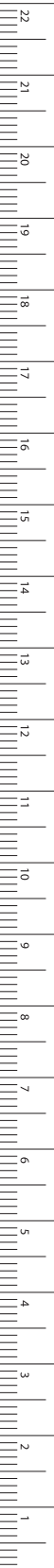

MILLIMETERS

# Wundspreizer, Bauchdeckenhalter – Self-Retaining Retractors, Abdominal Retractors

Bauchdeckenhalter

Abdominal Retractors

BV



250 x 250 mm, 10 x 10"

KIRSCHNER

**BV662R**

Bauchdeckenhalter komplett, bestehend aus:

- BV663R 1 Rahmen, zusammenlegbar
- BV668R 2 Blätter
- BV669R 2 Blätter

Abdominal retractor complete, consisting of:

- BV663R 1 Holding frame
- BV668R 2 Blades
- BV669R 2 Blades

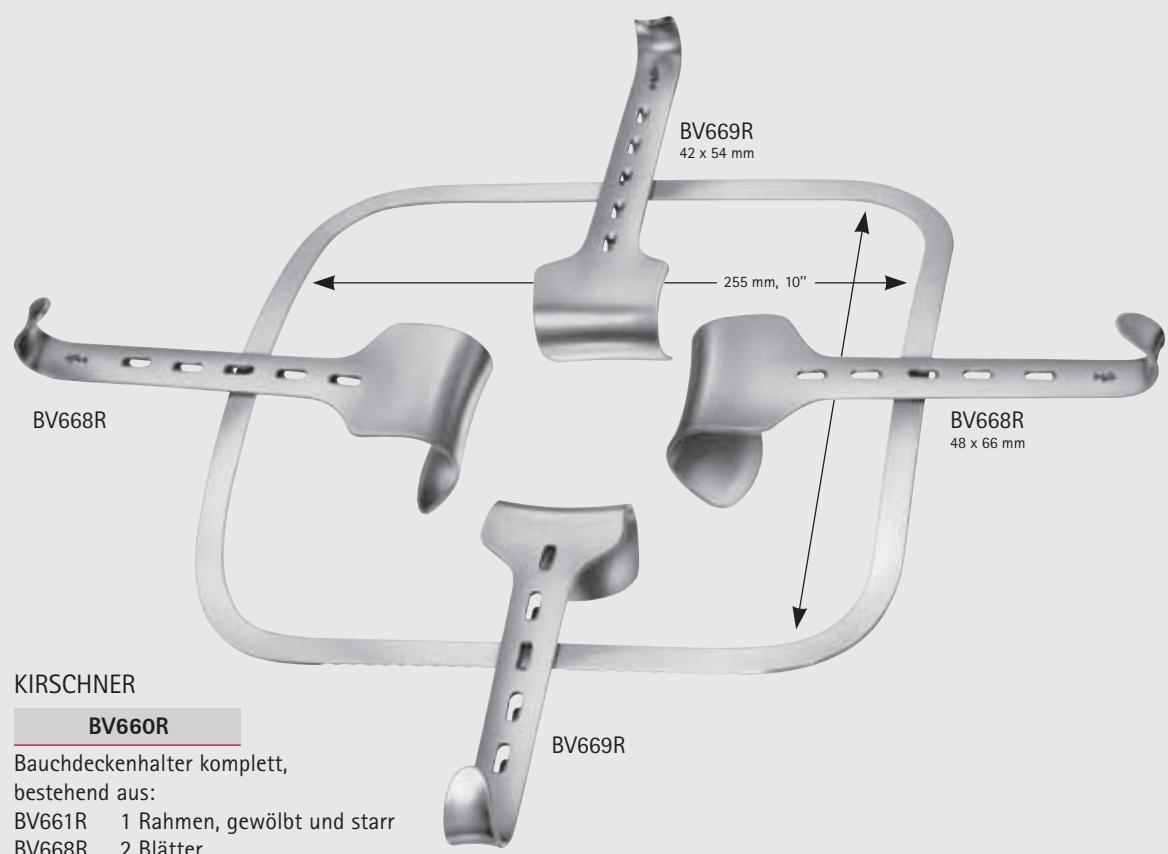

BV669R  
42 x 54 mm

255 mm, 10"

BV668R

BV668R  
48 x 66 mm

BV669R

KIRSCHNER

**BV660R**

Bauchdeckenhalter komplett, bestehend aus:

- BV661R 1 Rahmen, gewölbt und starr
- BV668R 2 Blätter
- BV669R 2 Blätter

Abdominal retractor complete, consisting of:

- BV661R 1 Vaulted fixed frame
- BV668R 2 Blades
- BV669R 2 Blades

KIRSCHNER

**BV664R**

Rahmen allein, übergroß  
Frame only, over-sized  
275 x 355 mm

KIRSCHNER

**BV665R**

Rahmen allein  
Frame only  
295 x 275 mm



# Wundpreizer, Bauchdeckenhalter – Self-Retaining Retractors, Abdominal Retractors

Bauchdeckenhalter  
Abdominal Retractors

Zusätzliche Blätter für Fettleibige  
Additional valves for corpulent persons

**BV**



KIRSCHNER

**BV670R**

64 x 80 mm



KIRSCHNER-BALFOUR

**BV672R**

80 x 82 mm



KIRSCHNER

**BV674R** 90 x 69 mm

**BV675R** 95 x 95 mm

**BV676R** 78 x 58 mm



KIRSCHNER

**BV680R** 108 x 42 mm

**BV682R** 91 x 55 mm

**BV684R** 120 x 55 mm

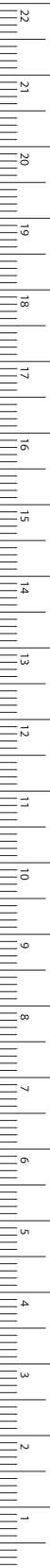

MILLIMETERS

## Wundspreizer, Bauchdeckenhalter – Self-Retaining Retractors, Abdominal Retractors

Blasenwundspreizer

Bladder Retractors



KUGELSCHNELLVERSCHLUSS  
BALL SNAP CLOSURE

BV



BV576R



BV577R

MILLIN

### BV580R

Blasenwundspreizer komplett,  
bestehend aus:

- BV575R Sperrer allein
- BV576R Blätter 57 x 25 mm
- BV577R Blätter 82 x 25 mm
- BV578R Mittelblatt 105 x 45 mm

Bladder retractor complete,  
consisting of:

- BV575R Spreader only
- BV576R Blades 57 x 25 mm
- BV577R Blades 82 x 25 mm
- BV578R Center blade 105 x 45 mm

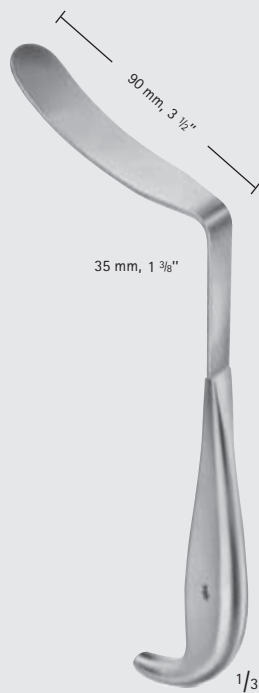

LEGUEU

### BV928R

Blasenspatel  
Bladder spatula  
260 mm, 10 1/4"



## Wundspreizer, Bauchdeckenhalter – Self-Retaining Retractors, Abdominal Retractors

Poplitea-Sperrer  
Poplitea Retractor

BV

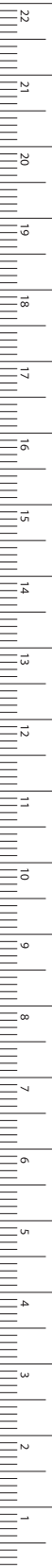

MILLIMETERS



### BV348R

Blätter (Paar), allein  
bestehend aus:  
Blatt, stumpf, 60 x 50 mm  
Blatt, halbscharf, 40 x 35 mm  
Blades (pair), only  
consisting of:  
Blade, blunt, 60 x 50 mm  
Blade, semi-sharp, 40 x 35 mm

### BV349R

Poplitea-Sperrer, komplett  
bestehend aus:  
BV327R Sperrer allein  
BV348R Blätter (Paar)  
Poplitea retractor, complete  
consisting of:  
BV327R Retractor only  
BV348R Blades (pair)

„Einer für Alle“  
"One for All"



**Ein** System für alle Indikationen in

- Viszeralchirurgie
- Urologie
- Gynäkologie
- Abdominale Gefäßchirurgie

Eine Vielzahl an Rahmen, Klemmen, Stangen und Wundhaken ermöglicht es, ein individuell angepasstes Retraktions-System zusammenzustellen, welches praktisch keine Wünsche mehr offen lässt.

**One** system for all indications in

- Visceral surgery
- Urology
- Gynaecology
- Abdominal vascular surgery

The multiplicity of different frames, clamps, rods and retractors permits an individually adjustable retraction system which corresponds to the needs of the customers.



## Wundspreizer, Bauchdeckenhalter – Self-Retaining Retractors, Abdominal Retractors

Retraktions-System MÜNSTER  
MÜNSTER Retraction System

BV

universell, flexibel, sicher, einfach in der Handhabung  
universal, safe, easy to use

Weitere Informationen finden  
Sie in unserem Prospekt **C216**.

For further details see  
brochure No. **C216**.

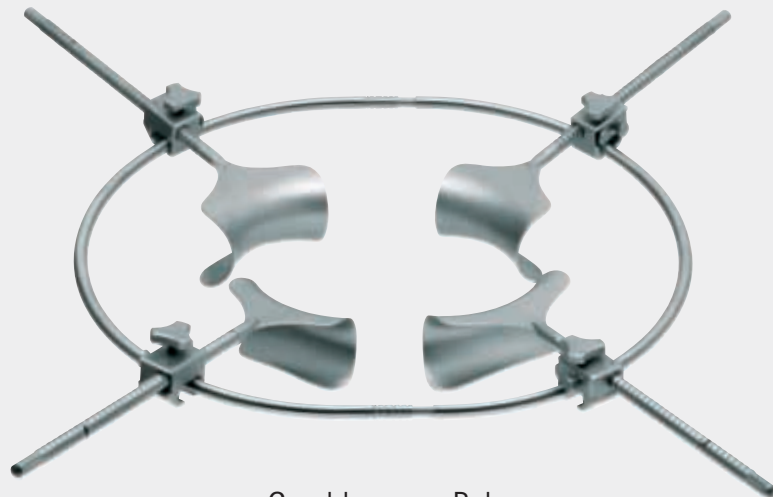

Geschlossener Rahmen  
Closed frame



Offener Rahmen  
Open frame

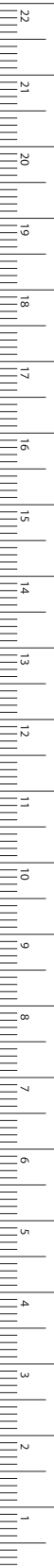

MILLIMETERS

## Das Mini Retraktionssystem

### The Mini Retraction System



Das Retraktionssystem FRANKFURT ist ein universelles Mini Retraktionssystem.

Die Position der Wundhaken auf den Rahmen kann frei gewählt werden. Die Wundhaken sind durch spezielle Befestigungsklemmen mit den Rahmen verbunden und können in allen Dimensionen bewegt werden.

The FRANKFURT retraction system is a universal mini retraction system.

The retractors can be positioned anywhere on the frame. The retractors are fixed to the frame with special fixation clamps and can be moved in any direction and in all dimensions.







## Wundspreizer, Bauchdeckenhalter – Self-Retaining Retractors, Abdominal Retractors

Retraktions-System FRANKFURT  
FRANKFURT Retraction System

BV

Weitere Informationen finden  
Sie in unserem Prospekt **C779**.

For further details see  
brochure No. **C779**.



Für die Kinderchirurgie  
For Pediatric Surgery

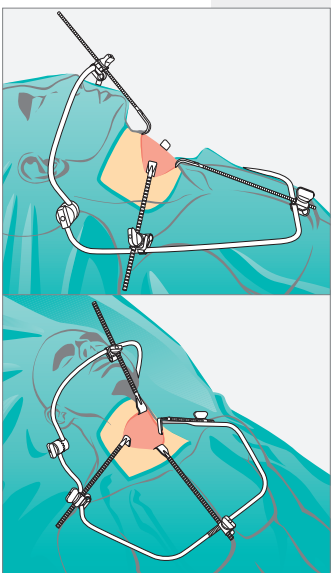

Für Struma Operationen  
For Thyroid Operations

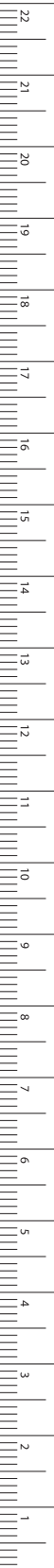

MILLIMETERS

## Wundspreizer, Bauchdeckenhalter – Self-Retaining Retractors, Abdominal Retractors

UNITRAC® - Retraktions- und Haltesystem

UNITRAC® - Retraction- and Holding System

BV

Retraktion in Perfektion

Retraction in Perfection



Das Retraktions- und Haltesystem für die

- Offene Chirurgie
- Minimalinvasive Chirurgie
- Orthopädie
- Traumatologie

The retraction and holding system for

- Open Surgery
- Minimal Invasive Surgery
- Orthopaedics
- Traumatology





## Wundspreizer, Bauchdeckenhalter – Self-Retaining Retractors, Abdominal Retractors UNITRAC® - Retraktions- und Haltesystem UNITRAC® - Retraction- and Holding System



- ⌘ Universell einsetzbar zum Halten von Wundhaken, Kameras und Endoskopen  
Universal use for holding hooks, retractors, cameras and endoscopes
- ⌘ Umfangreiches Zubehör an Wundhaken, Kamera- und Endoskophaltern verfügbar  
Extensive range of blades, hooks, camera and endoscope holders available
- ⌘ Pneumatisch unterstütztes System zum direkten Anschluss an die vorhandene OP-Druckluftversorgung  
Pneumatically supported system for direct connection with the compressed air supply in the operating room
- Betriebsdruck: 5,5 bar bis 12 bar  
Required working pressure: 5.5 bar up to 12 bar
- ⌘ Einfache Montage an die OP-Tischschiene  
Easy to attach to operating room table
- ⌘ Schnelle und sterile Bereitstellung im OP  
Quick sterile set-up in operating room
- ⌘ Dampfsterilisierbar bei 134 °C (2 bar)  
Autoclaveable at 134 °C (2 bar)

Weitere Informationen finden Sie in unserem Prospekt **C474**.

For further details see brochure No. **C474**.

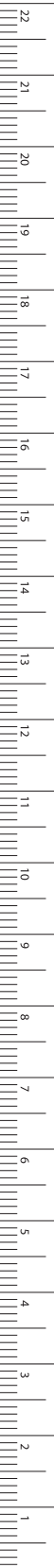

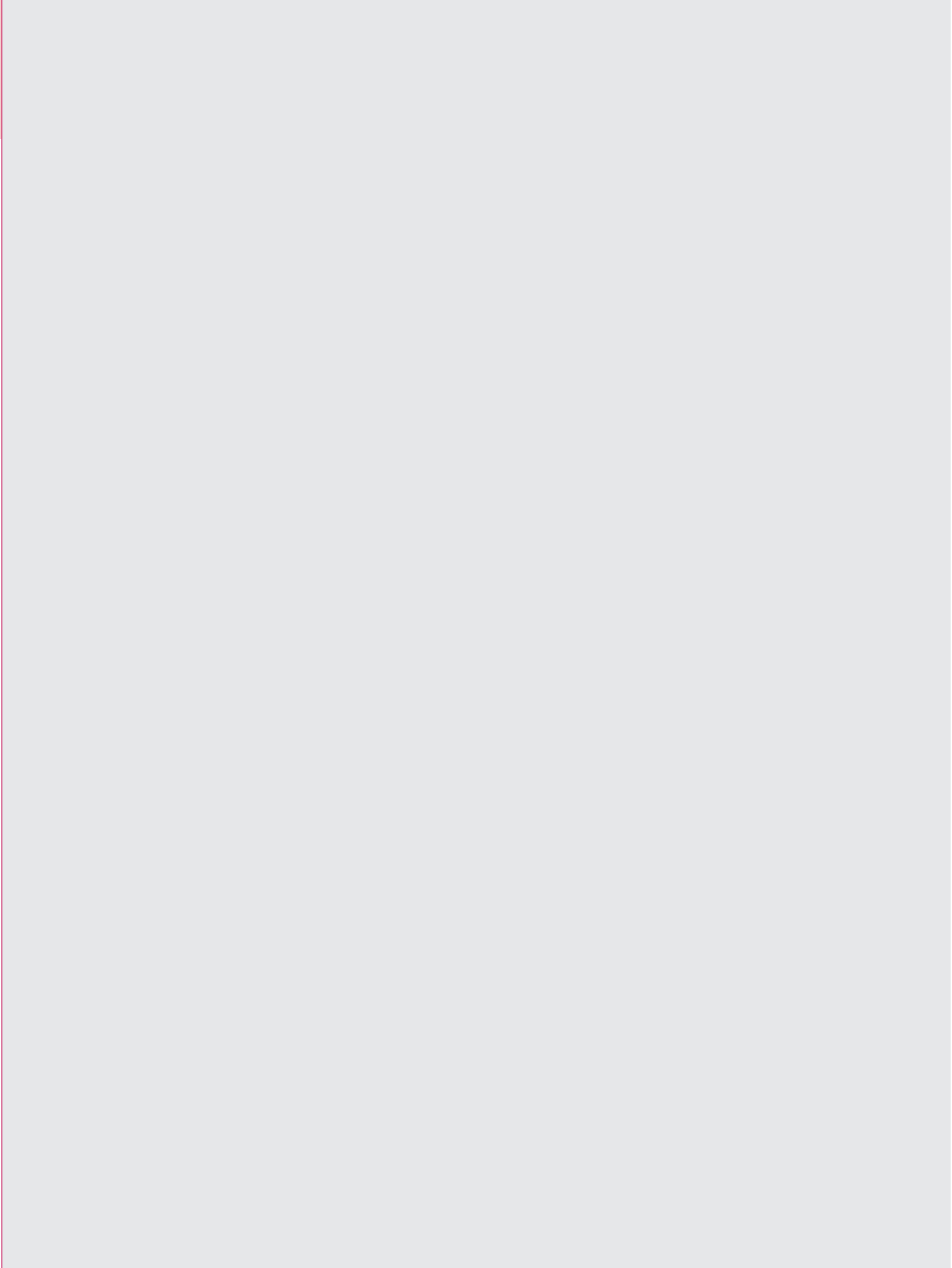



**GK**



**Elektrochirurgie**  
**Electrosurgery**

## Elektrochirurgie – Electro Surgery

### Elektrodenhandgriffe

### Electrode Handles

MONOPOLAR

passend für Geräte von Aesculap, ACMI, Berchtold, Martin, Erbe ACC/ICC/VI0  
suitable for devices from Aesculap, ACMI, Berchtold, Martin, Erbe ACC/ICC/VI0



#### GN209

Elektrodenhandgriff, mit Doppelfingertastern  
Electrode handle, with two finger pushbuttons



#### GN207

Elektrodenhandgriff, ohne Fingertaster  
Electrode handle, without finger pushbuttons

passend für Geräte von Aesculap, ACMI, Berchtold, Martin  
suitable for devices from Aesculap, ACMI, Berchtold, Martin



#### GN203-GN205

Kabel für Elektrodenhandgriff  
Cable for electrode handle

GN203	GN205
3,5 m	5,0 m

passend für Geräte von Erbe ACC/ICC/VI0  
suitable for devices from Erbe ACC/ICC/VI0



#### GN213-GN215

Kabel für Elektrodenhandgriff  
Cable for electrode handle

GN213	GN215
3,0 m	5,0 m

GK





## Elektrochirurgie – Electro Surgery

### Elektrodenhandgriffe

### Electrode Handles

## MONOPOLAR

passend für Geräte von Aesculap, ACMI, Berchtold, Conmed, Martin, Valleylab  
 suitable for devices from Aesculap, ACMI, Berchtold, Conmed, Martin, Valleylab



### GK252Y

Elektrodenhandgriff ohne Fingertaster, Stecker US-Norm  
 Electrode handle, without finger pushbuttons, plug according to US standard



### GK253Y

Elektrodenhandgriff mit Doppelfingertastern, Stecker US-Norm  
 Electrode handle, with two finger pushbuttons, plug according to US standard

passend für Geräte von Aesculap, ACMI, Berchtold, Martin  
 suitable for devices from Aesculap, ACMI, Berchtold, Martin

## Slim Style



### GN206

Elektrodenhandgriff, ohne Fingertaster  
 Electrode handle, without finger pushbuttons

## Slim Style



### GN218

Elektrodenhandgriff, ohne Fingertaster  
 Electrode handle, without finger pushbuttons

## Slim Style



### GN208

Elektrodenhandgriff, ohne Fingertaster  
 Electrode handle, without finger pushbuttons

GK

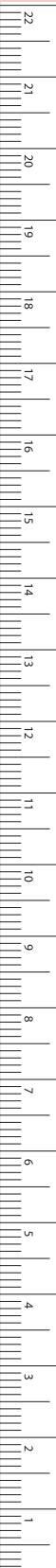

MILLIMETERS

## Elektrochirurgie – Electro Surgery

Elektrodenhandgriffe

Electrode Handles

MONOPOLAR

passend für Geräte von Aesculap, ACMI, Berchtold, Conmed, Martin, Valleylab  
suitable for devices from Aesculap, ACMI, Berchtold, Conmed, Martin, Valleylab

### Slim Style



#### GN210-GN212

Elektrodenhandgriff mit Doppelfingertastern, Stecker US-Norm

Electrode handle, with two finger pushbuttons, plug according to US standard

	GN210	GN212
ø	2,4 mm	4,0 mm
diam.	2.0 mm	4.0 mm

### Single Use



#### GN211

Einmal-Elektrodenhandgriff, mit Fingertastern, Stecker US Norm

Single use electrode handle, with finger pushbuttons, plug according to US standard

### Single Use



#### GN221

Einmal-Elektrodenhandgriff, ohne Fingertaster

Single use electrode handle, without finger pushbuttons

### Single Use

Elektrodenhandgriffe

Electrodes handles

Bestelleinheit:

PAK = Packung à 50 Stück, einzeln steril verpackt

Sales unit:

PAK = Package of 50 pieces, in individual sterile packs





# Elektrochirurgie – Electro Surgery







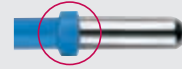

## Kurze Arbeitselektroden

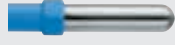
## Short Working Electrodes

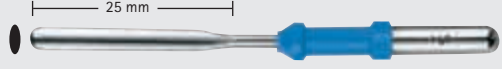
MONOPOLAR

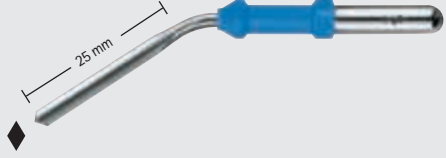
mit Sechskantverdrehschutz  
with hexagonal anti-twist protection

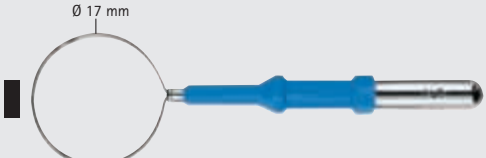

		ø 4,0 mm diam. 4.0 mm	ø 2,4 mm diam. 2.4 mm
Messerelektroden Knife electrodes		 <b>GK110R</b>	 <b>GK140R</b>
Lanzettenelektroden Cutting electrodes		<b>GK111R</b>	<b>GK141R</b>
		<b>GK112R</b>	<b>GK142R</b>
		<b>GK113R</b>	<b>GK143R</b>
Nadelelektroden Needle electrodes		<b>GK114R</b>	<b>GK144R</b>
Schlingenelektroden Loop electrodes		<b>GK115R</b>	<b>GK145R</b>
		<b>GK116R</b>	<b>GK146R</b>
		<b>GK117R</b>	<b>GK147R</b>
		<b>GK118R</b>	<b>GK148R</b>

GK

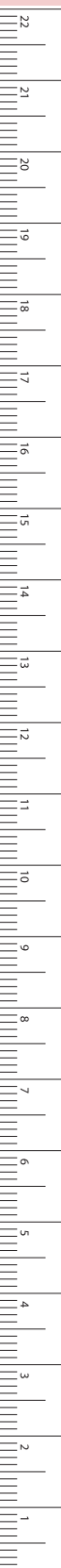

MILLIMETERS

# Elektrochirurgie – Electro Surgery

Kurze Arbeitselektroden  
Short Working Electrodes

MONOPOLAR

mit Sechskantverdreheschutz  
with hexagonal anti-twist protection

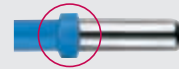

ø 4,0 mm  
diam. 4.0 mm



ø 2,4 mm  
diam. 2.4 mm



Kugelelektroden  
Ball electrodes



GK121R

GK151R



GK122R

GK152R

Plattenelektroden  
Plate electrodes

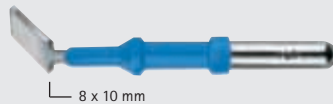

GK123R

GK153R

Chirurgie-Elektroden-Set  
bestehend aus:  
Behälter, Ständer  
und 12 Elektroden

Surgical electrodes set  
consisting of:  
container, rack  
and 12 electrodes



GK174R

## Single Use

Kugelelektrode  
Ball electrode



GK164R

## Single Use

Nadelelektrode  
Needle electrode

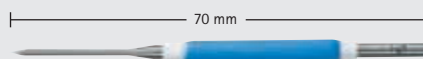

GK165R

## Single Use

Elektrodenhandgriffe

Electrodes handles

Bestelleinheit:

PAK = Packung à 50 Stück, einzeln steril verpackt

Sales unit:

PAK = Package of 50 pieces, in individual sterile packs

GK





# Elektrochirurgie – Electro Surgery

## Isolierte Langschattelektroden

### Insulated Long-Shank Electrodes

**MONOPOLAR**

mit Sechskantverdrehenschutz  
with hexagonal anti-twist protection

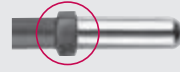

ø 4,0 mm  
diam. 4.0 mm



ø 2,4 mm  
diam. 2.4 mm

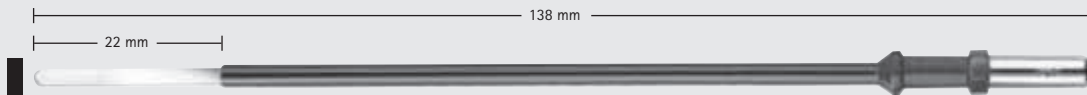

Messerelektroden  
Knife electrodes

**GK125R**

**GK155R**

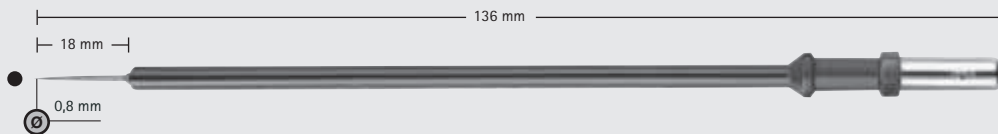

Nadelektroden  
Needle electrodes

**GK127R**

**GK157R**

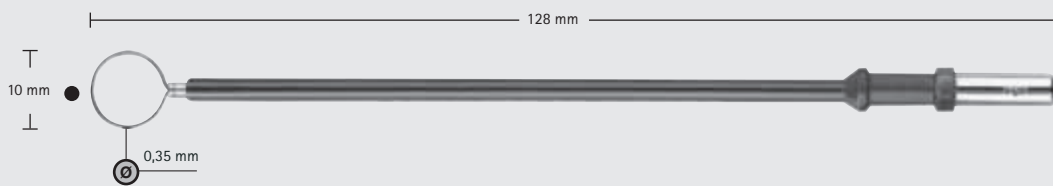

Drahtschlingenelektrode  
Wire loop electrode

**GK128R**

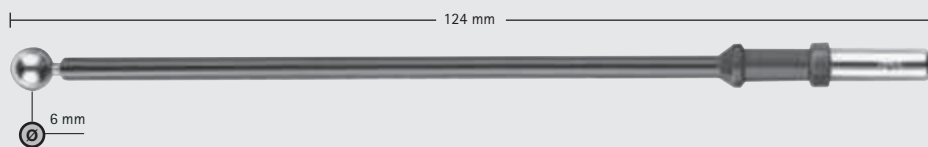

Kugelelektrode  
Ball electrode

**GK129R**

**GK**

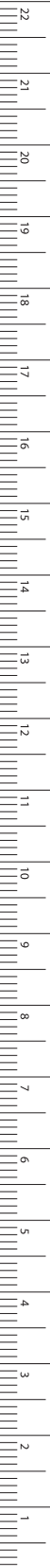

MILLIMETERS

## Elektrochirurgie – Electro Surgery

Isolierte Langschaftelektroden

Insulated Long-Shank Electrodes

MONOPOLAR

mit Sechskantverdrehschutz  
with hexagonal anti-twist protection

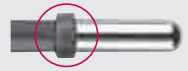

ø 4,0 mm  
diam. 4.0 mm

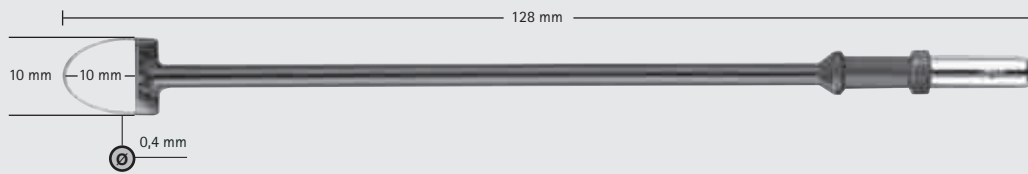

GK131R

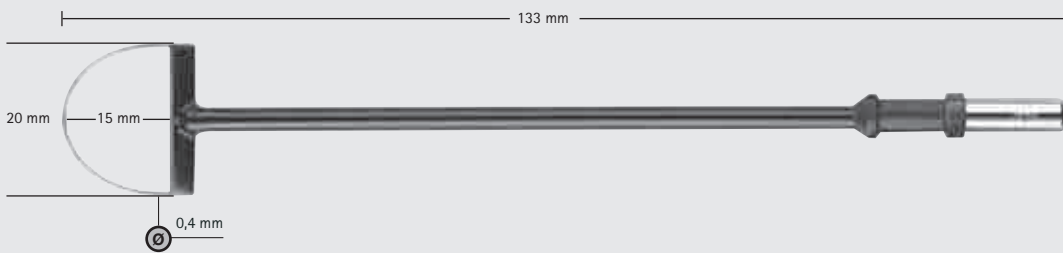

GK132R

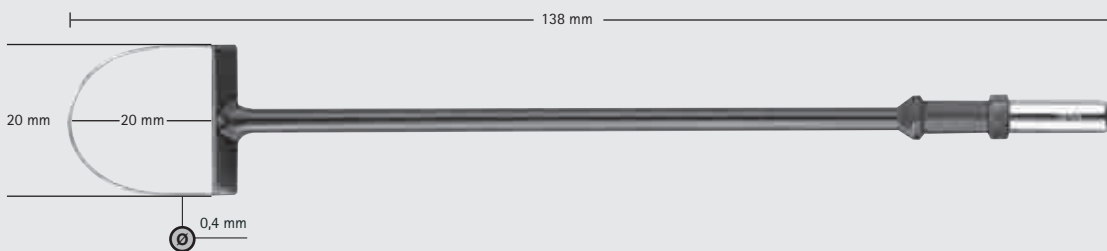

GK133R

**GK131R-GK133R**

Drahtschlingenelektroden zur Konisation der Portio

Wire loop electrodes for conization of the portio

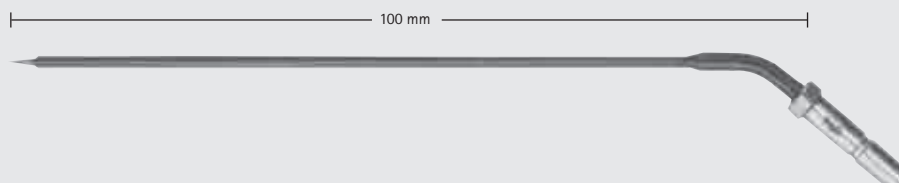

GK424

Stichkoagulationsnadel für die Nasenmuschel  
Needle electrode for nasal concha

GK





**MONOPOLAR**

**GK**



**GN227**

Elektrodenhandgriff, ohne Fingertaster  
Electrode handle, without finger pushbuttons



**GN229**

Elektrodenhandgriff, mit Doppelfingertastern  
Electrode handle, with two finger pushbuttons

passend für Geräte von Aesculap, ACMI, Berchtold, Martin  
suitable for devices from Aesculap, ACMI, Berchtold, Martin

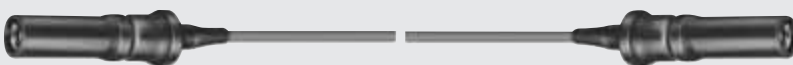

**GN203-GN205**

Kabel für Elektrodenhandgriff  
Cable for electrode handle

GN203	GN205
3,5 m	5,0 m



MILLIMETERS

# Elektrochirurgie – Electro Surgery

Mikro-Chirurgie

Micro Surgery

MONOPOLAR

GK



ø 1,7 mm  
diam. 1.7 mm

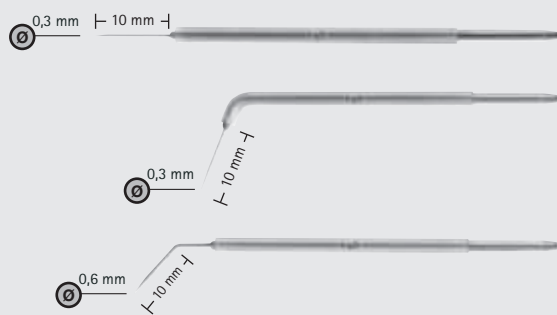

**GK301R-GK305R**

Nadelelektroden  
Needle electrodes

**GK301R**

**GK303R**

**GK305R**

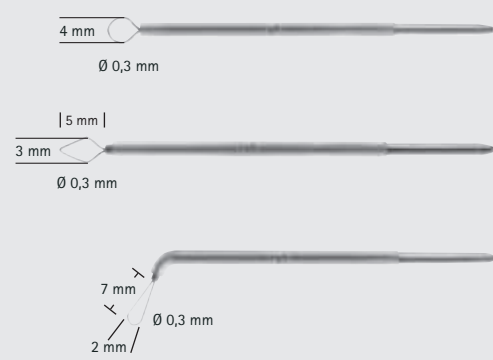

**GK307R-GK315R**

Schlingenelektroden  
Loop electrodes

**GK307R**

**GK310R**

**GK315R**



**GK320R-GK321R**

Kugelelektroden  
Ball electrodes

**GK320R**

**GK321R**

**GK680R**

Behälter mit Deckel  
Container with lid

**GK681R**

Ständer für Mikro-Elektroden  
Rack for micro electrodes

**GK683R**

Ständer für Chirurgie-Elektroden  
Rack for surgery electrodes





**Elektrochirurgie – Electro Surgery**  
Schleimhautnadel, Schere, isoliert  
Mucosa Needle, Scissors, Insulated

**MONOPOLAR**

**GK**



ABBEY

**OL189R**

Schleimhautnadel  
Mucosa needle



**BC608R**

Schere, isoliert  
Scissors, insulated  
200 mm, 8'''

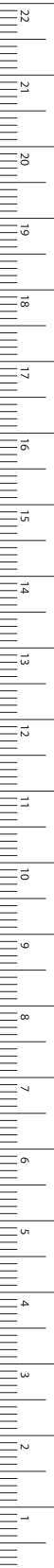

MILLIMETERS

# Elektrochirurgie – Electro Surgery

Pinzetten, isoliert  
Forceps, Insulated

MONOPOLAR

GK

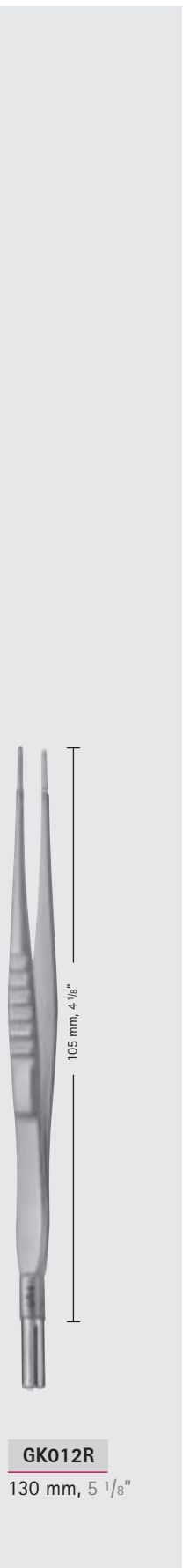

**GK012R**  
130 mm, 5 1/8"

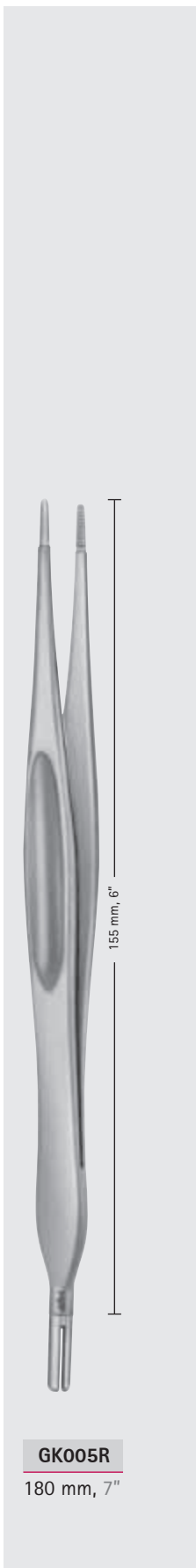

**GK005R**  
180 mm, 7"

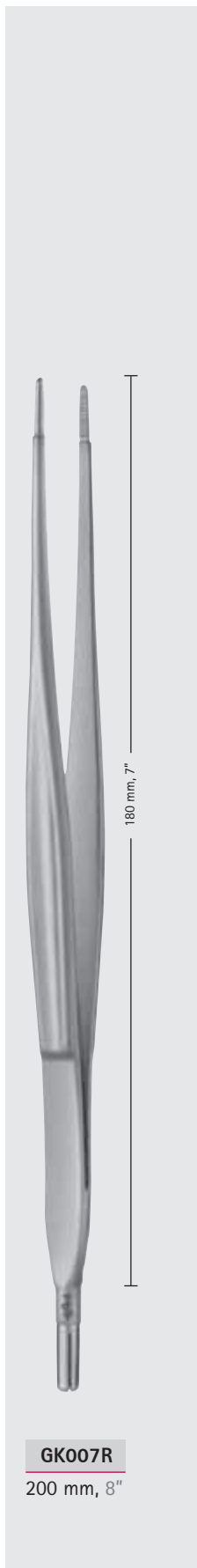

**GK007R**  
200 mm, 8"

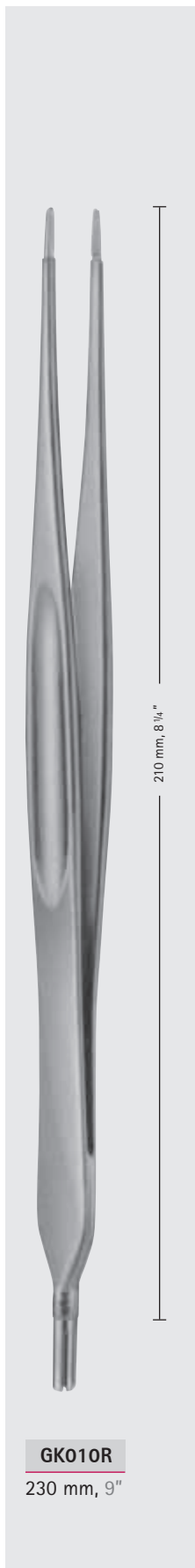

**GK010R**  
230 mm, 9"

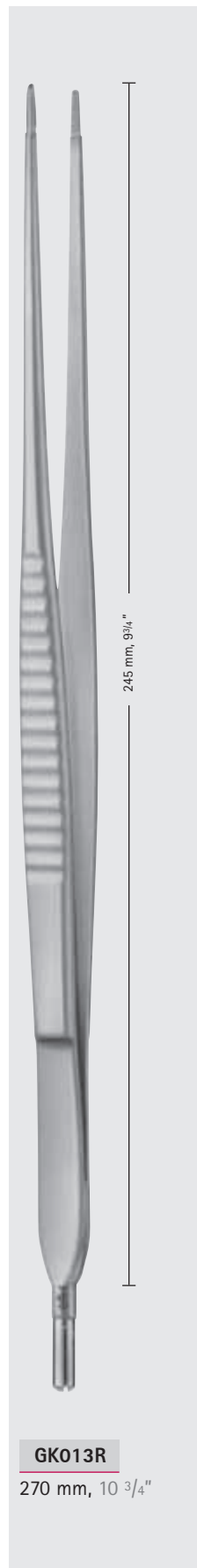

**GK013R**  
270 mm, 10 3/4"



**GK033R**  
350 mm, 14"





**Elektrochirurgie – Electro Surgery**  
 Pinzetten, isoliert  
 Forceps, Insulated

**MONOPOLAR**



**GK**

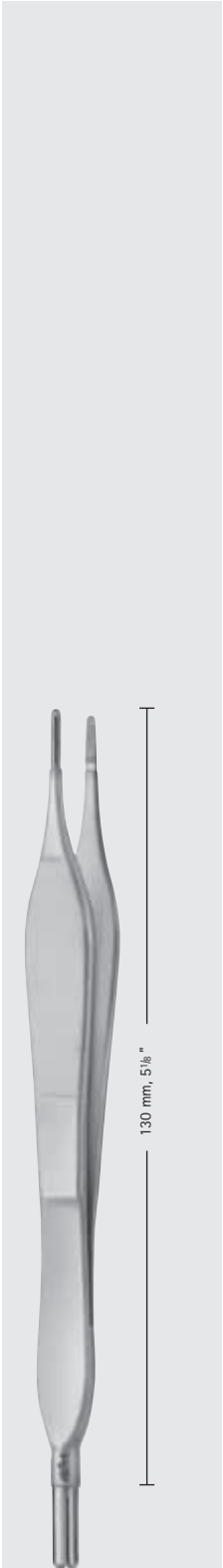

130 mm, 5 1/8"

**ADSON**  
**GK015R**  
 150 mm, 6"

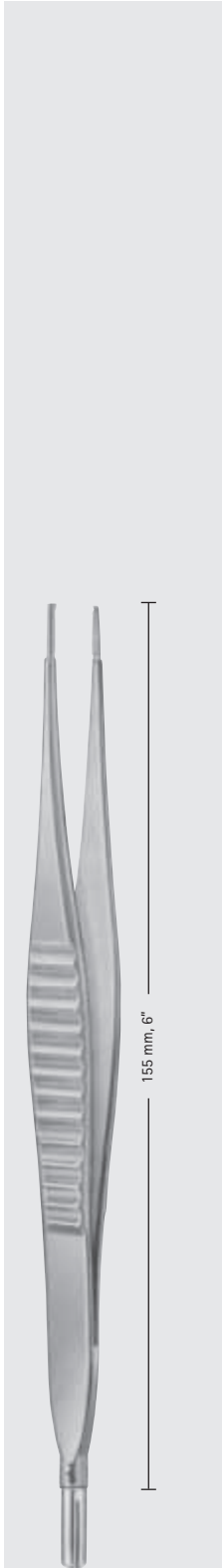

155 mm, 6"

**GILLES**  
**GK006R**  
 1 x 2 Zähne  
 1 x 2 teeth  
 170 mm, 6 3/4"

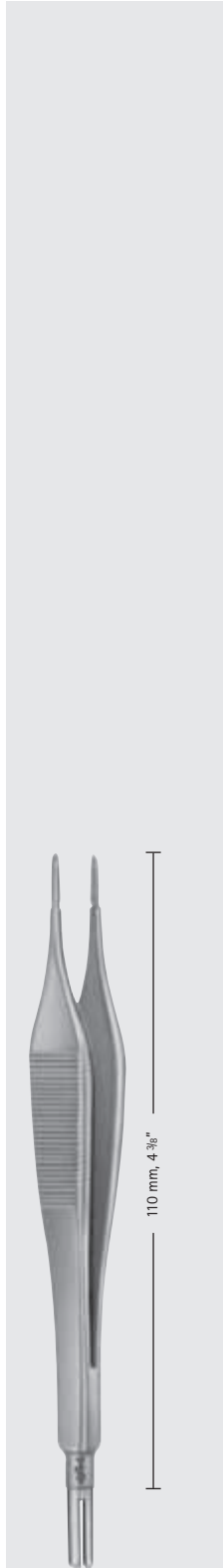

110 mm, 4 3/8"

**TURNER**  
**GK008R**  
 130 mm, 5 1/8"

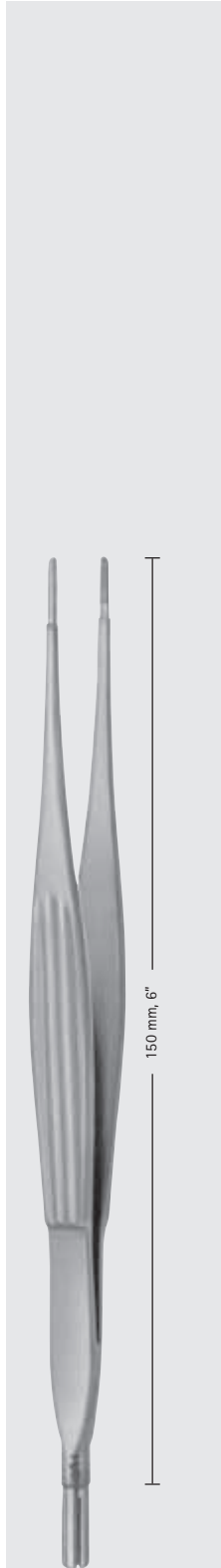

150 mm, 6"

**MC INDOE**  
**GK009R**  
 175 mm, 7"

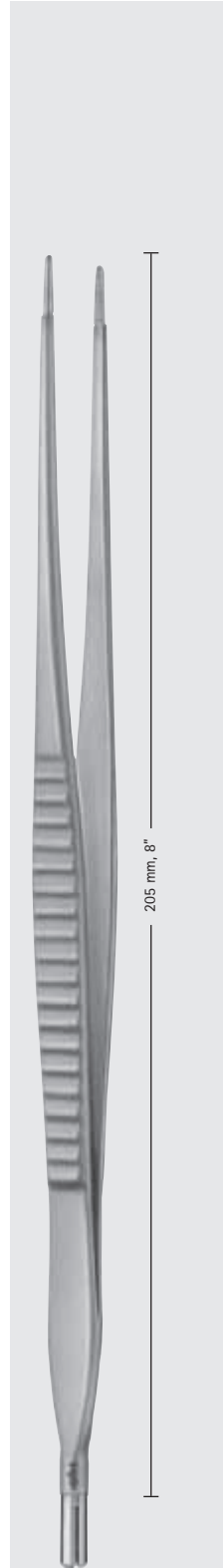

205 mm, 8"

**WAUGH**  
**GK016R**  
 230 mm, 9"



205 mm, 8"

**WAUGH**  
**GK017R**  
 1 x 2 Zähne  
 1 x 2 teeth  
 230 mm, 9"

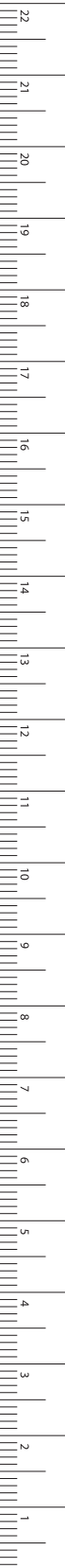

MILLIMETERS

# Elektrochirurgie – Electro Surgery

Pinzetten, isoliert  
Forceps, Insulated

MONOPOLAR

GK



REMINGTON-HOBB

**GK737R**

250 mm, 10"

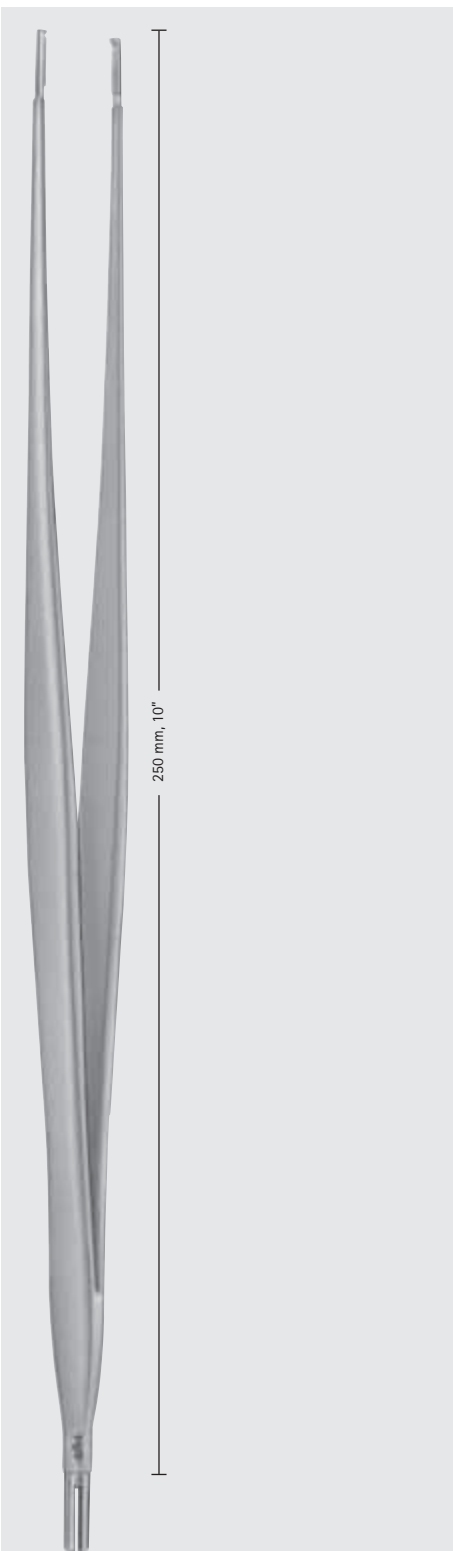

REMINGTON-HOBB

**GK738R**

1 x 2 Zähne

1 x 2 teeth

270 mm, 10 <sup>3</sup>/<sub>4</sub>"

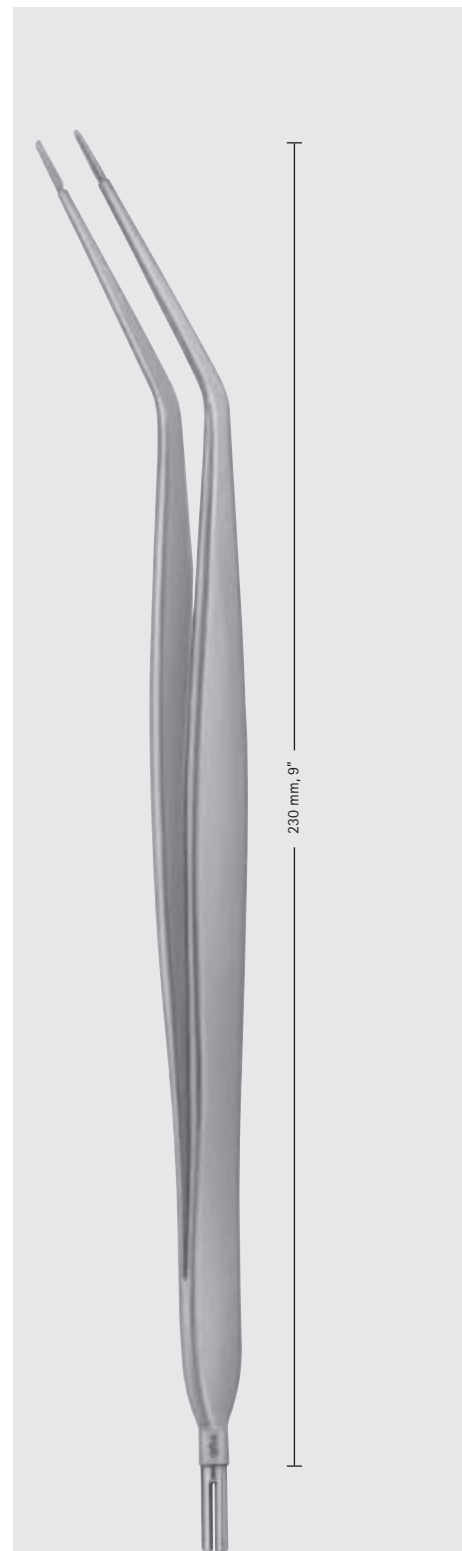

REMINGTON-HOBB

**GK739R**

250 mm, 10"



**Elektrochirurgie – Electro Surgery**  
 Pinzetten, isoliert  
 Forceps, Insulated

**MONOPOLAR**

**AIRAUMATA®**

**GK**



BD852R	BD853R	BD854R
200 mm	240 mm	300 mm
8"	9 1/2"	12"

Anatomische Pinzette  
 Dissecting Forceps



BD855R	BD856R	BD857R
200 mm	240 mm	300 mm
8"	9 1/2"	12"

1 x 2 Zähne  
 1 x 2 teeth



BD858R	BD859R	BD860R
200 mm	240 mm	300 mm
8"	9 1/2"	12"

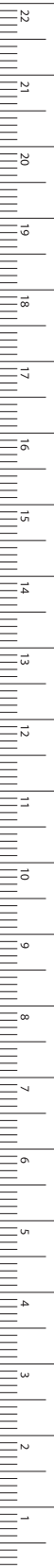

MILLIMETERS

# Elektrochirurgie – Electro Surgery

Klemmen, isoliert  
Forceps, Insulated

MONOPOLAR



GK

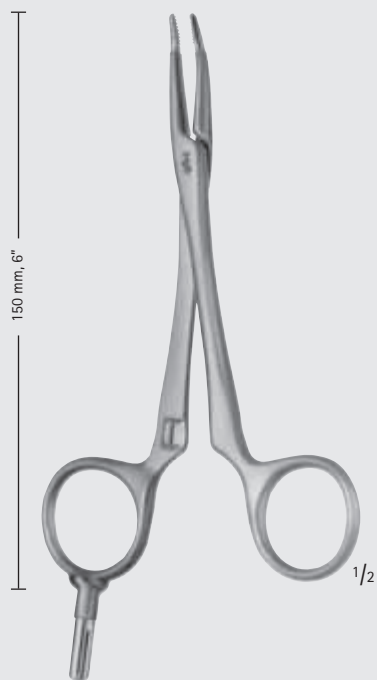

RICHES

**BH353R**

175 mm, 7"

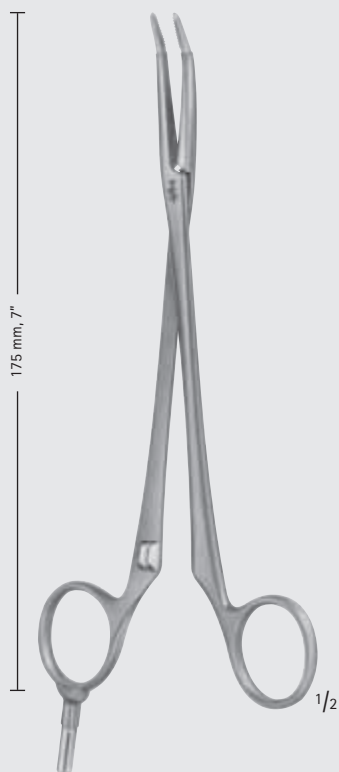

RICHES

**BH354R**

200 mm, 8"

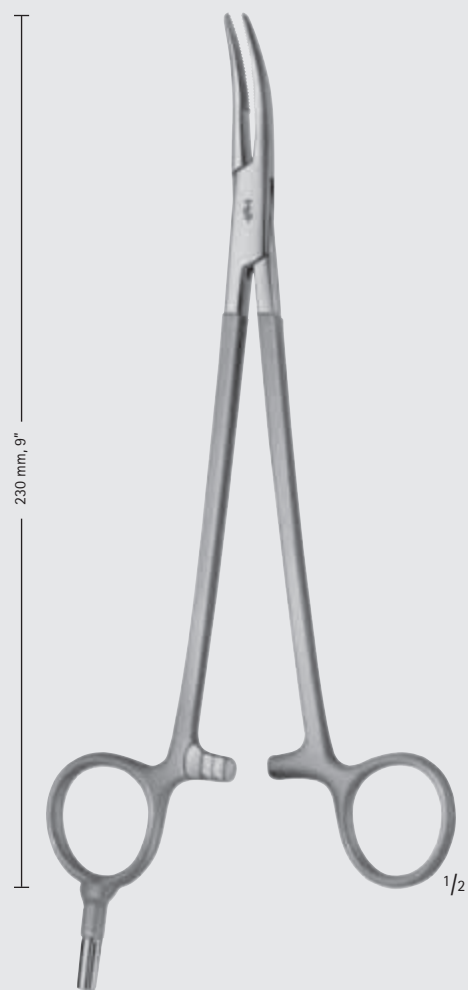

WILSON-HEY

**BH243R**

255 mm, 10"



## Elektrochirurgie – Electro Surgery

Koagulations-Absaugkanülen  
Coagulation Suction Cannula

GK

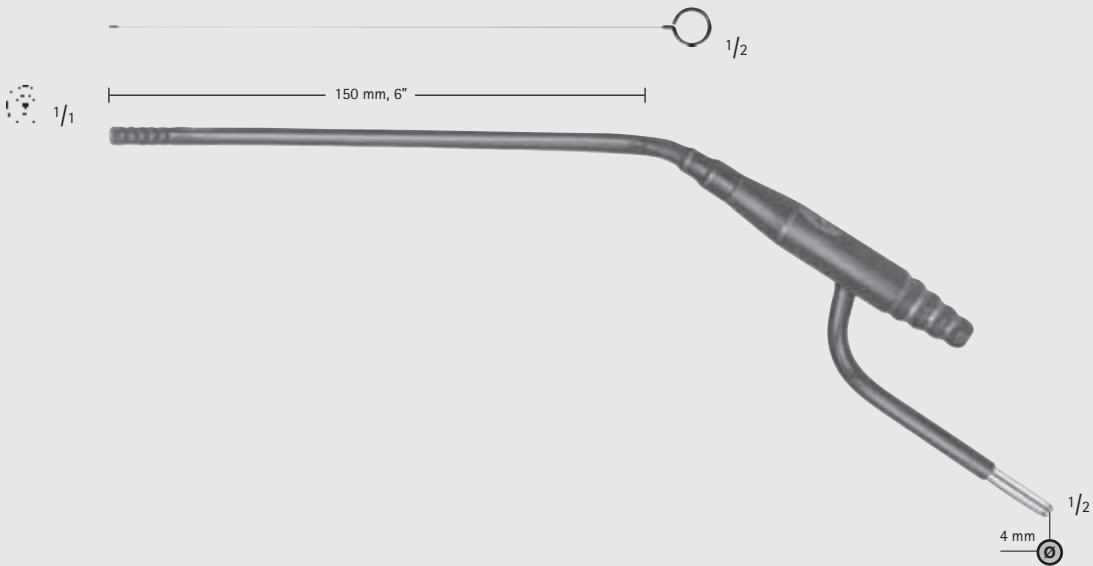

LANDOLT

**GK550**

Koagulations-Absaugkanüle mit Mandrin  
Coagulation suction cannula with mandrel

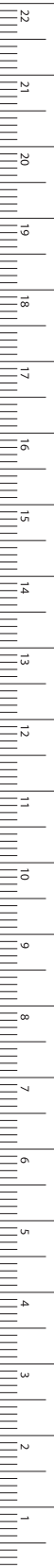

MILLIMETERS

# Elektrochirurgie – Electro Surgery

Anschlusskabel  
Connecting Cables

MONOPOLAR

GK



Geräteseite - Hersteller  
On the equipment side - Manufacturer

Instrumentenseite  
On the instrument side

**GN202**

3,5 m

Aesculap  
ACMI  
Berchtold  
Martin



**GN204**

3,5 m



**GK239**

3,5 m

Erbe ACC/ICC



**GN216**

Aesculap

Monopolar Adapter  
Monopolar adapter



Erbe, Storz

**GK245**

3,5 m

Erbe T



**GK180**

3,5 m



**GK246**

3,5 m

ACMI  
Conmed  
Erbe ICC intern.  
Eschmann  
Valleylab  
US-Norm



**GK181**

3,5 m



## BIPOLAR



Aesculap Rundstecker  
Aesculap round pin connector

schwarz isoliert  
black insulation



**GK690R**  
120 mm, 4 3/4"



**GK720R-GK722R**  
160 mm, 6 1/4"



**GK723R**  
160 mm, 6 1/4"

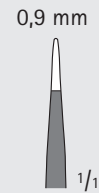

**GK730R**  
200 mm, 8"

Drahtbürstchen zum Reinigen von Koagulationspinzetten und Koagulationselektroden.  
Wire brush for cleaning coagulation forceps and coagulation electrodes.



**GK299**

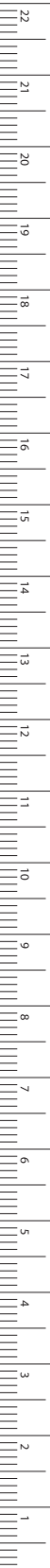

# Elektrochirurgie – Electro Surgery

Mikro- und Laborpinzetten

Micro and Laboratory Forceps

BIPOLAR



Euro Flachstecker  
Euro tab connector

GK

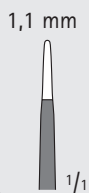

**GK809R**

scharf  
sharp  
125 mm, 5"

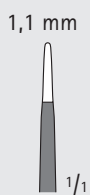

**GK807R**

fein  
delicate  
175 mm, 7"

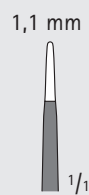

**GK808R**

fein  
delicate  
220 mm, 8 3/4"





**Elektrochirurgie – Electro Surgery**  
 Standard Koagulationspinzetten  
 Standard Coagulation Forceps

**BIPOLAR**



Aesculap Flachstecker  
 Aesculap tab connector

**GK**

0,6 mm 0,9 mm  
 $\frac{1}{1}$   $\frac{1}{1}$

**GK700R GK701R**

**GK700R-GK701R**  
 160 mm, 6 1/4"

0,9 mm  
 $\frac{1}{1}$

**GK703R**  
 200 mm, 8"

0,9 mm  
 $\frac{1}{1}$

**GK711R**  
 160 mm, 6 1/4"

0,9 mm  
 $\frac{1}{1}$

**GK713R**  
 200 mm, 8"



MILLIMETERS

# Elektrochirurgie – Electro Surgery

Standard Koagulationspinzetten

Standard Coagulation Forceps

BIPOLAR

GK



Aesculap Flachstecker  
Aesculap tab connector



0,6 mm  
1/1

**GK595R**

120 mm, 4 3/4"



0,3 mm  
1/1

**GK596R**

145 mm, 5 3/4"



0,6 mm  
1/1

**GK597R**

110 mm, 4 3/8"



## Elektrochirurgie – Electro Surgery

### Sintram Koagulationspinzetten

### Sintram Coagulation Forceps

## BIPOLAR



Aesculap Flachstecker  
Aesculap tab connector



Bipolare Koagulationspinzette mit Sintram-Spitzen verhindern das Ankleben der koagulierten Gefäße.  
Bipolar coagulation forceps with Sintram tips do not stick to coagulated vessels.

GK

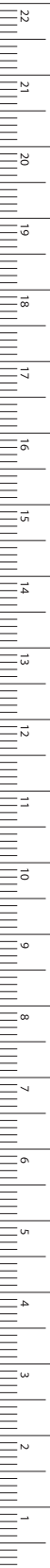

**GK604R**  
160 mm, 6 1/4"  
gerade  
straight

**GK605R**  
185 mm, 7 1/4"  
gerade  
straight

**GK606R**  
200 mm, 8"  
gerade  
straight

**GK624R**  
160 mm, 6 1/4"  
abgewinkelt  
angled

**GK625R**  
200 mm, 8"  
abgewinkelt  
angled

# Elektrochirurgie – Electro Surgery

Pinzette, vollisolierte Spitze

Forceps, Fully Insulated Tip

BIPOLAR

GK



Aesculap Flachstecker  
Aesculap tab connector



BARRE

**GK685R**

260 mm,  
10 1/4"



**GK881R**

160 mm,  
6 1/4"



**GK882R**

200 mm,  
8"



**GK883R**

230 mm, 9"



**GK884R**

250 mm,  
10"



**GK885R**

300 mm,  
12"



**GK886R**

160 mm,  
6 1/4"



# BIPOLAR

## Elektrochirurgie – Electro Surgery Pinzette, teilisolierte Spitze Forceps, Partly Insulated Tip



Aesculap Flachstecker  
Aesculap tab connector

GK



1/2

**GK891R**

160 mm,  
6 1/4"



1/2

**GK892R**

200 mm,  
8"



1/2

**GK893R**

230 mm,  
9"



1/2

**GK894R**

250 mm,  
10"



1/2

**GK895R**

300 mm,  
12"



1/2

**GK896R**

160 mm,  
6 1/4"

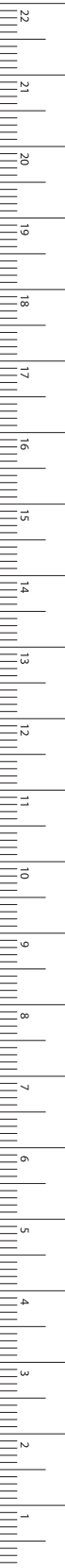

MILLIMETERS

# Elektrochirurgie – Electro Surgery

Präparierscheren  
Dissecting Scissors

BIPOLAR

GK

*biopJet*



METZENBAUM

**BC685R-BC686R**

180 mm, 7"



METZENBAUM

**BC687R-BC688R**

230 mm, 9"



METZENBAUM

**BC689R-BC690R**

280 mm, 11"

Länge  
Length

180 mm

7"

230 mm

9"

280 mm

11"



1/1

Standard-Spitze  
Standard tip

**BC685R**

**BC687R**

**BC689R**



1/1

Feine Spitze  
Fine tip

**BC686R**

**BC688R**

**BC690R**



### Anti Verdreh Kabel

Kabel und Anschlüsse sind so konstruiert, dass sich die Kabel nicht verdrehen können. Dadurch ist gewährleistet, dass die Schere auch nach mehrmaligem Rotieren noch geöffnet werden kann.

### Anti-twist cable

The BiopJet cable and jack are designed and constructed in such a way that the cable cannot become twisted. This means that the scissors can still be opened even after being rotated repeatedly.



## Elektrochirurgie – Electro Surgery

### Klemmen und Handschalter

### Bipolar Forceps and Finger Switches

## BIPOLAR

*bipoJet*



BH686R	BH687R	BH689R
180 mm	230 mm	280 mm
7"	9"	11"



**BH686R-BH689R**

#### Bipolare Handschalter

- ermöglichen die Aktivierung des HF Generators ohne Fußschalter
- verwendbar mit GN640 Nelson deluxe oder der bipolaren Schaltbox GN310

#### Bipolar finger switches

- allows the activation of the HF generator without foot switch
- to be used with GN640 Nelson deluxe or with the bipolar switch box GN310



**GN084**

für BipoJet Schere  
for BipoJet scissors



**GN086**

für BipoJet Klemmen  
for BipoJet clamps

#### Nelson Bibox - Bipolare Schaltbox

- ermöglicht den Anschluss der Handschalter GN084 und GN086 an HF Geräte anderer Hersteller
- es können bis zu zwei bipolare Instrumente mit Hand- oder Fußschalter betrieben werden

#### Nelson Bibox - Bipolar switchbox

- allows the connection of the finger switches GN084 and GN086 to HF units of other suppliers
- allows the use of two bipolar instruments parallelly with finger or foot switch activation



305 x 75 x 305 mm

**GN310**

Nelson Bibox  
Bipolare Schaltbox  
Nelson Bibox  
Bipolar switchbox

Weitere Informationen finden Sie in unserem Prospekt C304.  
For further details see brochure No. C304.

**GK**



MILLIMETERS

# Elektrochirurgie – Electro Surgery

Anschlusskabel  
Connecting Cables

BIPOLAR

GK



Geräteseite – Hersteller  
On the equipment side – Manufacturer

Instrumentenseite  
On the instrument side

## GN080

5 m

ACMI  
Codman  
Conmed  
Erbe international  
Olympus  
Valleylab

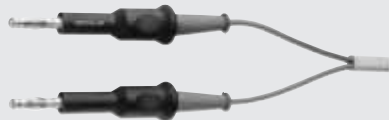

## GN081

5 m

Aesculap  
Berchthold  
Martin  
R. Wolf



## GN082

5 m

Erbe  
Storz



## GN083

5 m

Für Aesculap  
Elektrochirurgie  
Geräte:  
For Aesculap  
Generators:  
GK020  
GK021  
GK030  
GK034  
GK050  
GK051



## GN085

5 m

Aesculap  
Bowa  
EMC  
Lamidey  
Söring  
Valleylab







# Elektrochirurgie – Electro Surgery

## Anschlusskabel Connecting Cables

### BIPOLAR

Geräteseite - Hersteller  
On the equipment side - Manufacturer

Instrumentenseite  
On the instrument side

**GN073**

3,5 m

**GN077**

5,0 m

**GN076**

3,5 m

**GN078**

5,0 m

**GN074**

3,5 m

Aesculap  
ACMI  
Berchtold  
Martin  
Wolf

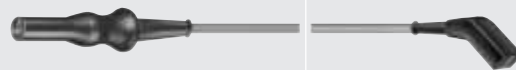

 Aesculap  
Flachstecker  
tab connector

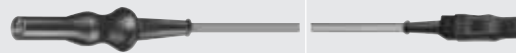

 Euro-Flachstecker  
Euro tab connector

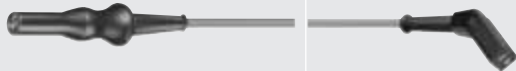

 Aesculap  
Rundstiftstecker  
Round pin connector

**GK200**

3,5 m

**GK183**

3,5 m

**GK210**

3,5 m

Aesculap  
ACMI  
Codman  
Conmed  
Olympus  
Valleylab



 Aesculap  
Flachstecker  
tab connector



 Euro-Flachstecker  
Euro tab connector



 Aesculap  
Rundstiftstecker  
Round pin connector

**XF830**

3,5 m

**GK216**

3,5 m

**GK213**

5 m

**GK185**

3,5 m

**GK188**

5,0 m

Erbe  
Storz

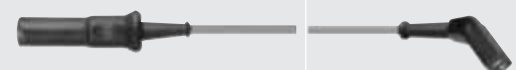

 Aesculap  
Rundstiftstecker  
Round pin connector

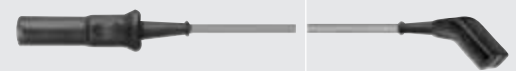

 Aesculap  
Flachstecker  
tab connector

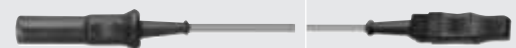

 Euro-Flachstecker  
Euro tab connector

**GN217**

Aesculap

Bipolar Adapter  
Bipolar adapter



Erbe, Storz

**GK**

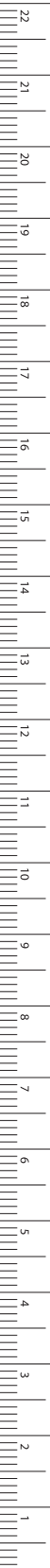

MILLIMETERS

# Elektrochirurgie – Electro Surgery

## Anschlusskabel Connecting Cables

**BIPOLAR**

**GK**



Geräteseite - Hersteller  
On the equipment side - Manufacturer

Instrumentenseite  
On the instrument side

**GK217**

3,5 m

Codman



▬ Aesculap  
Flachstecker  
tab connector

**GK193**

3,5 m

Aesculap  
Bowa  
EMC  
Lamidey  
Söring  
Valleylab



▬ Aesculap  
Flachstecker  
tab connector

**GK194**

3,5 m



▭ Euro-Flachstecker  
Euro tab connector

**GK202**

3,5 m

AESCULAP  
GK020  
GK021  
GK030  
GK034  
GK050  
GK051

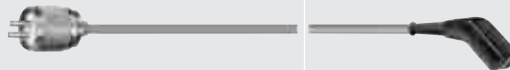

▬ Aesculap  
Flachstecker  
tab connector

**GK212**

3,5 m

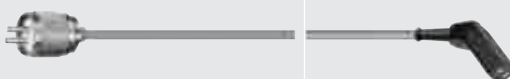

●● Aesculap  
Rundstiftstecker  
Round pin connector

### Single Use

**GK211**

3,5 m

PAK =  
Packung à  
10 Stück  
PAK =  
Package of  
10 pieces

AESCULAP  
ACMI  
Codman  
Conmed  
Olympus  
Valleylab

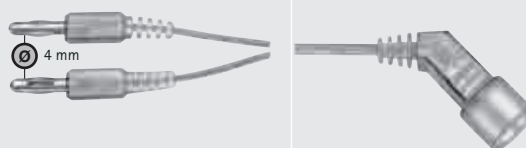

▬ für Pinzetten mit  
Aesculap-Flach-  
stecker und  
●● Rundstiftstecker  
for forceps with  
Aesculap tab con-  
nector and round  
pin connector



## Elektrochirurgie – Electro Surgery Zubehör Accessoir

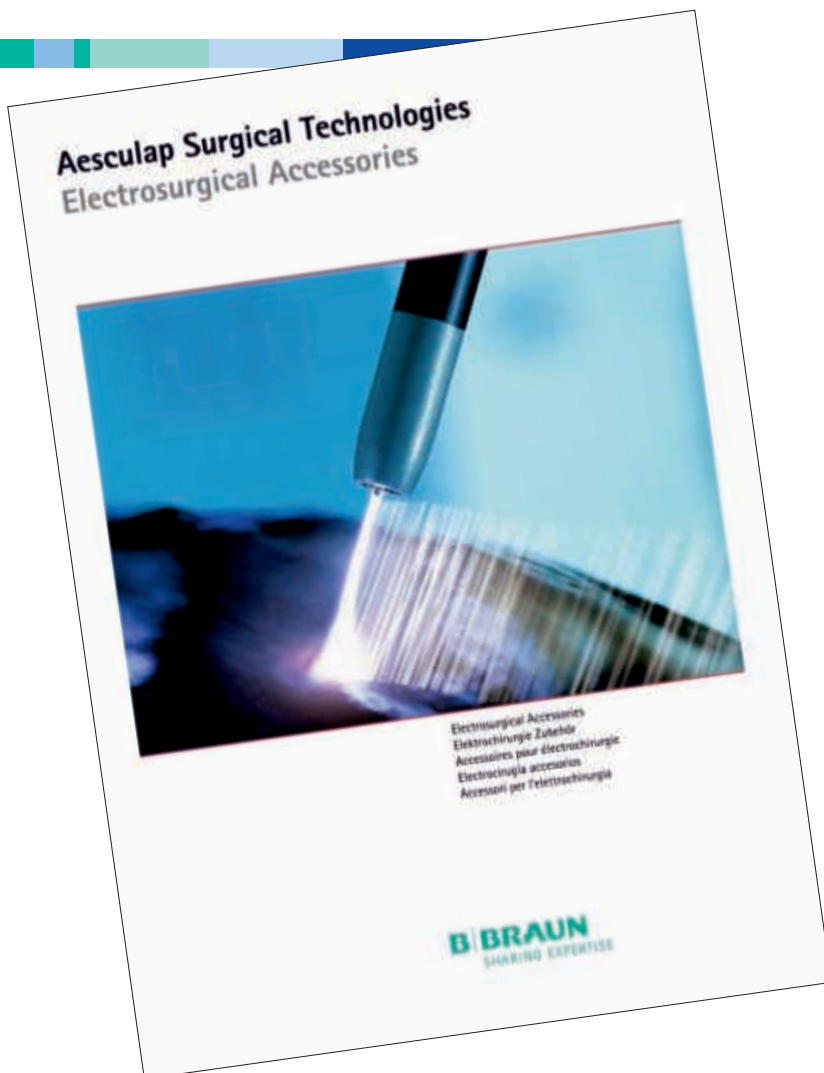

Weitere Informationen finden Sie in unserem Prospekt **C30481**.

For further details see brochure No. **C30481**.

### Inhalt C30481 „Elektrochirurgie Zubehör“ Table of Contents C30481 "Electrosurgical Accessories"

- ⌘ Geräte und Zubehör  
Units and Accessories
- ⌘ Monopolares Equipment für die offene Chirurgie  
Monopolar equipment for open surgery
- ⌘ Bipolares Equipment – Koagulationspinzetten  
Bipolar equipment – Coagulation forceps
- ⌘ Neutralelektroden  
Neutral electrodes
- ⌘ Kabel und Adapter  
Cables and Adapter
- ⌘ Elektrochirurgie in der Endoskopie  
Electrosurgical Endoscopy

GK

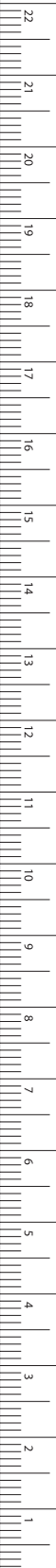

MILLIMETERS

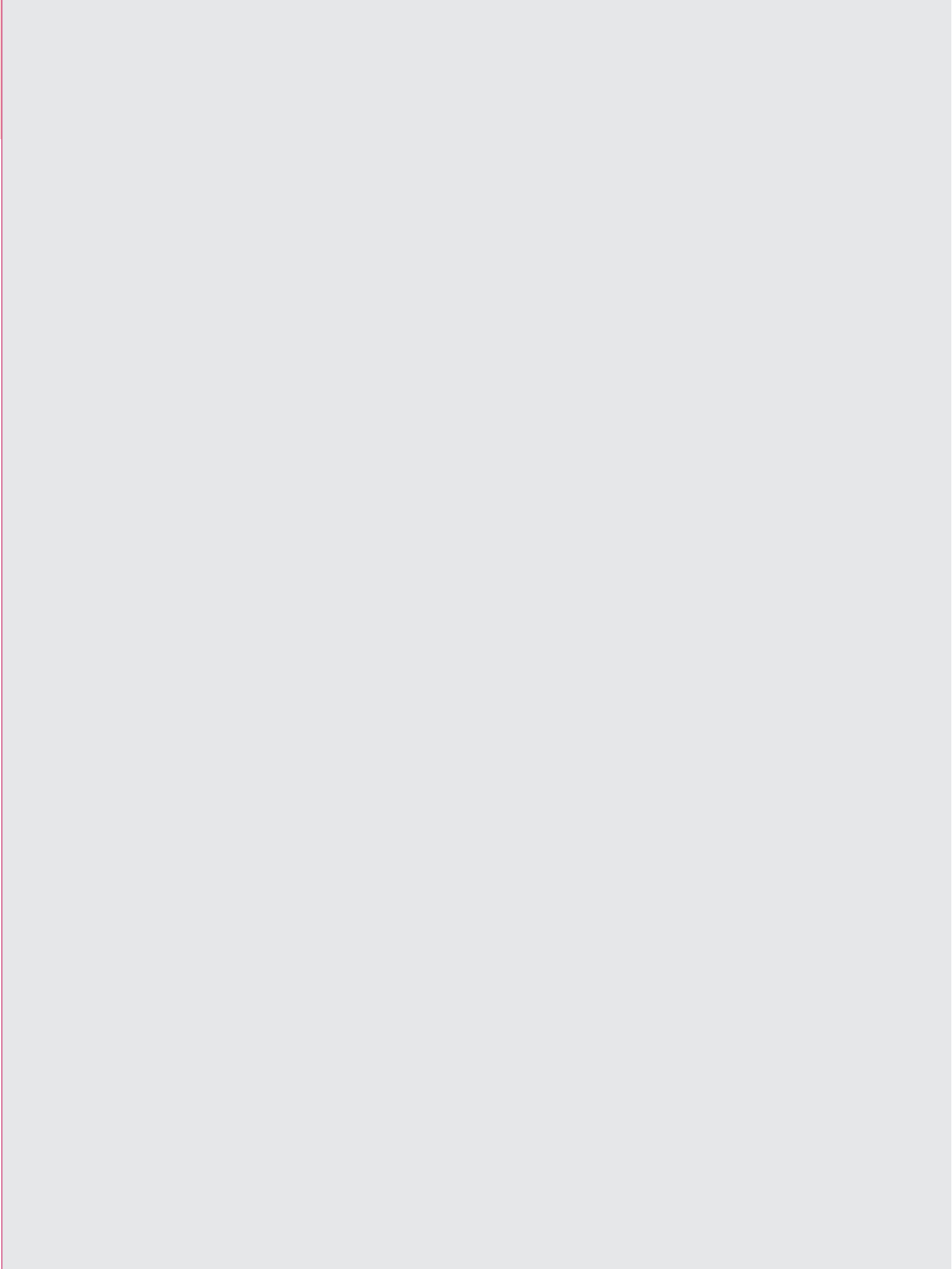

EA



**Abdominale Chirurgie, Magen-, Darm-  
und Rektum-Instrumente**

Abdominal Surgery, Intestinal- and  
Rectal Instruments

# Abdominale Chirurgie – Abdominal Surgery

Darm- und Gewebefasszangen

Intestinal- and Tissue Grasping Forceps

EA



$\frac{1}{1}$   
2 x 3 Zähne, scharf  
2 x 3 teeth, sharp

$\frac{1}{2}$

CHAPUT

**BF300R**

125 mm, 5"

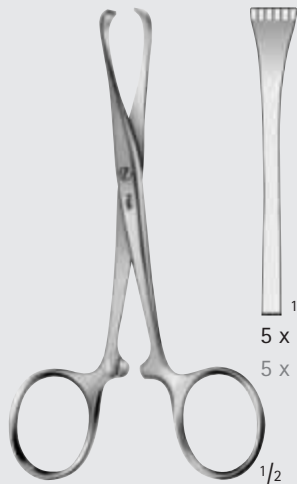

$\frac{1}{1}$   
5 x 6 Zähne, scharf  
5 x 6 teeth, sharp

$\frac{1}{2}$

TUFFIER

**BF301R**

125 mm, 5"

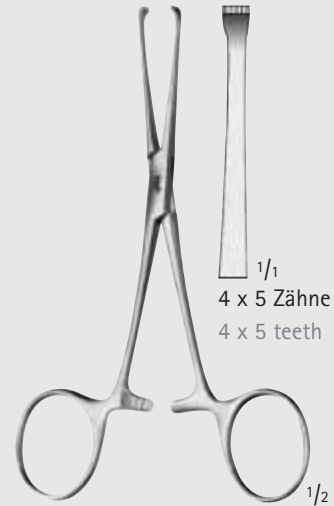

$\frac{1}{1}$   
4 x 5 Zähne  
4 x 5 teeth

$\frac{1}{2}$

BABY-ALLIS

**EA012R**

130 mm, 5  $\frac{1}{8}$ "



$\frac{1}{1}$   
5 x 6 Zähne  
5 x 6 teeth

$\frac{1}{2}$

BOYS-ALLIS

**EA010R**

155 mm, 6"



$\frac{1}{1}$   
9 x 10 Zähne  
9 x 10 teeth

$\frac{1}{2}$

ALLIS-ADAIR

**MD568**

160 mm, 6  $\frac{1}{4}$ "



## Abdominale Chirurgie – Abdominal Surgery

### Darm- und Gewebefasszangen Intestinal- and Tissue Grasping Forceps

EA



**EA013R**

2 x 3 Zähne  
2 x 3 teeth

**EA014R**

3 x 4 Zähne  
3 x 4 teeth

**EA015R**

4 x 5 Zähne  
4 x 5 teeth

ALLIS

**EA013R-EA015R**

155 mm, 6"

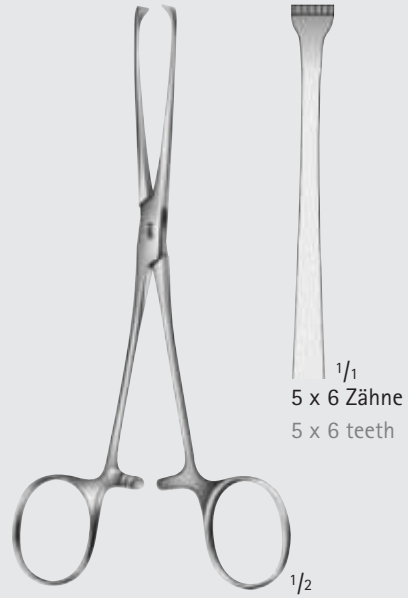

$\frac{1}{2}$

5 x 6 Zähne  
5 x 6 teeth

ALLIS

**EA016R**

155 mm, 6"



**EA017R**

190 mm  
7 1/2"

**EA018R**

255 mm  
10"

ALLIS

**EA017R-EA018R**

5 x 6 Zähne  
zarte Modelle  
5 x 6 teeth  
slendern patterns



$\frac{1}{1}$

ALLIS

**FB938R**

220 mm, 8 3/4"

$\frac{1}{2}$



MILLIMETERS

# Abdominale Chirurgie – Abdominal Surgery

Organ- und Gewebefassungen

Organ- and Tissue Grasping Forceps

EA

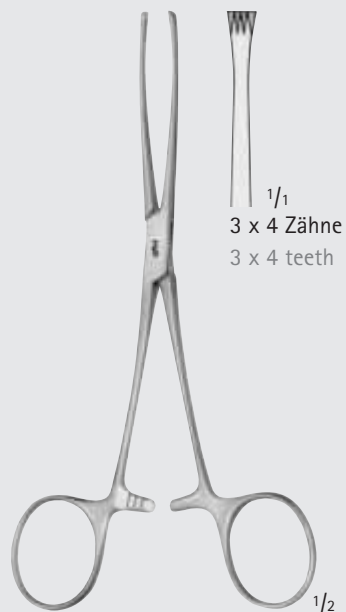
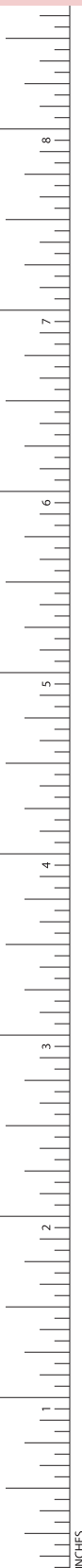

1/1  
3 x 4 Zähne  
3 x 4 teeth

JUDD-ALLIS

**EA025R**

155 mm, 6"



1/1  
3 x 4 Zähne  
3 x 4 teeth

JUDD-ALLIS

**EA026R**

195 mm, 7 3/4"

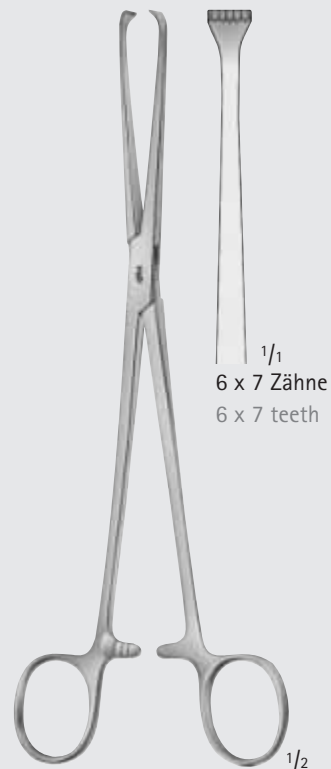

1/1  
6 x 7 Zähne  
6 x 7 teeth

ALLIS-THOMS

**EA020R**

200 mm, 8"

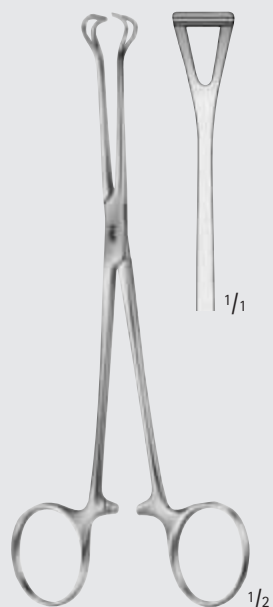

1/1

BABCOCK

**EA030R**

155 mm, 6"



1/1

EA031R	EA032R	EA033R
170 mm	215 mm	200 mm
6 3/4"	8 1/2"	8"

BABCOCK

**EA031R-EA033R**



1/1

BABCOCK

**FB934R**

220 mm, 8 3/4"





**Abdominale Chirurgie – Abdominal Surgery**  
 Darmfazzangen  
 Intestinal Grasping Forceps

**EA**

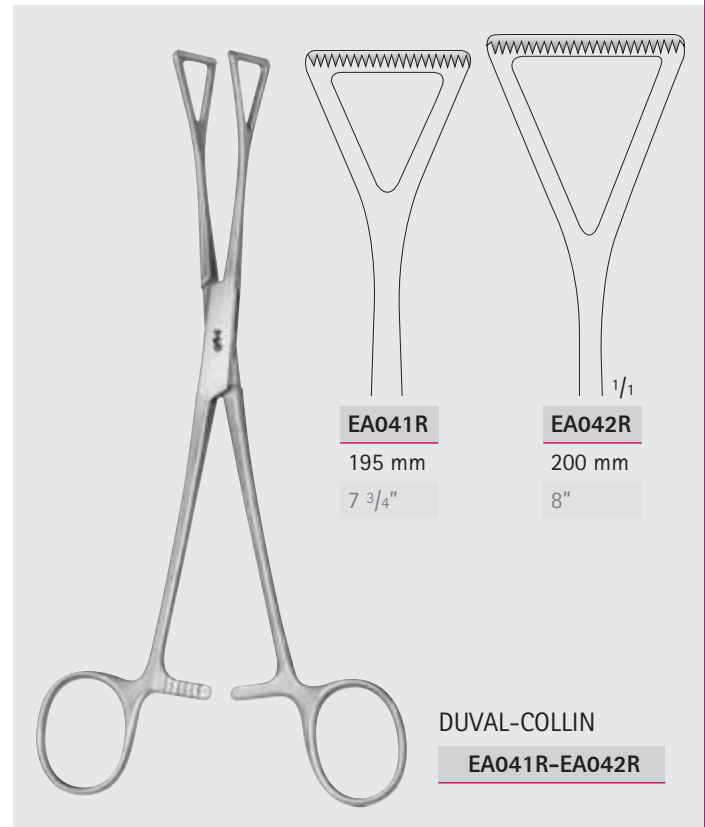
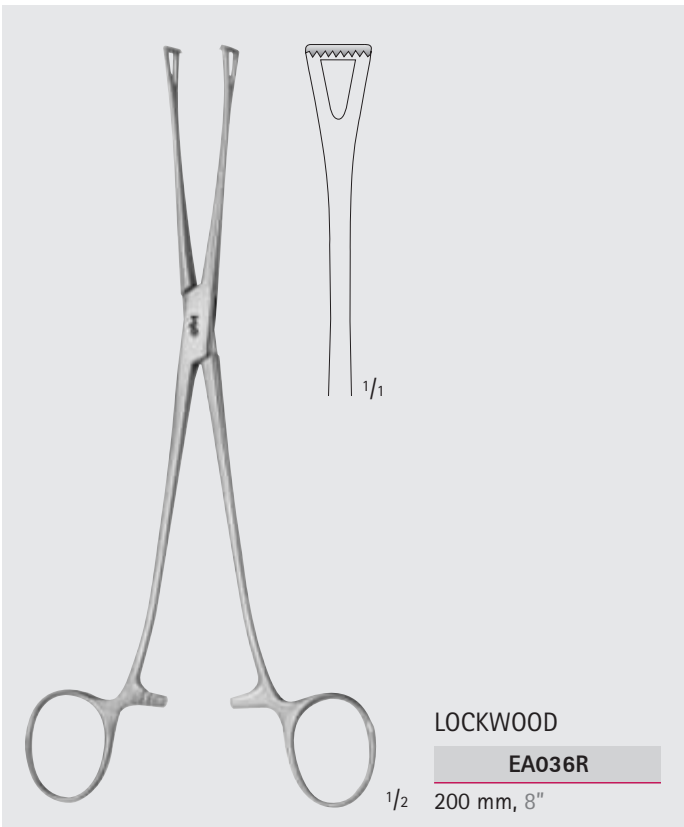
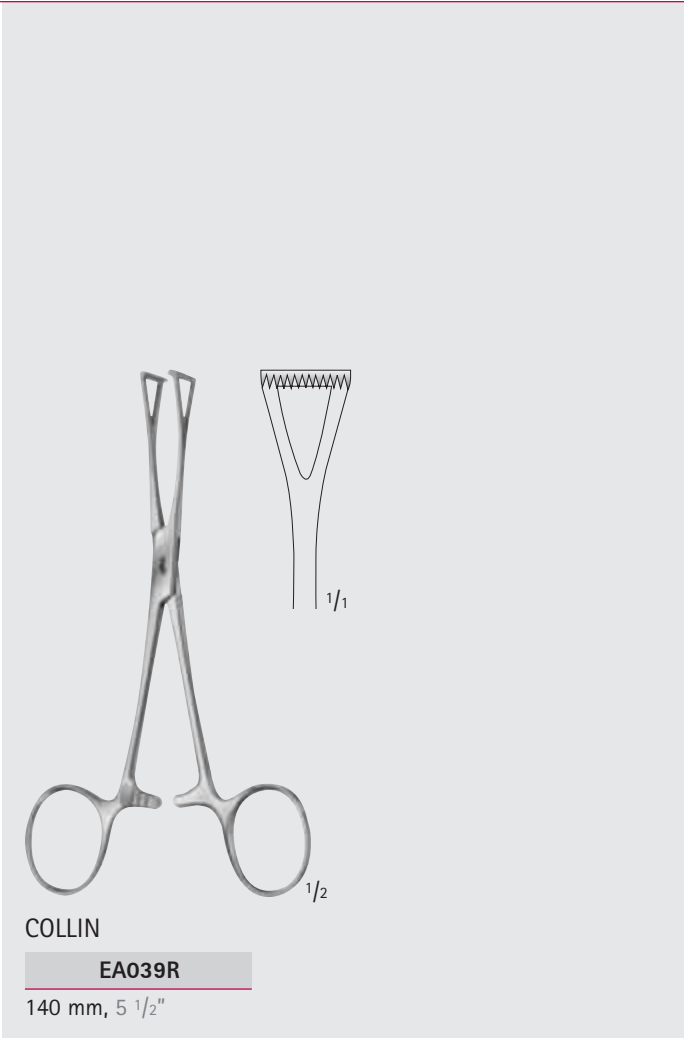
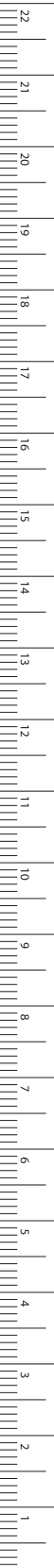

# Abdominale Chirurgie – Abdominal Surgery

Darmfazzangen

Intestinal Grasping Forceps

EA

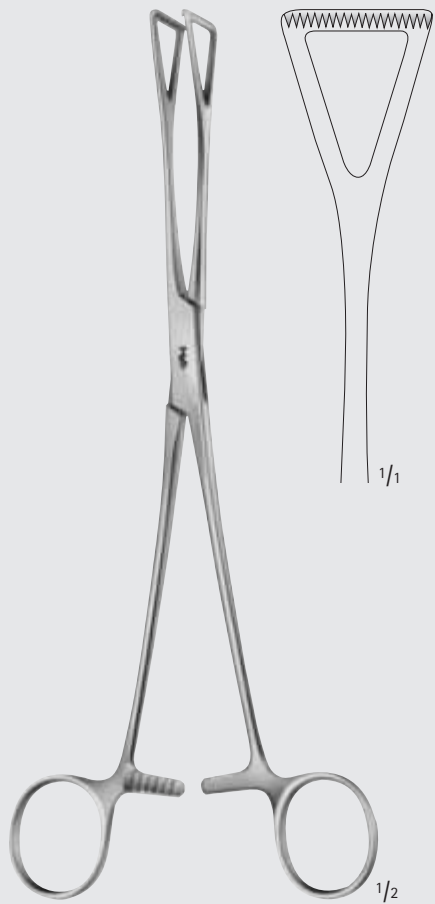
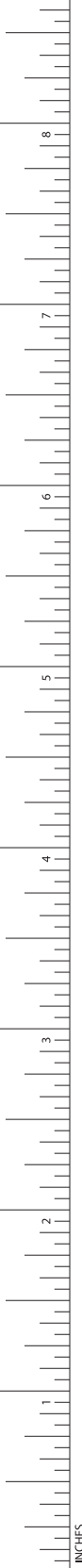

DUVAL

**FB930R**

230 mm, 9"

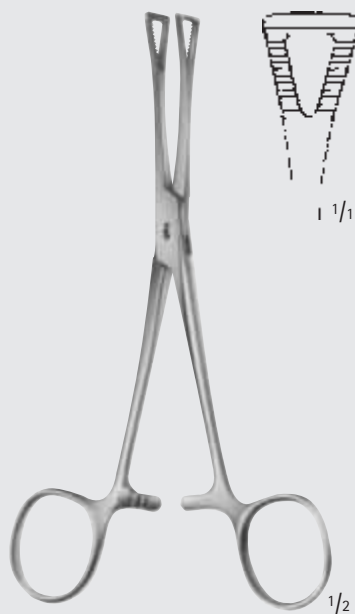

PENNINGTON

**BH902R**

155 mm, 6"



PENNINGTON

**EA037R**

200 mm, 8"



## Abdominale Chirurgie – Abdominal Surgery

### Organ-, Gewebefasszangen und Pinzetten

### Organ-, Tissue Grasping Forceps and Dissecting Forceps

EA

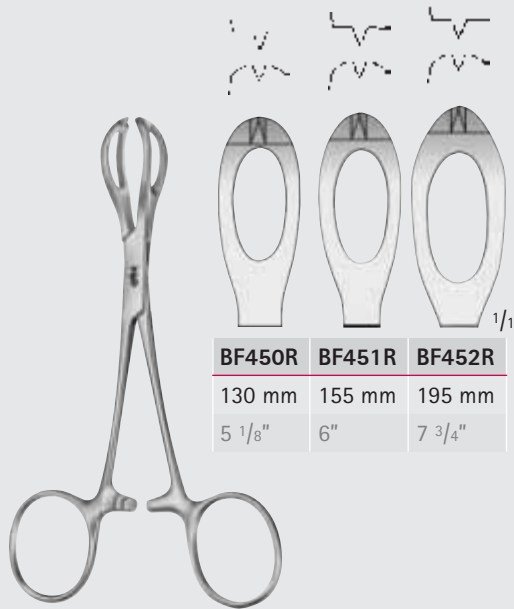

BF450R	BF451R	BF452R
130 mm	155 mm	195 mm
5 1/8"	6"	7 3/4"

LANE

**BF450R-BF452R**



WILLIAMS

**EA028R**

160 mm, 6 1/4"



DENIS-BROWNE

**EA027R**

190 mm, 7 1/2"



DUVAL

**BD820R**

140 mm, 5 1/2"



WANGENSTEIN

**BD171R-BD173R**

BD171R	BD173R
150 mm	230 mm
6"	9"



STILLE-BARRAYA

**BD725R-BD727R**

BD725R	BD726R	BD727R
180 mm	200 mm	250 mm
7"	8"	10"
3 x 4 Zähne 3 x 4 teeth	3 x 4 Zähne 3 x 4 teeth	4 x 5 Zähne 4 x 5 teeth



MILLIMETERS

# Abdominale Chirurgie – Abdominal Surgery

Organ-, Gewebe- und Darmfasszangen

Organ-, Tissue and Intestinal Grasping Forceps

TRAUMATA®

EA



EA092R	EA095R	EA096R	EA097R	EA099R	EA101R	EA100R
155 mm	200 mm	220 mm	255 mm	300 mm	350 mm	295 mm
6"	8"	8 3/4"	10"	12"	14"	11 3/4"

ALLIS

EA092R-EA101R

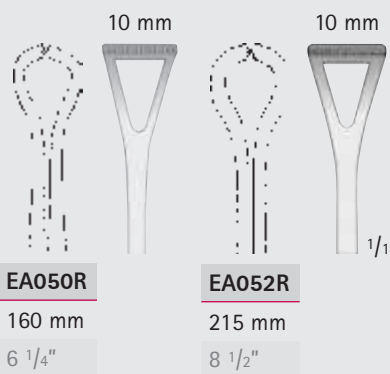

**EA050R**  
160 mm  
6 1/4"

**EA052R**  
215 mm  
8 1/2"

BABCOCK

EA050R-EA052R

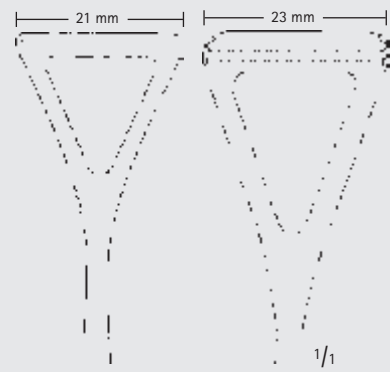

**EA061R**  
195 mm  
7 3/4"

**EA062R**  
230 mm  
9"

COLLIN

EA061R-EA062R



AIRAUMATA®

**Abdominale Chirurgie – Abdominal Surgery**  
Organ-, Gewebe- und Darmfazzangen  
Organ-, Tissue and Intestinal Grasping Forceps

EA



BABCOCK

**FB936R**

220 mm, 8 3/4"



BABCOCK

**MD470**

240 mm, 9 1/2"

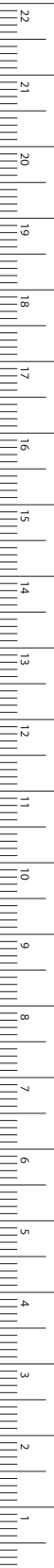

MILLIMETERS

## Abdominale Chirurgie – Abdominal Surgery

Ultra-Light Pinzetten, Pinzetten

Ultra-Light-Forceps, Dissecting Forceps

ARAUMATA®

EA

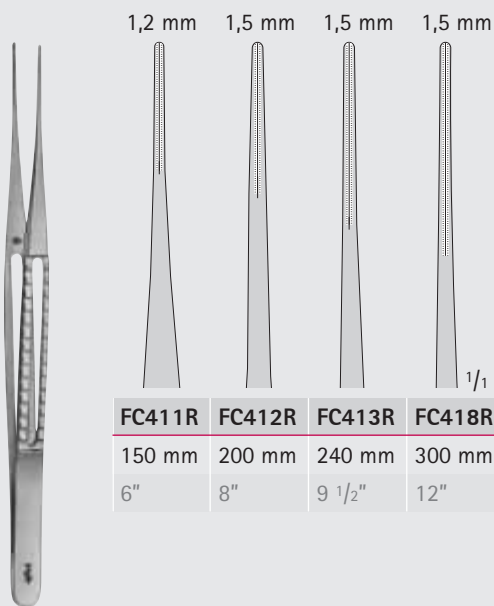

FC411R	FC412R	FC413R	FC418R
150 mm	200 mm	240 mm	300 mm
6"	8"	9 1/2"	12"

### FC411R-FC418R

Ultra-Light Pinzetten  
Ultra-Light-Forceps

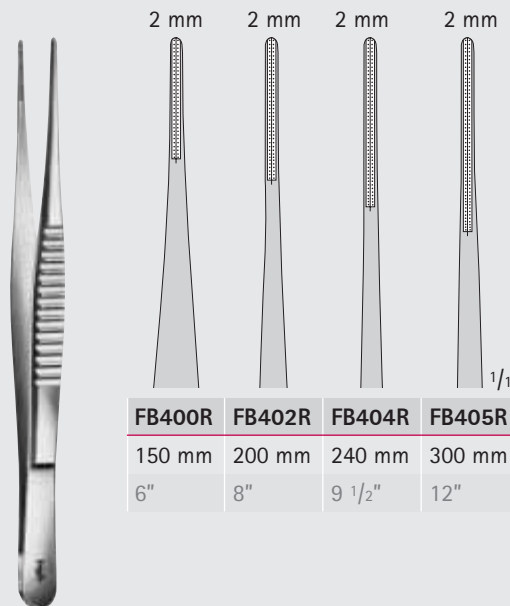

FB400R	FB402R	FB404R	FB405R
150 mm	200 mm	240 mm	300 mm
6"	8"	9 1/2"	12"

DE BAKEY

### FB400R-FB405R

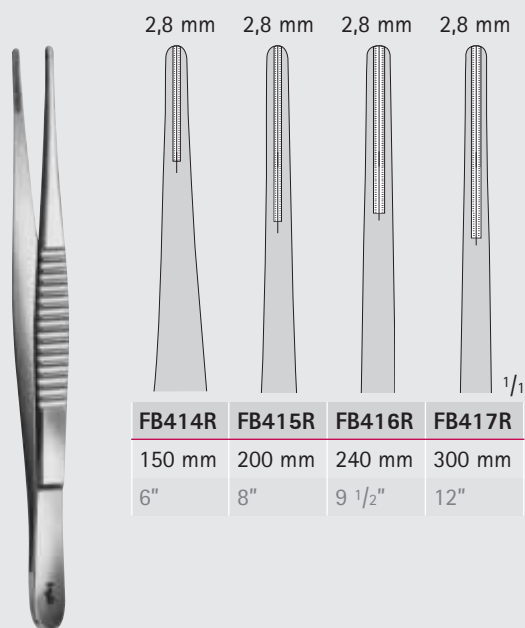

FB414R	FB415R	FB416R	FB417R
150 mm	200 mm	240 mm	300 mm
6"	8"	9 1/2"	12"

DE BAKEY

### FB414R-FB417R

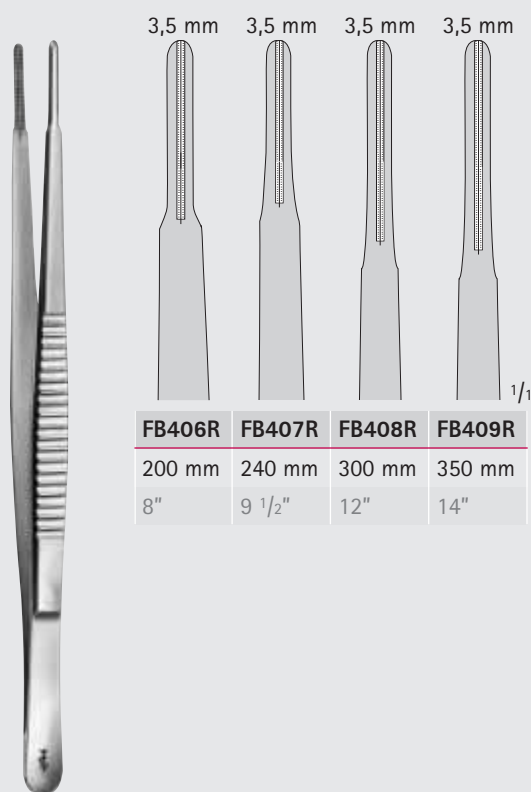

FB406R	FB407R	FB408R	FB409R
200 mm	240 mm	300 mm	350 mm
8"	9 1/2"	12"	14"

DE BAKEY

### FB406R-FB409R

350 mm, 14"



**Abdominale Chirurgie – Abdominal Surgery**  
 Darmklemmen für Kinder  
 Intestinal Clamps for Children

**EA**

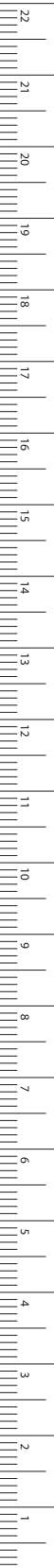

MILLIMETERS

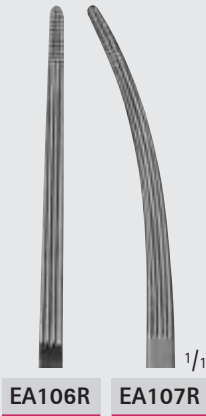

**EA106R**

**EA107R**

**BAINBRIDGE**

**EA106R-EA107R**

155 mm, 6"



1/1

**ALLEN**

**EA114R**

155 mm, 6"

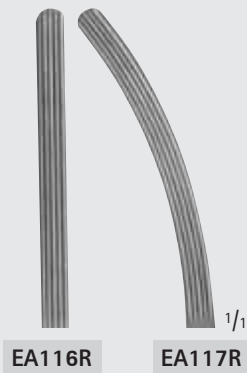

**EA116R**

**EA117R**

**BABY-KOCHER**

**EA116R-EA117R**

sehr elastisch  
 very elastic  
 130 mm, 5 1/8"

**AIRAUMATA®**

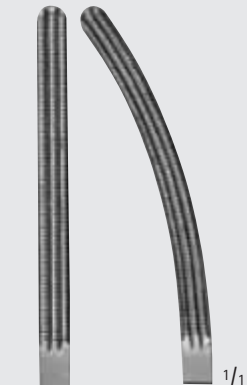

**EA220R**

**EA221R**

**BABY-KOCHER**

**EA220R-EA221R**

weich und elastisch  
 soft and elastic  
 130 mm, 5 1/8"

## Abdominale Chirurgie – Abdominal Surgery

Darmklemmen, weich federnd

Intestinal Clamps, Soft Elastic

EA

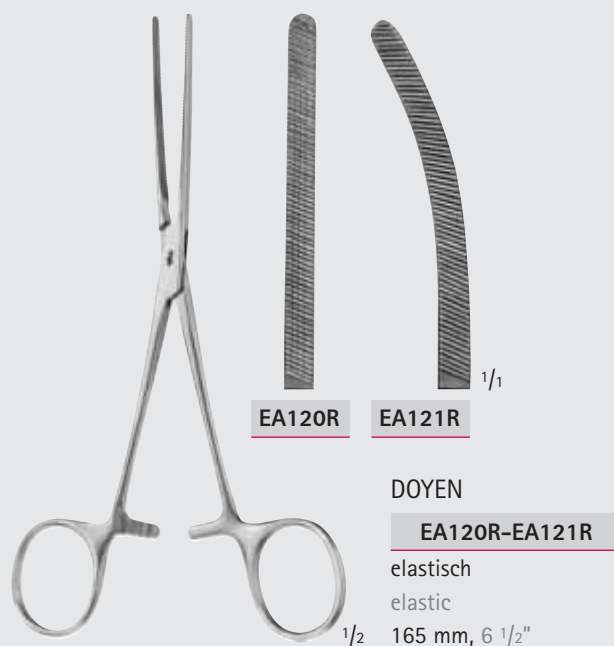
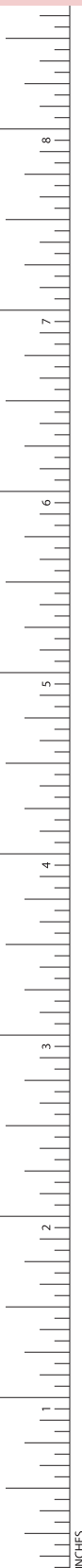

EA120R

EA121R

1/1

DOYEN

EA120R-EA121R

elastisch

elastic

1/2 165 mm, 6 1/2"

ARAUMATA®



EA222R

EA223R

1/1

DOYEN

EA222R-EA223R

weich und elastisch

soft and elastic

1/2 170 mm, 6 3/4"

ARAUMATA®

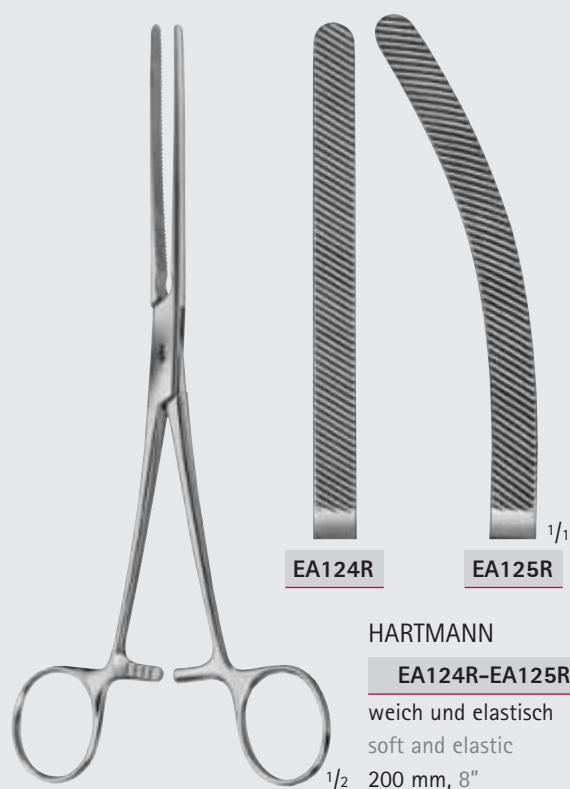

EA124R

EA125R

1/1

HARTMANN

EA124R-EA125R

weich und elastisch

soft and elastic

1/2 200 mm, 8"

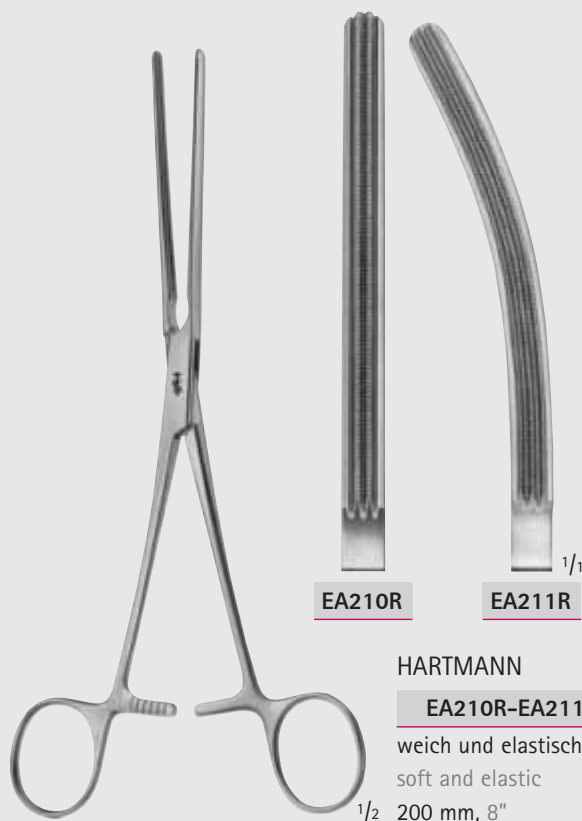

EA210R

EA211R

1/1

HARTMANN

EA210R-EA211R

weich und elastisch

soft and elastic

1/2 200 mm, 8"





## Abdominale Chirurgie – Abdominal Surgery

Darmklemmen, weich federnd  
Intestinal Clamps, Soft Elastic

EA

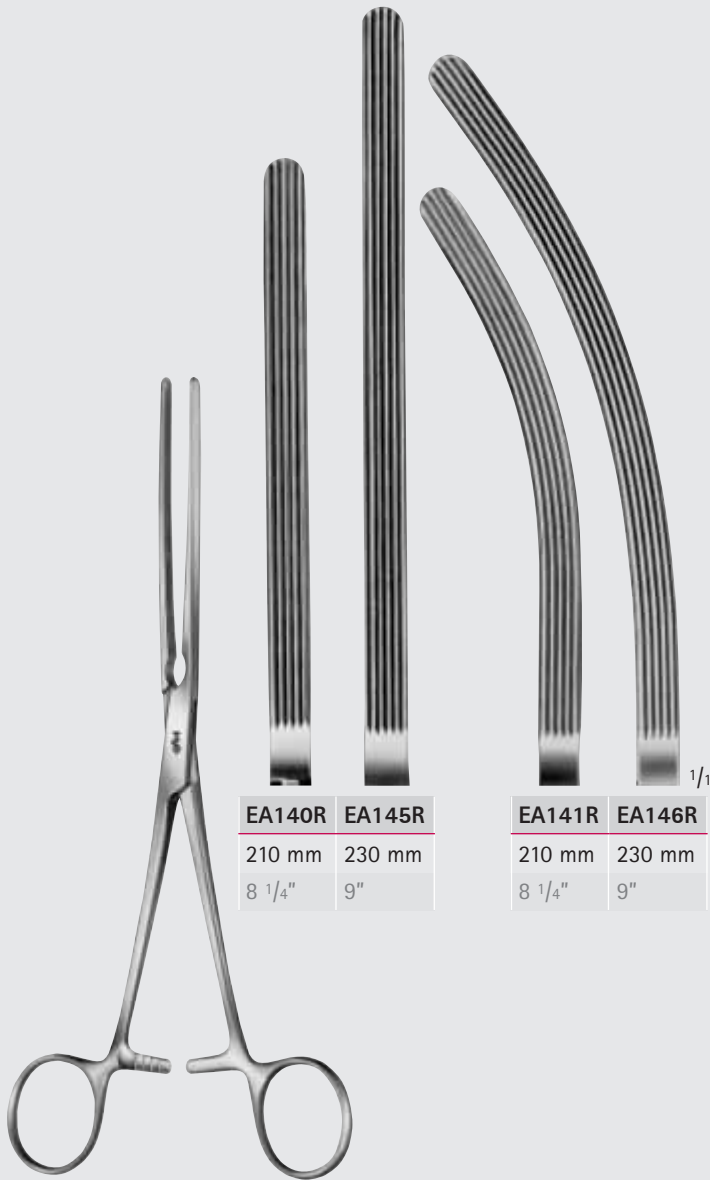

<b>EA140R</b>	<b>EA145R</b>
210 mm	230 mm
8 1/4"	9"

<b>EA141R</b>	<b>EA146R</b>
210 mm	230 mm
8 1/4"	9"

KOCHER

**EA140R-EA146R**

weich und elastisch  
soft and elastic

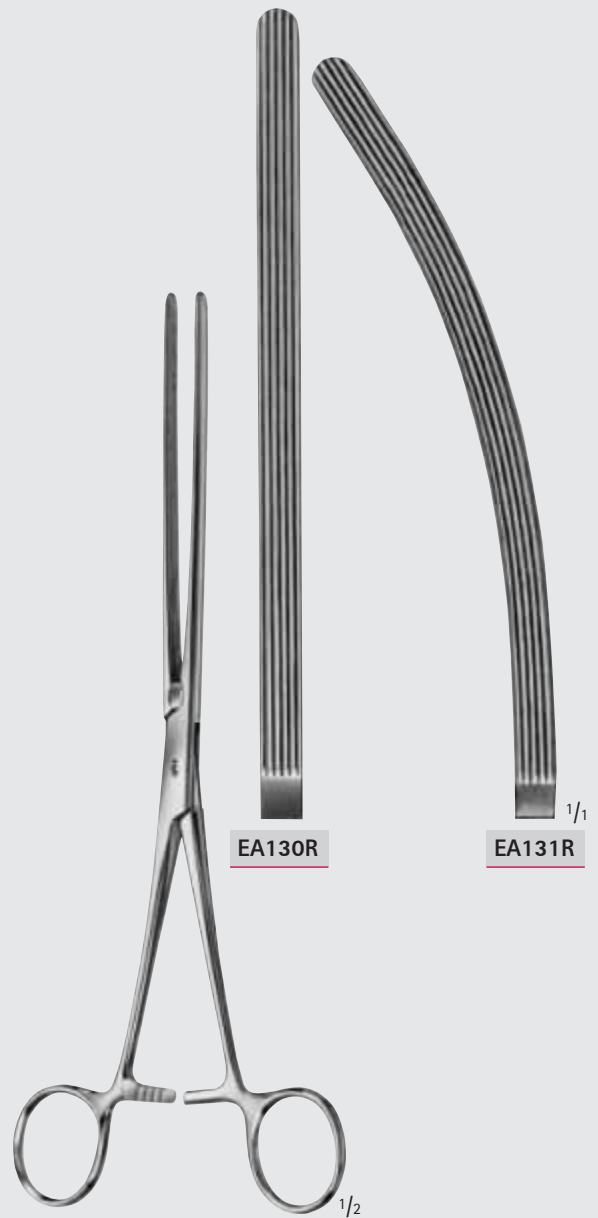

**EA130R**

**EA131R**

DOYEN

**EA130R-EA131R**

weich und elastisch  
soft and elastic  
240 mm, 9 1/2"

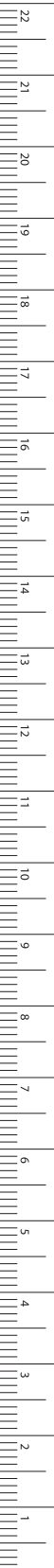

MILLIMETERS

## Abdominale Chirurgie – Abdominal Surgery

Darmklemmen, weich federnd

Intestinal Clamps, Soft Elastic

EA



DOYEN

**EA126R-EA127R**

weich und elastisch

soft and elastic

235 mm, 9 1/4"



DOYEN

**EA212R-EA213R**

weich und elastisch

soft and elastic

230 mm, 9"

AIRAUMATA®



## Abdominale Chirurgie – Abdominal Surgery

Darmklemmen, weich federnd  
Intestinal Clamps, Soft Elastic

EA

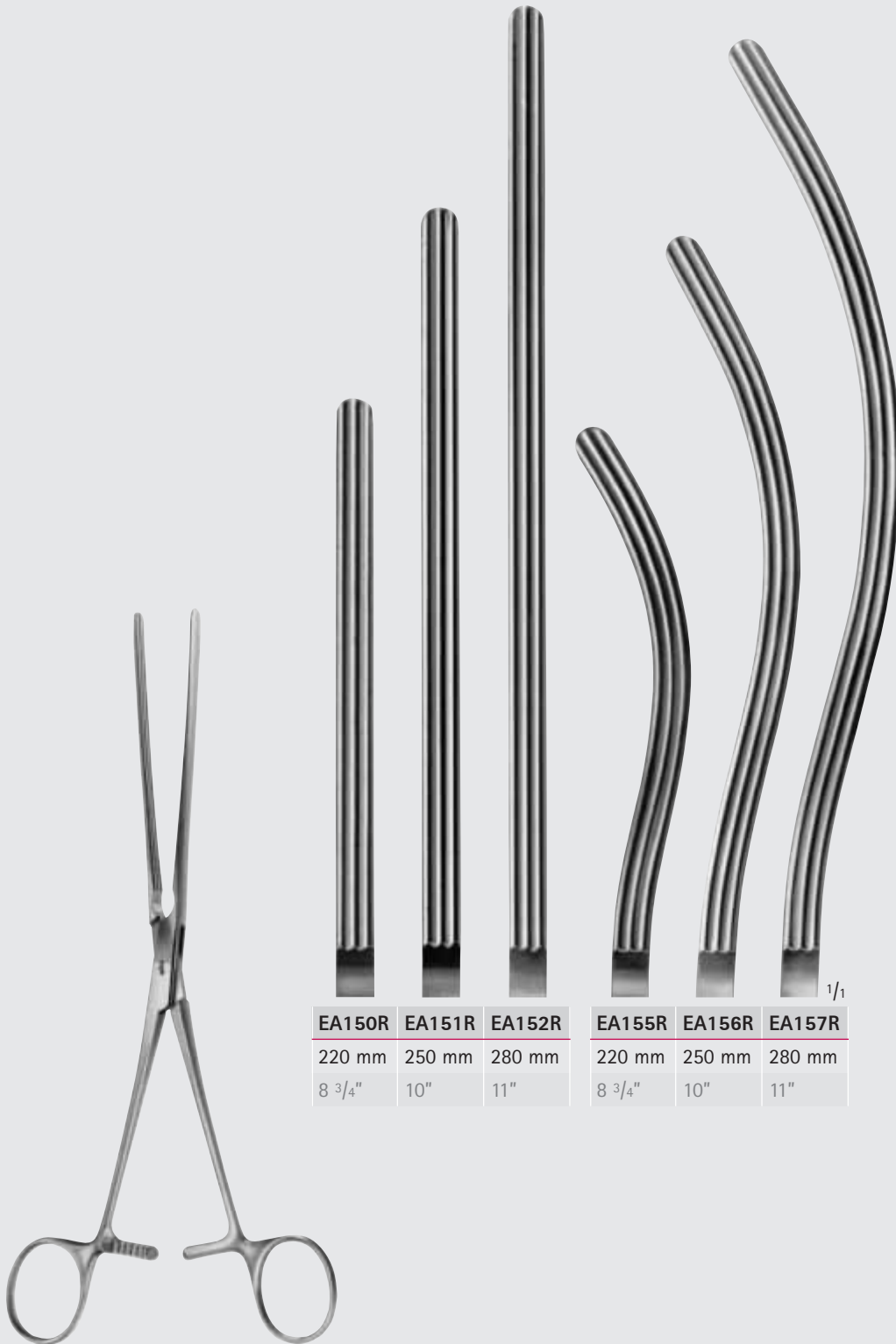

EA150R	EA151R	EA152R	EA155R	EA156R	EA157R
220 mm	250 mm	280 mm	220 mm	250 mm	280 mm
8 3/4"	10"	11"	8 3/4"	10"	11"

1/1

KOCHER

**EA150R-EA157R**

sehr weich und elastisch  
very soft and elastic



MILLIMETERS

## Abdominale Chirurgie – Abdominal Surgery

Darmklemmen, weich federnd

Intestinal Clamps, Soft Elastic

EA

TRAUMATA®



KOCHER

EA202R-EA207R

sehr weich und elastisch

very soft and elastic

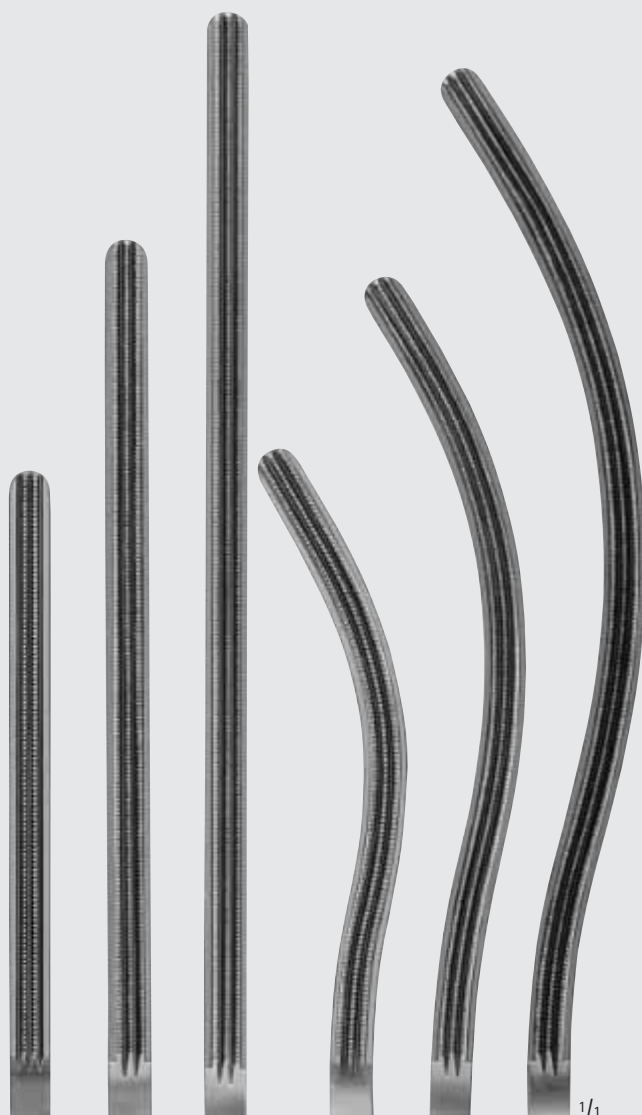

EA202R	EA204R	EA206R	EA203R	EA205R	EA207R
220 mm	250 mm	280 mm	220 mm	250 mm	280 mm
8 3/4"	10"	11"	8 3/4"	10"	11"



## Abdominale Chirurgie – Abdominal Surgery

Darmklemmen  
Intestinal Clamps

EA

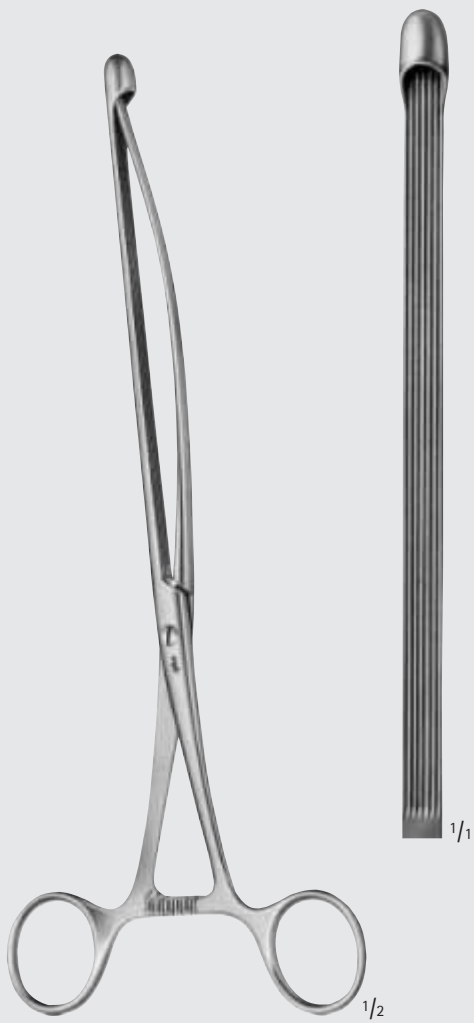

NUSSBAUM

EA176R

weich und elastisch  
soft and elastic  
250 mm, 10"

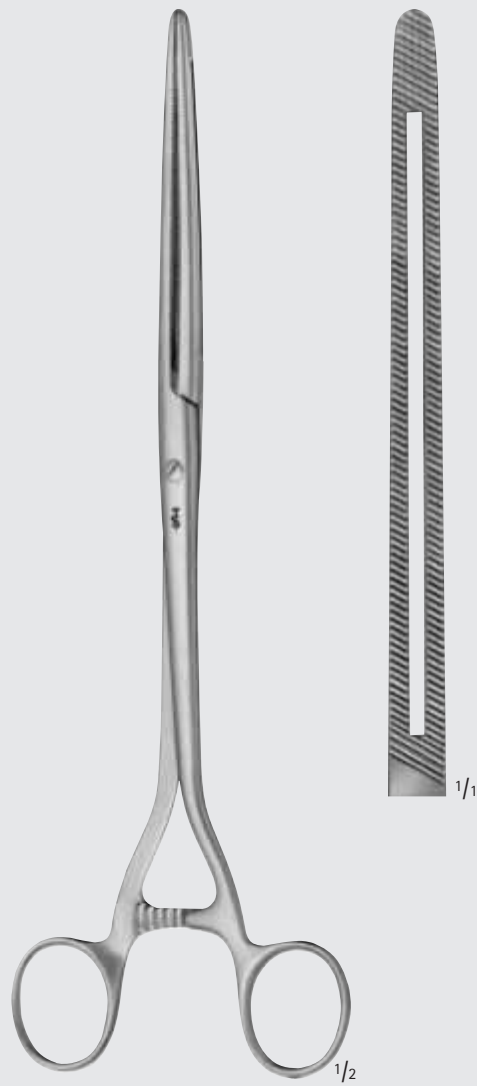

MOYNIHAN

EA182R

280 mm, 11"



MILLIMETERS

## Abdominale Chirurgie – Abdominal Surgery

Darmklemmen

Intestinal Clamps

EA

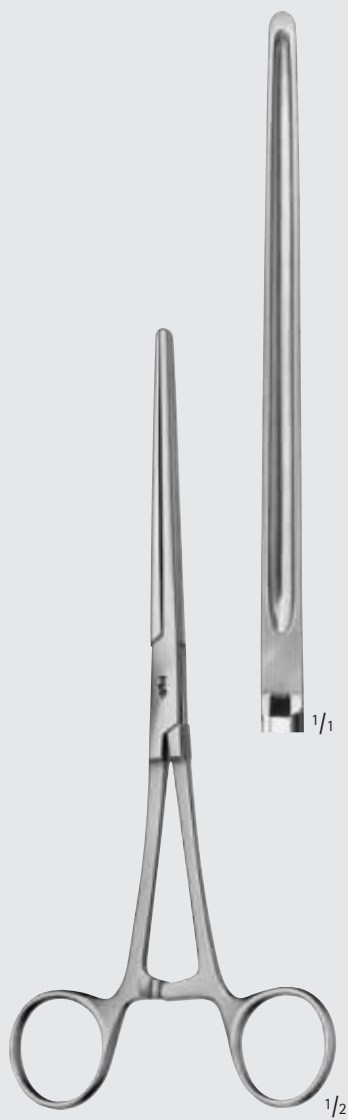

LANG-STEVENSON

EA132R

200 mm, 8"

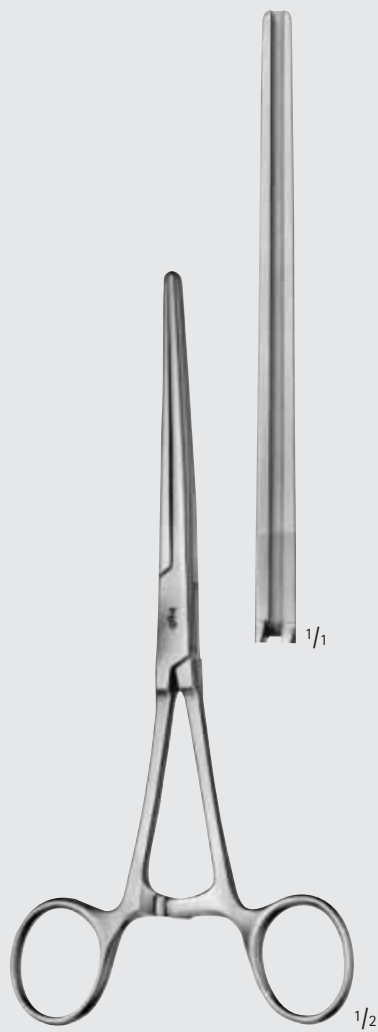

SCHOEMAKER

EA321R

Colectomie-Klemme

Colectomy clamp

200 mm, 8"



## Abdominale Chirurgie – Abdominal Surgery

Darmklemmen  
Intestinal Clamps

EA

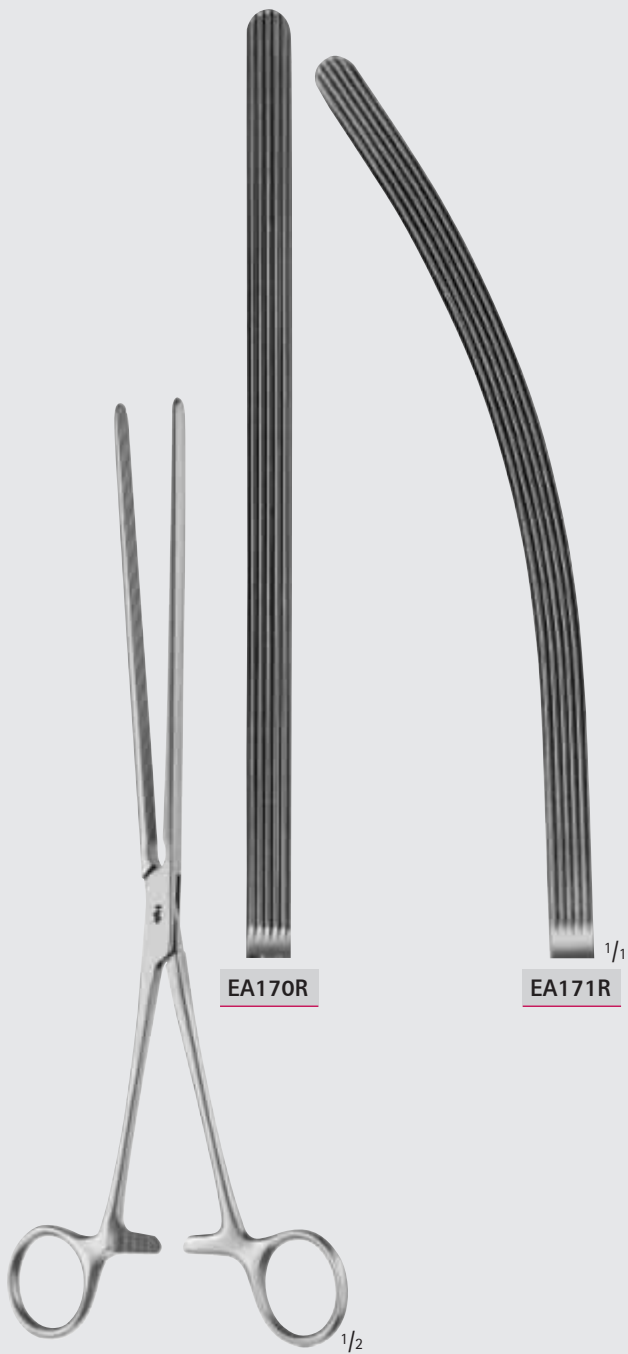

EA170R

EA171R <sup>1/1</sup>

MAYO-ROBSON

EA170R-EA171R

hart federnd  
hard elastic  
250 mm, 10"

AIRAUMATA<sup>®</sup>

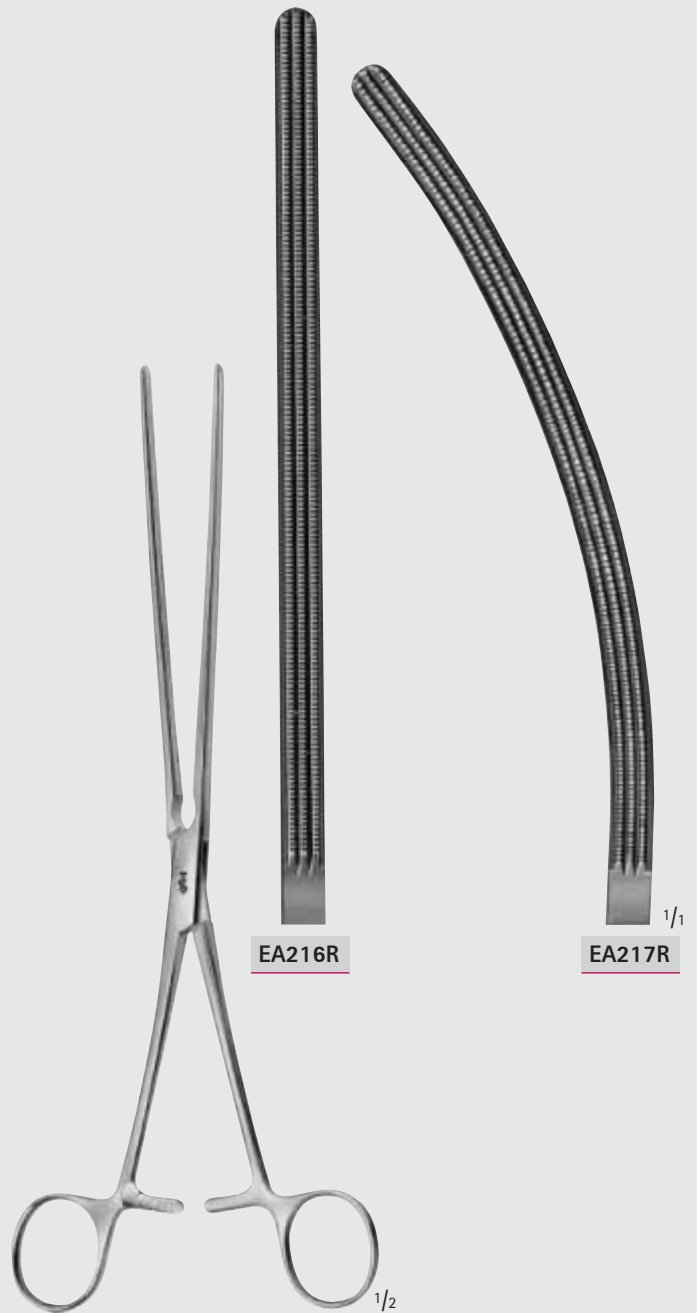

EA216R

EA217R <sup>1/1</sup>

MAYO-ROBSON

EA216R-EA217R

250 mm, 10"

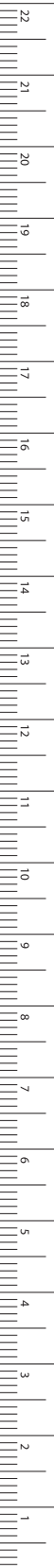

MILLIMETERS

## Abdominale Chirurgie – Abdominal Surgery

Magen- und Darm- Zwillingsklemmen

Gastro- Intestinal Forceps, Twin

EA

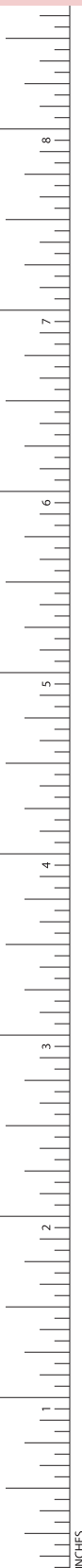

LANE

EA440R

310 mm, 12"



LANE

EA441R

310 mm, 12"





# Abdominale Chirurgie – Abdominal Surgery

Magenklemmen  
Stomach Clamps

EA

AIRAUMATA®

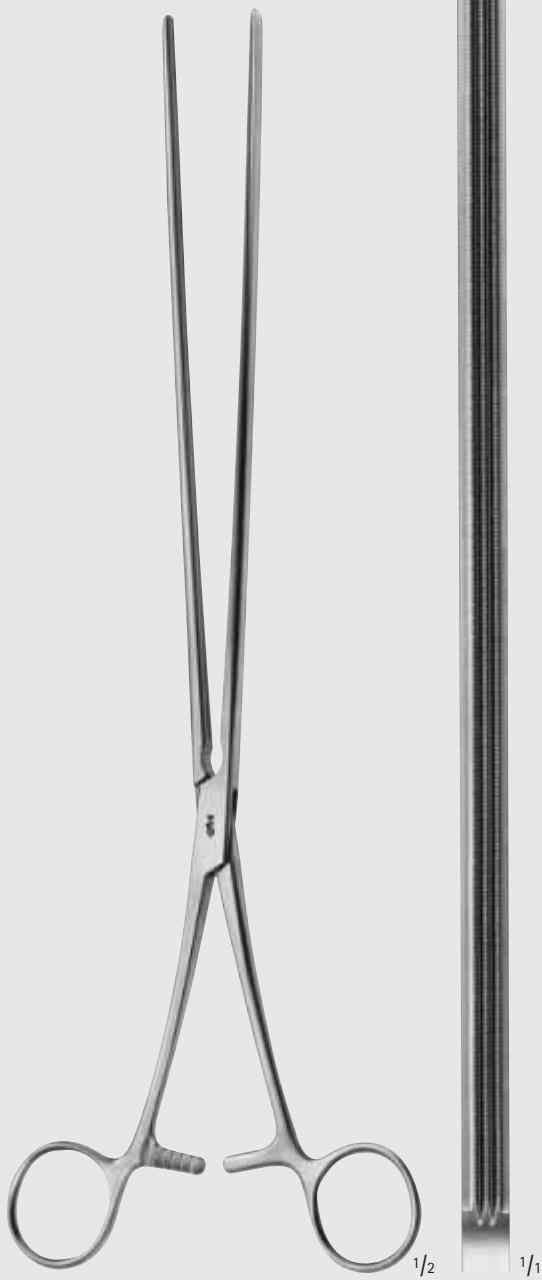

SCUDDER

**EA240R**

330 mm, 13"



KLEINSCHMIDT

**EA397R**

Spornquetschen und  
Appendektomieklammern

Spur crushers and  
Appendectomy clamps

130 mm, 5 1/8"



BENSON

**EA466R**

Pylorusspreizer

Pylorus spreader

155 mm, 6"



MILLIMETERS

## Abdominale Chirurgie – Abdominal Surgery

Darm- und Magenquetschklemmen

Intestinal and Pylorus Clamps

EA



PAYR

**EA305R**

Darmquetschklemme,  
leichtes Modell,  
für Kinder

Intestinal clamp  
light pattern,  
for children

180 mm, 7"

PAYR

**EA306R**

200 mm, 8"

PAYR

**EA309R**

275 mm, 10 3/4"

PAYR

**EA450R**

Magenquetschklemme  
Pylorus clamp

315 mm, 12 1/2"



## Abdominale Chirurgie – Abdominal Surgery

### Anastomosenklemmen Anastomosis Clamps

EA



DE MARTEL-WOLFSON

**EA331R-EA332R**

Anastomosenklemmen,  
Satz zu 3 Stück

Anastomosis clamps,  
set of 3 pieces

EA331R	EA332R
100 mm	120 mm
4"	4 3/4"



Klemmenhalter mit Klemmsatz  
Clamp holder with set of clamps

**EA334R-EA336R**

Klemmenhalter  
für EA331R, EA332R

Clamp holder  
for EA331R, EA332R

EA334R	EA336R
80 mm	225 mm
3 1/8"	9"



DE MARTEL-WOLFSON

**EA338R**

Schließzange  
für EA331R, EA332R

Closing forceps  
for EA331R, EA332R  
250 mm, 10"

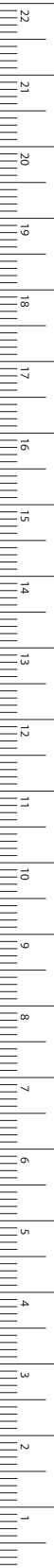

MILLIMETERS

## Abdominale Chirurgie – Abdominal Surgery

Anastomosenklemmen

Anastomosis Forceps

EA

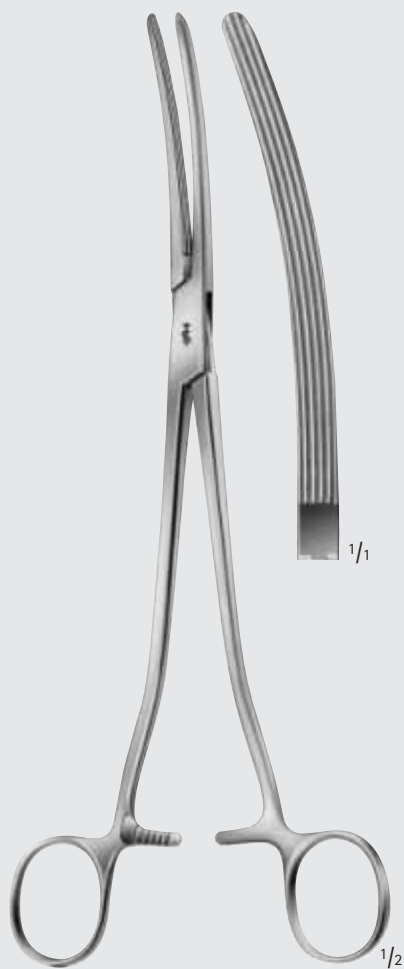

PARKER-KERR

**EA365R**

Anastomosenklemme für Colonresektion  
Anastomosis forceps for colon resection  
250 mm, 10"

ARAUMATA®

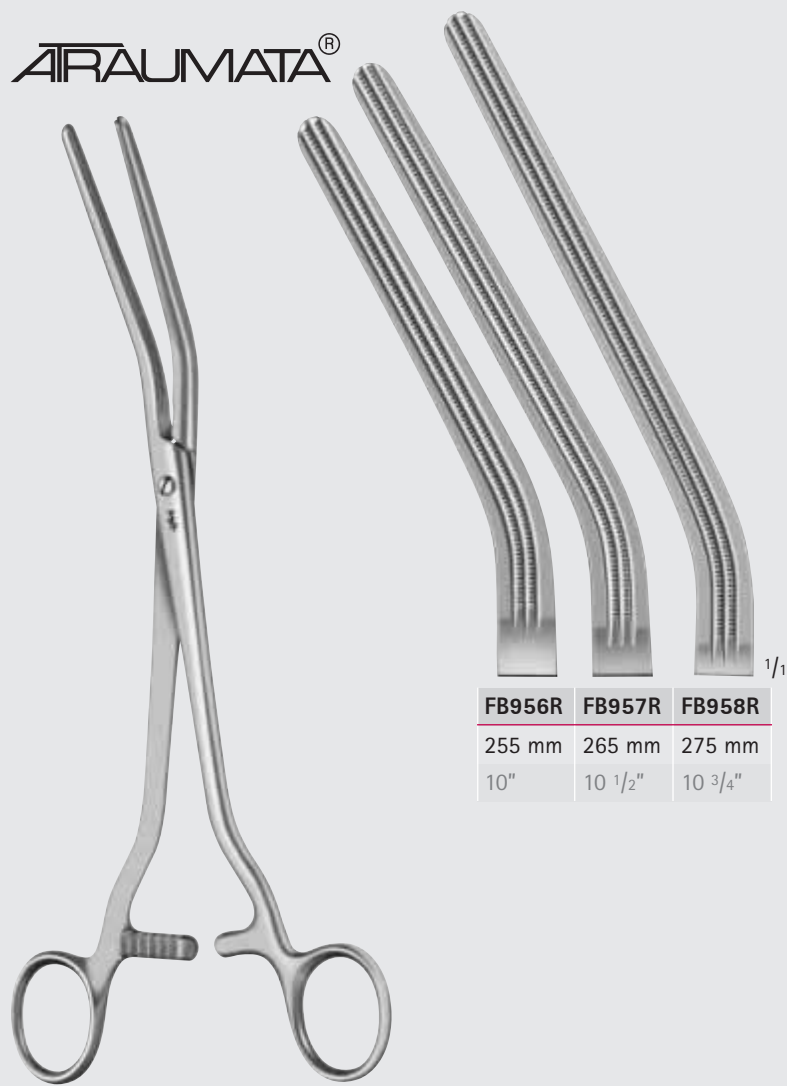

FB956R	FB957R	FB958R
255 mm	265 mm	275 mm
10"	10 1/2"	10 3/4"

DICK

**FB956R-FB958R**

Druckklemmen  
Pressure clamps



## Abdominale Chirurgie – Abdominal Surgery

Rektum-Anastomosenklemmen  
Sigmoid Anastomosis Forceps

EA



BRUNNER

EA191R

245 mm, 9 3/4"



FB954R

60 mm

FB955R

80 mm

FB954R-FB955R

230 mm, 9"



MILLIMETERS

## Abdominale Chirurgie – Abdominal Surgery

Rektum-Anastomosenklemmen

Sigmoid Anastomosis Forceps

EA

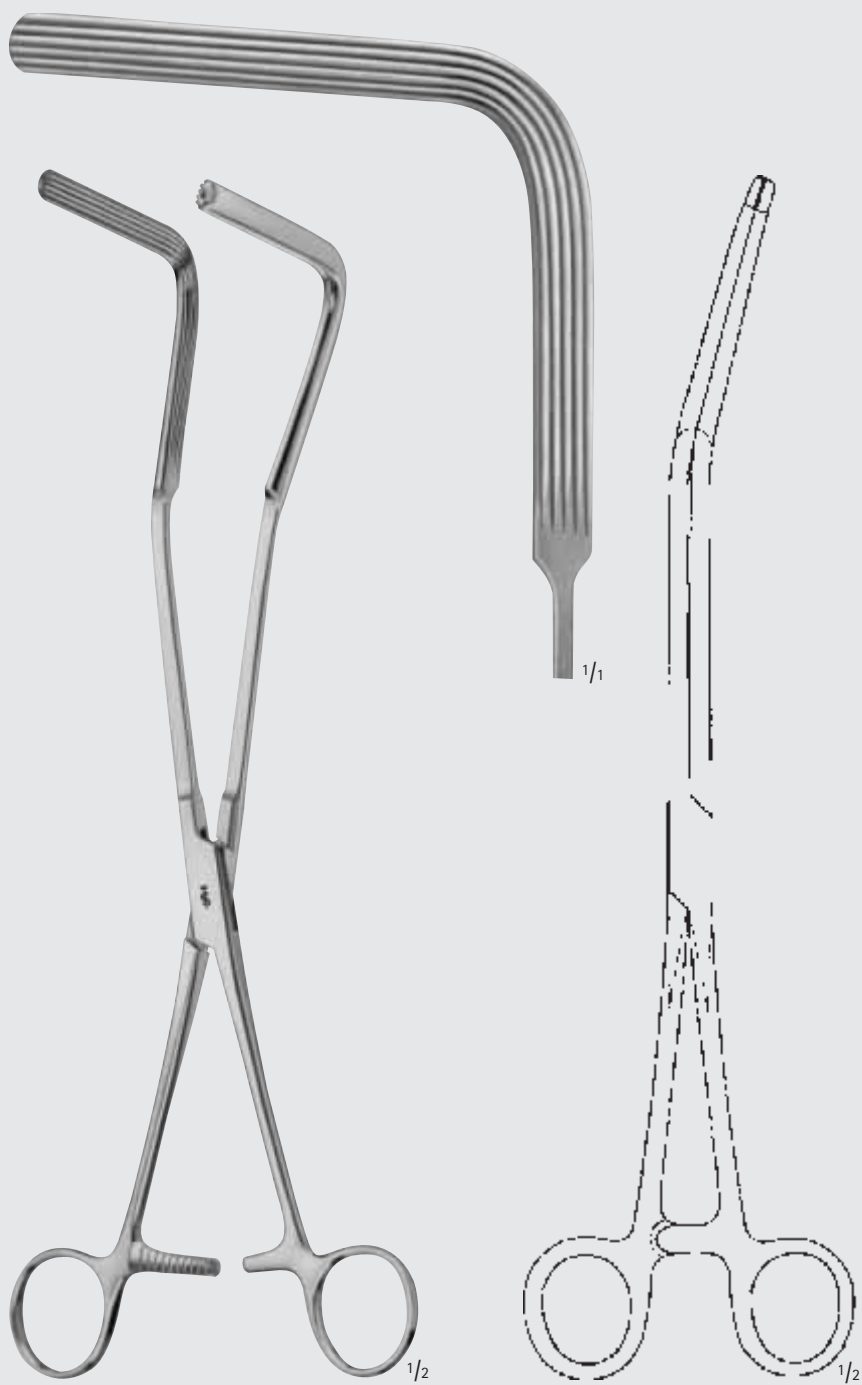

LLOYD-DAVIS

EA362R

315 mm, 12 1/2"



AIRAUMATA®

Abdominale Chirurgie – Abdominal Surgery  
Rektum-Anastomosenklemmen  
Sigmoid Anastomosis Forceps

EA

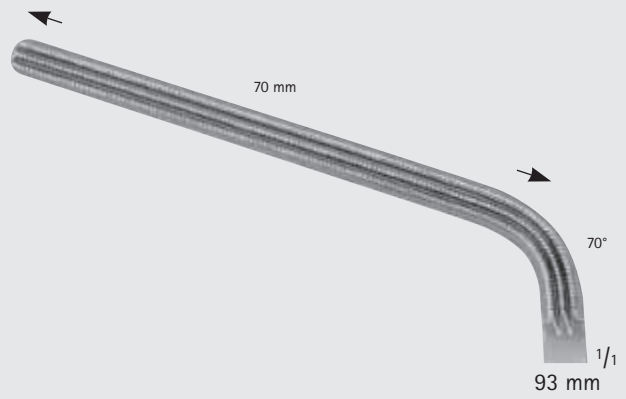
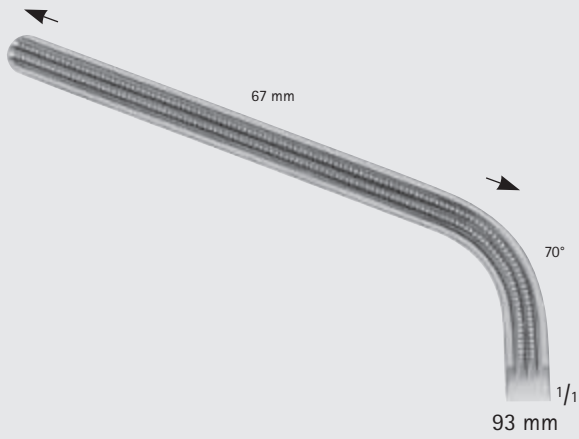

MORRIS

FB493R

175 mm, 7"

DE BAKEY  
(MORRIS MODIF.)

FB494R

240 mm, 9"



MILLIMETERS

## Abdominale Chirurgie – Abdominal Surgery

Rektum-Anastomosenklemmen

Sigmoid Anastomosis Forceps

TRAUMATA®

EA

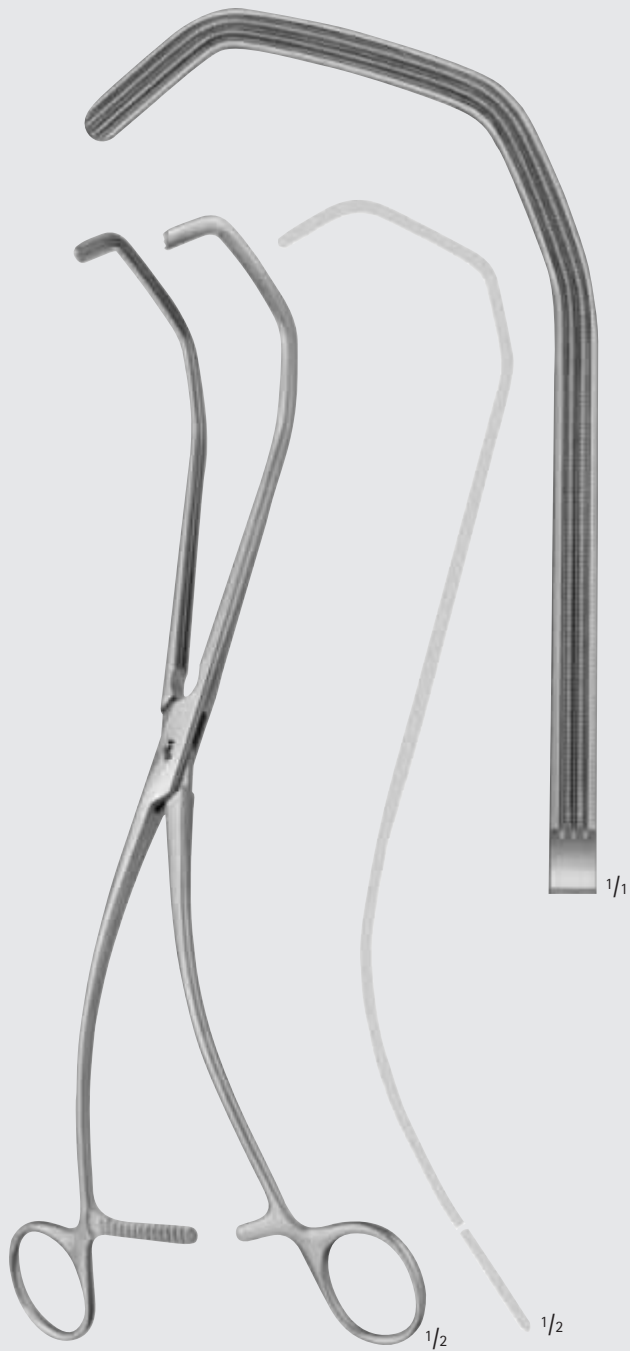

KERSTING

EA355R

300 mm, 12"



RESANO

EA360R

elastisch

elastic

265 mm, 10 1/2"





## Abdominale Chirurgie – Abdominal Surgery

Rektum-Scheren

Rectal Scissors

EA



LLOYD-DAVIES  
(GOLIGHER'S)

BC621R

270 mm, 10 <sup>3</sup>/<sub>4</sub>"

STELZNER

BC622R-BC623R

310 mm, 12 <sup>3</sup>/<sub>8</sub>"

BC617R

325 mm, 13"

MILLIMETERS

## Abdominale Chirurgie – Abdominal Surgery

Instrumente zur tiefen Rektumchirurgie

Instruments for Deep Rectum Surgery

EA

AIRAUMATA®

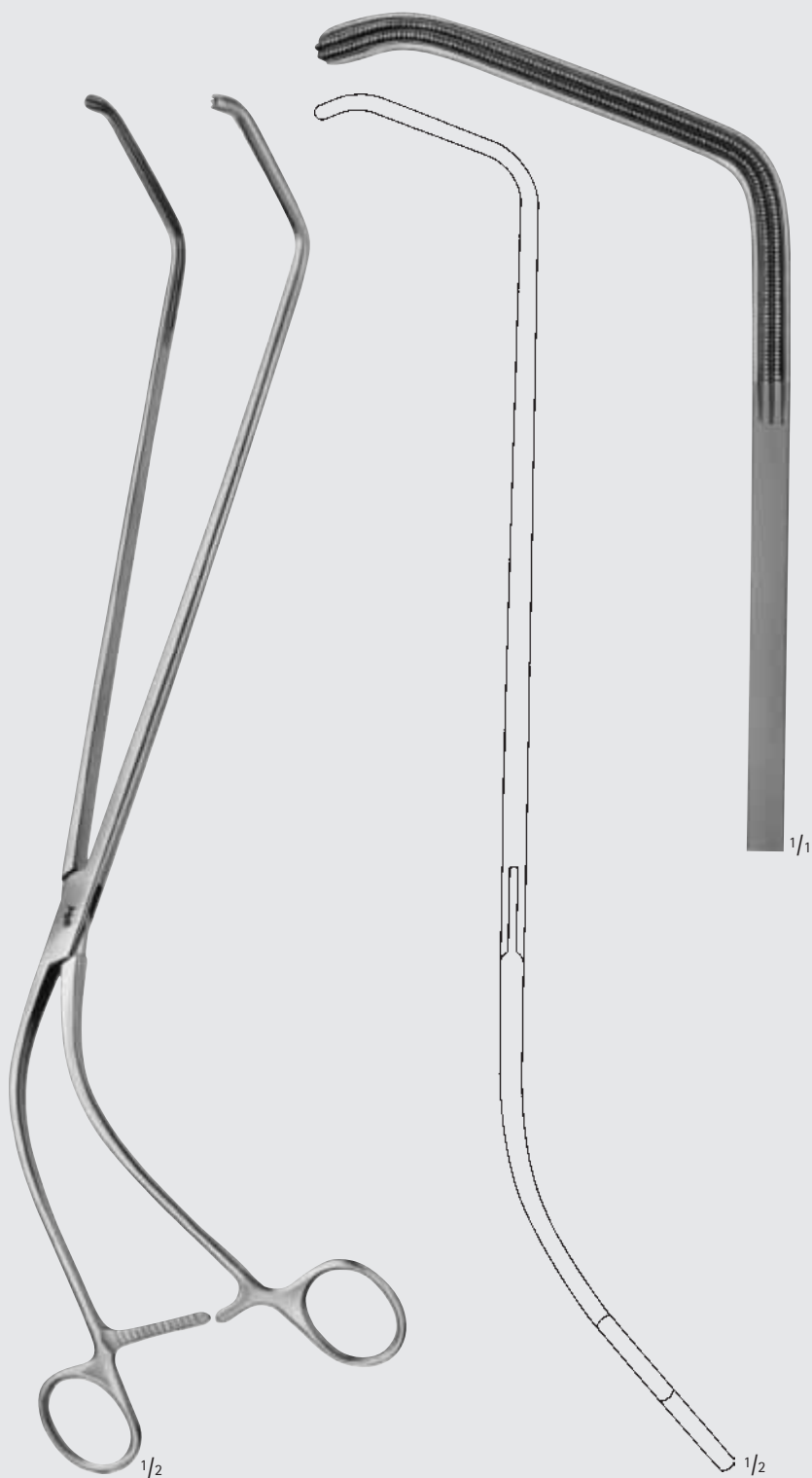

MÜLLER

EA356R

Rektum-Anastomosenklemme

Rectal anastomosis clamp

375 mm, 15"



## Abdominale Chirurgie – Abdominal Surgery

Instrumente zur tiefen Rektumchirurgie  
Instruments for Deep Rectum Surgery

EA

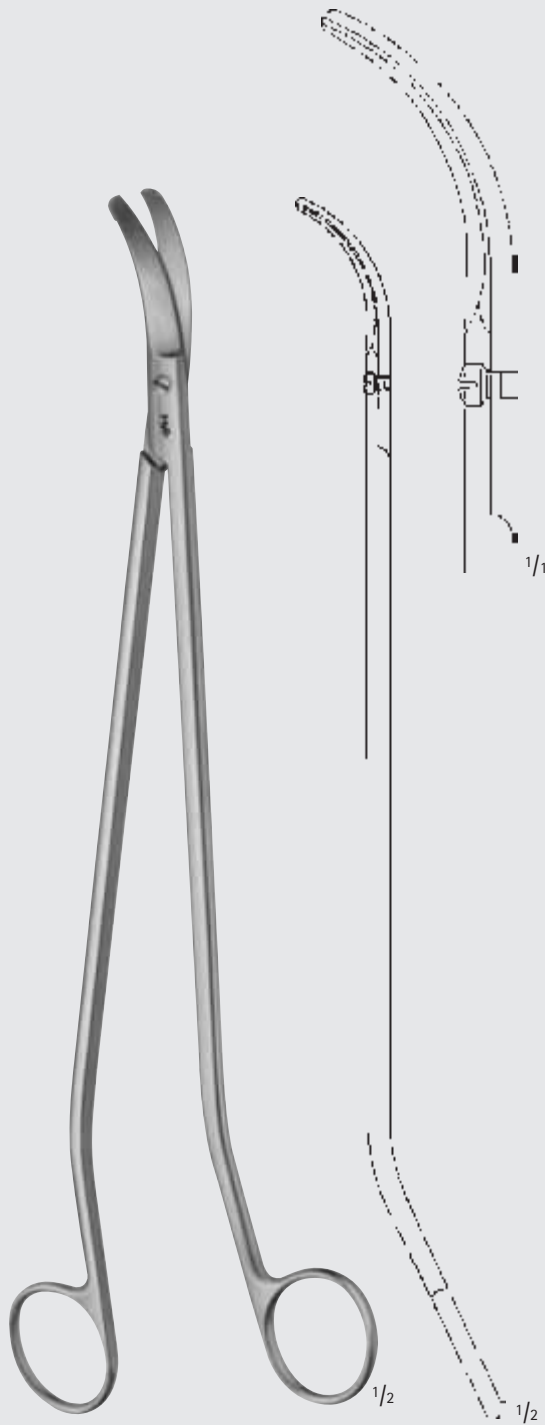

MÜLLER

**BC627R**

Rektumschere, s-förmig  
Rectum scissors, s-shaped  
325 mm, 13"

AIRAUMATA®



DE BAKEY

**FB409R**

350 mm, 14"

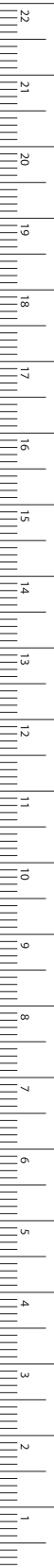

MILLIMETERS

## Abdominale Chirurgie – Abdominal Surgery

Instrumente zur tiefen Rektumchirurgie

Instruments for Deep Rectum Surgery

EA



MÜLLER

**BM089R**

Nadelhalter

Needle holder

360 mm, 14"

AIRAUMATA®



ALLIS

**EA100R**

Fasszange

Grasping forceps

295 mm, 11 3/4"



# Abdominale Chirurgie – Abdominal Surgery

Instrumente zur tiefen Rektumchirurgie  
Instruments for Deep Rectum Surgery

EA



HÖSEL

**BT446R**

Wundhaken

Retractor

250 mm, 10"

MILLIMETERS

# Abdominale Chirurgie – Abdominal Surgery

## Mastdarm-Rektum-Spekula

### Rectal Specula

EA

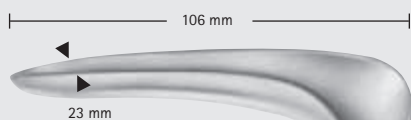

**CZERNY**  
**EA800R**

225 mm, 9"

1/2

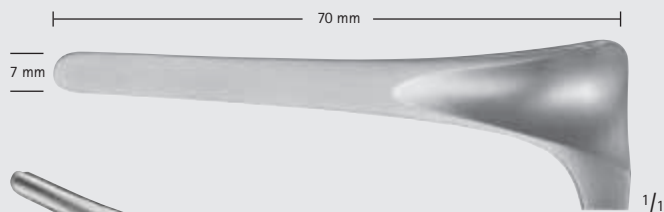

**KILLIAN**

**OK093R**

für Kinder  
for children  
145 mm, 5 1/2"

1/2



**SIMS**  
**EA820R**

160 mm, 6 1/4"

1/2



**SIMS**  
**EA821R**

160 mm, 6 1/4"

1/2



## Abdominale Chirurgie – Abdominal Surgery

### Mastdarm-Rektum-Spekula Rectal Specula



**EA825R-EA829R**

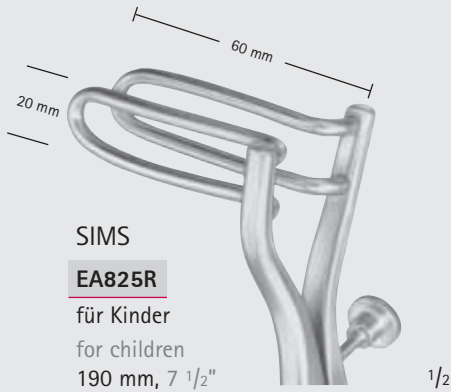

SIMS

**EA825R**

für Kinder  
for children

190 mm, 7 1/2"

1/2

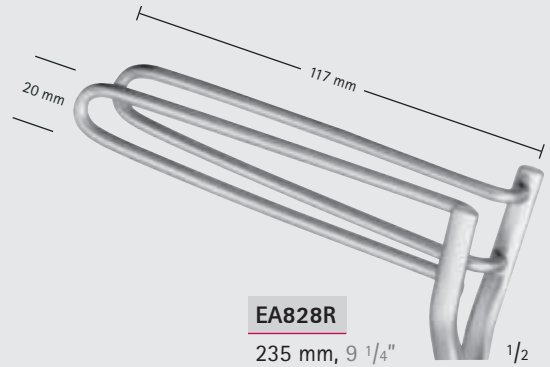

**EA828R**

235 mm, 9 1/4"

1/2

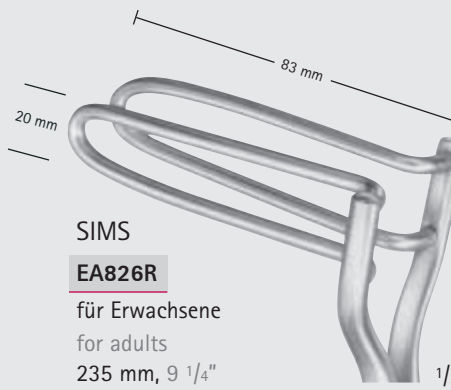

SIMS

**EA826R**

für Erwachsene  
for adults

235 mm, 9 1/4"

1/2

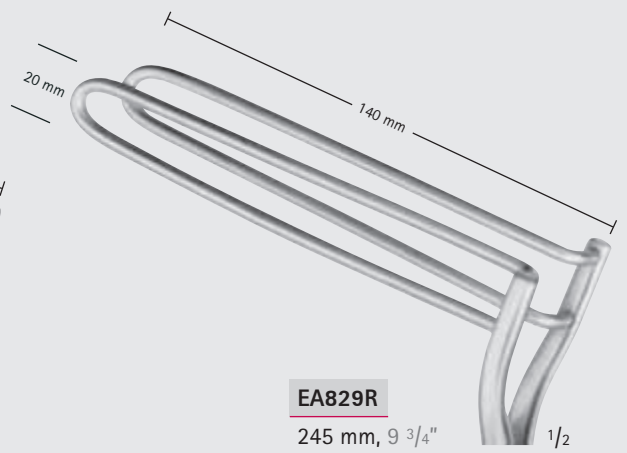

**EA829R**

245 mm, 9 3/4"

1/2



PRATT

**EA831R**

205 mm, 8"

1/2

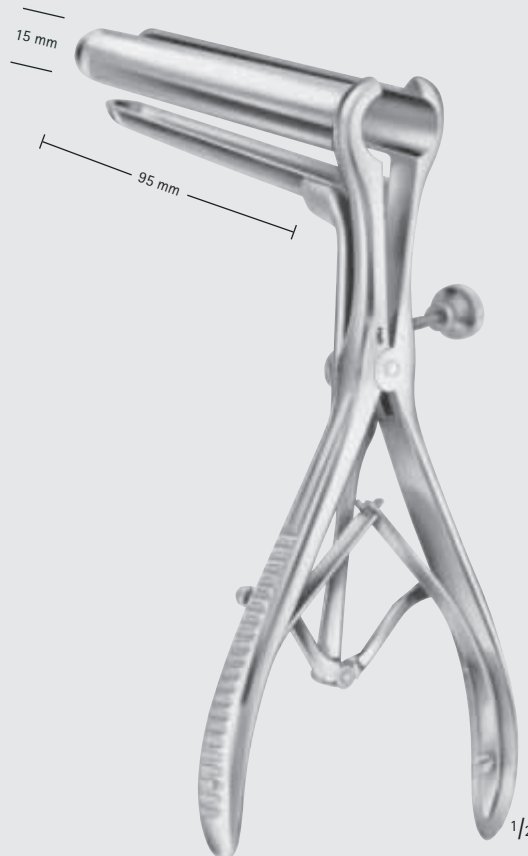

MATHIEU

**EA843R**

215 mm, 8 1/2"

1/2

EA

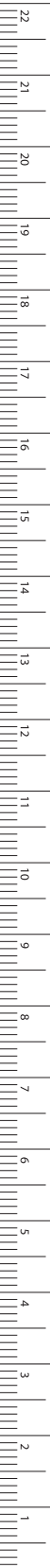

MILLIMETERS

## Abdominale Chirurgie – Abdominal Surgery

Anuskope - Sphinkteroskope

Anusscopes - Sphincteroscopes

EA

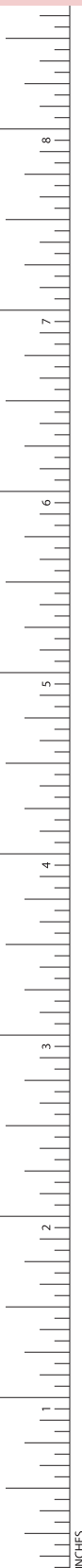

BENSAUDE

**EA862C-EA864C**

Anuskope

Anusscopes

185 mm, 7 1/4"

Ø  
diam.

**EA862C** 17 mm

**EA863C** 20 mm

**EA864C** 23 mm

1/2



IVES-FANSLER

**EA880R**

Anuskop, Ø 24 mm

Anuscope, diam. 24 mm

145 mm, 5 3/4"

1/2



KELLY

**EA882R**

Sphinkteroskop, Ø 20 mm

Anuscope, diam. 24 mm

160 mm, 6 1/4"

1/2



KELLY

**EA883R**

Sphinkteroskop, Ø 25 mm

Sphincteroscope, diam. 25 mm

160 mm, 6 1/4"

1/2





## Abdominale Chirurgie – Abdominal Surgery

Protoskop – Analspreizer  
Proctoscope – Rectal Retractor

EA

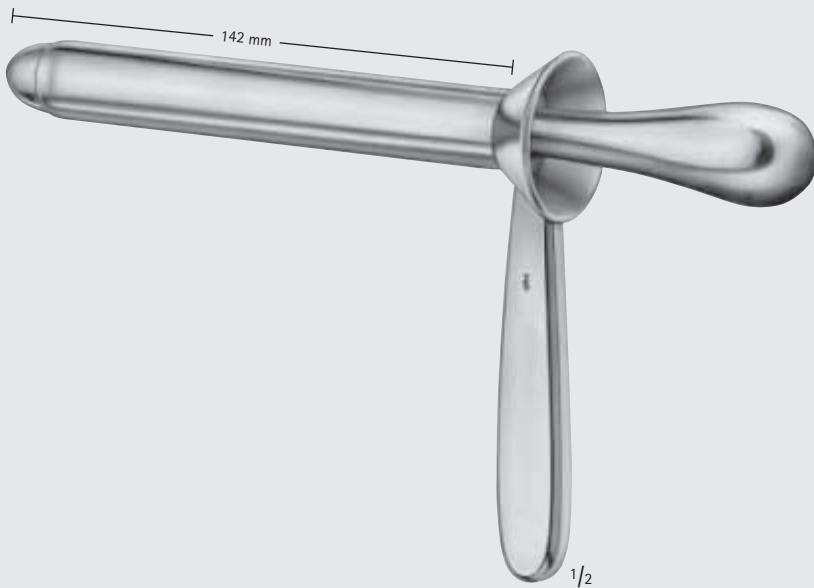

KELLY

**EA887R**

Proktoskop, Ø 20 mm

Proctoscope, diam. 20 mm

140 mm, 5 1/2"

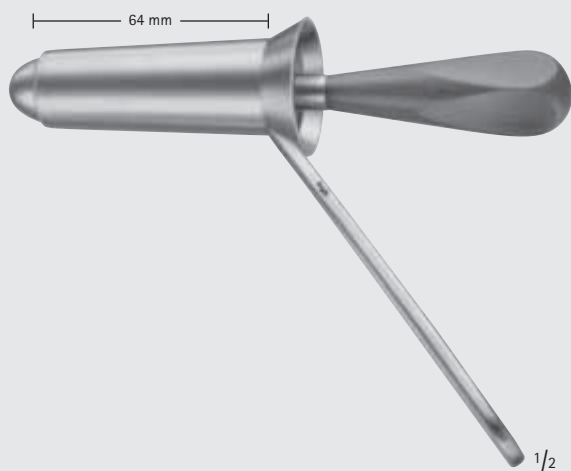

GABRIEL

**EA853R**

Rektum-Spekulum, Ø 25 mm

Rectal speculum, diam. 25 mm

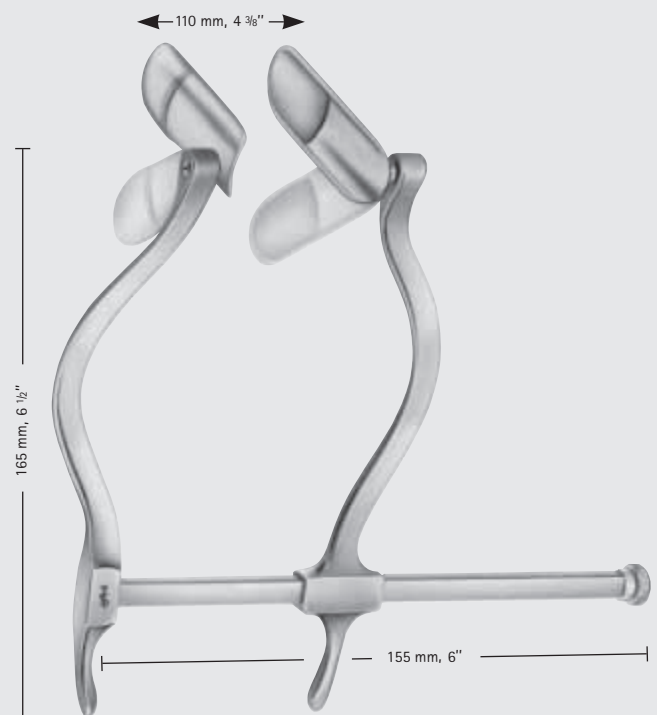

SMITH-BUIE

**BV906R**

Analspreizer

Blattgröße: 58 x 23 mm

Rectal retractor

Dimension of blades: 58 x 23 mm

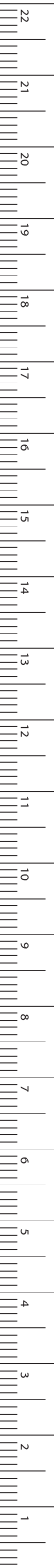

MILLIMETERS

## Abdominale Chirurgie – Abdominal Surgery

Rektum-Spekula

Rectal Specula

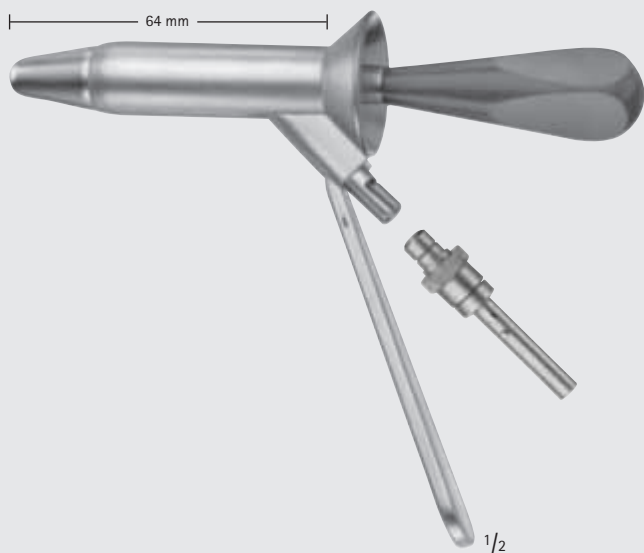

NAUNTON-MORGAN

**EA871R-EA875R**

Rektum-Spekula  
mit Anschluss für Kaltlichtaufsatz EA876R

Rectal specula  
with connector for fibre light attachment  
EA876R

165 mm, 6 1/2"

Ø  
diam.

<b>EA871R</b>	17 mm
<b>EA873R</b>	21 mm
<b>EA875R</b>	24 mm

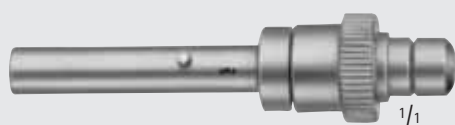

**EA876R**

Kaltlichtaufsatz, ACM/British Standard  
zu NAUNTON-MORGAN Spekula

Fibre light attachment,  
ACM/British Standard  
for NAUNTON-MORGAN specula



## Abdominale Chirurgie – Abdominal Surgery

Sigmoidoskope und Proktoskope  
Sigmoidoscope and Proctoscope

EA



LLOYD-DAVIES

**EA888R**

Ø 16 mm  
250 mm, 9 <sup>3</sup>/<sub>4</sub>"



LLOYD-DAVIES

**EA889R**

Ø 20 mm  
300 mm, 11 <sup>3</sup>/<sub>4</sub>"

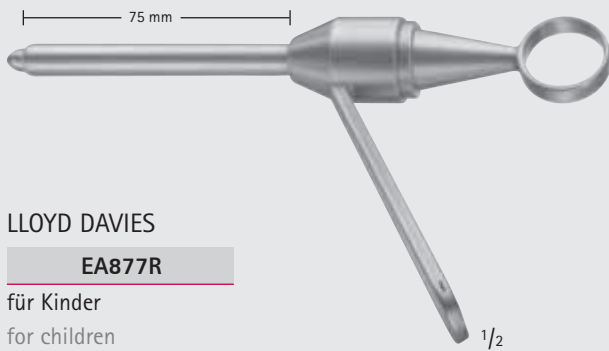

LLOYD DAVIES

**EA877R**

für Kinder  
for children

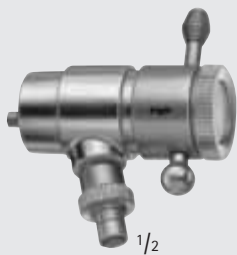

**EA878R**

Kaltlichtaufsatz, ACM/British Standard  
zu EA887R, EA888R und EA889R  
Fibre light attachment, ACM/British Standard  
for EA887R, EA888R and EA889R



**EA879R**

Kaltlichtstab  
Fibre light carrier

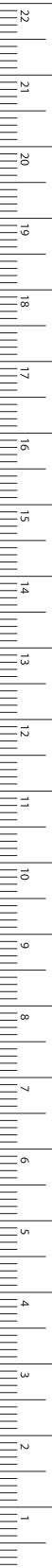

MILLIMETERS

# Abdominale Chirurgie – Abdominal Surgery

## Anal spreizer Rectal Spreader

 KUGELSCHNELLVERSCHLUSS  
BALL SNAP CLOSURE

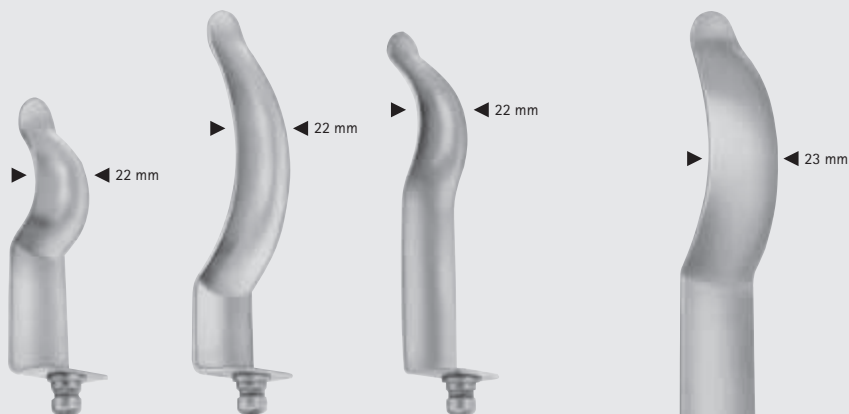

**BV583R**  
Rektumblätter  
70 mm tief  
**PAA = Paar**  
Rectal blades  
70 mm deep  
**PAA = pair**

**BV584R**  
Sphinkterblätter  
93 mm tief  
**PAA = Paar**  
Sphincter blades  
93 mm deep  
**PAA = pair**

**BV586R**  
Blätter für Anastomosen  
90 mm tief  
**PAA = Paar**  
nicht in BV585R enthalten  
Blades for anastomosis  
90 mm deep  
**PAA = pair**  
not included in BV585R



**PARKS**  
**BV589R**  
150 mm tief  
**PAA = Paar**  
nicht in BV585R enthalten  
150 mm deep  
**PAA = pair**  
not included in BV585R

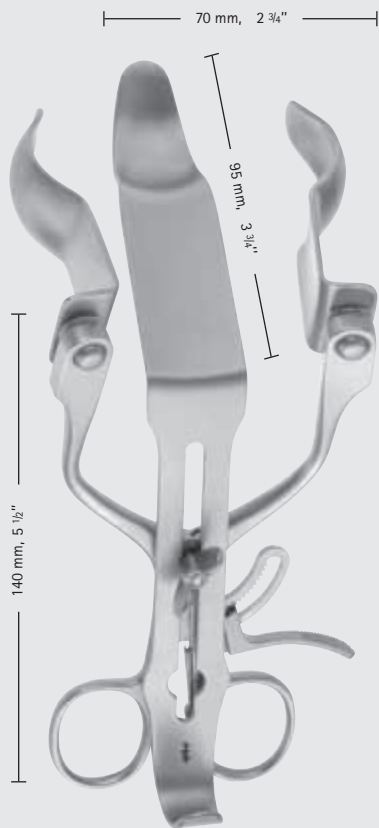

PARKS, MODIF. GIRONA

**BV585R**

Anal spreizer, komplett bestehend aus:  
BV581R Sperrer, allein  
BV582R Mittelblatt, allein  
BV583R Paar Blätter, allein  
BV584R Paar Blätter, allein  
Rectal spreader, complete consisting of:  
BV581R Spreader, only  
BV582R Center blade, only  
BV583R Pair of blades, only  
BV584R Pair of blades, only



**BV591R**  
Mittelblatt für Kaltlicht mit Aufnahme für Kaltlichtstab OP801  
nicht in BV585R enthalten  
Center blade with connection for cold light carrier OP801  
not included in BV585R



**OP801**  
Kaltlichtstab zur zusätzlichen, intensiven Ausleuchtung des OP-Feldes  
Cold light carrier for additional, intensive illumination of the operating area

EA





## Abdominale Chirurgie – Abdominal Surgery

### Perineal Sperrer Perineal Retractor



KUGELSCHNELLVERSCHLUSS  
BALL SNAP CLOSURE

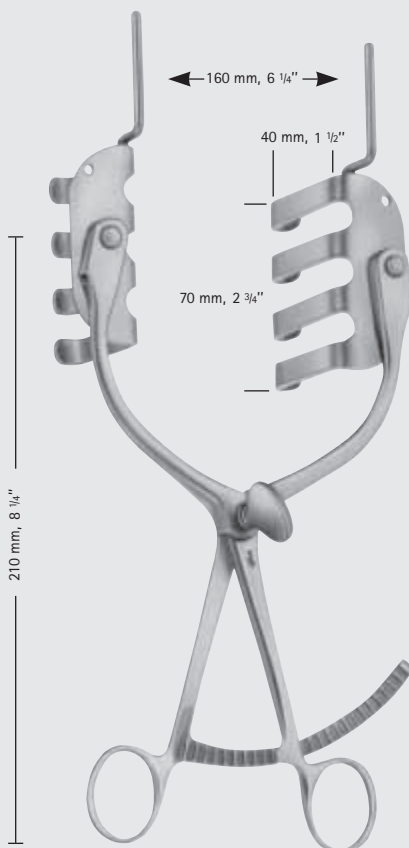

ST. MARKS, MODIF. GIRONA

**BV907R**

Perineal Sperrer mit  
Tuchhaltestift an den Blättern  
Perineal retractor with towel pegs  
fitted to swivel rake blades

EA

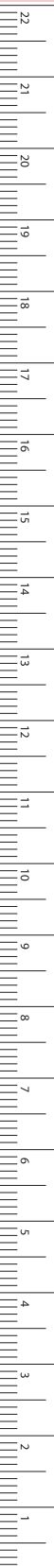

MILLIMETERS

# Abdominale Chirurgie – Abdominal Surgery

Pelvishaken

Pelvis Retractors

EA



ST. MARKS

**BT670R**

290 mm, 11 1/2"

ST. MARKS

**BT672R**

330 mm, 13 1/8"

ST. MARKS

**BT674R**

330 mm, 13 1/8"



## Abdominale Chirurgie – Abdominal Surgery

Analsonden  
Rectal Probes

EA



### LOCKHART-MUMMERY

**BN021R-BN024R**

Fistelsonden  
Fistula probes  
165 mm, 6 1/2"

<b>BN021R</b>	Nr. 1	gerade	No. 1	straight
<b>BN022R</b>	Nr. 2	45° gebogen	No. 2	45° curved
<b>BN023R</b>	Nr. 3	90° gebogen	No. 3	90° curved
<b>BN024R</b>	Nr. 4	retrograd gebogen	No. 4	retrograde curved

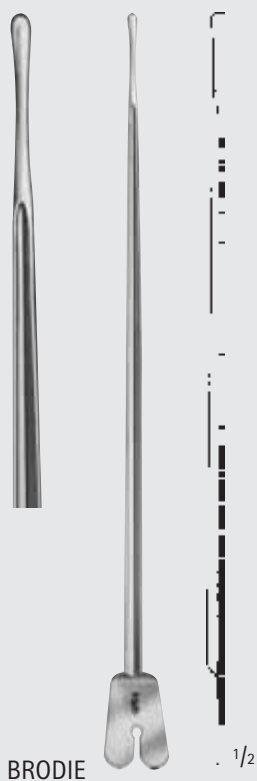

BRODIE

**BN020R**

Hohlsonde mit Knopf,  
Knopf-Ø: 3,5 mm  
Director with tip,  
diam. of tip: 3.5 mm  
200 mm, 8"

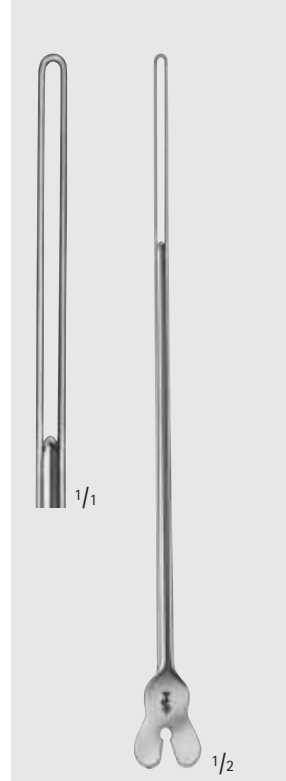

**BN026R**

Ösenrinnensonde,  
biegsam  
Director with wire loop,  
malleable  
190 mm, 7 1/2"

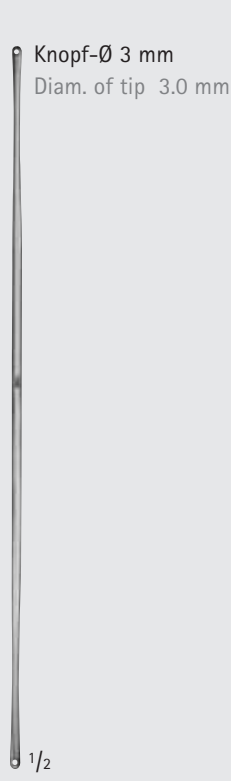

**BN090R**

Doppelknopfsonde,  
biegsam, mit Loch  
Double ended probe,  
malleable, with hole  
190 mm, 7 1/2"

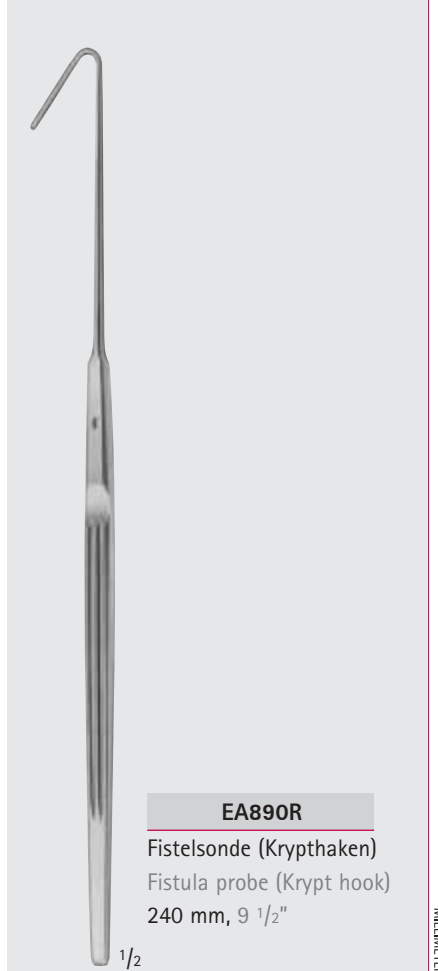

**EA890R**

Fistelsonde (Krypthaken)  
Fistula probe (Krypt hook)  
240 mm, 9 1/2"



MILLIMETERS

## Abdominale Chirurgie – Abdominal Surgery

Biopsiezangen für Rektum

Biopsy Forceps for Rectum

EA

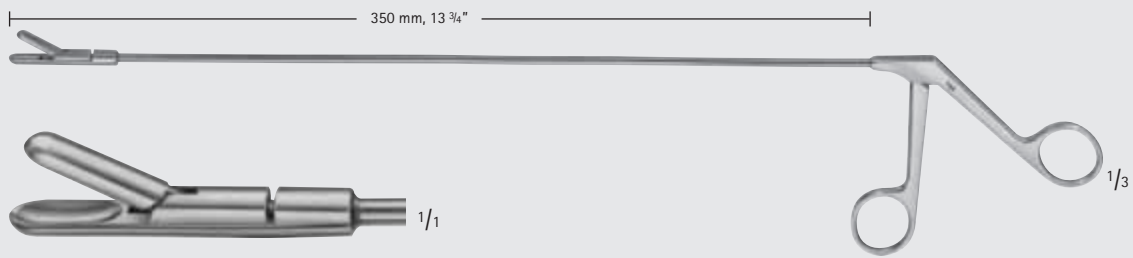

LLOYD-DAVIS

EA900R

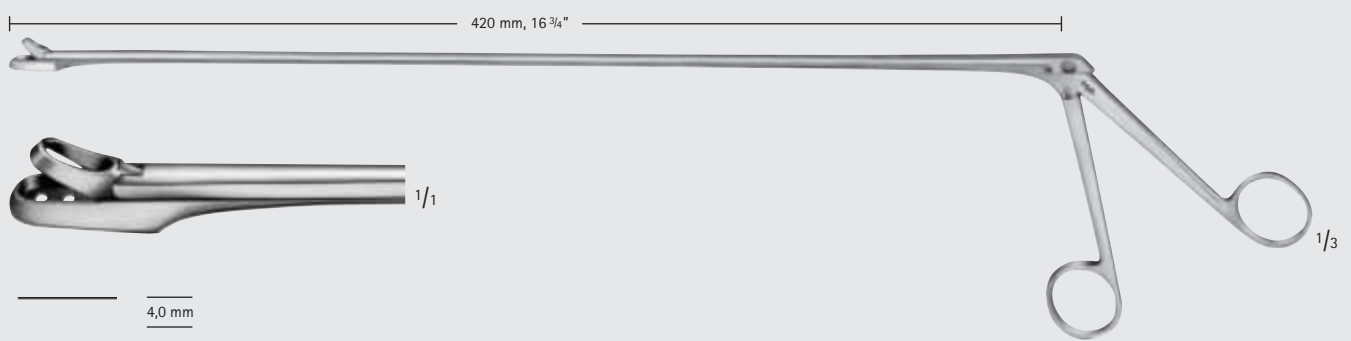

YEOMAN

EA903R





## Abdominale Chirurgie – Abdominal Surgery

### Biopsiezangen für Rektum Biopsy Forceps for Rectum

EA

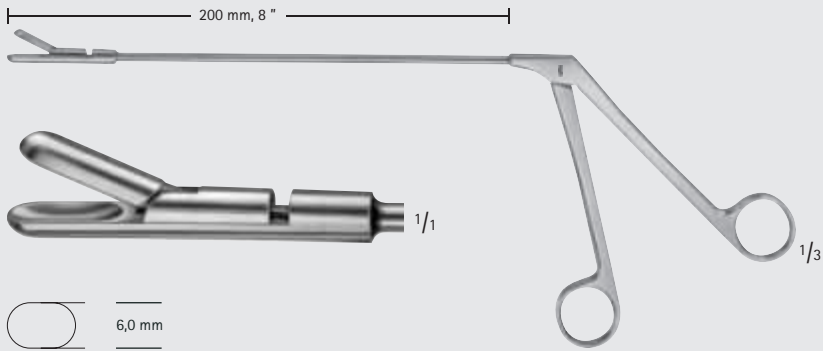

WALTON

**EA904R**

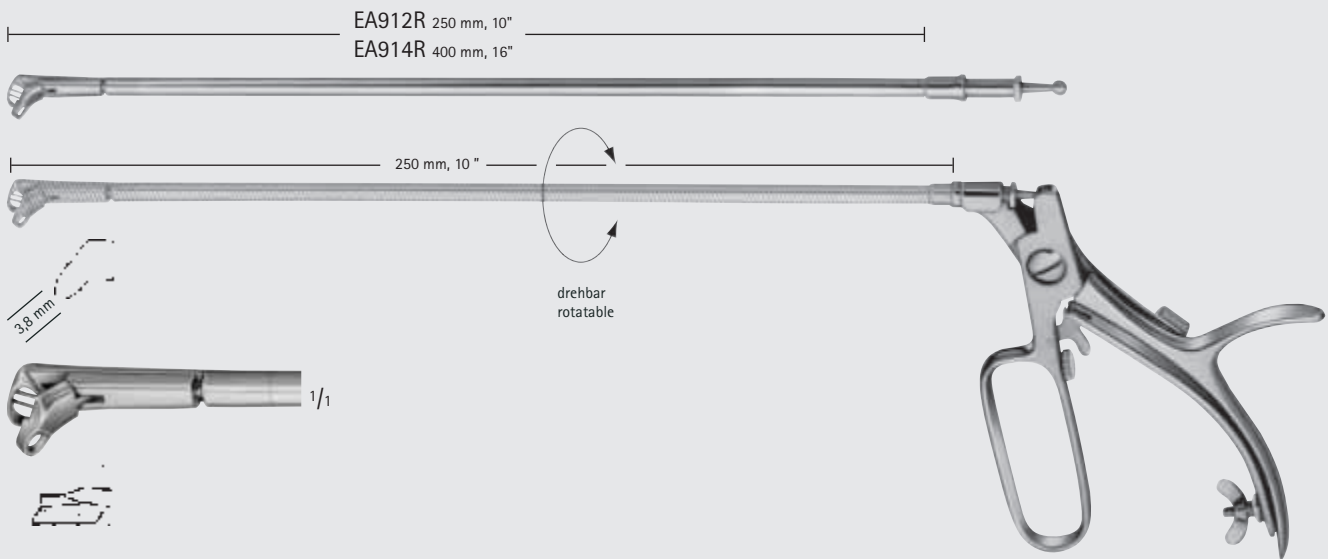

AESCULAP

**OP151R**

Griff für EA912R – EA914R  
Handle for EA912R – EA914R  
140 mm, 5 1/2"

**EA912R-EA914R**

Aufsätze allein  
mit ziehendem Schnitt  
Attachments only  
with cut beginning  
from the top

EA914R	EA912R
400 mm	250 mm
16"	10"

## Abdominale Chirurgie – Abdominal Surgery

Biopsiezangen und Tamponhalter für Rektum

Biopsy Forceps and Swab Holders for Rectum

EA

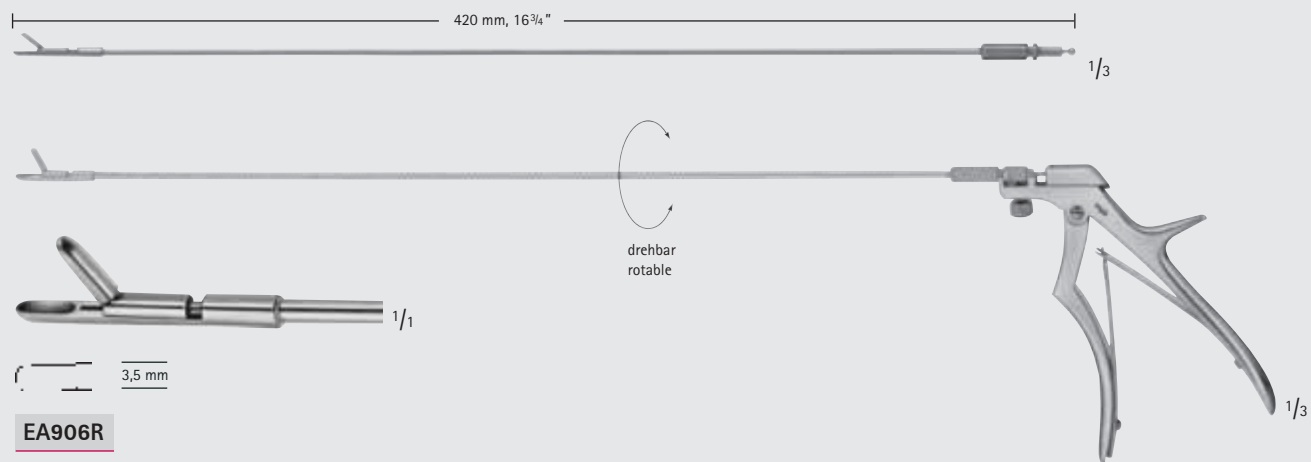

**EA905R**

Griff für  
EA906R - EA909R  
Handle  
for EA906R - EA909R

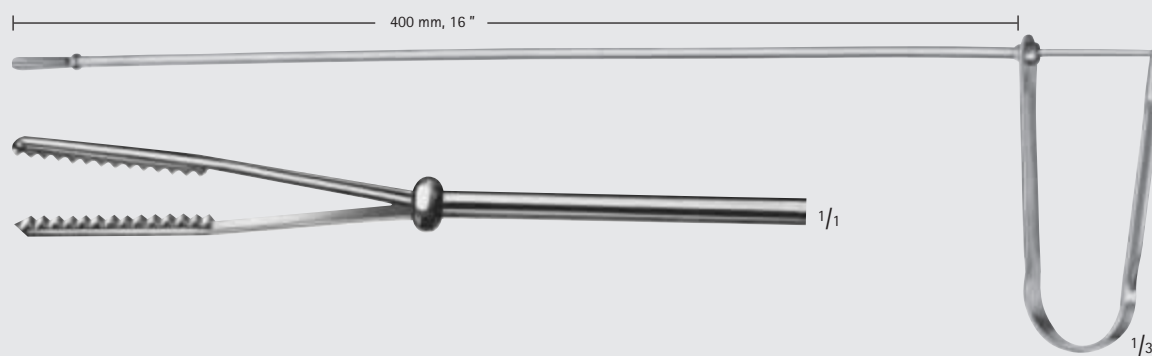
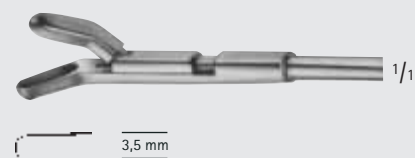

AESCULAP

**EA943R**

Tamponhalter  
Swab holder



**Abdominale Chirurgie – Abdominal Surgery**  
Hämorrhoidenklemmen  
Hemorrhoidal Forceps

EA

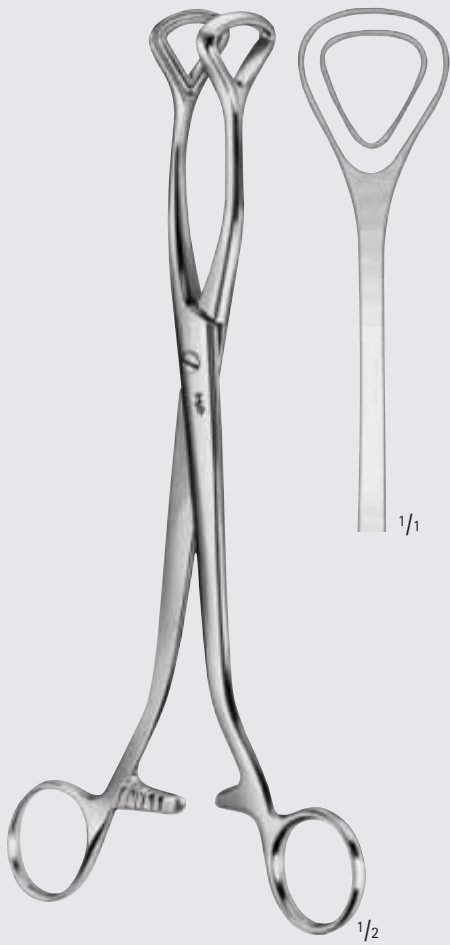

LUER

**EA989R**

245 mm, 9 3/4"

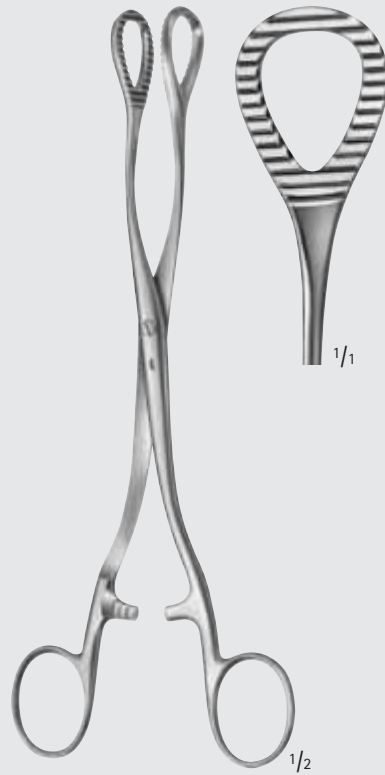

HEYWOOD-SMITH

**AN710R**

200 mm, 8"

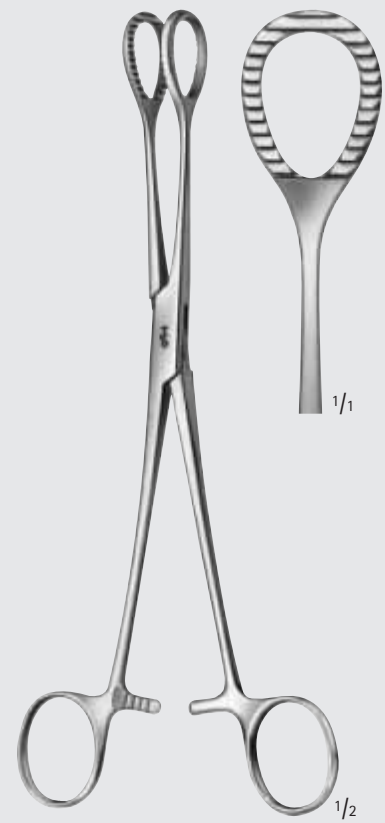

HEYWOOD-SMITH MODIF.

**AN711R**

215 mm, 8 1/2"

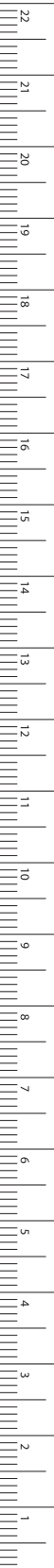

MILLIMETERS

# Abdominale Chirurgie – Abdominal Surgery

Hämorrhoidenklemmen

Hemorrhoidal Forceps

EA



AIRAUMATA®



**E0338R**

250 mm

10"



**E0340R**

270 mm

10 3/4"

**E0338R-E0340R**



**VC100R**

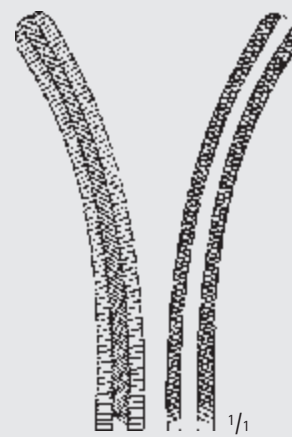

**VC101R**

**FERGUSON**

**VC100R-VC101R**

Druckklemmen  
Pressure clamps

200 mm, 8"



## Abdominale Chirurgie – Abdominal Surgery

### Hämorrhoidal-Ligator Hemorrhoidal Ligator

EA



RUDD

**EA991R**

Hämorrhoidal-Ligator  
mit Lade-Aufsatz und  
100 Ligatur-Gummiringen  
Hemorrhoidal ligator  
with loading attachment  
and 100 ligature rubber rings  
315 mm, 12 1/2"



MC GIVNEY

**EA990R**

Hämorrhoiden-Fasszange  
Hemorrhoidal forceps  
185 mm, 7 1/4"



**EA993**

Ligatur-Gummiringe  
Bestelleinheit:  
PAK = Packung à 100 Stück  
Ligature rubber rings  
Sales Unit:  
PAK = Package of 100 pieces



MILLIMETERS

## Abdominale Chirurgie – Abdominal Surgery

Hämorrhoidal-Ligator

Hemorrhoidal Ligator

EA

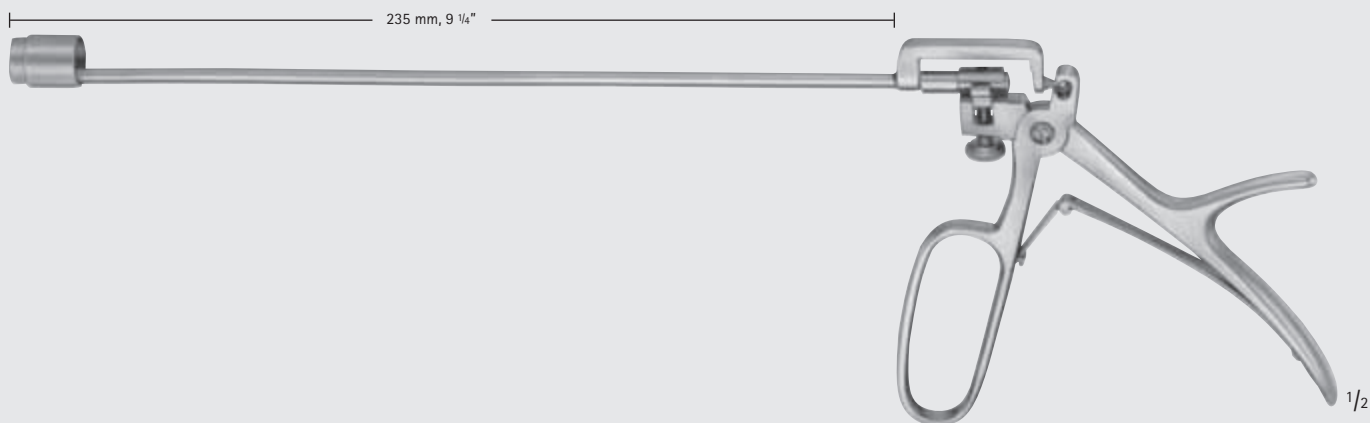

BARRON

### EA996R

Hämorrhoidal-Ligator, komplett

bestehend aus:

EA997R Schaft, allein

EA998R Universal-Handgriff

EA999P Ladekonus

Hemorrhoidal ligator, complete

consisting of:

EA997R Shaft, only

EA998R Universal handle

EA999P Conical loader

Passende Ligatur-Gummiringe: EA993 (siehe Seite 585)

Suitable ligature rubber rings: EA993 (see page 585)



## Abdominale Chirurgie – Abdominal Surgery

Hämorrhoidal-Spritze, Hämorrhoidal-Kanüle  
Hemorrhoidal Syringe, Hemorrhoidal Cannula

EA



GABRIEL

**SF462**

Hämorrhoidal-Spritze  
Hemorrhoidal syringe  
10 ml

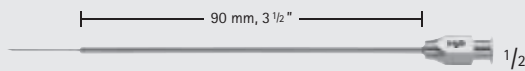

GABRIEL

**SF835**

Hämorrhoidal-Kanüle, gerade,  
mit Luer-Lock-Ansatz  
Hemorrhoidal cannula, straight,  
with Luer-Lock attachment

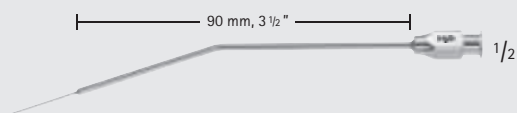

GABRIEL

**SF836**

Hämorrhoidal-Kanüle, abgewinkelt,  
mit Luer-Lock-Ansatz  
Hemorrhoidal cannula, angled,  
with Luer-Lock attachment

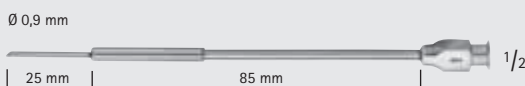

**SF818R**

Hämorrhoiden-Kanüle, mit  
Luer-Lock-Ansatz  
Hemorrhoidal cannula,  
with Luer-Lock attachment





INCHES



EB



**Instrumente für Galle, Leber und Milz**

Gall Bladder-, Liver- and Spleen Instruments

## Instrumente für Galle, Leber – Gall Bladder-, Liver-Instruments

Gallenkanal-Klemmzangen

Gall Duct Forceps

Klemmen nach OVERHOLT siehe Rubrik BJ

OVERHOLT Forceps see section BJ

EB





## Instrumente für Galle, Leber – Gall Bladder-, Liver-Instruments

### Gallenkanal-Klemmzangen Gall Duct Forceps

Klemmen nach OVERHOLT siehe Rubrik BJ  
OVERHOLT Forceps see section BJ

EB



DESJARDINS

**EB008R**

Gallenkanal- und Cystikusklamme  
Gall duct- and cystic forceps  
220 mm, 8 3/4"

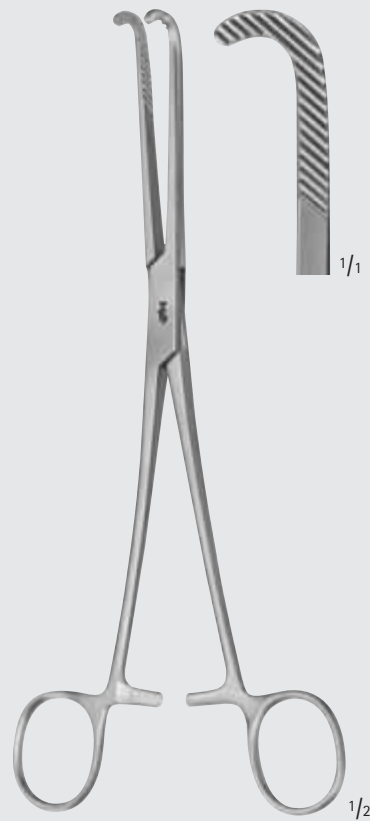

NISSEN

**EB009R**

Gallenkanal- und Cystikusklamme  
Gall duct- and cystic forceps  
215 mm, 8 1/2"



MILLIMETERS

## Instrumente für Galle, Leber – Gall Bladder-, Liver-Instruments

Gallenkanal-Klemmzangen

Gall Duct Forceps

EB



MOYNIHAN

**BH831R-BH833R**

**BH831R**

230 mm

9"

**BH833R**

240 mm

9 1/2"

1/1

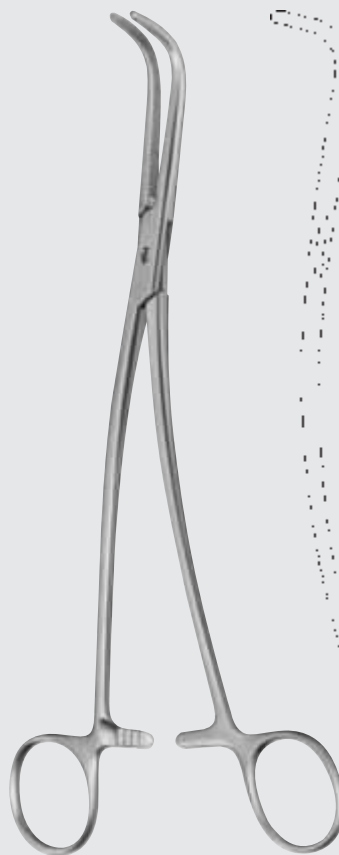

GRAY

**EB011R-EB012R**

Cholecystektomieklammen

Cholecystectomy forceps

220 mm, 8 3/4"

**EB011R**

**EB012R**

1/1

1/2

1/2



**Instrumente für Galle, Leber – Gall Bladder-, Liver-Instruments**  
Gallenkanal-Klemmzangen  
Gall Duct Forceps

**EB**

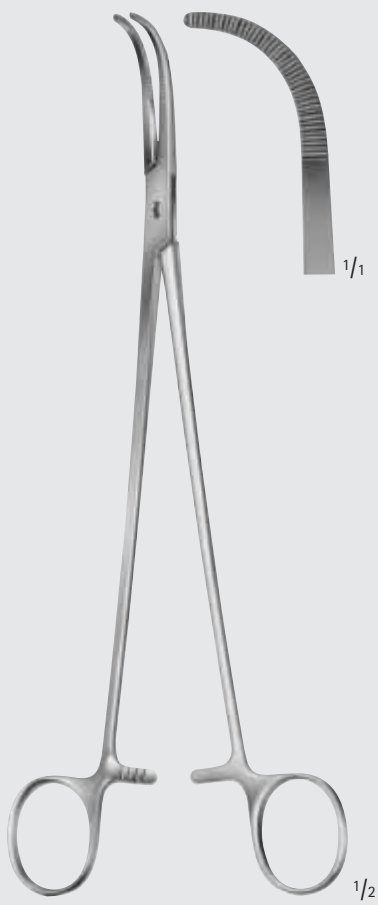

MIXTER

**BJ055R**

Gallenkanal- und Cystikusklammer  
Gall duct- and cystic forceps  
230 mm, 9"



MILLIMETERS

## Instrumente für Galle, Leber – Gall Bladder-, Liver-Instruments

Gallenblasenzangen

Gall Bladder Forceps

EB



BF122R

BF123R

FOERSTER-BALLENGER

BF122R-BF123R

245 mm, 9 3/4"

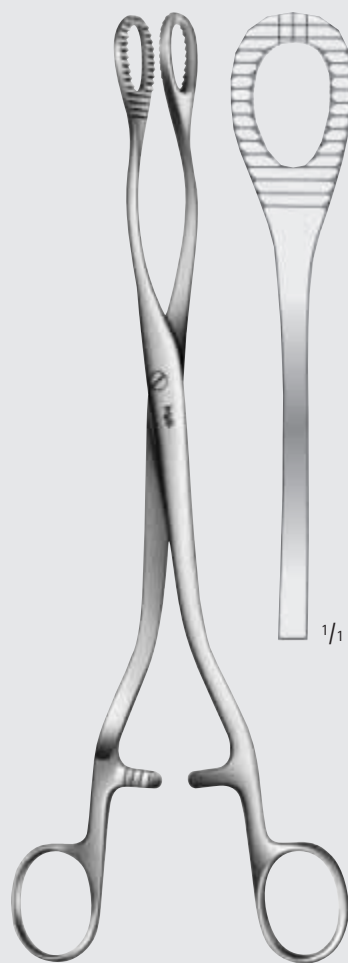

HEYWOOD-SMITH

E0310R

250 mm, 10"



**Instrumente für Galle, Leber – Gall Bladder-, Liver-Instruments**  
Gallenblasenzangen  
Gall Bladder Forceps

**EB**

**AIRAUMATA®**



**E0338R**  
250 mm  
10"

**E0340R**  
270 mm  
10 3/4"

**E0338R-E0340R**

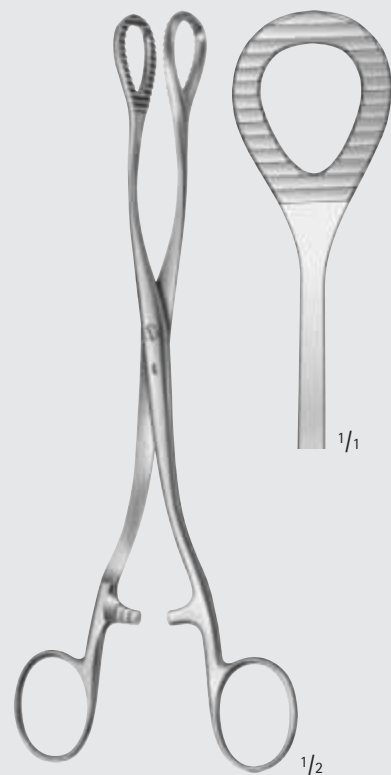

**HEYWOOD-SMITH**

**AN710R**

200 mm, 8"



MILLIMETERS

## Instrumente für Galle, Leber – Gall Bladder-, Liver-Instruments

Gallenblasenzangen und Gallengangscheren

Gall Bladder Forceps and Gall Duct Scissors

EB

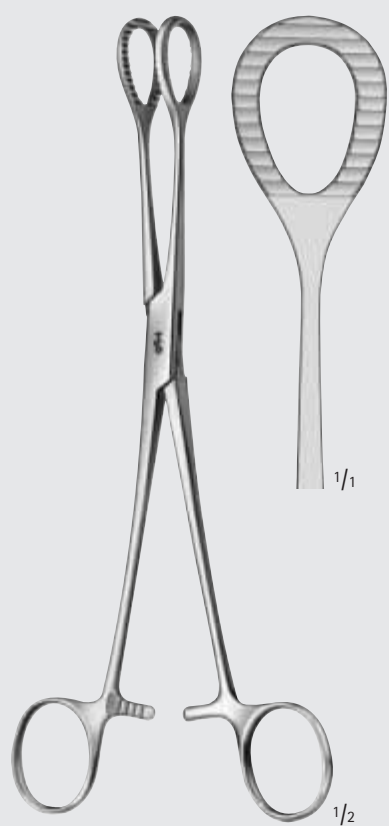

HEYWOOD-SMITH MODIF.

**AN711R**

215 mm, 8 1/2"

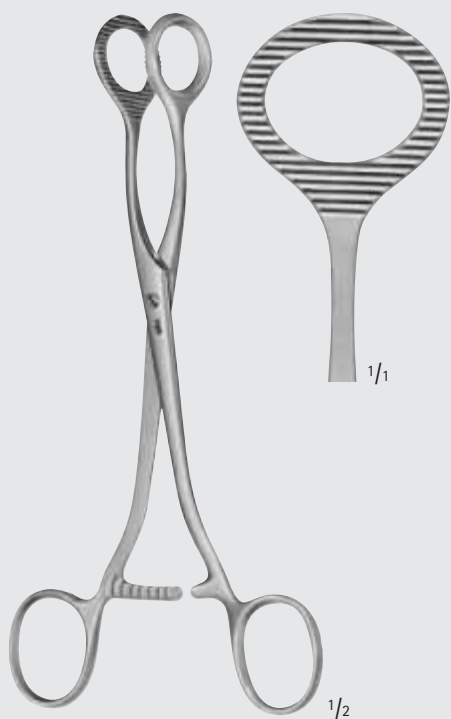

DOYEN

**E0332R**

185 mm, 7 1/4"

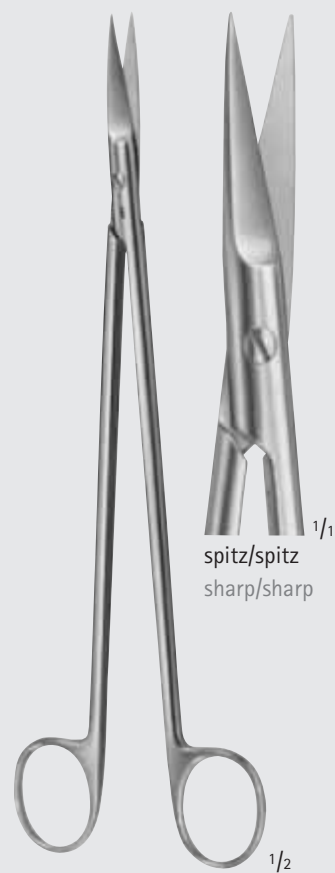

spitz/spitz  
sharp/sharp

**BC642R**

zur Eröffnung  
der Gallenblase  
for opening the  
gall bladder  
225 mm, 9"





**Instrumente für Galle, Leber – Gall Bladder-, Liver-Instruments**  
Gallengangsscheren  
Gall Duct Scissors

**EB**



MILLIMETERS



POTTS-DE MARTEL

**BC650R**

60°

MILLS <sup>1/1</sup>

**BC651R**

60°

<sup>1/2</sup>

**BC650R-BC651R**

220 mm, 8 <sup>3/4</sup>"

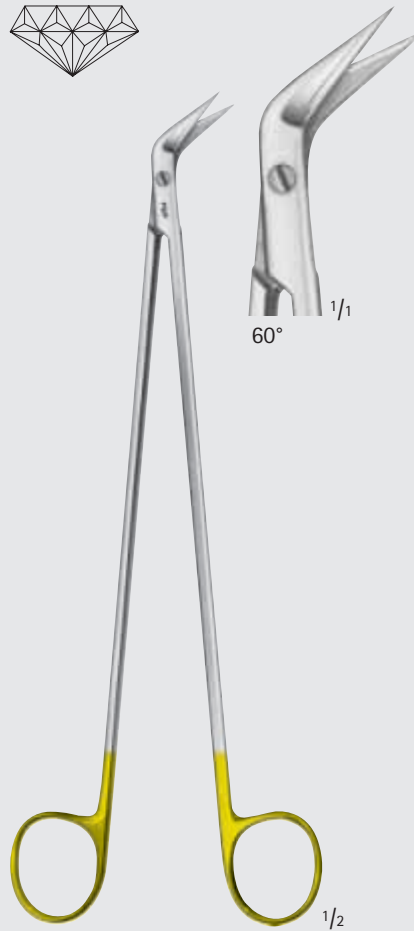

60°

<sup>1/1</sup>

<sup>1/2</sup>

DE BAKEY

**BC245R**

220 mm, 8 <sup>3/4</sup>"

## Instrumente für Galle, Leber – Gall Bladder-, Liver-Instruments

### Gallengangsonden

#### Gall Duct Probes

EB



Knopf-Ø 3,5 mm  
Diam. of tip 3.5 mm



HAJEK

**OK900**

Spülkanüle, aus Silber  
Irrigating cannula, silver  
165 mm, 6 1/2"

Knopf-Ø 5 mm  
Diam. of tip 5 mm



MOYNIHAN

**EB050**

Gallensteinsonde und -löffel  
aus Zinn, biegsam  
Gall stone probe and -scoop  
of tin, malleable  
365 mm, 14 1/2"

Knopf-Ø 5 mm  
Diam. of tip 5 mm



MAYO

**E0005R**

Gallengangsonde, biegsam  
Gall duct probe, malleable  
330 mm, 13 1/8"



# Instrumente für Galle, Leber – Gall Bladder-, Liver-Instruments

Gallengansonden  
Gall Duct Probes

Knopf-Ø 3,5 mm  
Diam. of tip 3.5 mm

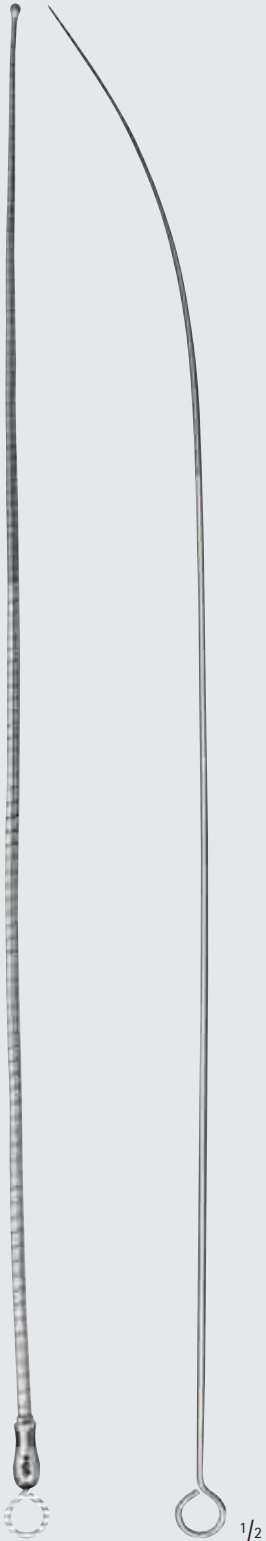

OCHSNER

**EB052C**

Gallengangsonde, federnd  
Gall duct probe, flexible  
400 mm, 16"



	EB101R	EB102R	EB103R
Knopf-Ø	3,8 mm	5,3 mm	6,8 mm
Diam. of tip	3.8 mm	5.3 mm	6.8 mm

DESJARDINS

**EB101R-EB103R**

Gallengangsonden, federnd  
Gall duct probes, flexible  
285 mm, 11 1/4"

EB

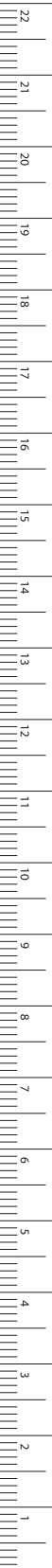

MILLIMETERS

## Instrumente für Galle, Leber – Gall Bladder-, Liver-Instruments

Gallengangdilatatoren

Gall Duct Dilators

EB



1/2

Charr. (French)

EF638R	8
EF639R	9
EF640R	10
EF641R	11
EF642R	12
EF643R	13
EF644R	14
EF645R	15
EF646R	16
EF647R	17
EF648R	18
EF649R	19
EF650R	20
EF651R	21
EF652R	22
EF653R	23
EF654R	24
EF655R	25
EF656R	26
EF657R	27
EF658R	28
EF659R	29
EF660R	30

DITTEL

EF638R-EF660R

Metallbougie-Öffner

Metal bougies

and dilating sounds

345 mm, 13 3/4"

# Instrumente für Galle, Leber – Gall Bladder-, Liver-Instruments

## Gallengangdilatoren Gall Duct Dilators

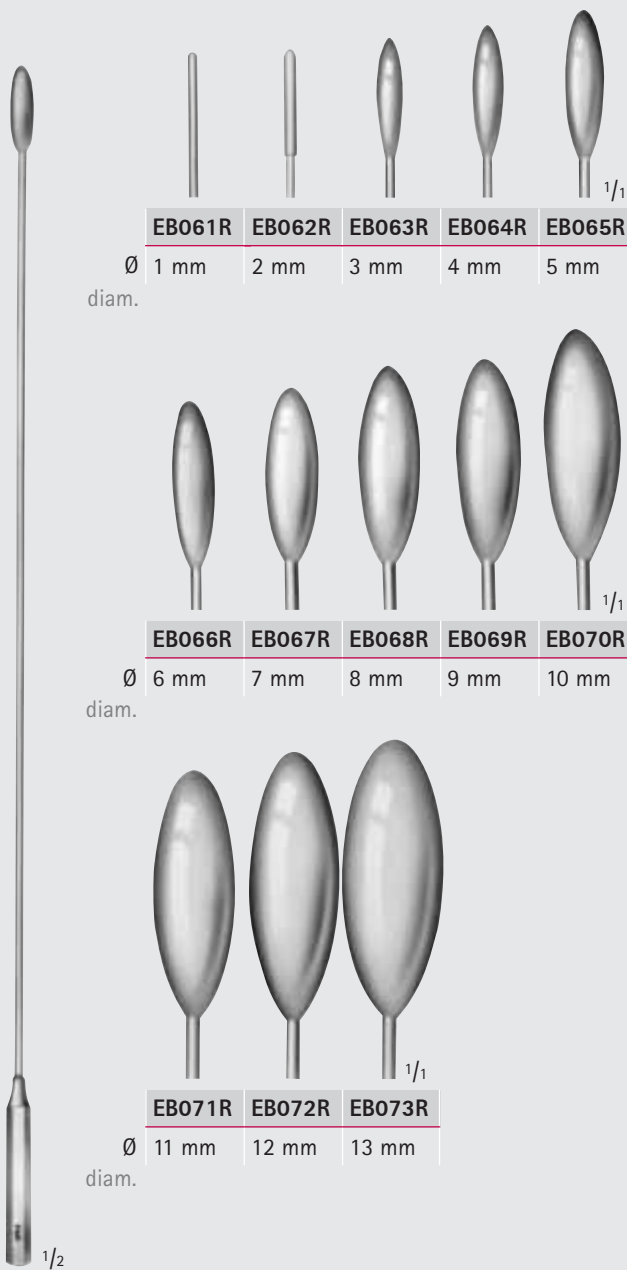
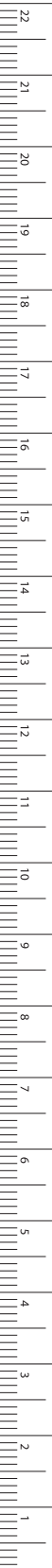

BAKES

### EB061R-EB073R

Gallengangdilations Oliven,  
biegsam

Common bile duct dilators,  
malleable

EB061R-EB065R 315 mm, 12 1/2"

EB066R-EB073R 320 mm, 12 3/4"

### EB074R

Satz à 9 Stück EB063R - EB071R,  
in Leinentasche

Set of 9 pieces EB063R - EB071R,  
in canvas roll

### EB075

Leinentasche allein  
Canvas roll only

## Instrumente für Galle, Leber – Gall Bladder-, Liver-Instruments

### Gallensteinlöffel

### Gall Stone Scoops

geeignete Wundhaken siehe Rubrik BT  
 selbsthaltende Bauchdeckenrahmen siehe Rubrik BV  
 suitable retractors see section BT  
 Self-retaining abdominal retractors see section BV

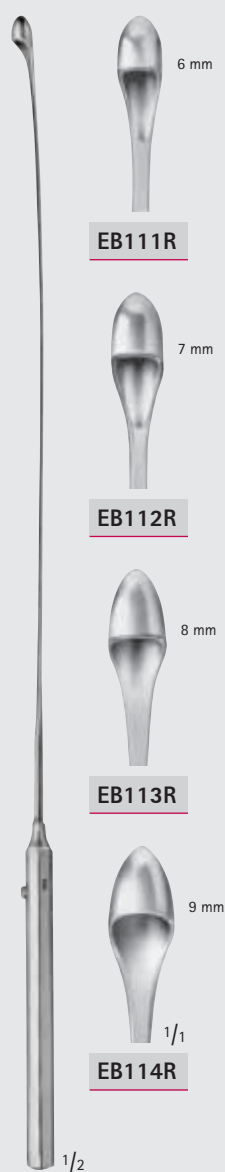

**EB111R**

6 mm

**EB112R**

7 mm

**EB113R**

8 mm

**EB114R**

9 mm

1/2

DESJARDINS

**EB111R-EB114R**

Sonde und Fänger mit federndem Schaft  
 Probe and catch with flexible shaft  
 300 mm, 12"

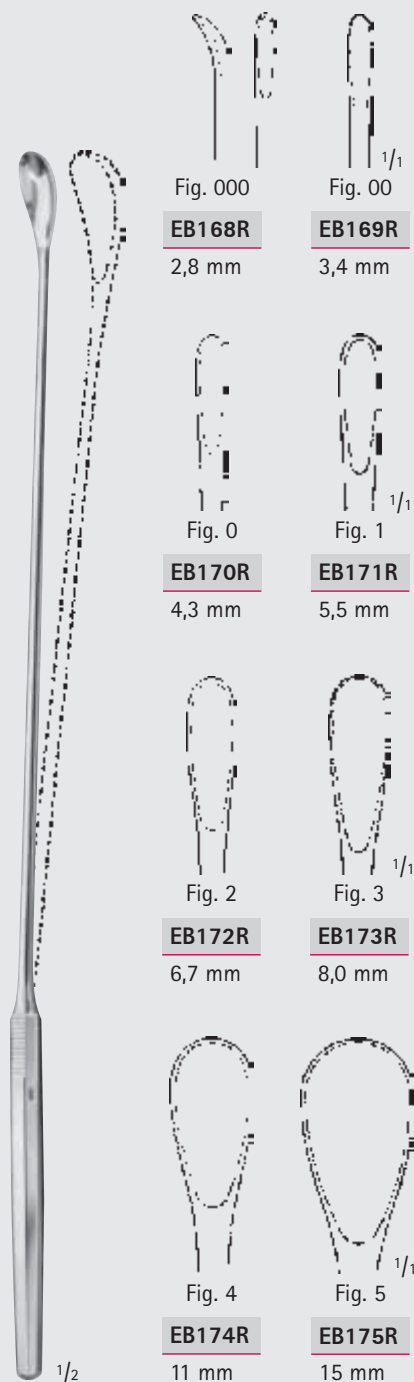

Fig. 000

**EB168R**  
2,8 mm

Fig. 00

**EB169R**  
3,4 mm

Fig. 0

**EB170R**  
4,3 mm

Fig. 1

**EB171R**  
5,5 mm

Fig. 2

**EB172R**  
6,7 mm

Fig. 3

**EB173R**  
8,0 mm

Fig. 4

**EB174R**  
11 mm

Fig. 5

**EB175R**  
15 mm

1/2

LUER-KÖRTE MODIF.

**EB168R-EB175R**

mit biegsamen Schaft  
 with malleable shaft  
 325 mm, 12 3/4"



## Instrumente für Galle, Leber – Gall Bladder-, Liver-Instruments

Gallensteinzangen  
Gall Stone Forceps

weitere Gallensteinzangen siehe Rubrik EF  
further gall stone forceps see section EF

EB



BLAKE

**EB220R**

205 mm, 8"

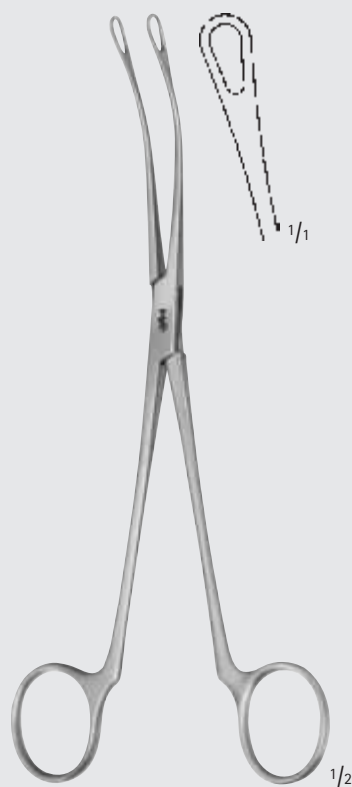

BLAKE

**EB221R**

205 mm, 8"

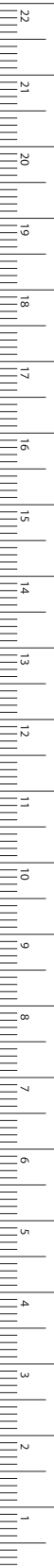

MILLIMETERS

## Instrumente für Galle, Leber – Gall Bladder-, Liver-Instruments

Gallensteinzangen

Gall Stone Forceps

EB

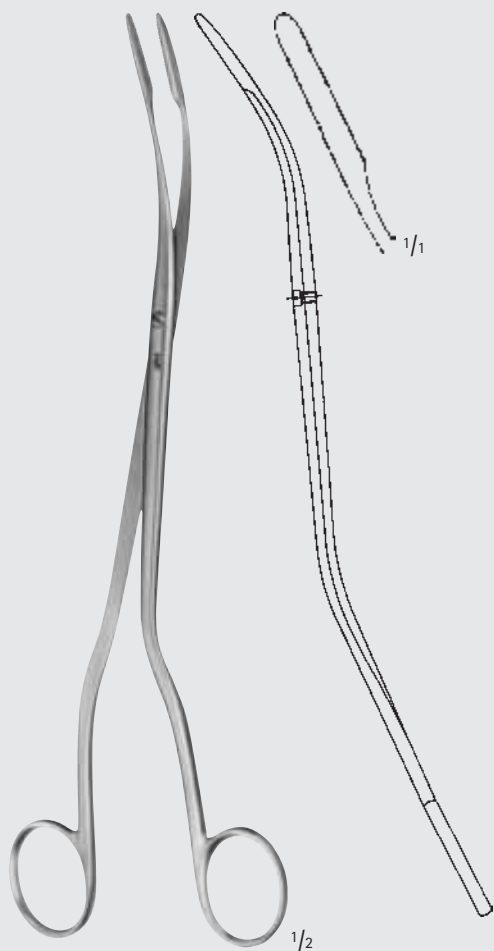

CZERNY

**EB225R**

245 mm, 9 3/4"



PELKMANN

**EO061R**

260 mm, 10 1/4"



## Instrumente für Galle, Leber – Gall Bladder-, Liver-Instruments

Gallensteinzangen  
Gall Stone Forceps

**EB**



**EB231R**

**EB232R**



**EB233R**

**EB234R**

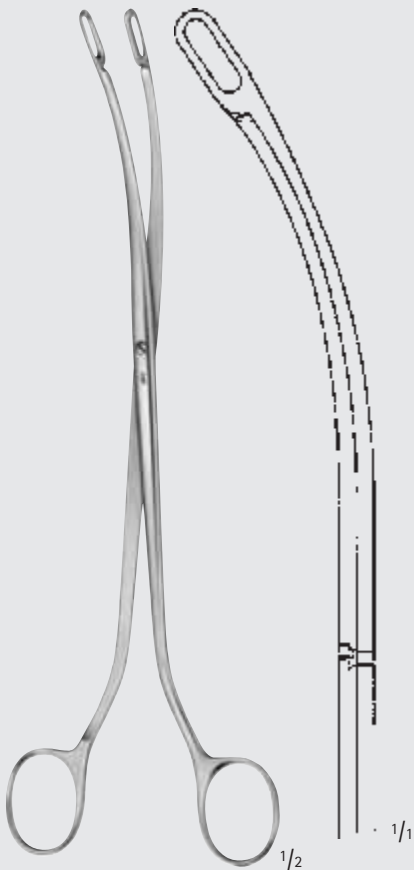

DESJARDINS

**EB231R-EB233R**

225 mm, 9"



**EB240R**

240 mm

9 1/2"



DESJARDINS

**EB240R-EB242R**

besonders schmale Modelle  
extremely delicate patterns

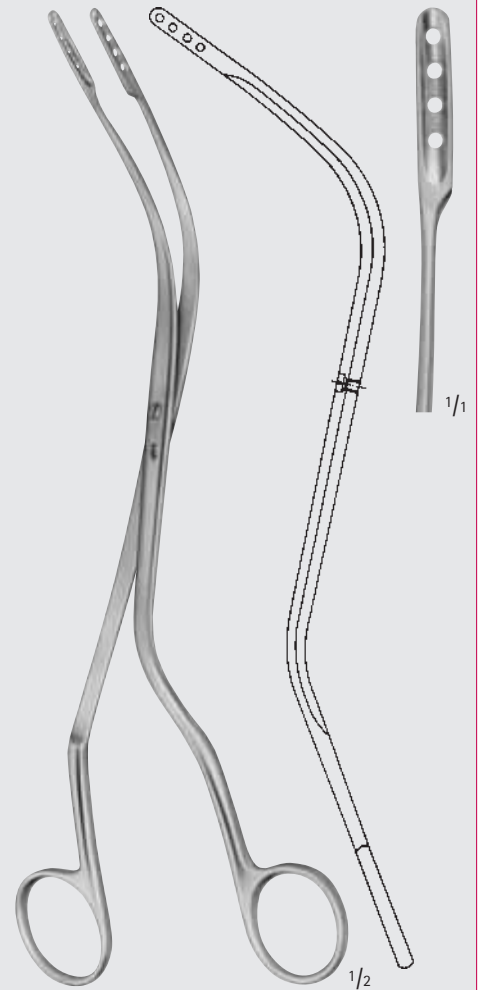

TÜBINGER MODELL

**EB239R**

255 mm, 10"





INCHES



EF

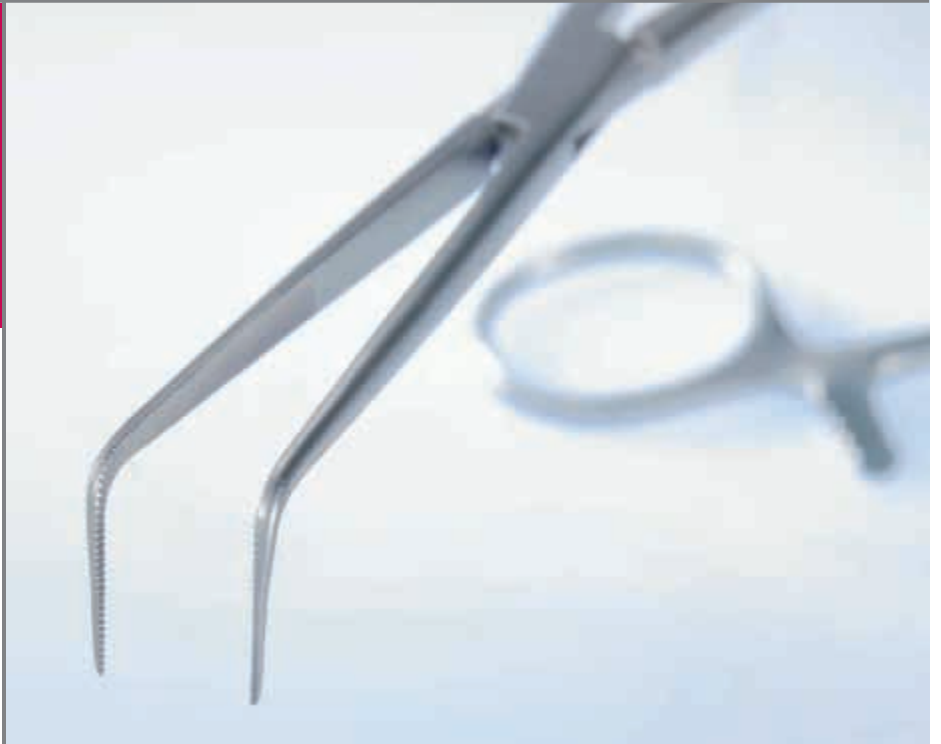

**Urologie-Instrumente**  
Genito-Urinary Instruments

# Urologie-Instrumente – Genito-Urinary Instruments

Nierenklemmen

Kidney Clamps

EF



**AIRAUMATA®**



**EF001R**  
240 mm  
9 1/2"



**EF002R**  
230 mm  
9"



**EF003R**  
230 mm  
9"

GUYON

**EF001R-EF003R**



GUYON

**EF011R**

230 mm, 9"



## Urologie-Instrumente – Genito-Urinary Instruments

Nierenklemmen

Kidney Clamps

EF

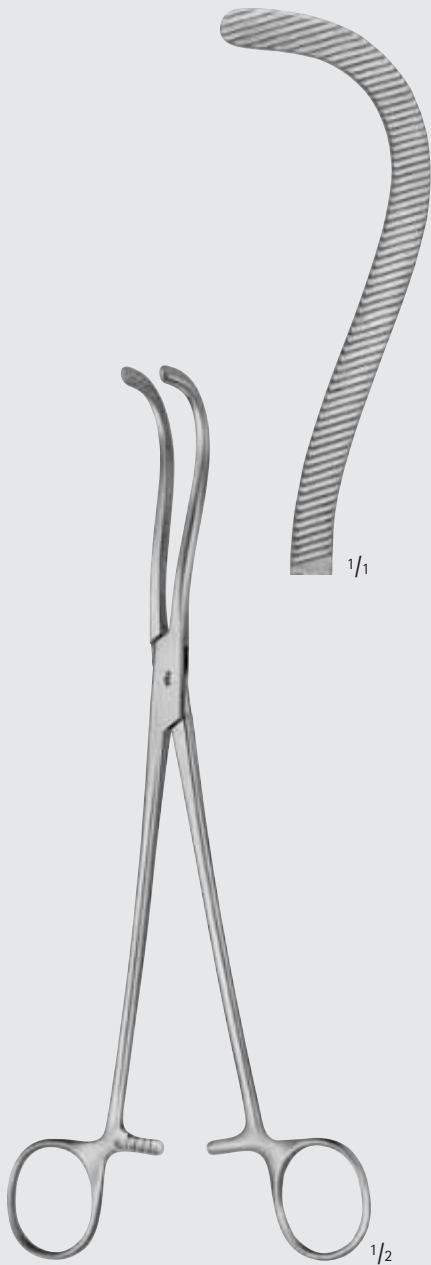

GUYON

**EF010R**

235 mm, 9 1/4"

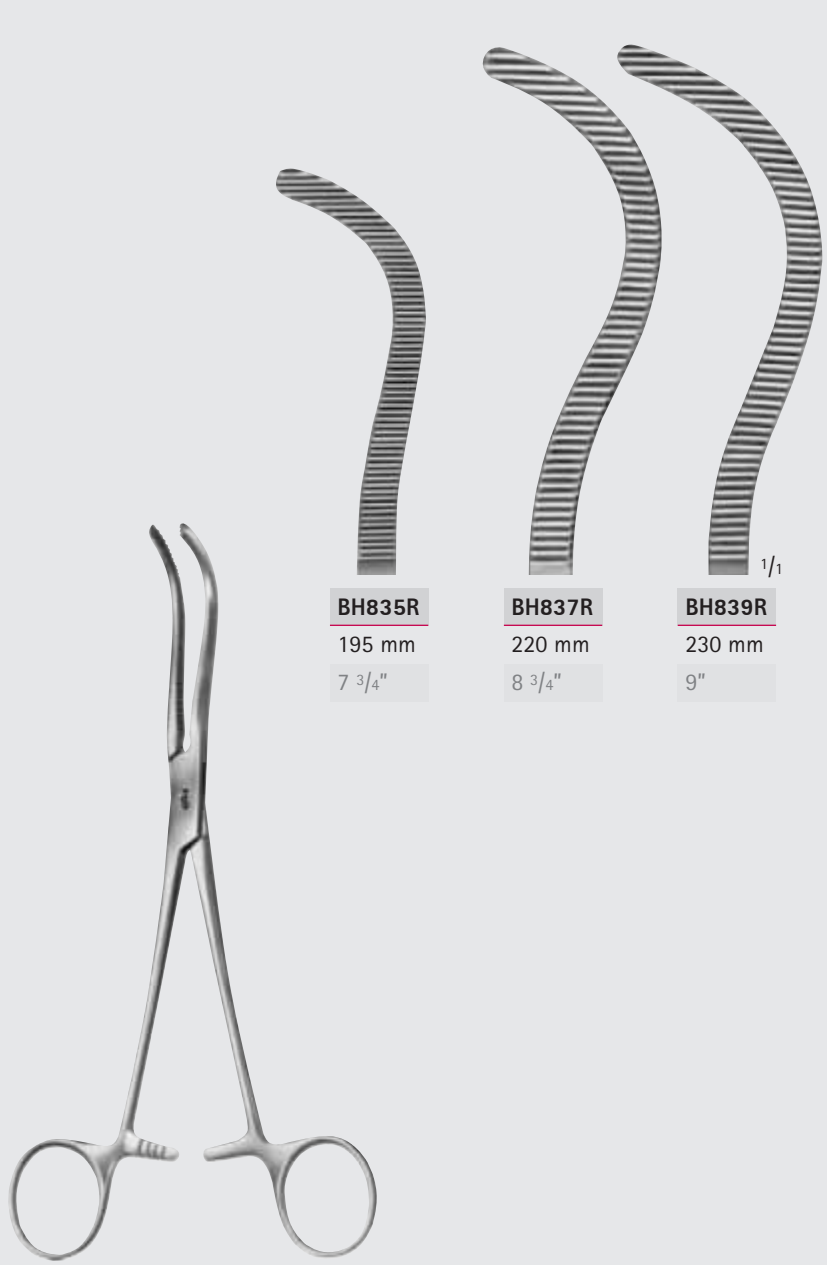

**BH835R**

195 mm

7 3/4"

**BH837R**

220 mm

8 3/4"

**BH839R**

230 mm

9"

PEAN

**BH835R-BH839R**



MILLIMETERS

# Urologie-Instrumente – Genito-Urinary Instruments

## Nierenklemmen

### Kidney Clamps

EF

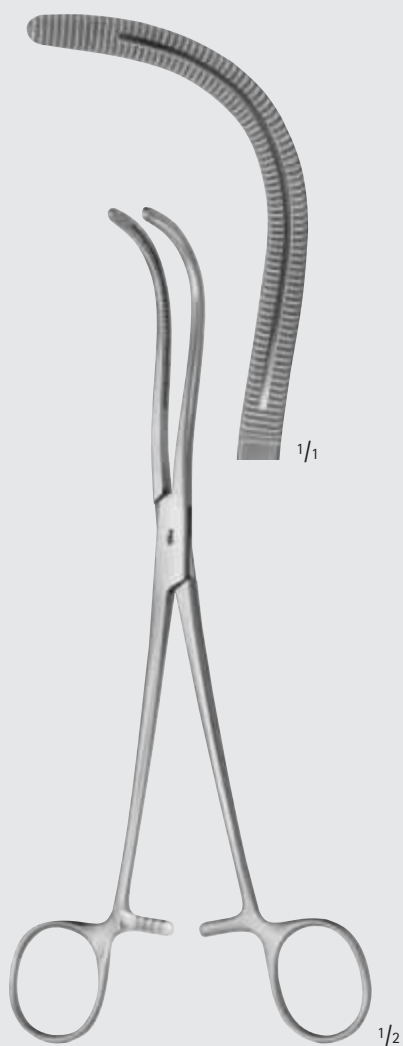

STILLE

EF016R

220 mm, 8 3/4"



STILLE

EF015R

240 mm, 9 1/2"

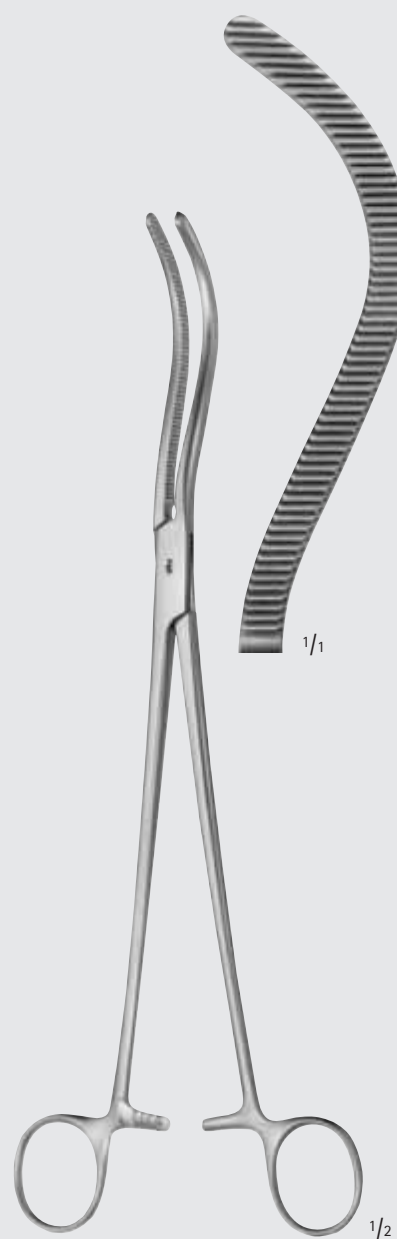

GUYON

EF012R

265 mm, 10 1/2"



## Urologie-Instrumente – Genito-Urinary Instruments

Nierenstielklemmen  
Kidney Pedicle Clamps

EF



HERRICK

EF030R

225 mm, 9"



WERTHEIM

BJ574R

255 mm, 10"

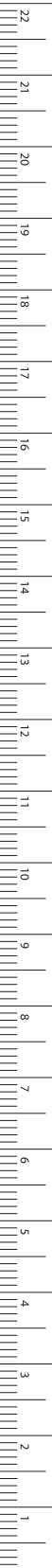

MILLIMETERS

## Urologie-Instrumente – Genito-Urinary Instruments

Nierenstielklemmen

Kidney Pedicle Clamps

AIRAUMATA®



WERTHEIM-CULLEN

**BJ579R**

Winkel- und Druckklemme  
Angle- and pressure clamp

215 mm, 8 1/2"



WERTHEIM

**BJ581R**

Winkel- und Druckklemme  
Angle- and pressure clamp

250 mm, 10"

EF







## Urologie-Instrumente – Genito-Urinary Instruments

Nierenfasszangen  
Kidney Elevating Forceps

EF



COLLIN

**EO405R**

285 mm, 11 1/4"



DARTIGUES

**EO407R**

255 mm, 10"

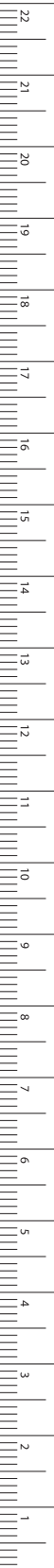

MILLIMETERS

## Urologie-Instrumente – Genito-Urinary Instruments

### Nierensteinzangen

### Kidney Stone Forceps

EF



**EF047R**

170 mm

6 <sup>3</sup>/<sub>4</sub>"

**EF048R**

160 mm

6 <sup>1</sup>/<sub>4</sub>"

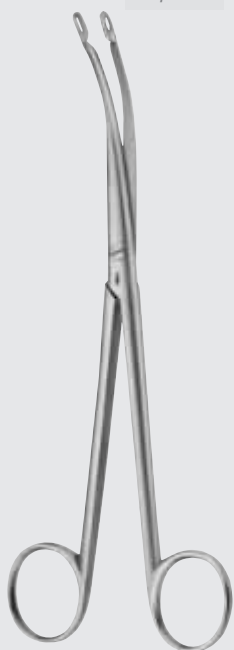

**HEIMING**

**EF047R-EF048R**

für Kinder  
for children



**EF051R**

**EF052R**

**EF053R**

**EF054R**

**RANDALL**

**EF051R-EF054R**

225 mm, 9"



## Urologie-Instrumente – Genito-Urinary Instruments

Nierensteinzangen  
Kidney Stone Forceps

EF



EF055R



EF056R



RANDALL

EF055R-EF056R

190 mm, 7 1/2"



MILLIMETERS

## Urologie-Instrumente – Genito-Urinary Instruments

Nierensteinzangen

Kidney Stone Forceps

EF



**EB244R**

245 mm

9 3/4"



**EB246R**

230 mm

9"



RANDALL

**EB244R-EB246R**

besonders schmale Modelle  
extremely delicate patterns

 KUGELSCHNELLVERSCHLUSS  
BALL SNAP CLOSURE



BV576R



BV577R

### MILLIN

#### **BV580R**

Blasenwundspreizer komplett,  
bestehend aus:

- BV575R Sperrer allein
- BV576R Blätter 57 x 25 mm
- BV577R Blätter 82 x 25 mm
- BV578R Mittelblatt 105 x 45 mm

Bladder retractor complete,  
consisting of:

- BV575R Spreader only
- BV576R Blades 57 x 25 mm
- BV577R Blades 82 x 25 mm
- BV578R Center blade 105 x 45 mm

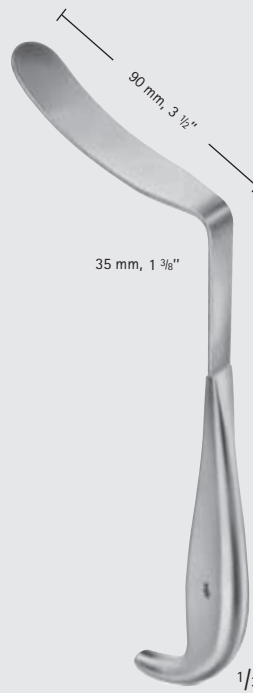

### LEGUEU

#### **BV928R**

Blasenspatel  
Bladder spatula  
260 mm, 10 1/4"

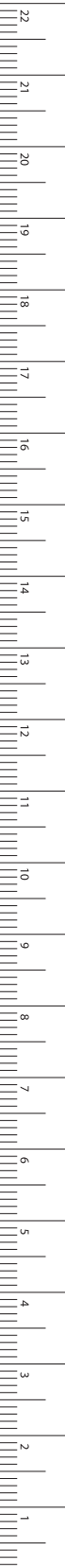

MILLIMETERS

## Urologie-Instrumente – Genito-Urinary Instruments

Urologie – Prostatektomie

Genito-Urinary Instruments – Prostatectomy

EF



BARRÉ

**BB176R-BB178R**

No. 3 XL  
für linke Hand  
for left hand  
250 mm, 10"



**BB176R**

12°



**BB178R**

25°

1/1



BARRÉ

**BB177R**

No. 3 XL  
für linke Hand  
for left hand  
250 mm, 10"



BARRÉ

**BC715R**

Präparierschere  
Dissecting scissors  
280 mm, 11"



spitz/spitz  
sharp/sharp



1/1

1/2



## Urologie-Instrumente – Genito-Urinary Instruments

Urologie - Prostatektomie

Genito-Urinary Instruments - Prostatectomy

EF

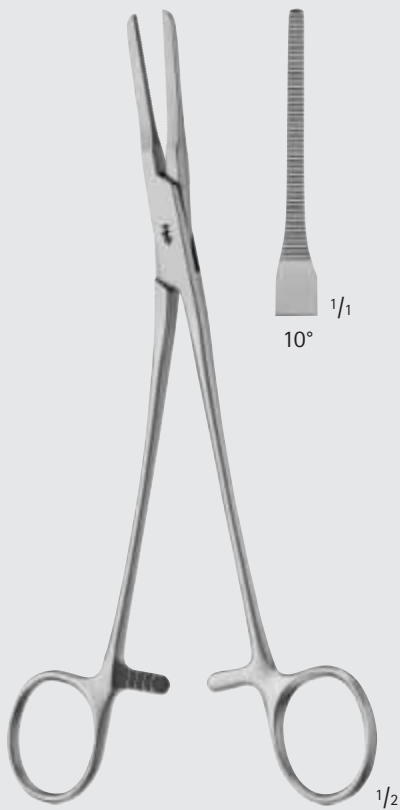

**EF167R**

Venenklemme  
Venous plexus clamp  
210 mm, 8 1/4"



**BJ029R**

extra fein  
extra delicate

**BJ110R**

fein  
delicate

BARRE

**BJ029R-BJ110R**

Präparierklemmen  
Dissecting forceps  
280 mm, 11"



MILLIMETERS

## Urologie-Instrumente – Genito-Urinary Instruments

Urologie - Prostatektomie

Genito-Urinary Instruments - Prostatectomy

EF



BARRÉ

**BT680R**

Prostata-Retraktor  
Prostate retractor

360 mm, 14 3/8"



BARRÉ

**BT681R**

Urethra-Retraktor  
Urethral retractor

390 mm, 15 1/2"



BARRÉ

**GK685R**

Bipolare Pinzette  
Bipolar forceps

260 mm, 10 1/4"





## Urologie-Instrumente – Genito-Urinary Instruments

Urologie - Prostatektomie

Genito-Urinary Instruments - Prostatectomy

EF

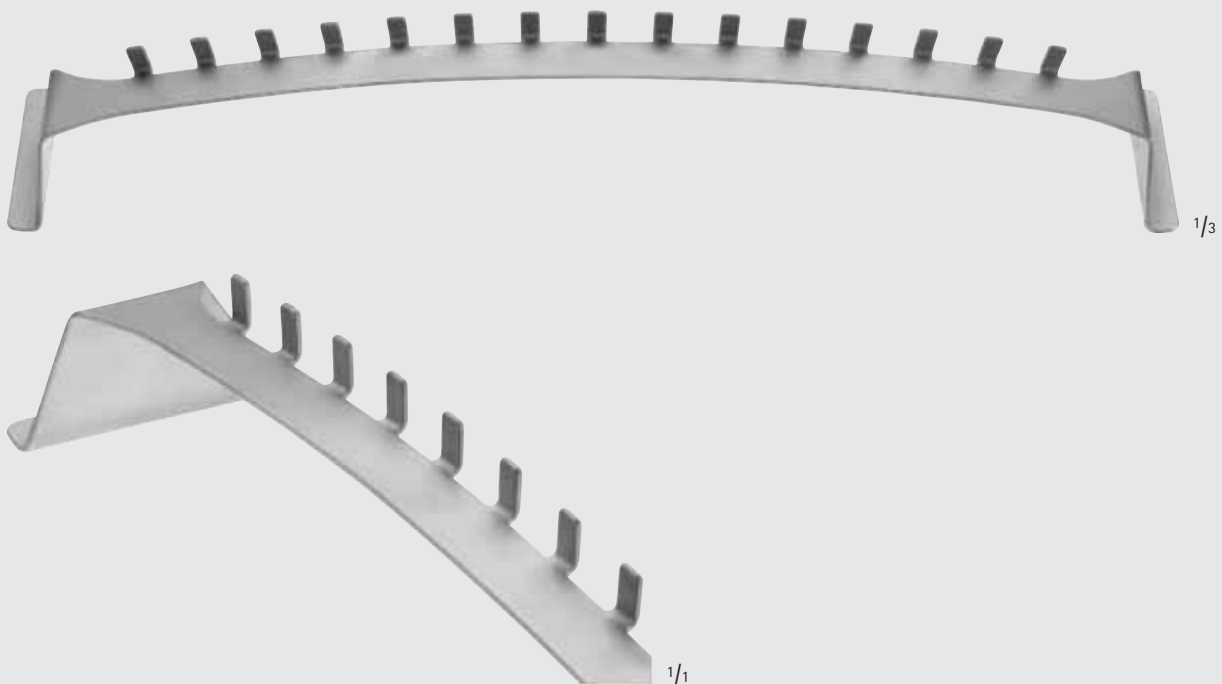

BARRÉ

**BV927R**

Fadenhaltebügel

Suture holding frame

465 mm, 18 1/3"

MILLIMETERS

## Urologie-Instrumente – Genito-Urinary Instruments

Urologie – Prostatektomie

Genito-Urinary Instruments – Prostatectomy

EF

AIRAUMATA®



MILLIN

**EF163R**

Kapselasszange

Lobe grasping forceps

245 mm, 9 3/4"

AIRAUMATA®



MILLIN

**EF164R**

Kapselasszange

Lobe grasping forceps

235 mm, 9 1/4"



MILLIN

**EF168R**

Fadenzhalteasszange

Ligature holding forceps

245 mm, 9 3/4"



MILLIN

**EF170R**

Blasenhalsspreizer

Bladder neck spreader

285 mm, 11 1/4"

INCHES



## Urologie-Instrumente – Genito-Urinary Instruments

Urologie - Prostatektomie

Genito-Urinary Instruments - Prostatectomy

EF



**BM627R**



**BM628R**



**BM629R**

**BM627R-BM629R**

Ersatz-Nadeln  
Spare needles



YOUNG-HRYNTSCHAK

**BM620R**

Bumerang-Nadelhalter  
mit 1 Nadel BM627R  
Boomerang Needle Holder  
with 1 needle BM627R  
240 mm, 9 1/2"

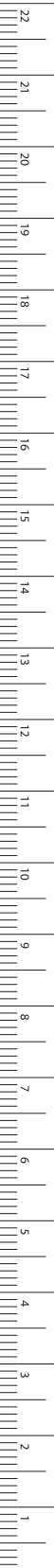

MILLIMETERS

## Urologie-Instrumente – Genito-Urinary Instruments

Urologie-Instrumente

Genito-Urinary Instruments

EF



AIRAUMATA®



EF070R

Ureterzange

Ureter Forceps

240 mm, 9 1/2"

## Urologie-Instrumente – Genito-Urinary Instruments

Urologie-Instrumente  
Genito-Urinary Instruments

EF

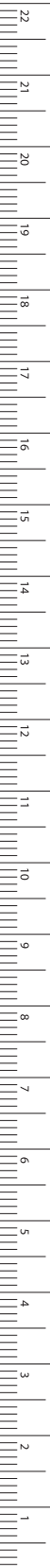

MILLIMETERS



STOCKMANN

**EF400R**

Penisklemme

Penis clamp

70 mm, 2 3/4"



STRAUSS

**EF401R**

Penisklemme

Penis clamp

130 mm, 5 1/8"



**EF155R**

Zange zum Erfassen der  
Glans und der Vorhaut,  
Ring-Ø 4,8 mm

Forceps for grasping the  
glans and the foreskin,  
ring diam. 4.8 mm

125 mm, 5"



**EF195R**

Klemme zum Fixieren  
des Samenstrangs

Fixation clamp for the  
spermatic cord

145 mm, 5 3/4"

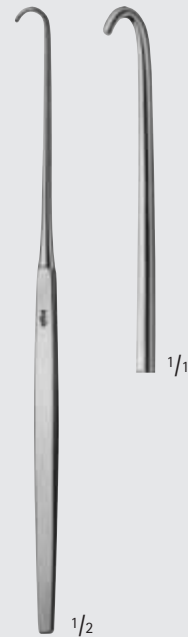

**BT126R**

Haken für den Samenstrang  
Hook for the spermatic cord

165 mm, 6 1/2"

## Urologie-Instrumente – Genito-Urinary Instruments

Urologie-Harnröhre

Genito-Urinary Instruments

EF

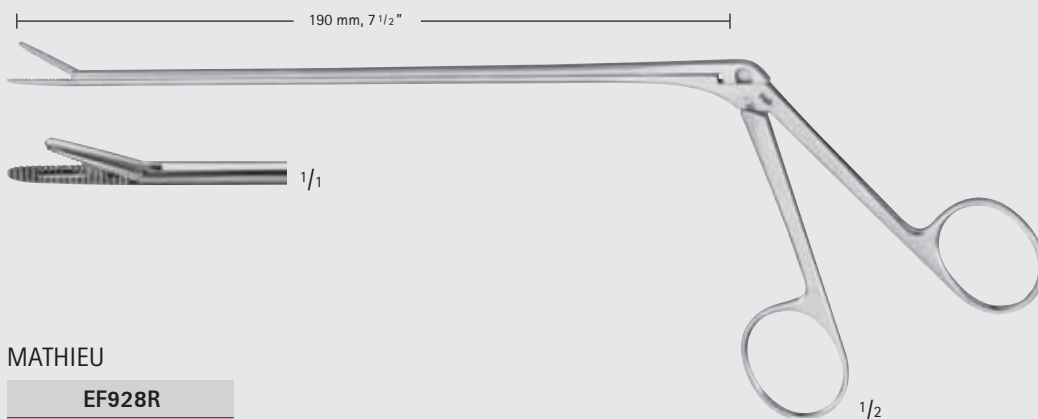

MATHIEU

**EF928R**

Fremdkörperzange

Foreign body forceps

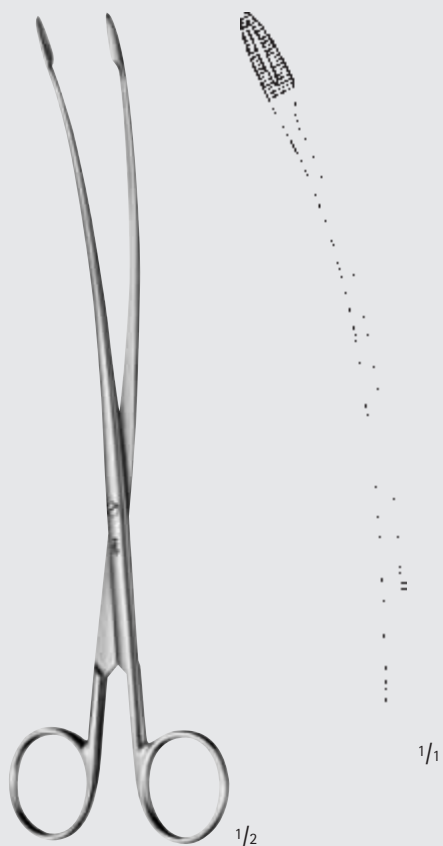

PITHA

**EF921R**

Fremdkörperzange

Foreign body forceps

220 mm, 8 3/4"

biegsam  
malleable

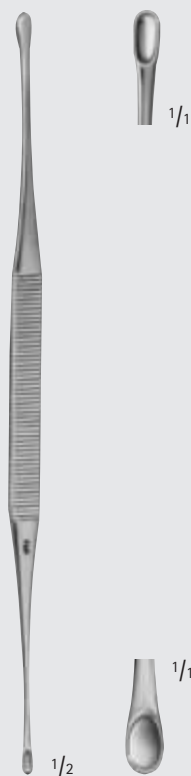

ASCH

**ER005R**

Sekretlöffel, stumpf

Secretion scoop, blunt

200 mm, 8"

## Urologie-Instrumente – Genito-Urinary Instruments

Urologie-Instrumente  
Genito-Urinary Instruments

EF

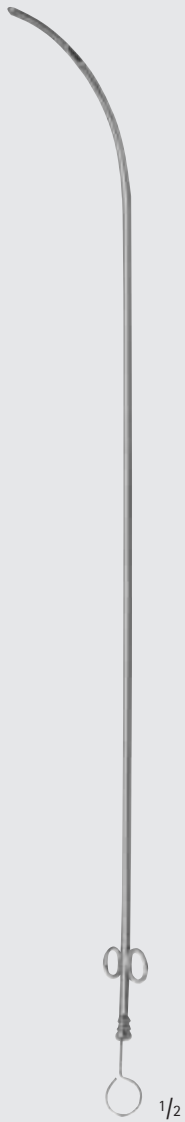

Charr. (French)

<b>EF208C</b>	8
<b>EF210C</b>	10
<b>EF212C</b>	12
<b>EF214C</b>	14
<b>EF216C</b>	16
<b>EF218C</b>	18
<b>EF220C</b>	20

Metallkatheter  
für Männer  
Male catheters,  
metal  
290 mm, 11 1/2"



Charr. (French)

<b>EF306C</b>	6
<b>EF308C</b>	8
<b>EF310C</b>	10
<b>EF312C</b>	12
<b>EF314C</b>	14
<b>EF316C</b>	16
<b>EF318C</b>	18

Metallkatheter  
für Frauen  
Female catheters  
metal  
155 mm, 6"

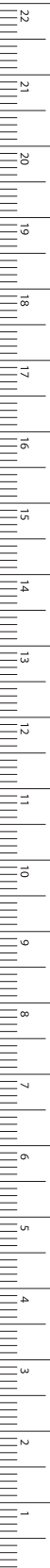

MILLIMETERS

## Urologie-Instrumente – Genito-Urinary Instruments

Urologie-Instrumente

Genito-Urinary Instruments

EF



**EF491C**

Katheterspanner und  
Einführungsinstrument  
Catheter guide  
(introducer)  
490 mm, 19 1/2"

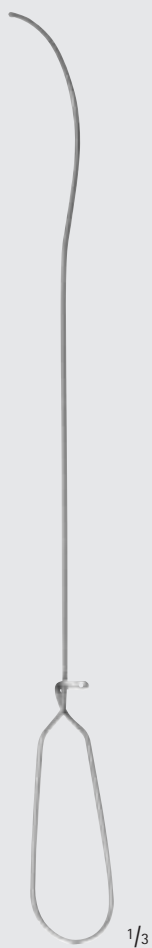

GUYON

**EF492R**

Katheterspanner und  
Einführungsinstrument  
Catheter guide  
(introducer)  
365 mm, 14 1/2"



**EF493R**

Kathetereinführungsinstrument  
Introducer for catheters  
460 mm, 18"



## Urologie-Instrumente – Genito-Urinary Instruments

Urologie-Instrumente  
Genito-Urinary Instruments

EF



1/2

Charr. (French)

EF638R	8
EF639R	9
EF640R	10
EF641R	11
EF642R	12
EF643R	13
EF644R	14
EF645R	15
EF646R	16
EF647R	17
EF648R	18
EF649R	19
EF650R	20
EF651R	21
EF652R	22
EF653R	23
EF654R	24
EF655R	25
EF656R	26
EF657R	27
EF658R	28
EF659R	29
EF660R	30

DITTEL

EF638R-EF660R

Metallbougie-Öffner, starr  
Urethral bougies  
and dilating sounds, stiff  
345 mm, 13 3/4"



1/2

TURNER WARWICK

EF790R

Harnröhrenbougie  
Retrograde bougie  
180 mm, 7"

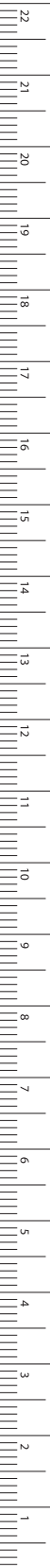

MILLIMETERS

## Urologie-Instrumente – Genito-Urinary Instruments

Urologie-Instrumente

Genito-Urinary Instruments

EF



<b>EF824R</b>	Ben.24/Charr.12
<b>EF826R</b>	Ben.26/Charr.13
<b>EF828R</b>	Ben.28/Charr.14
<b>EF830R</b>	Ben.30/Charr.15
<b>EF832R</b>	Ben.32/Charr.16
<b>EF834R</b>	Ben.34/Charr.17
<b>EF836R</b>	Ben.36/Charr.18
<b>EF838R</b>	Ben.38/Charr.19
<b>EF840R</b>	Ben.40/Charr.20
<b>EF842R</b>	Ben.42/Charr.21
<b>EF844R</b>	Ben.44/Charr.22
<b>EF846R</b>	Ben.46/Charr.23
<b>EF848R</b>	Ben.48/Charr.24
<b>EF850R</b>	Ben.50/Charr.25
<b>EF852R</b>	Ben.52/Charr.26
<b>EF854R</b>	Ben.54/Charr.27
<b>EF856R</b>	Ben.56/Charr.28
<b>EF858R</b>	Ben.58/Charr.29
<b>EF860R</b>	Ben.60/Charr.30

GUYON

**EF824R-EF860R**

Metallbougie-Öffner

Urethral bougies and  
dilating sounds

255 mm, 10"

## Urologie-Instrumente – Genito-Urinary Instruments

### Beschneidungsklemmen Circumcision Clamps

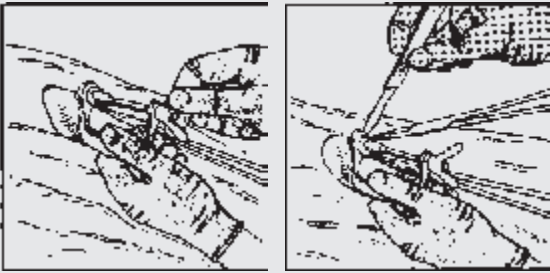

⌘ Der glockenförmige Stempel der Beschneidungsklemme wird über die Eichel geschoben und die Vorhaut darübergezogen, was 2 Klemmen oder Haltefäden erleichtern.

⌘ Die Flügelmutter wird so stark wie möglich angezogen, so dass die Vorhaut ringförmig maximal komprimiert wird.

⌘ Mit dem Skalpell wird die Vorhaut unmittelbar am Kompressionsring abgetragen. Zur Vermeidung von Blutungen bleibt die Beschneidungsklemme einige Minuten liegen. Es empfiehlt sich, größere Venen, in jedem Falle aber die Frenulararterie nach etwaiger Durchtrennung zu unterbinden.

⌘ Der Vorteil dieser Beschneidungsart liegt in der kosmetisch günstigen Narbe, wie sie nach Abstoßung des dünnen Nekrosesaumes entsteht.

⌘ Assisted by two hemostats or ligatures the foreskin is pushed over the bellshaped protection-rod and the glans is placed into it.

⌘ By now, the wing-nut is tightened as close as possible, so the foreskin is annular compressed. The foreskin is cut off with a scalpel, right next to the compression ring.

⌘ The circumcision clamp remains a few minutes to avoid bleeding. In case that any large vein, specially the frenular artery, is cut through, a ligature must be set.

⌘ The advantage of the method described is the cosmeticly favourable scar which is left after rejection of the small necrotized portion.

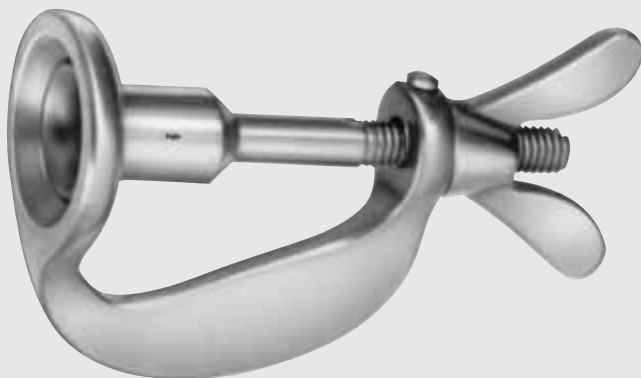

WINKELMANN

∅

diam.

**EF965R** 12 mm

**EF966R** 16 mm

**EF967R** 20 mm

Beschneidungsklemmen

Circumcision clamps



INCHES

EJ



Trokare  
Trocars

## Trokare – Trocars

Trokare

Trochars

EJ

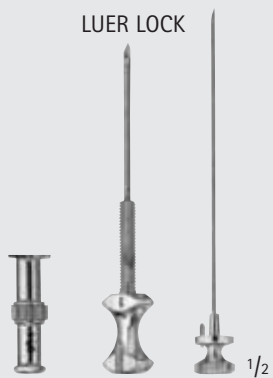

KLIMA-ROSEGGER

**SR428R**

Sternal-Punktionskanüle

Sternal puncture needle

1,8 x 35 mm

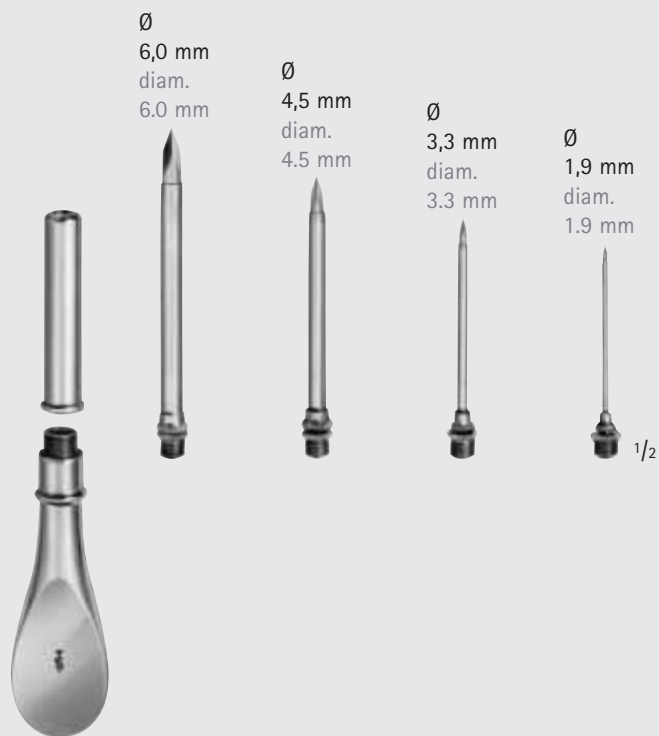

**EJ126R**

Universaltrokar mit 4  
Aufsätzen

Universal trocar with 4 tips



EL



**Scheidenspekula**  
Vaginal Specula

# Scheidenspekula – Vaginal Specula

Scheidenspekula  
Vaginal Specula

Scheidenspekula  
Schema für Maßangaben bei Spekula  
Vaginal specula  
How to measure vaginal specula

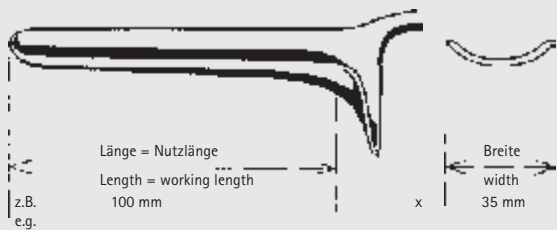

COLLIN

**ELO10C**

53 x 10 mm  
für Kinder  
for children

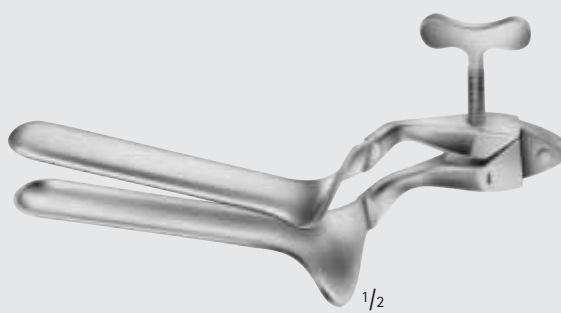

COLLIN

**ELO11R**

95/85 x 18 mm  
für Jungfrauen  
for virgins

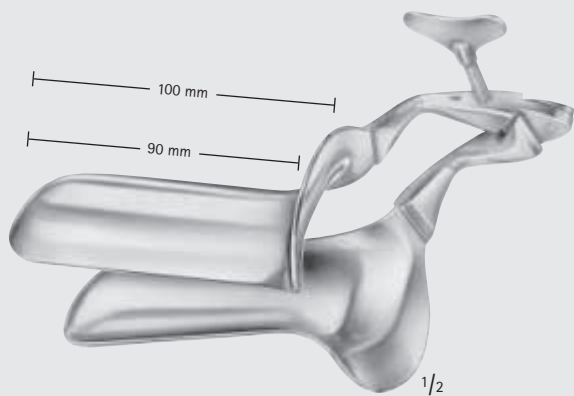

COLLIN

Gesamtlänge/Nutzlänge  
Total length/working length

Breite  
Width

	Gesamtlänge/Nutzlänge Total length/working length	Breite Width
<b>ELO13R</b>	100/90 mm	28 mm
<b>ELO14R</b>	100/90 mm	32 mm
<b>ELO15R</b>	105/95 mm	35 mm
<b>ELO16R</b>	115/105 mm	40 mm





## Scheidenspekula – Vaginal Specula

Scheidenspekula  
Vaginal Specula

73

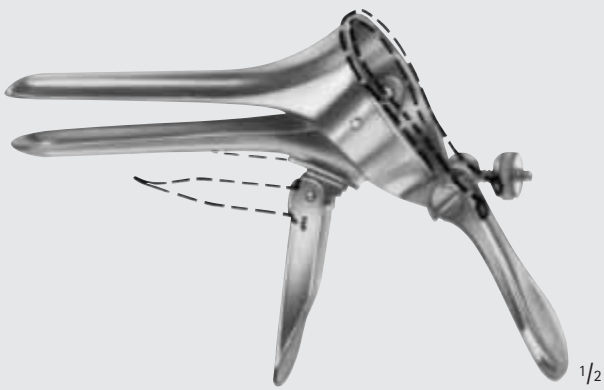

CUSCO

**ELO40R**

75 x 17 mm  
für Jungfrauen  
for virgins

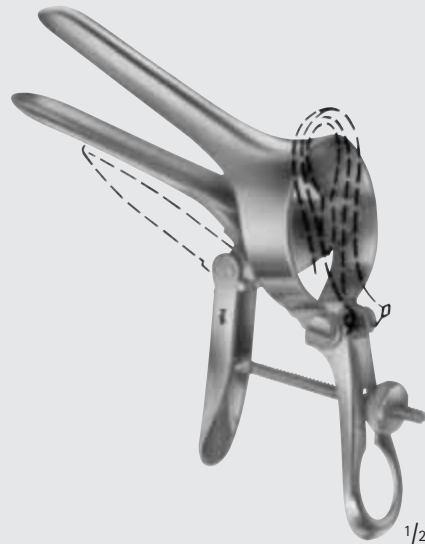

CUSCO

**EL075R**

75 x 17 mm  
für Jungfrauen  
for virgins



CUSCO

<b>EL056R</b>	92 x 23 - 25 mm
<b>EL057R</b>	100 x 25 - 27 mm
<b>EL058R</b>	110 x 27 - 30 mm

Schweizer Modelle  
speziell: lang und schmal  
Swiss patterns  
features: long and narrow

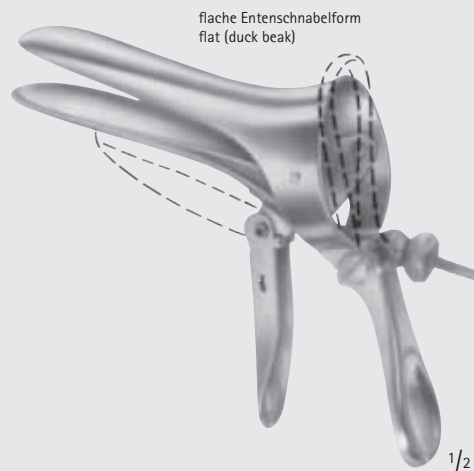

CUSCO

<b>EL086R</b>	80 x 32 mm
<b>EL087R</b>	90 x 37 mm
<b>EL088R</b>	115 x 37 mm



# Scheidenspekula – Vaginal Specula

Scheidenspekula

Vaginal Specula

Scheidenspekula

Schema für Maßangaben bei Spekula

Vaginal specula

How to measure vaginal specula

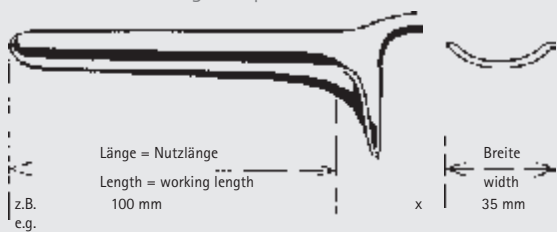

**CUSCO STANDARD**

<b>EL041R</b>	80 x 24 mm
<b>EL042R</b>	80 x 32 mm
<b>EL043R</b>	90 x 36 mm
<b>EL044R</b>	110 x 37 mm

Standard-Modelle  
Standard patterns

**CUSCO**

<b>EL076R</b>	80 x 24 mm
<b>EL077R</b>	80 x 32 mm
<b>EL078R</b>	90 x 36 mm
<b>EL079R</b>	110 x 37 mm

**CUSCO**

<b>EL080R</b>	107 x 29 mm
<b>EL081R</b>	115 x 35 mm

mit Absaugrohr  
with suction tube

**TRELAT**

<b>EL150R</b>	85 x 33 mm
<b>EL151R</b>	95 x 35 mm
<b>EL152R</b>	115 x 43 mm

EL





## Scheidenspekula – Vaginal Specula

Scheidenspekula  
Vaginal Specula

73

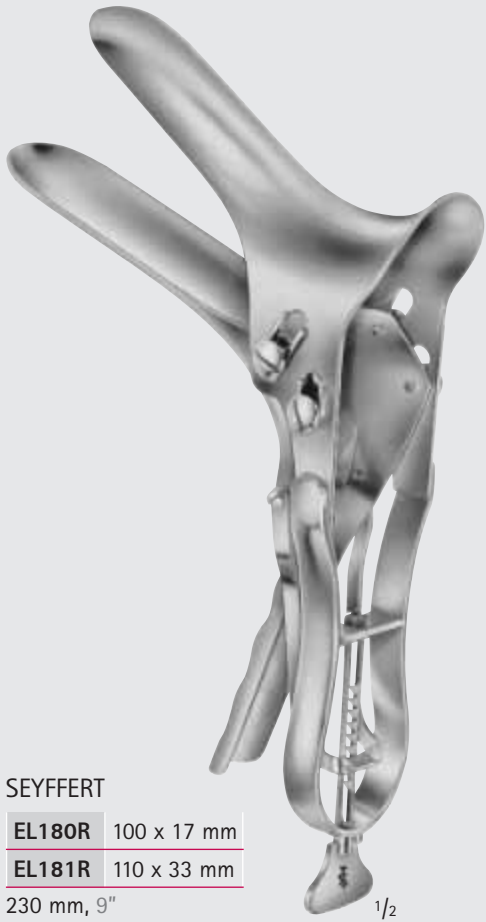

SEYFFERT

**EL180R** 100 x 17 mm

**EL181R** 110 x 33 mm

230 mm, 9"

1/2

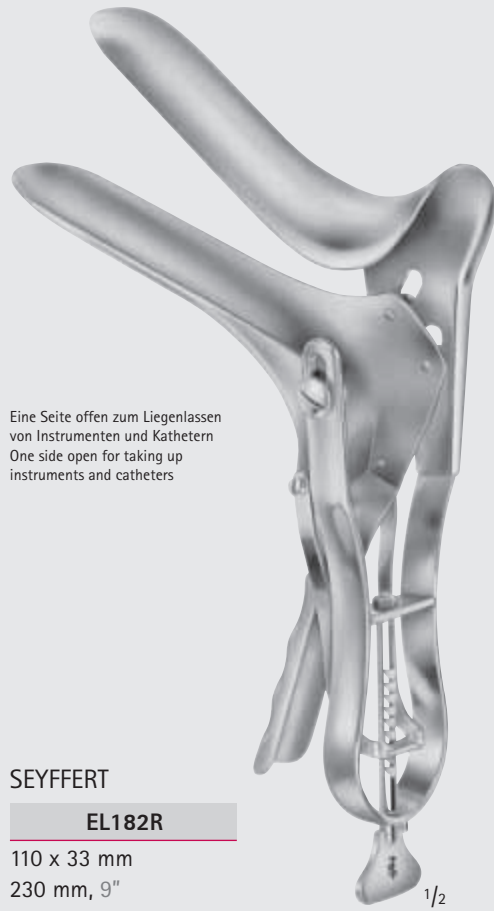

Eine Seite offen zum Liegenlassen  
von Instrumenten und Kathetern  
One side open for taking up  
instruments and catheters

SEYFFERT

**EL182R**

110 x 33 mm

230 mm, 9"

1/2



Mit Doppelsperre, Fixieren und Lösen  
der Sperre durch Daumendruck  
With double ratchet, closing and  
opening of ratchet by pressure of thumb

SEMM

**EL183R**

90 x 14 - 18 mm

für Kinder und Jungfrauen  
for children and virgins

180 mm, 7"

1/2



Mit Doppelsperre, Fixieren und Lösen  
der Sperre durch Daumendruck  
With double ratchet, closing and  
opening of ratchet by pressure of thumb

SEMM

**EL184R** 100 x 20 - 24 mm

**EL185R** 100 x 30 - 34 mm

185 mm, 7 1/4"

1/2

# Scheidenspekula – Vaginal Specula

Scheidenspekula  
Vaginal Specula

Scheidenspekula  
Schema für Maßangaben bei Spekula  
Vaginal specula  
How to measure vaginal specula

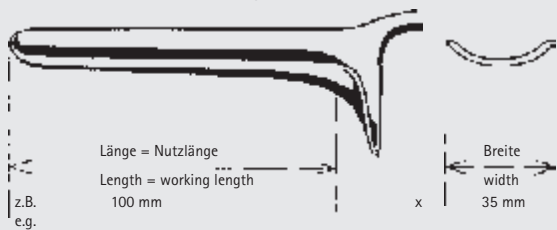

	Nutzlänge x Breite Working length x Width	Gesamtlänge Total length
SIMS		
EL407R	70 x 26 / 75 x 30 mm	125 mm, 5"
EL408R	75 x 30 / 80 x 35 mm	150 mm, 6"
EL409R	80 x 36 / 90 x 40 mm	175 mm, 7"

EL





## Scheidenspekula – Vaginal Specula

Scheidenspekula - Sätze, obere und untere Blätter

Vaginal Specula - Sets, Upper and Lower Blades

73

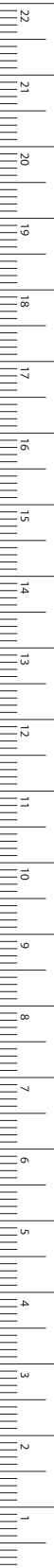

MILLIMETERS



### SEIDEL

**EL410R** 80 x 8 mm

**EL411R** 80 x 10 mm

**EL413R** 90 x 14 mm

für Kinder und Kleinkinder

for children and infants

170 mm, 6 3/4"

1/2



### KRISTELLER

**EL420R**

70 x 15 mm

für Kinder

for children

170 mm, 6 3/4"

1/2



### KRISTELLER

**EL421R** 70 x 27 mm

**EL422R** 75 x 30 mm

**EL423R** 90 x 36 mm

175 mm, 7"

1/2



### KRISTELLER

**EL424R** 110 x 18 mm

**EL426R** 110 x 20 mm

**EL425R** 110 x 27 mm

**EL427R** 110 x 30 mm

**EL428R** 110 x 36 mm

220 mm, 8 3/4"

1/2

# Scheidenspekula – Vaginal Specula

Scheidenspekula - untere Blätter

Vaginal Specula - Lower Blades

Scheidenspekula

Schema für Maßangaben bei Spekula

Vaginal specula

How to measure vaginal specula

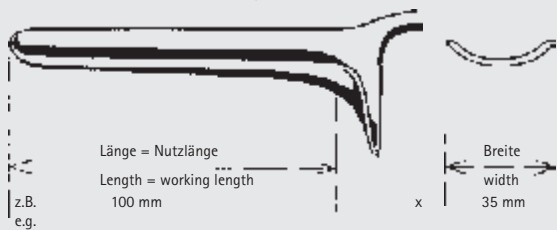

**EL440R**

70 x 15 mm

175 mm

7"



**EL441R**

70 x 27 mm

180 mm

7"



**EL442R**

75 x 30 mm

180 mm

7"



**EL443R**

90 x 36 mm

185 mm

7 1/4"

KRISTELLER

**EL440R-EL443R**

untere Blätter

lower blades

EL





## Scheidenspekula – Vaginal Specula

Scheidenspekula – obere Blätter

Vaginal Specula - Upper Blades

13

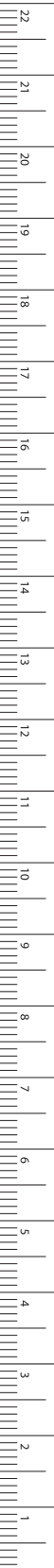

MILLIMETERS



KRISTELLER

**EL450R-EL453R**

obere Blätter  
upper blades



**EL450R**

75 x 10 mm

175 mm

7"



**EL451R**

75 x 23 mm

180 mm

7"



**EL452R**

80 x 25 mm

180 mm

7"



**EL453R**

100 x 32 mm

185 mm

7 1/4"

# Scheidenspekula – Vaginal Specula

Scheidenspekula - untere Blätter

Vaginal Specula - Lower Blades

Scheidenspekula

Schema für Maßangaben bei Spekula

Vaginal specula

How to measure vaginal specula

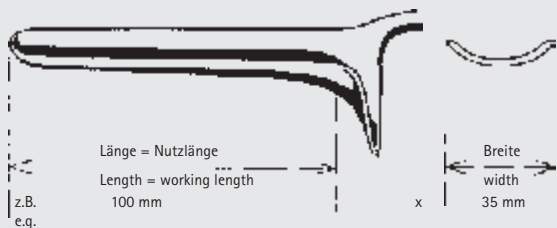

**EL444R**

110 x 18 mm

215 mm

8 1/2"

**EL445R**

110 x 27 mm

215 mm

8 1/2"

**EL446R**

110 x 20 mm

220 mm

8 3/4"

**EL447R**

110 x 30 mm

220 mm

8 3/4"

**EL448R**

110 x 36 mm

225 mm

9"

KRISTELLER

**EL444R-EL448R**

untere Blätter

lower blades

INCHES





## Scheidenspekula – Vaginal Specula

Scheidenspekula – obere Blätter

Vaginal Specula - Upper Blades

73



KRISTELLER

**EL454R-EL458R**

obere Blätter  
upper blades

**EL454R**

115 x 14 mm

215 mm

8 1/2"

**EL455R**

115 x 23 mm

215 mm

8 1/2"

**EL456R**

115 x 16 mm

220 mm

8 3/4"

**EL457R**

115 x 26 mm

220 mm

8 3/4"

**EL458R**

120 x 30 mm

225 mm

9"

MILLIMETERS

## Scheidenspekula – Vaginal Specula

Scheidenspekula

Vaginal Specula

Scheidenspekula

Schema für Maßangaben bei Spekula

Vaginal specula

How to measure vaginal specula

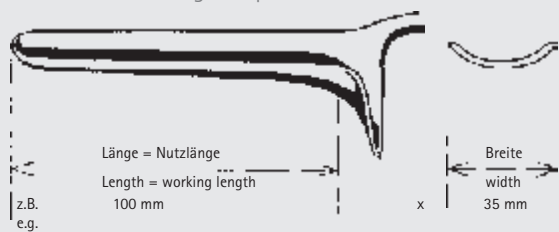

KALLMORGEN

**EL480R**

75 x 39 mm

Satz

Set

170 mm, 6 <sup>3</sup>/<sub>4</sub>"



KALLMORGEN

**EL481R**

95 x 39 mm

Satz

Set

200 mm, 8"



## Scheidenspekula – Vaginal Specula

Scheidenspekula  
Vaginal Specula

73



**EL494R**

110 x 20 mm



**EL495R**

110 x 30 mm



**EL496R**

110 x 36 mm



KRISTELLER

**EL494R-EL496R**

untere Blätter

lower blades

215 mm, 8 1/2"



**EL497R**

115 x 18 mm



**EL498R**

115 x 26 mm



KRISTELLER

**EL497R-EL499R**

obere Blätter

upper blades

220 mm, 8 3/4"

KRISTELLER

**EL491R** 110 x 20 mm

**EL492R** 110 x 30 mm

**EL493R** 110 x 36 mm

Wiener Modelle

Sätze

Vienna patterns

Sets

# Scheidenspekula – Vaginal Specula

## Scheidenspekula für Kinder und Jungfrauen

### Vaginal Specula for Children and Virgins

Scheidenspekula  
 Schema für Maßangaben bei Spekula  
 Vaginal specula  
 How to measure vaginal specula

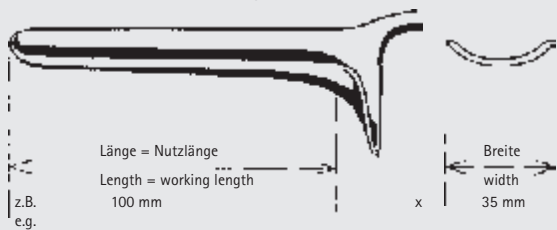

BRAUN

**EL550R**

56 x 13 mm  
 180 mm, 7"

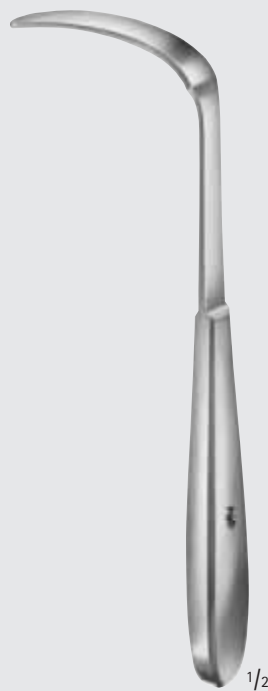

BRAUN

**EL551R**

60 x 10 mm  
 180 mm, 7"

EL





## Scheidenspekula – Vaginal Specula

Scheidenspekula für Kinder und Jungfrauen  
Vaginal Specula for Children and Virgins

EL



MATHIEU

**EL558R**

95 x 17 - 30 mm  
210 mm, 8 1/4"



MATHIEU

**EL559R**

95 x 17 - 26 mm  
passend zu EL558R  
fitting EL558R  
210 mm, 8 1/4"

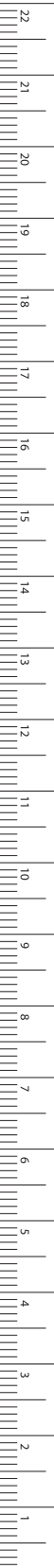

MILLIMETERS

# Scheidenspekula – Vaginal Specula

Scheidenspekula

Vaginal Specula

Scheidenspekula

Schema für Maßangaben bei Spekula

Vaginal specula

How to measure vaginal specula

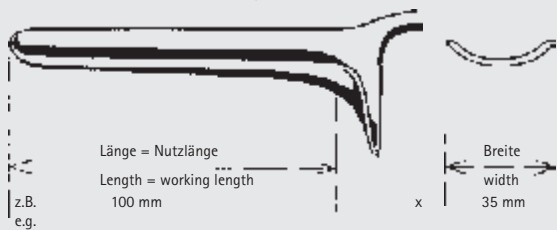

**EL578R**  
89 x 38 mm



**EL579R**  
102 x 38 mm

leicht hohl  
slightly concave



**JACKSON**  
**EL578R-EL579R**  
175 mm, 7"



**EL627R**  
60 x 45 mm



**EL628R**  
90 x 45 mm



**EL629R**  
112 x 45 mm



**DOYEN**  
**EL627R-EL629R**  
235 mm, 9 1/4"

EL





## Scheidenspekula – Vaginal Specula

Scheidenspekula  
Vaginal Specula

73



DOYEN

**EL631R-EL644R**

240 mm, 9 1/2"

	Länge Length	Breite Width
<b>EL631R</b>	60 mm	35 mm
<b>EL632R</b>	90 mm	35 mm
<b>EL633R</b>	120 mm	35 mm
<b>EL634R</b>	60 mm	45 mm
<b>EL635R</b>	90 mm	45 mm
<b>EL636R</b>	120 mm	45 mm
<b>EL637R</b>	60 mm	60 mm
<b>EL638R</b>	90 mm	60 mm
<b>EL639R</b>	120 mm	60 mm
<b>EL642R</b>	160 mm	45 mm
<b>EL644R</b>	160 mm	60 mm



LANDON

**EL660R**

89 x 25 mm  
195 mm, 7 3/4"



MILLIMETERS

## Scheidenspekula – Vaginal Specula

Scheidenspekula

Vaginal Specula

Scheidenspekula

Schema für Maßangaben bei Spekula

Vaginal specula

How to measure vaginal specula

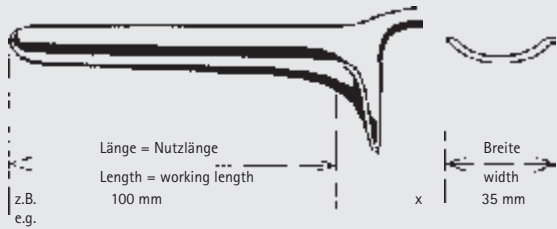

EASTMAN

**EL581R**

89 x 38 mm  
175 mm, 7"



HEANEY

**EL865R**

83 x 29 mm  
170 mm, 6 3/4"

EL







## Scheidenspekula – Vaginal Specula

Scheidenspekula  
Vaginal Specula

73



LANDAU

**EL690R** 100 x 28 mm

**EL691R** 110 x 38 mm

290 mm, 11 1/2"



BREISKY

**EL703R** 100 x 20 mm

**EL704R** 100 x 25 mm

**EL705R** 100 x 30 mm

**EL707R** 100 x 35 mm

**EL708R** 100 x 40 mm

Wiener Modelle

Vienna patterns

300 mm, 12"



BREISKY

**EL693R** 130 x 20 mm

**EL694R** 130 x 25 mm

**EL695R** 130 x 30 mm

**EL697R** 130 x 35 mm

**EL698R** 130 x 40 mm

Wiener Modelle

Vienna patterns

320 mm, 12 3/4"



BREISKY

**EL700R** 160 x 40 mm

**EL702R** 180 x 40 mm

Wiener Modelle

Vienna patterns

350 mm, 14"

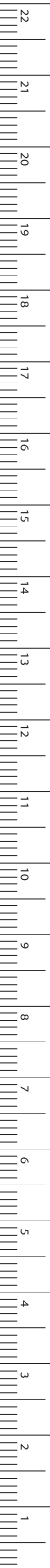

MILLIMETERS

## Scheidenspekula – Vaginal Specula

Scheidenhalter und Wundhaken

Vaginal- and Wound Retractors

Scheidenspekula

Schema für Maßangaben bei Spekula

Vaginal specula

How to measure vaginal specula

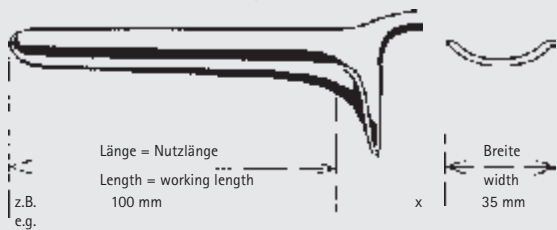

WEISSBARTH

**EL720C** 80 x 28 mm

**EL721C** 85 x 42 mm

210 mm, 8 1/4 "

**EL722C**

abnehmbares Auffangsieb  
allein  
removable strainer only



DOYEN

**EL859R**

60 x 30 mm  
seitliches Spekulum  
lateral speculum

1/2 230 mm, 9"



DOYEN

**EL860R**

80 x 30 mm  
seitliches Spekulum  
lateral speculum

1/2 250 mm, 10"

EL





## Scheidenspekula – Vaginal Specula

Scheidenhalter und Wundhaken  
Vaginal- and Wound Retractors

73

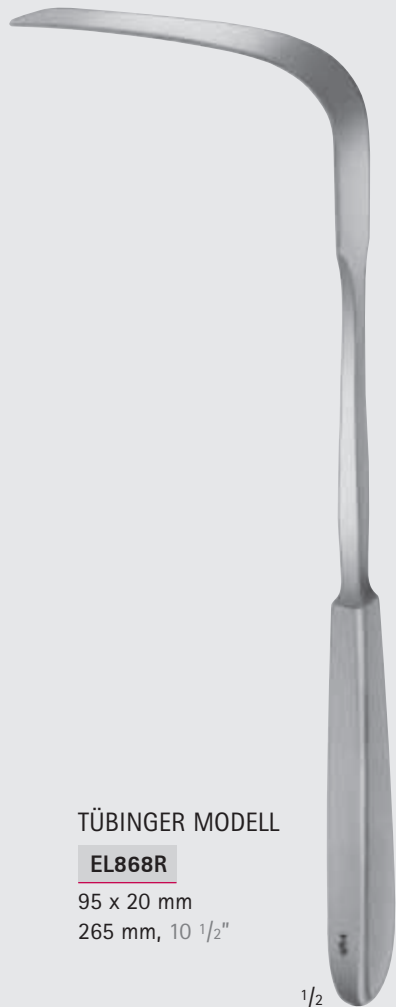

TÜBINGER MODELL

**EL868R**

95 x 20 mm  
265 mm, 10 1/2"

1/2

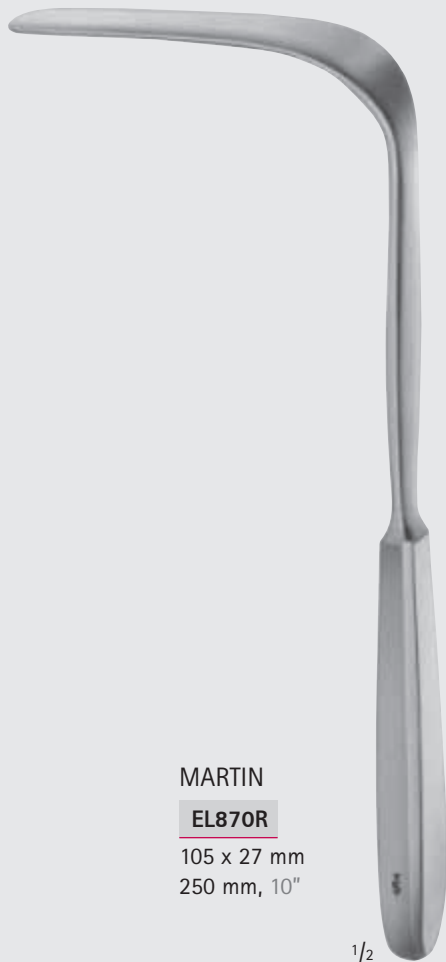

MARTIN

**EL870R**

105 x 27 mm  
250 mm, 10"

1/2



SIMON

**EL872R**

115 x 22 mm  
275 mm, 10 3/4"

1/2



SIMON

**EL873R**

115 x 26 mm  
275 mm, 10 3/4" 1/2



MILLIMETERS

## Scheidenspekula – Vaginal Specula

Scheidenspekula

Vaginal Specula

Scheidenspekula

Schema für Maßangaben bei Spekula

Vaginal specula

How to measure vaginal specula

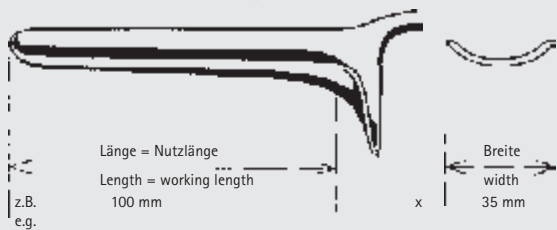

AUVARD

**EL736R**

65 x 38 - 28 mm

1,530 kg = 3 lbs. 6 oz.  
mit abnehmbarem Gewicht

1.530 kg = 3 lbs. 6 oz.  
with detachable weight  
230 mm, 9"



AUVARD

**EL738R** 75 x 42 - 40 mm

**EL739R** 105 x 43 - 40 mm

1,470 kg = 3 lbs. 4 oz.  
mit abnehmbarem Gewicht

1.470 kg = 3 lbs. 4 oz.  
with detachable weight  
230 mm, 9"



## Scheidenspekula – Vaginal Specula

Scheidenspekula  
Vaginal Specula

73

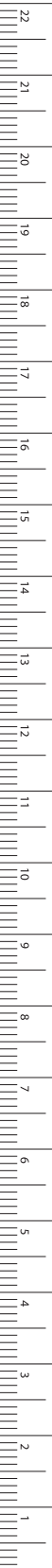

**EL741R**

80 x 30 mm



**EL744R**

55 x 40 - 60 mm

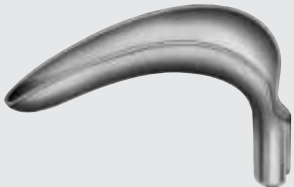

**EL742R**

85 x 35 mm



**EL743R**

85 x 40 mm

**EL745R**

70 x 45 - 70 mm

**EL748R**



**EL746R**

**EL747R**

1/3

Die Blätter sind austauschbar.  
Sie passen sowohl auf den Griff EL746R,  
als auch auf die Griffe EL759R und EL760R,  
siehe Seite 658

The blades can be exchanged.  
They fit handle EL746R as well as  
handles EL759R and EL760R,  
see page 658

### SCHERBACK

**EL740R**

Satz, bestehend aus:

Griff (EL746R)

Gewicht (EL747R)

4 Blätter (EL741R - EL744R)

Set, consisting of:

Handle (EL746R)

Weight (EL747R)

4 Blades (EL741R - EL744R)

MILLIMETERS

# Scheidenspekula – Vaginal Specula

Scheidenspekula

Vaginal Specula

Scheidenspekula

Schema für Maßangaben bei Spekula

Vaginal specula

How to measure vaginal specula

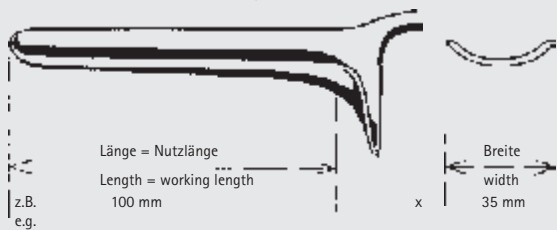

**EL755R**

80 x 30 mm



**EL751R**

65 x 30 mm



**EL756R**

85 x 33 mm



**EL752R**

75 x 35 mm



**EL757R**

100 x 38 mm



**EL753R**

85 x 35 mm



**EL758R**

110 x 42 mm



**EL754R**

95 x 35 mm



$\frac{1}{3}$

**EL759R**

230 mm, 9"



$\frac{1}{3}$

**EL760R**

220 mm, 8  $\frac{3}{4}$ "

Die Blätter sind austauschbar.

Sie passen sowohl auf den Griff EL746R,  
als auch auf die Griffe EL759R und EL760R

The blades can be exchanged.

They fit handle EL746R as well as  
handles EL759R and EL760R



**Scheidenspekula – Vaginal Specula**  
Vulva-Spreizer  
Vaginal Retractor

73



JOLL (FRIEDMANN)

**BV087R**

155 mm, 6"



GELPI

**BV996R**

135 mm, 5 1/4"

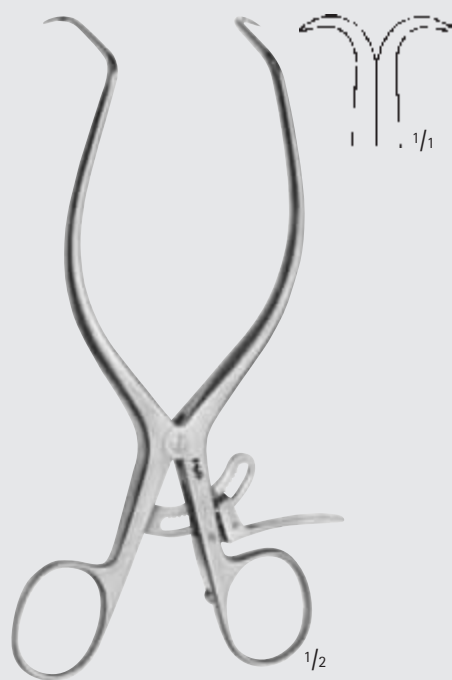

GELPI

**BV997R**

175 mm, 7"

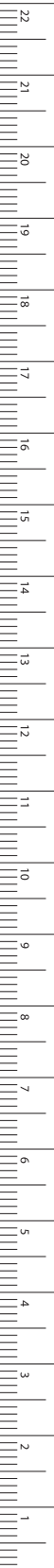

MILLIMETERS



INCHES



EM



Uterus-Dilatatoren  
Uterine Dilators

## Uterus-Dilatatoren – Uterine Dilators

Uterus-Dilatatoren

Uterine Dilators

EM



1/2

EM101R	1 mm	EM114R	14 mm	EM131R	1 1/2 mm	EM144R	14 1/2 mm
EM102R	2 mm	EM115R	15 mm	EM132R	2 1/2 mm	EM145R	15 1/2 mm
EM103R	3 mm	EM116R	16 mm	EM133R	3 1/2 mm	EM146R	16 1/2 mm
EM104R	4 mm	EM117R	17 mm	EM134R	4 1/2 mm	EM147R	17 1/2 mm
EM105R	5 mm	EM118R	18 mm	EM135R	5 1/2 mm		
EM106R	6 mm	EM119R	19 mm	EM136R	6 1/2 mm		
EM107R	7 mm	EM120R	20 mm	EM137R	7 1/2 mm		
EM108R	8 mm	EM121R	21 mm	EM138R	8 1/2 mm		
EM109R	9 mm	EM122R	22 mm	EM139R	9 1/2 mm		
EM110R	10 mm	EM123R	23 mm	EM140R	10 1/2 mm		
EM111R	11 mm	EM124R	24 mm	EM141R	11 1/2 mm		
EM112R	12 mm	EM125R	25 mm	EM142R	12 1/2 mm		
EM113R	13 mm	EM126R	26 mm	EM143R	13 1/2 mm		

HEGAR

EM101R-EM147R

mit stark konischer Spitze

with very conical point

185 mm, 7 1/4"



1/2

EM231R	1 + 2 mm
EM232R	3 + 4 mm
EM233R	5 + 6 mm
EM234R	7 + 8 mm
EM235R	9 + 10 mm
EM236R	11 + 12 mm
EM237R	13 + 14 mm
EM238R	15 + 16 mm
EM239R	17 + 18 mm

HEGAR

EM231R-EM239R

195 mm, 7 3/4"



## Uterus-Dilatatoren – Uterine Dilators

Uterus-Dilatatoren  
Uterine Dilators

EM

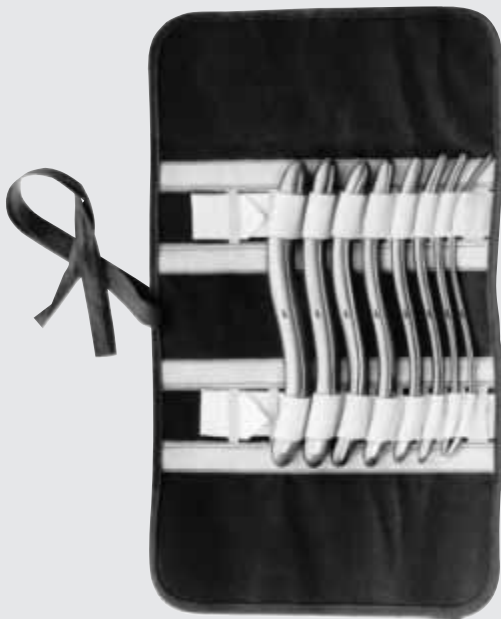

HEGAR

**EM244R**

Uterus-Dilatatoren,  
in Segeltuchtasche (EM245),  
mit 8 Dilatoren (EM232R-EM239R)

Uterine dilator set,  
in canvas roll (EM245),  
with 8 dilators (EM232R-EM239R)



**EM271R** 13 - 15 Char.

**EM272R** 17 - 19 Char.

**EM273R** 21 - 23 Char.

**EM274R** 25 - 27 Char.

**EM275R** 29 - 31 Char.

**EM276R** 33 - 35 Char.

**EM277R** 37 - 39 Char.

**EM278R** 41 - 43 Char.

PRATT

**EM271R-EM278R**

290 mm, 11 1/2"



MILLIMETERS

## Uterus-Dilatatoren – Uterine Dilators

Uterus-Dilatatoren – komplette Sätze

Uterine Dilators – Complete Sets



HEGAR

**EM193R**

Dilatatoren-Satz,  
bestehend aus:

EM104R-EM117R	14 Dilatatoren
EM097R	1 Lagerungssieb für Dilatatoren 4-12 mm
EM098R	1 dto. für Dilatatoren 13-17 mm
JG161R	1 Metalletui allein, mit Scharnierdeckel, 200 x 100 x 35 mm, nichtrostend

Dilator set,  
consisting of:

EM104R-EM117R	14 Dilators
EM097R	1 Rack for dilators 4-12 mm
EM098R	1 Rack for dilators 13-17 mm
JG161R	1 Metal case only, with hinged lid, 200 x 100 x 35 mm, stainless,



HEGAR

**EM194R**

Dilatatoren-Satz,  
bestehend aus:

EM101R-EM126R	26 Dilatatoren
EM099R	1 Lagerungssieb für Dilatatoren 1-17 mm
EM100R	1 dto. für Dilatatoren 18-26 mm
JG170R	1 Metalletui allein, mit Alu-Scharnierdeckel, 330 x 220 x 80 mm

Dilator set,  
consisting of:

EM101R-EM126R	26 Dilators
EM099R	1 Rack for dilators 1-17 mm
EM100R	1 Rack for dilators 18-26 mm
JG170R	1 Metal case only, with hinged lid of aluminium, 330 x 220 x 80 mm



## Uterus-Dilatatoren – Uterine Dilators

### Sterilgutlagertechnik für Dilatatoren

### Suggestions for Sterile Storage of Dilators



Weitere Informationen finden Sie in unserem Prospekt C404.  
For further details see brochure No. C404.

#### Gleitschieber-Halterung

zur übersichtlichen und zweckmäßigen Lagerung von Dilatatoren, Bougies, Kathetern und dergleichen.

Schiene und Anschlagrahmen können beliebig in den Siebkörben oder auf den Siebböden angeordnet werden. Die Gleitschieber sind auf der Schiene verschiebbar und werden durch einen Federmechanismus arretiert. Auf Wunsch können die Gleitschieber mit Kennzeichnungen versehen werden.

#### Sliding rail

with adjustable dividers for clear and suitable storage of dilators, bougies, catheters and suchlike.

Sliding rail as well as limiting bar can be optionally arranged in the wire baskets or on the wire bases. On the rail the dividers are slidable and are fixed by a spring mechanism. On demand, the dividers can be marked with identifications.

#### Pack- und Lagerungsbeispiele

Examples for arranging and storing

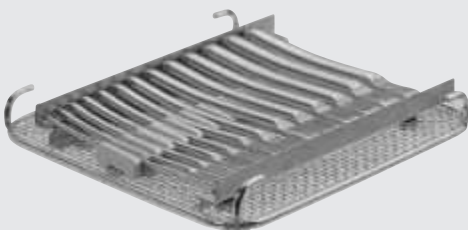

#### JF910R-JF908R

Uterus-Dilatatoren (ca. 12-16 Stück)

- JF910R 1 Siebboden oder
- JF489R 1 Siebkorb
- JF906R 1 Schiene
- JF905 15 Gleitschieber
- JF908R 2 Anschlagrahmen

Uterine dilators (approx. 12-16 pieces)

- JF910R 1 wire base or
- JF489R 1 wire basket
- JF906R 1 sliding rail
- JF905 15 dividers
- JF908R 2 limiting bars

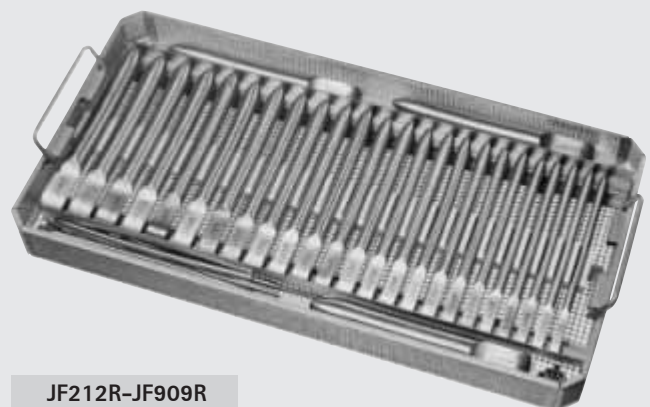

#### JF212R-JF909R

Uterus-Dilatatoren (ca. 26-30 Stück)

- JF212R 1 Siebkorb oder
- JF915R 1 Siebboden
- JF907R 1 Schiene
- JF905 31 Gleitschieber
- JF909R 2 Anschlagrahmen

Uterine dilators (approx. 26-30 pieces)

- JF212R 1 wire basket or
- JF915R 1 wire base
- JF907R 1 sliding rail
- JF905 31 dividers
- JF909R 2 limiting bars

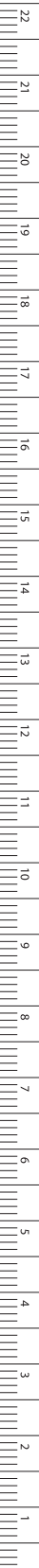

## Uterus-Dilatatoren – Uterine Dilators

Steritgutlagertechnik für Dilatatoren

Suggestions for Sterile Storage of Dilators

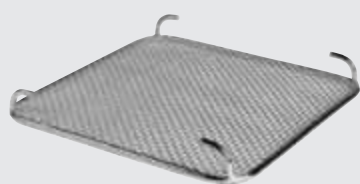

**JF910R**

Siebboden  
mit Griffen zum herausheben  
Wire base  
with handle hooks to lift out  
258 x 258 x 32 mm

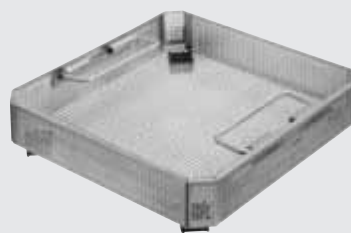

**JF112R**

Siebkorb  
Griffbeweglichkeit 90°,  
senkrecht - waagrecht  
Wire basket  
handles can be moved up to 90° angle,  
vertical - horizontal  
257 x 245 x 50 mm

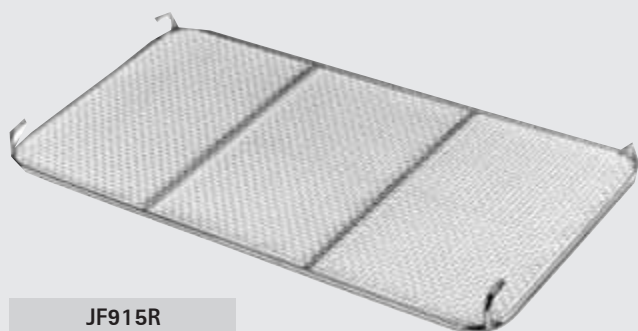

**JF915R**

Siebboden  
mit Griffen zum herausheben  
Wire base  
with handle hooks to lift out  
544 x 257 x 32 mm

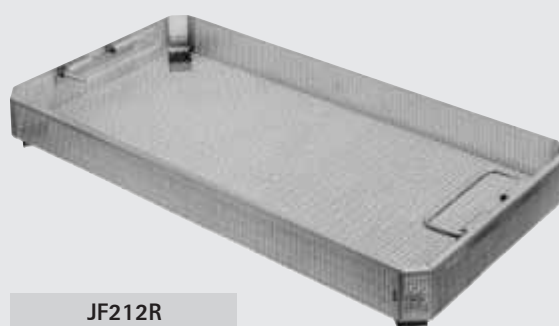

**JF212R**

Siebkorb  
Griffbeweglichkeit 90°,  
senkrecht - waagrecht  
Wire basket  
handles can be moved up to 90° angle,  
vertical - horizontal  
485 x 257 x 50 mm



**JF905**

Gleitschieber  
auf den Schienen JF906R und  
JF907R individuell verschiebbar  
Divider  
to be used on sliding rails  
JF906R and JF907R



Länge  
Length

<b>JF906R</b>	232 mm
<b>JF907R</b>	471 mm

Schiene DBGM  
für Gleitschieber JF905,  
mit Befestigungsschrauben  
Sliding rails DBGM  
with securing screws,  
for divider JF905



Länge  
Length

<b>JF908R</b>	232 mm
<b>JF909R</b>	471 mm

Anschlagrahmen DBGM  
speziell zur Lagerung von Dilatatoren,  
mit Befestigungsschrauben  
Limiting bars DBGM  
with securing screws,  
particularly useful for storing dilators



## Uterus-Dilatatoren – Uterine Dilators

Endospekula für Cervix und Harnröhre  
Endospecula for Cervix and Urethra

EM



KOGAN

**EM710R**

ohne Sperre  
without ratchet  
240 mm, 9 1/2"

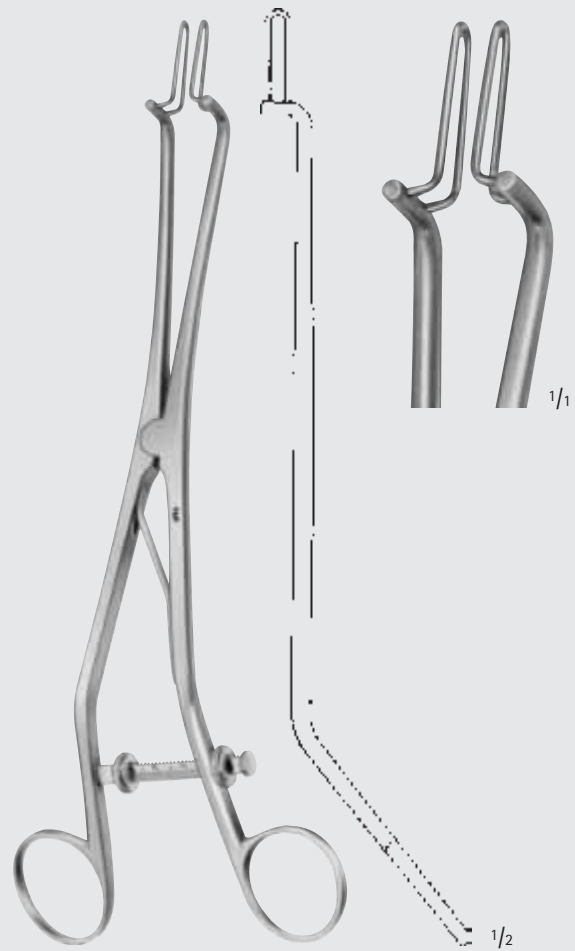

KOGAN

**EM711R**

mit Skalensperre und  
Fixierschraube  
with scale-ratchet and  
fixing screw  
240 mm, 9 1/2"

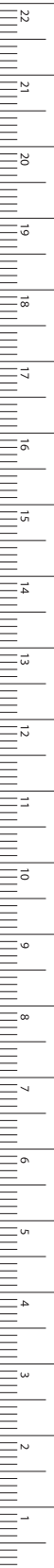



INCHES



EO



**Uterussonden, Tampon-, Haken-,  
Uterusfasszangen**  
Uterine Probes, Uterine Dressing-,  
Tenaculum and Uterine Elevating Forceps

## Uterussonden – Uterine Probes

Uterussonden

Uterine Probes

EO



Knopf-Ø 5 mm  
Diam. of tip



1/2

MAYO

**EO005R**

biegsam  
malleable  
330 mm, 13 1/8"

Knopf-Ø 4 mm  
Diam. of tip

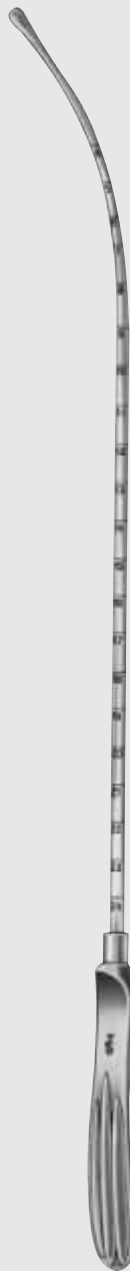

1/2

SIMS

**EO010R**

330 mm, 13"

**EO012R**

biegsam  
malleable  
330 mm, 13"

Knopf-Ø 3,6 mm  
Diam. of tip



1/2

GALABINS

**EO013R**

Schaft graduiert in cm,  
biegsam

Schaft graduated in cm,  
malleable  
295 mm, 11 3/4"

Knopf-Ø 3 mm  
Diam. of tip

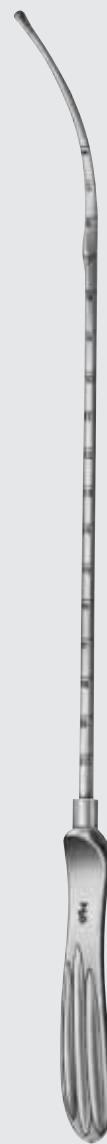

1/2

MARTIN

**EO015R**

300 mm, 12"



**Uterussonden – Uterine Probes**  
 Uterussonden, Uterus-Depressor  
 Uterine Probes, Uterine Depressor

**EO**



MILLIMETERS

Knopf-Ø 4 mm  
 Diam. of tip



1/2

**VALLEIX**

**EO016R**

graduiert,  
 mit Schieber  
 graduated,  
 with slider  
 250 mm, 10"

Knopf-Ø 4 mm  
 Diam. of tip



1/2

**SIMPSON**

**EO020**

biegsam,  
 versilbert  
 malleable,  
 silver-plated  
 310 mm, 12 1/4"



24 mm

28 mm

1/2

**BRAUN**

**EO030R**

Uterus-Depressor  
 Uterine depressor  
 270 mm, 10 3/4"

## Uterussonden – Uterine Probes

Tamponzangen

Uterine Dressing Forceps

EO



**EO060R**  
gerade  
straight

**EO061R**  
gebogen  
curved

PELKMANN

**EO060R-EO061R**

260 mm, 10 1/4"

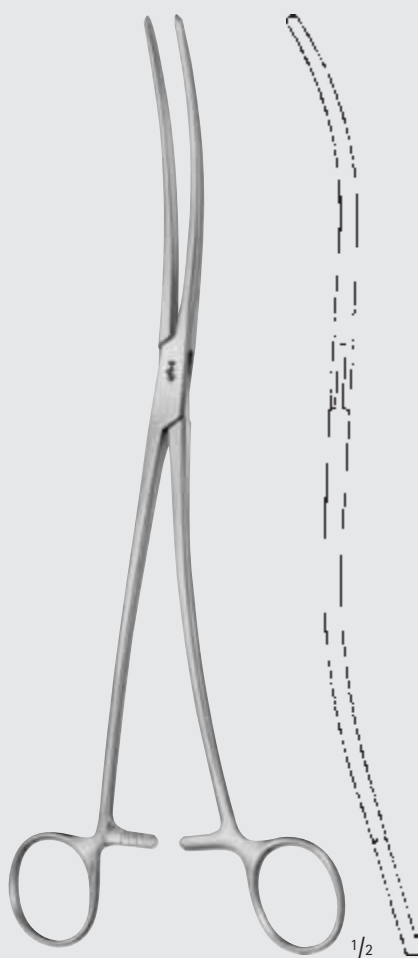

BOZEMANN

**EO075R**

250 mm, 10"

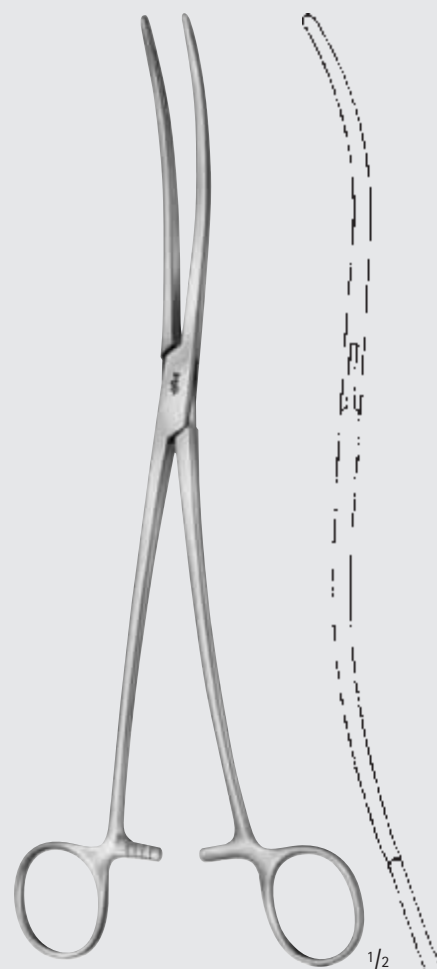

BOZEMANN

**EO077R**

Maul mit Längskehle  
Jaws with longitudinal groove  
255 mm, 10"



**Uterussonden – Uterine Probes**  
Tamponzangen  
Uterine Dressing Forceps

EO

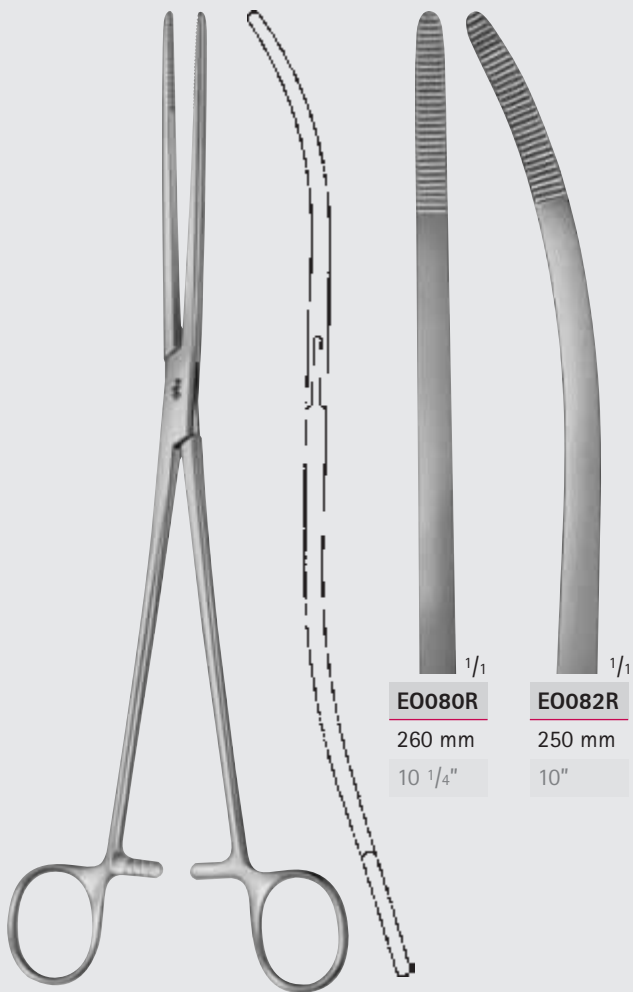

**EO080R**

260 mm

10 1/4"

1/1

**EO082R**

250 mm

10"

1/1

BOZEMANN

**EO080R-EO082R**



1/1

1/2

BOZEMANN-DOUGLAS

**EO085R**

260 mm, 10 1/4"

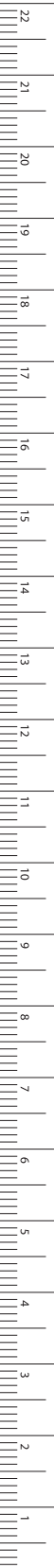

MILLIMETERS

## Uterussonden – Uterine Probes

Hakenzangen

Uterine Tenaculum Forceps

EO

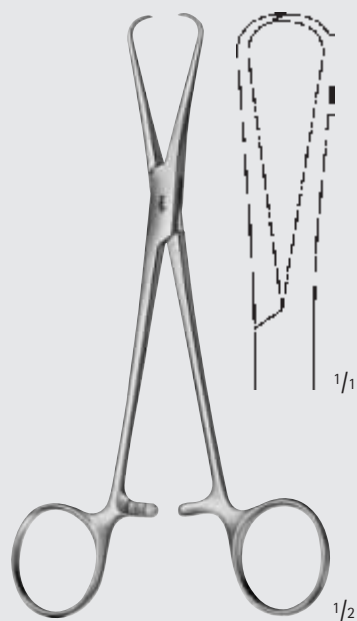

BERNHARD

**BF426R**

160 mm, 6 1/4"



POZZI

**EO105R**

175 mm, 7"



ADAIR

**EO106R**

190 mm, 7 1/2"



**Uterussonden – Uterine Probes**  
Hakenzangen  
Uterine Tenaculum Forceps

**EO**

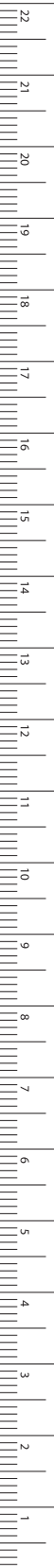

MILLIMETERS



**BRAUN**

**EO108R**

feines Modell  
slender pattern  
250 mm, 10"



**COLLIN-POZZI**

**EO122R**

250 mm, 10"



**SCHRÖDER**

**EO110R**

Standard Modell  
Standard pattern  
250 mm, 10"

## Uterussonden – Uterine Probes

Hakenzangen

Uterine Tenaculum Forceps

EO



SCHRÖDER

EO111R

250 mm, 10"



WILSON

EO112R

240 mm, 9 1/2"



POZZI

EO125R

kräftiges Modell  
heavy pattern  
255 mm, 10"





**Uterussonden – Uterine Probes**  
Hakenzangen  
Uterine Tenaculum Forceps

**EO**



MARTIN

**EO115R**

265 mm, 10 1/2"

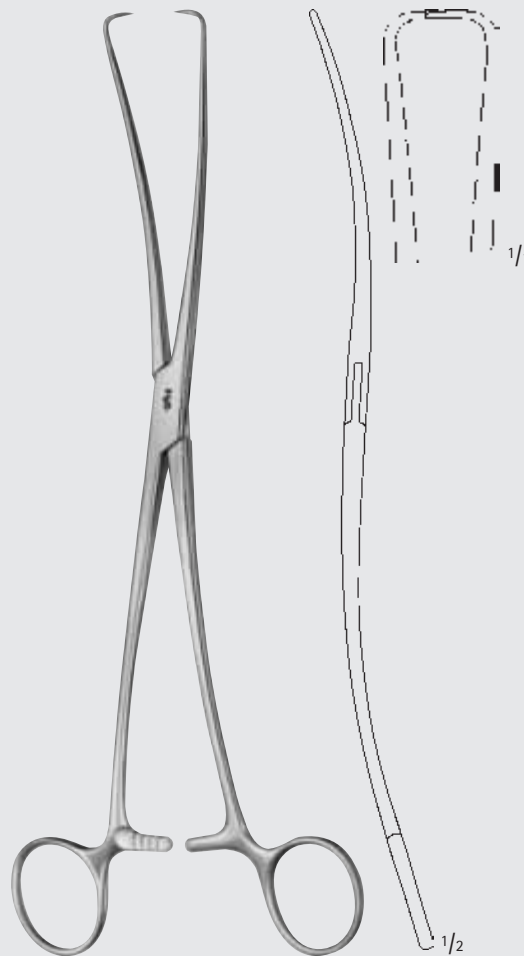

DUPLAY

**EO130R**

250 mm, 10"

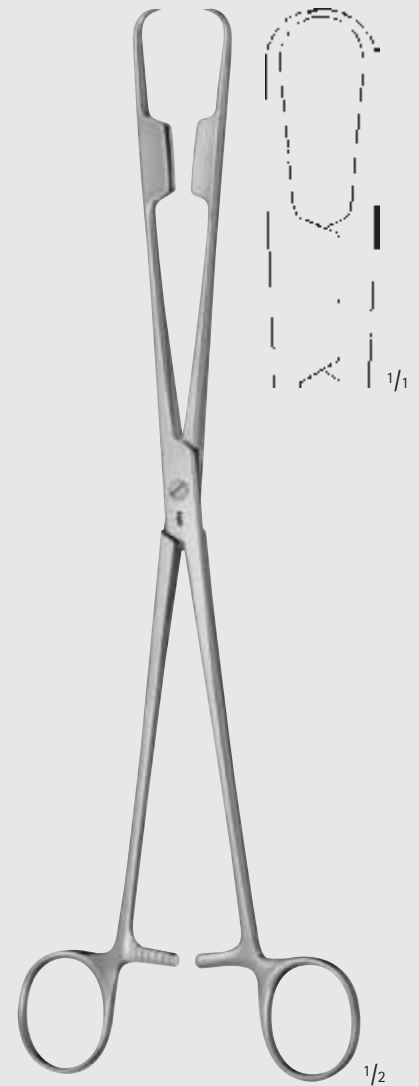

ABEL

**EO140R**

280 mm, 11"

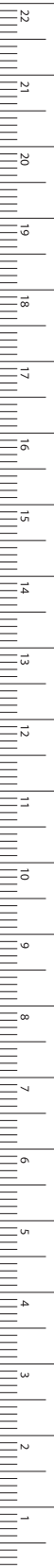

MILLIMETERS

# Uterussonden – Uterine Probes

## Hakenzangen

### Uterine Tenaculum Forceps

EO

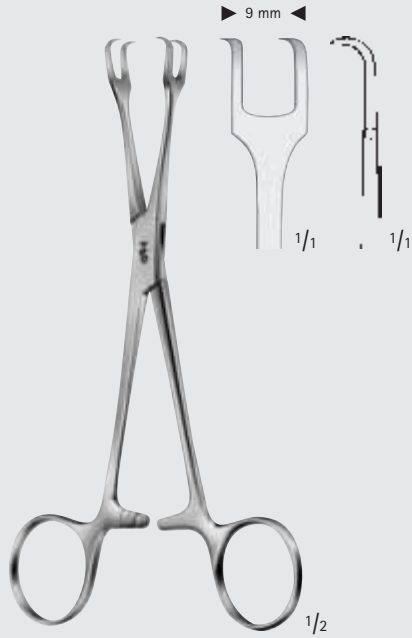

LAHEY

**BF309R**

155 mm, 6"

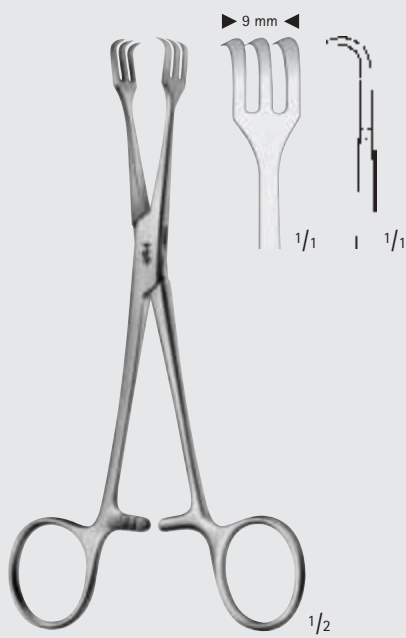

LAHEY

**BF310R**

155 mm, 6"

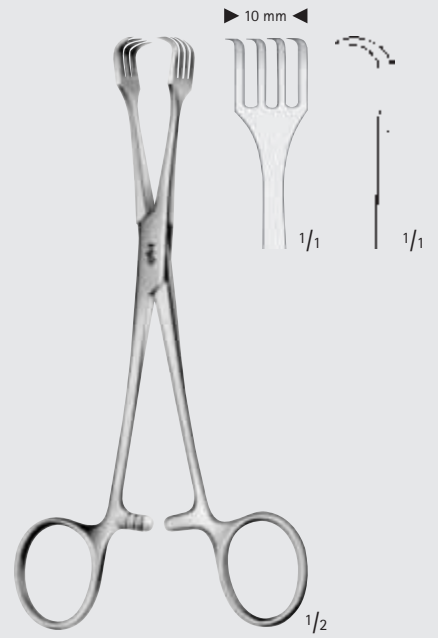

BRAUN

**BF311R**

155 mm, 6"

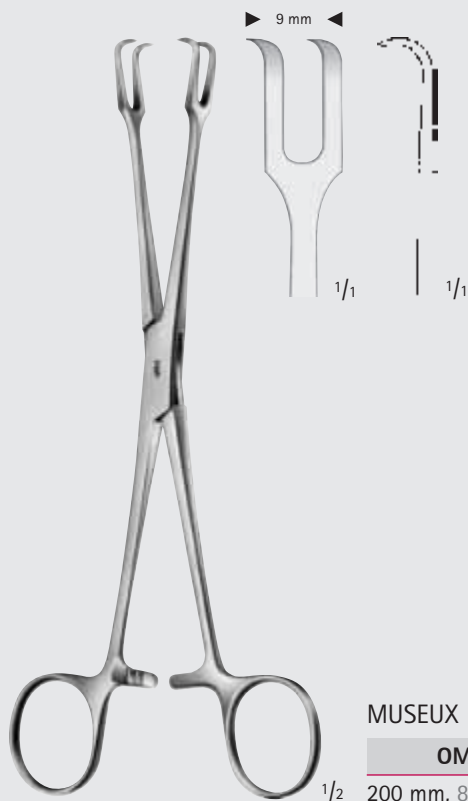

MUSEUX

**OM602R**

200 mm, 8"

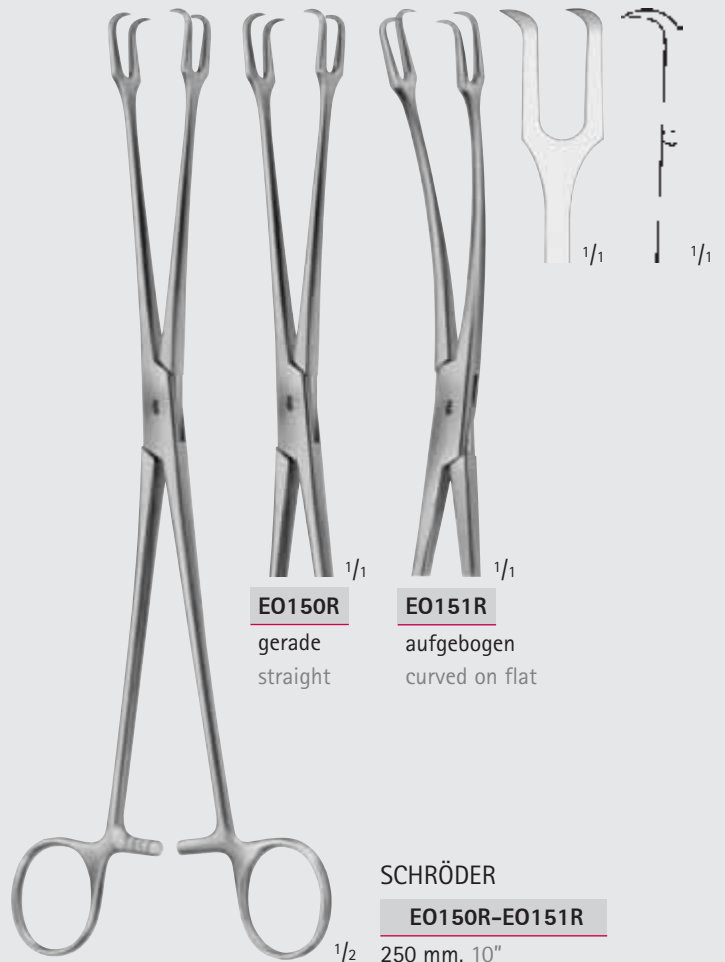

**EO150R**

gerade  
straight

**EO151R**

aufgebogen  
curved on flat

SCHRÖDER

**EO150R-EO151R**

250 mm, 10"



**Uterussonden – Uterine Probes**  
Hakenzangen  
Uterine Tenaculum Forceps

EO



MILLIMETERS



CZERNY

**EO164R**

200 mm, 8"



SCHRÖDER

**EO163R**

270 mm, 10 3/4"

## Uterussonden – Uterine Probes

Hakenzangen

Uterine Tenaculum Forceps

EO



AESCULAP-PRATT

EO165R

260 mm, 10 1/4"

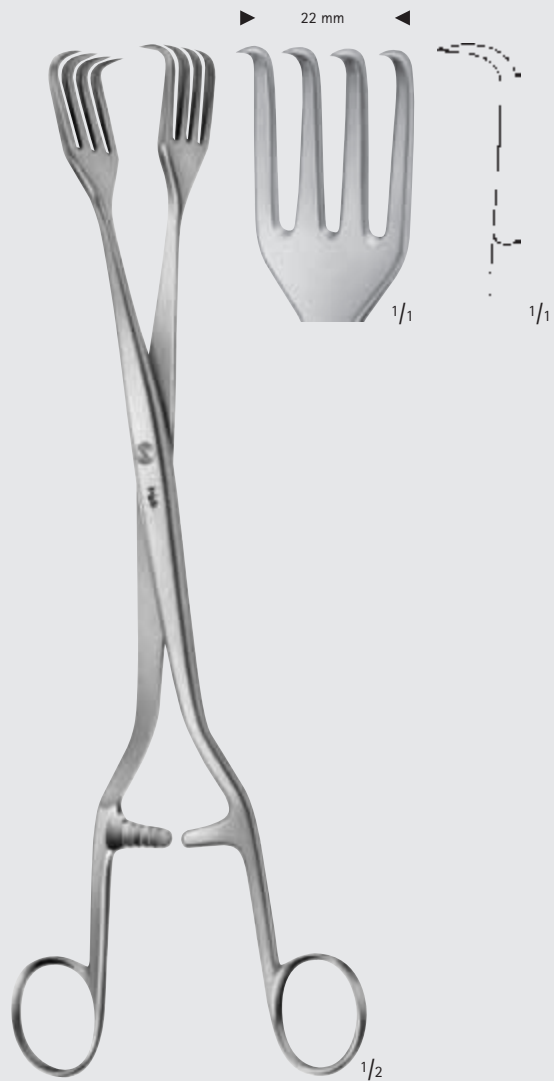

PRATT

EO166R

270 mm, 10 3/4"



**Uterussonden – Uterine Probes**  
Hakenzangen  
Uterine Tenaculum Forceps

**EO**

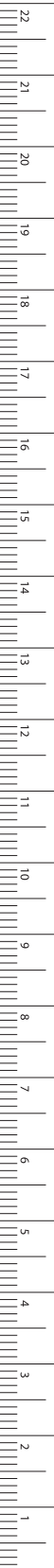

MILLIMETERS



KÜSTNER

**E0171R**

250 mm, 10"



TEALE

**E0177R**

180 mm, 7"

**Uterussonden – Uterine Probes**  
Hakenzangen  
Uterine Tenaculum Forceps

**EO**



TEALE

**EO180R**

255 mm, 9"



JACOBS

**EO202R**

215 mm, 8 1/2"



**Uterussonden – Uterine Probes**  
Hakenzangen  
Uterine Tenaculum Forceps

**EO**

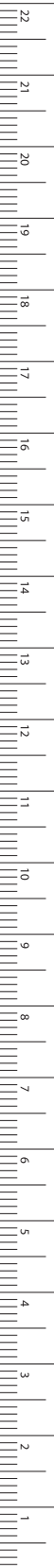

MILLIMETERS



LITTLEWOOD

**EO216R**

185 mm, 7 1/4"



MUSEUX

**EO218R**

200 mm, 8"

# Uterussonden – Uterine Probes

Hakenzangen

Uterine Tenaculum Forceps

EO

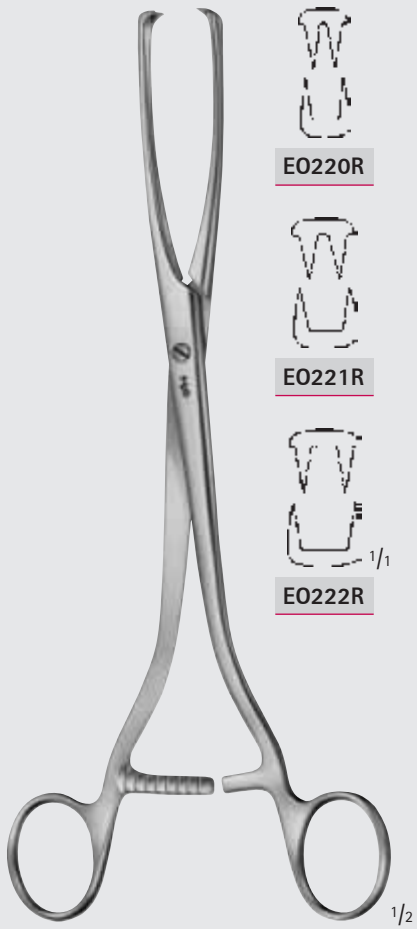

EO220R

EO221R

EO222R <sup>1/1</sup>

MUSEUX

EO220R-EO222R

240 mm, 9 1/2"

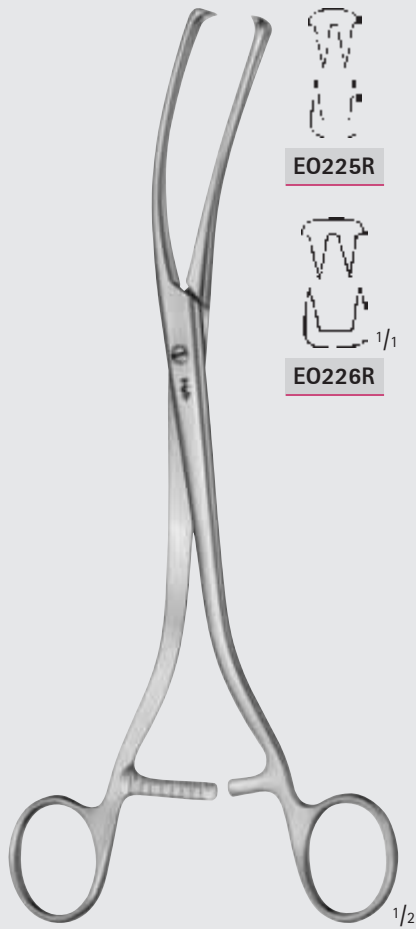

EO225R

EO226R <sup>1/1</sup>

MUSEUX

EO225R-EO226R

seitwärts gebogen  
curved to side  
240 mm, 9 1/2"

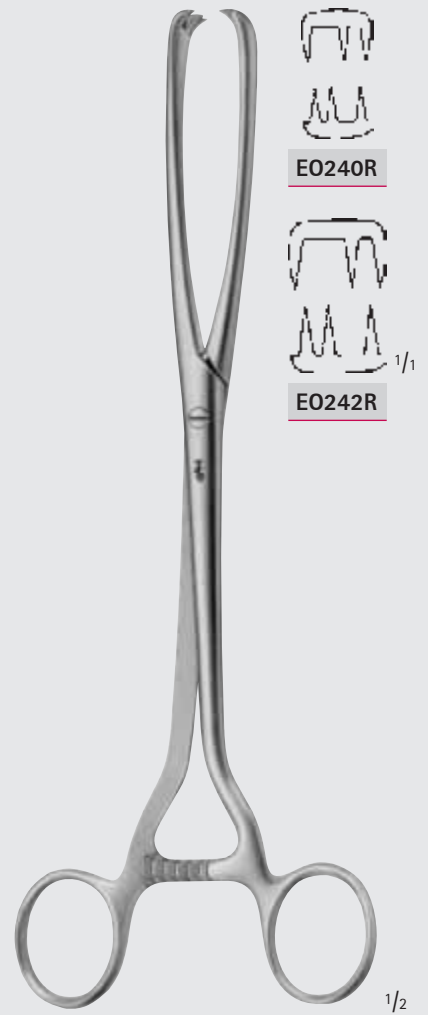

EO240R

EO242R <sup>1/1</sup>

MUSEUX

EO240R-EO242R

265 mm, 10 1/2"





**Uterussonden – Uterine Probes**  
Polypen- und Ovarienzangen  
Polypus- and Ovum Forceps

EO

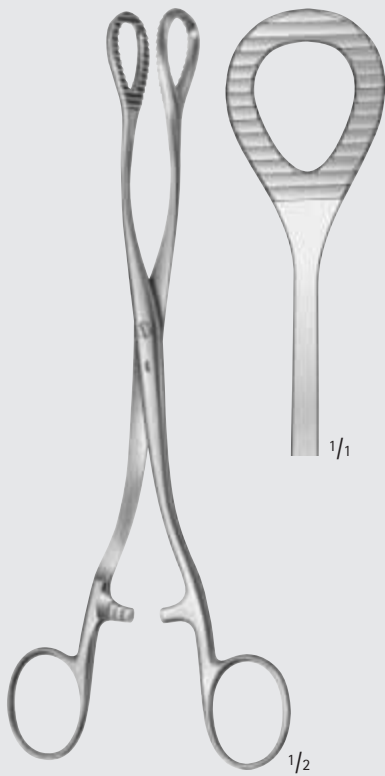

HEYWOOD-SMITH

**AN710R**

200 mm, 8"



KELLY

**BF135R**

320 mm, 12 3/4"

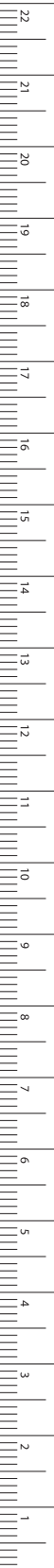

MILLIMETERS

## Uterussonden – Uterine Probes

Polypen- und Ovarienzangen

Polypus- and Ovum Forceps

EO

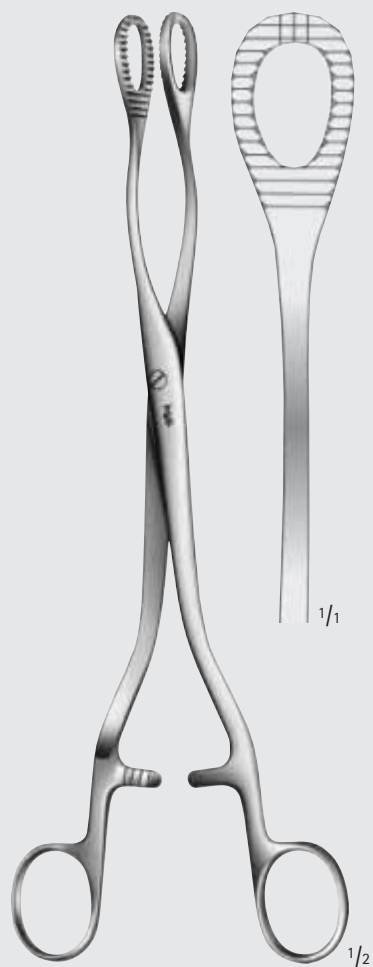

HEYWOOD-SMITH

**E0310R**

250 mm, 10"

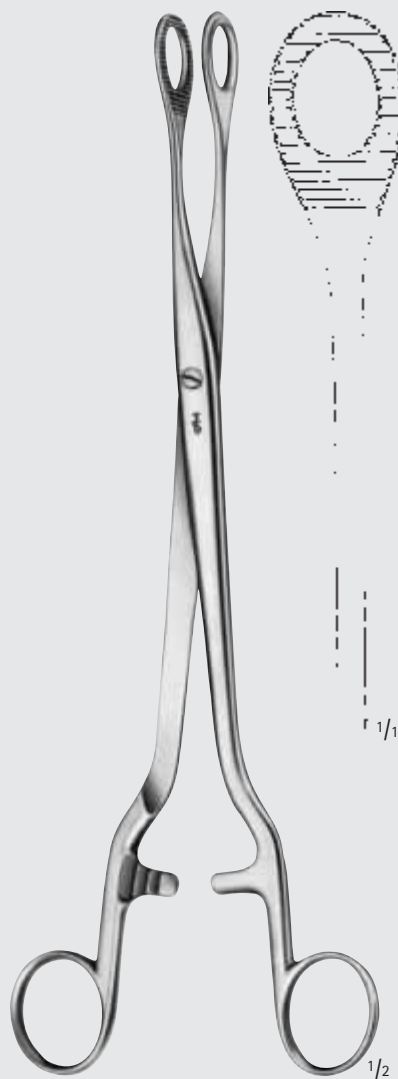

NOTO

**E0315R**

280 mm, 11"



**Uterussonden – Uterine Probes**  
 Polypen- und Ovarienzangen  
 Polypus- and Ovum Forceps

**EO**



MILLIMETERS



DOYEN

**EO332R**

185 mm, 7 1/4"

**AIRAUMATA®**



**EO338R** 250 mm 10"

**EO340R** 270 mm 10 3/4"

## Uterussonden – Uterine Probes

Polypen- und Ovarienzangen, Uterusfasszangen

Polypus- and Ovum Forceps, Uterine Elevating Forceps

EO

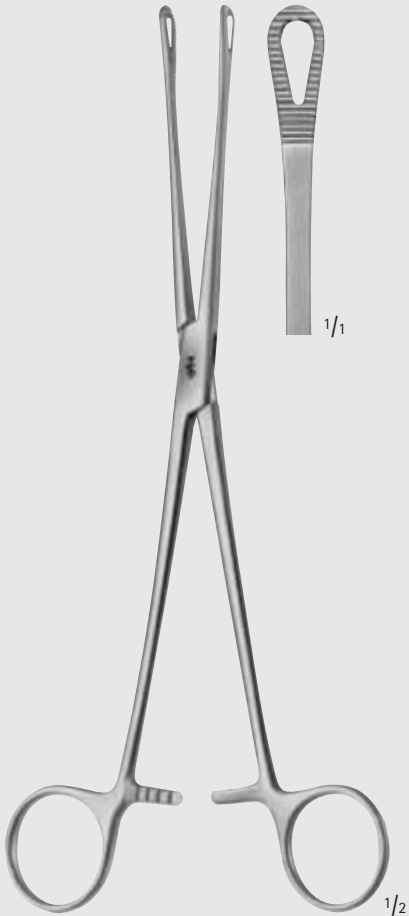

BONNEY

**EO342R**

240 mm, 9 1/2"



COLLIN

**EO300R**

250 mm, 10"



COLLIN

**EO405R**

285 mm, 11 1/4"



**Uterussonden – Uterine Probes**  
Uterusfazzangen  
Uterine Elevating Forceps

**EO**



1/2

DARTIGUES

**EO407R**

255 mm, 10"



1/2

SOMER

**EO415R**

235 mm, 9 1/4"



mit beweglichen Maulteilen  
with movable jaws

1/2

COLLIN

**EO420R**

265 mm, 10 1/2"

MILLIMETERS

## Uterussonden – Uterine Probes

Myomheber

Myoma Screws

EO



DOYEN

**EO433R**

150 mm, 6"



DOYEN

**EO435R**

190 mm, 7 1/2"



## Uterussonden – Uterine Probes

### Modifiziertes Instrumentarium für die Wertheimsche Operation Modified Instruments for Radical Hysterectomy

Die Austunnung des blasennahen Ureters und das Absetzen der Parametrien sind die charakteristischen Bestandteile bei der Wertheimschen Operation. Für das Austunneln des Ureters gibt es verschiedene Vorgehensweisen. Das Risiko der Ureter-Verletzung, das allen diesen Vorgehensweisen gemeinsam ist, ist bedingt durch das wiederholte Anklebmen, Spreizen und Durchtrennen von Gewebe in unmittelbarer Nähe des Ureters ohne direkte visuelle Kontrolle. Die Durchtrennung der Parametrien ist ein weiterer kritischer Operationsschritt. Das Durchtrennen der Gewebsbündel ist oft technisch unbefriedigend und hinterläßt gezahnte Resektionsränder. Aesculap hat daher ein Instrumentarium entwickelt, das die oben genannten operativen Schritte sicherer und präziser macht. Das Instrumentarium ermöglicht es dem Chirurgen, den Eingriff sicherer und präziser durchzuführen und daraus folgt ein schonender OP-Verlauf für die Patientin. Das bislang bestehende Risiko von ungewollten Verletzungen bei dieser Radikaloperation beim Zervixkarzinom wird durch das Design der von Aesculap entwickelten Instrumente minimiert.

Tunneling of the ureter and severance of the parametria are the characteristic components of the Wertheim operation. There are various procedures for tunnelling the ureter. The risk of injury to the ureter, which is common to all these procedures, is due to the repeated clamping, separation and severance of tissues in the immediate proximity of the ureter without direct visual monitoring. The severance of the parametria is another critical step in the operation. The severance of the tissue bundles is often technically unsatisfactory and leaves serrated resection edges. Aesculap has therefore developed an instrument set which makes the operating steps mentioned safer and more precise. The instrument set enables the surgeon to carry out the operation more safely and precisely, resulting in a less traumatic operation for the patient. The existing risk of undesired injuries in this radical operation for carcinoma of the cervix is minimized by the design of the instruments developed by Aesculap.

EO

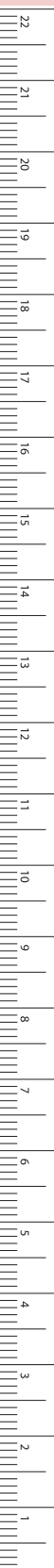

MILLIMETERS



UCHIDA (MODIF. N. BURKE)

<b>BM976R</b>	270 mm	10 3/4"
<b>BM977R</b>	350 mm	14"

Ureterlöffel  
Spoons



<b>BJ075R</b>	<b>BJ076R</b>
235 mm	350 mm
9 1/4"	14"

KIEBACK

**BJ075R-BJ076R**

Ureter-Tunnelier-Klemmen,  
seitwärts gebogen  
Ureteral tunnel clamps,  
curved to side

## Uterussonden – Uterine Probes

Modifiziertes Instrumentarium für die Wertheimsche Operation

Modified Instruments for Radical Hysterectomy

EO

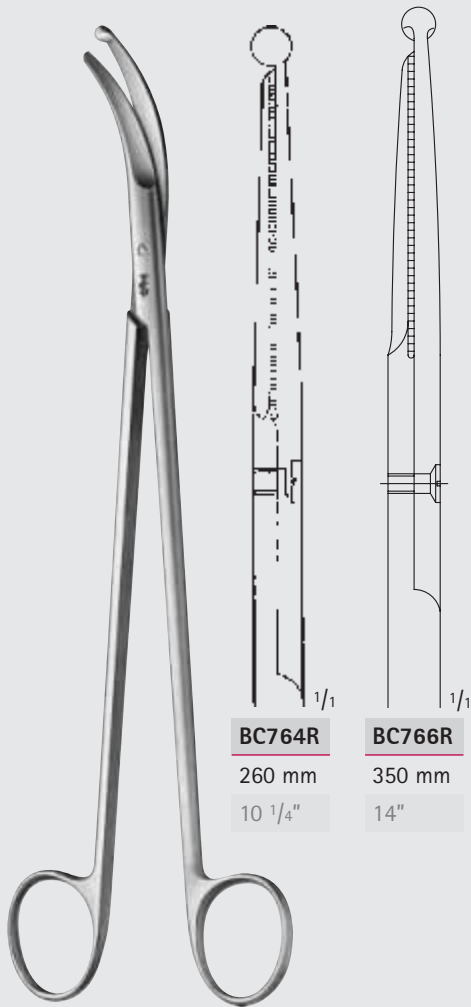

**BC764R**

260 mm

10 1/4"

**BC766R**

350 mm

14"

KIEBACK

**BC764R-BC766R**

Parametriumscheren, seitwärts gebogen, 1 Blatt mit Knopfspitze  
Parametrium scissors, curved to side, with 1 probe pointed blade



**BJ560R**

250 mm

10"

**BJ562R**

350 mm

14"

BURKE

**BJ560R-BJ562R**

Parametriumklemmen, kurzes Maul  
Parametrium clamps, short jaw part





## Uterussonden – Uterine Probes

Modifiziertes Instrumentarium für die Wertheimsche Operation  
Modified Instruments for Radical Hysterectomy

EO



**BJ561R**

250 mm

10"

**BJ563R**<sup>1/1</sup>

350 mm

14"

BURKE

**BJ561R-BJ563R**

Parametriumklemmen, langes Maul  
Parametrium clamps, long jaw part



**BC763R**

240 mm

9 1/2"

**BC765R**<sup>1/1</sup>

350 mm

14"

KIEBACK

**BC763R-BC765R**

Parametriumscheren  
Parametrium scissors

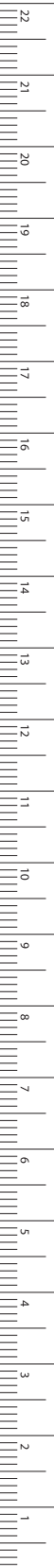

MILLIMETERS



INCHES

ER



**Biopsie- und Kürettage-Instrumente**  
Biopsy Instruments and Currettes

## Biopsie- und Kürettage-Instrumente – Biopsy Instruments and Curettes

### Skalpellgriffe und Skalpellklingen Scalpel Handles and Scalpel Blades

ER

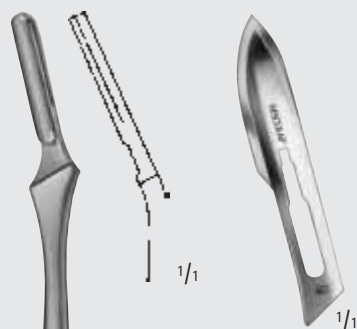

#### BB540

auswechselbare Skalpellklingen,  
doppelschneidig  
interchangeable scalpel  
blades, double cutting

Bestelleinheit:

PAK= Packung à 100 Stück

Sales unit:

PAK= Package of 100 pieces

#### BB079R

Skalpellgriff, winklig aufgebogen  
Scalpel handle, angular curved

1/1 225 mm, 9"





## Biopsie- und Kürettage-Instrumente – Biopsy Instruments and Curettes

Biopsieküretten, I.U.D.-Entfernungshaken

Biopsy Curettes, I.U.D. Removing Hook

ER

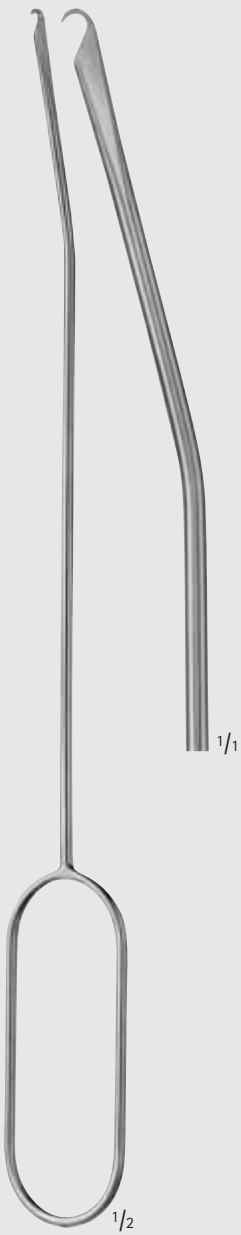

SAUNDERS

**ER002R**

I.U.D.-Entfernungshaken

I.U.D. Removing hook

320 mm, 12 1/2"

biegsam  
malleable



ASCH

**ER005R**

Sekretlöffel

Secretion scoop

200 mm, 8"

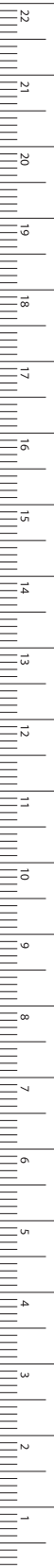

MILLIMETERS

# Biopsie- und Kürettage-Instrumente – Biopsy Instruments and Curettes

Biopsieküretten

Biopsy Curettes

ER



1/1



1/1

Luer-Lock  
Luer-Lock

Luer-Lock  
Luer-Lock

1/2

1/2

NOVAK-SCHOECKAERT

RANDALL

**ER011R**

**ER012R**

Endometrium-Biopsiekürette

Endometrium-Biopsiekürette

Endometrial biopsy curette

Endometrial biopsy curette

240 mm, 9 1/2"

240 mm, 9 1/2"



1/1  
Ø 3,5 mm  
diam. 3.5 mm



1/1  
Ø 4,0 mm  
diam. 4.0 mm

1/2

1/2

MOD. BERLIN

MOD. MÜNCHEN

**ER015R**

**ER016R**

Endometrium-Strickkürette

Endometrium-Strickkürette

Endometrial biopsy curette

Endometrial biopsy curette

270 mm, 10 3/4"

270 mm, 10 3/4"



## Biopsie- und Kürettage-Instrumente – Biopsy Instruments and Curettes

Biopsiezangen  
Biopsy Forceps

ER

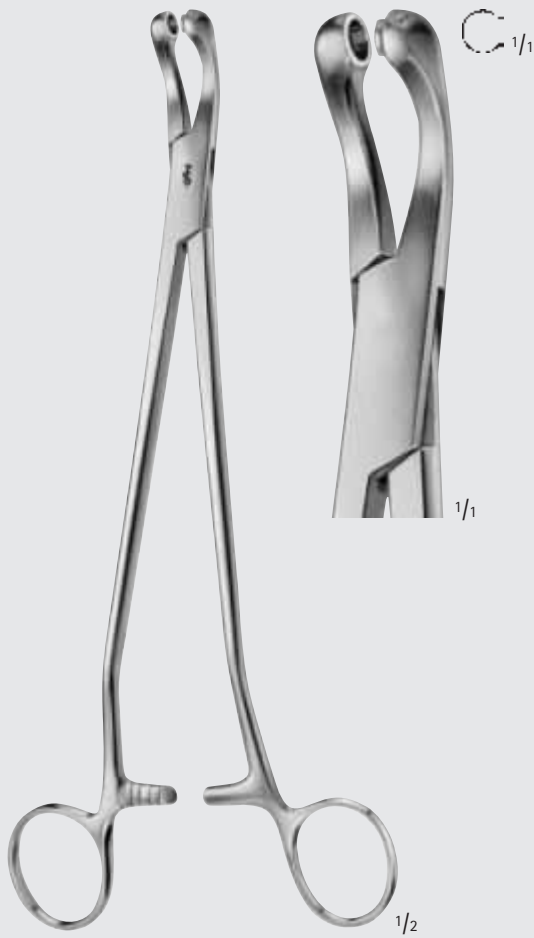

THOMS-GAYLOR

**ER050R**

240 mm, 9 1/2"

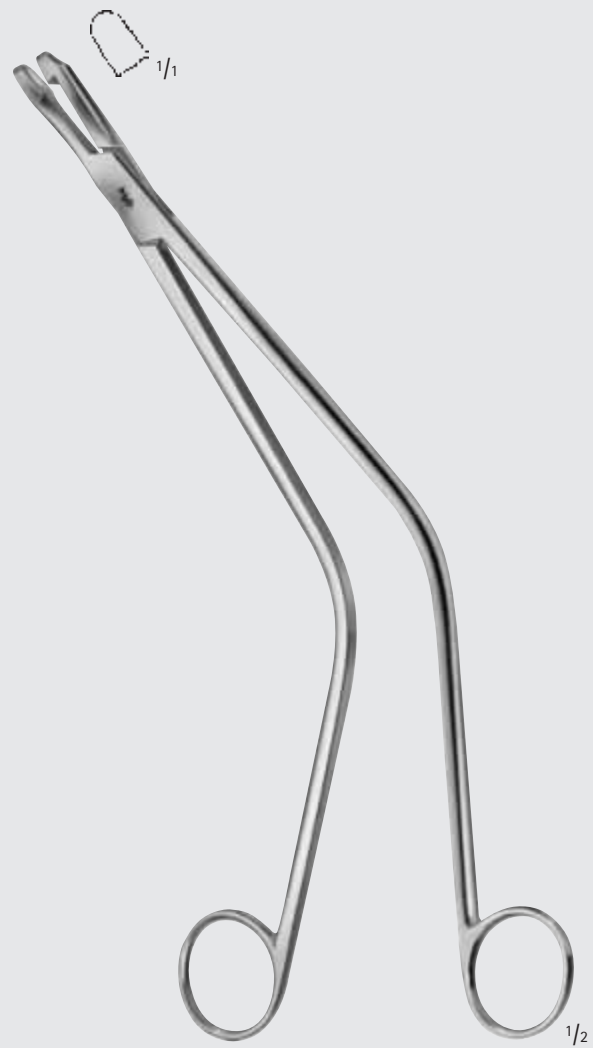

SCHUBERT

**ER058R**

260 mm, 10 1/4"

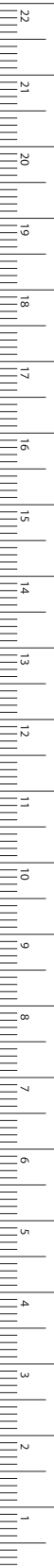

MILLIMETERS

# Biopsie- und Kürettage-Instrumente – Biopsy Instruments and Currettes

Biopsiezangen  
Biopsy Forceps

ER



FAURE

**ER054R**

210 mm, 8 1/4"

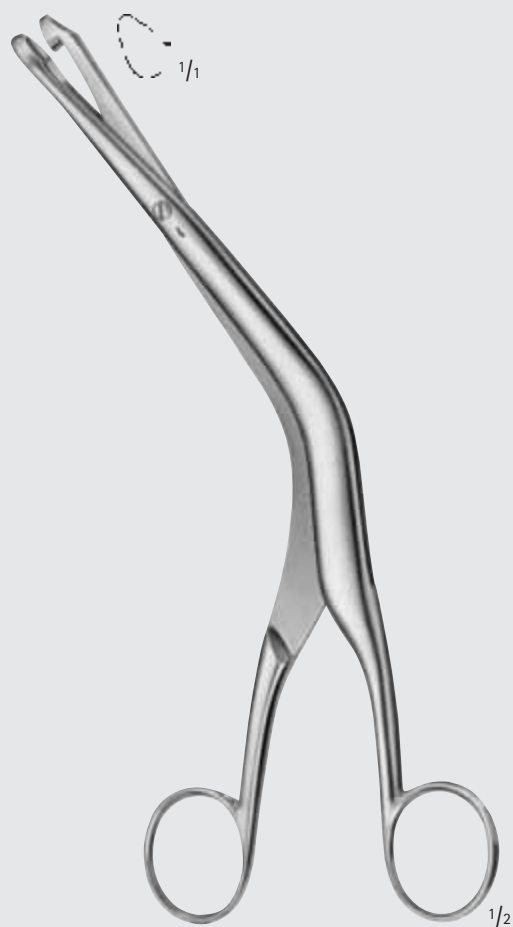

FAURE

**ER055R**

240 mm, 9 1/2"





# Biopsie- und Kürettage-Instrumente – Biopsy Instruments and Curettes

## Biopsiezangen Biopsy Forceps

Vorteile der SCHUMACHER-Zangen:

- Sicheres Erfassen des Gewebes aufgrund des Anhakeeffekts.
- Großer Öffnungswinkel.
- Glatter, ziehender Schnitt.
- Proben werden nicht gequetscht.
- Nicht schmerzhaft, selbstschließende Wunde, gute Heilung.

Advantages of the Schumacher forceps:

- More reliable grip on the tissue due to "hooking" effect.
- Wide angle of opening.
- Smooth, steady cut.
- Specimens are not squashed.
- Not painful; self-sealing wound, heals well.

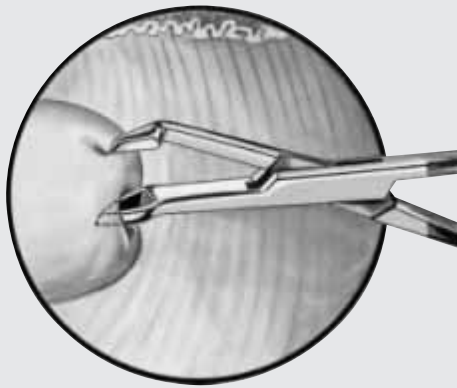

Zange an der Portio vaginalis uteri angesetzt.  
Der gute Anhakeeffekt ist erkennbar.

Forceps applied to the portio vaginalis uteri.  
The excellent hooking effect can be seen.

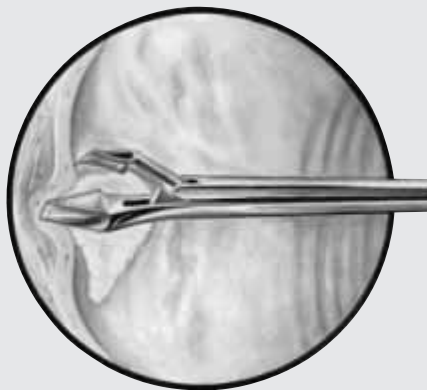

Zange am narbig veränderten flachen  
Scheidengewölbe angesetzt.

Forceps applied to cicatricially altered flat  
vaginal vault.

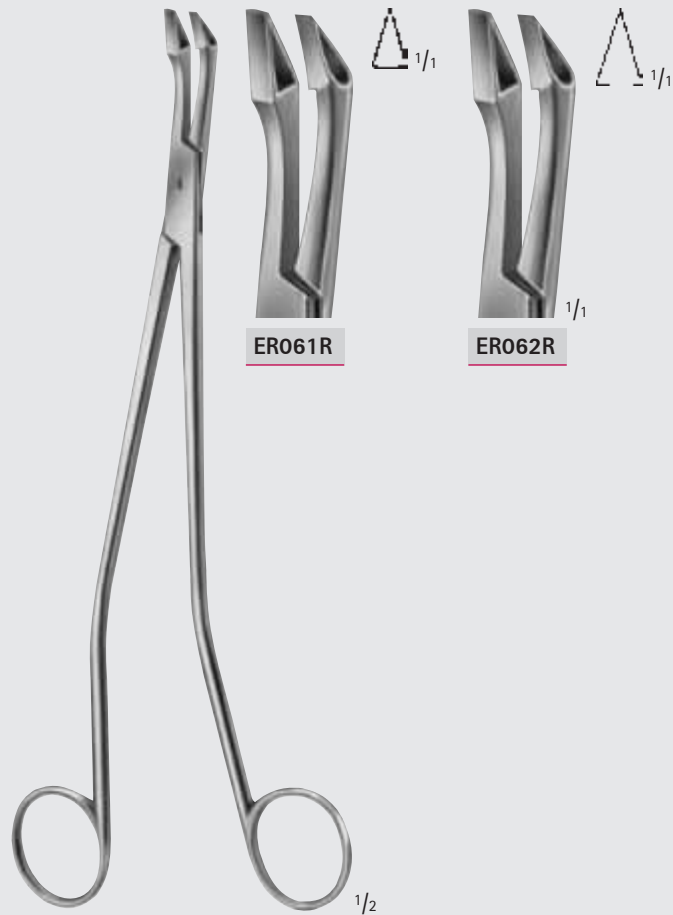

SCHUMACHER

**ER061R-ER062R**

240 mm, 9 1/2"

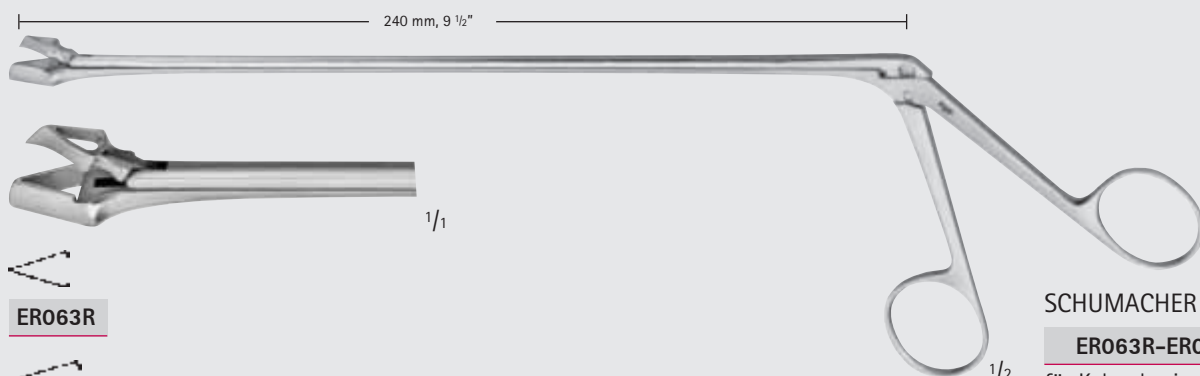

**ER063R**

**ER064R**

SCHUMACHER

**ER063R-ER064R**

für Kolposkopie geeignet  
suitable for colposcopy  
240 mm, 9 1/2"

ER

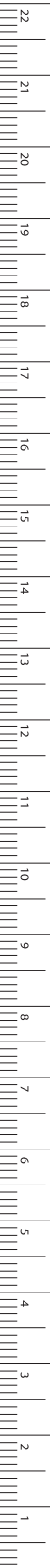

MILLIMETERS

## Biopsie- und Kürettage-Instrumente – Biopsy Instruments and Currettes

### Biopsiezangen Biopsy Forceps

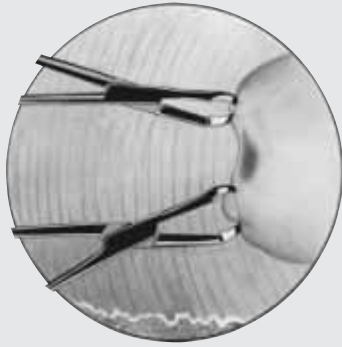

Die Größe des PE-Stücks wird durch den Öffnungswinkel der Zange bestimmt. Der Anhakeeffekt des gebogenen Zangenmaules ermöglicht eine Gewebeatnahme meist ohne zusätzliche Verwendung einer fixierenden Hakenzange.

The size of the biopsy is determined by the opening angle of the forceps. The hook effect of the curved jaws allows tissue removal and an additional hook forceps is hardly ever necessary.

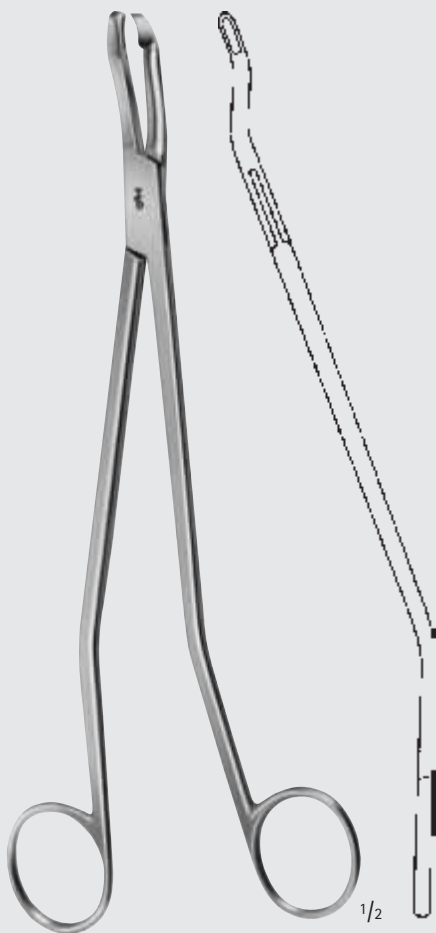

SEIDL DBP

**ER072R-ER076R**

Biopsiezangen, bajonettförmig,  
für Portio, Vagina und Vulva

Biopsy forceps, bayonet-shaped,  
for portio, vagina and vulva

240 mm, 9 1/2"

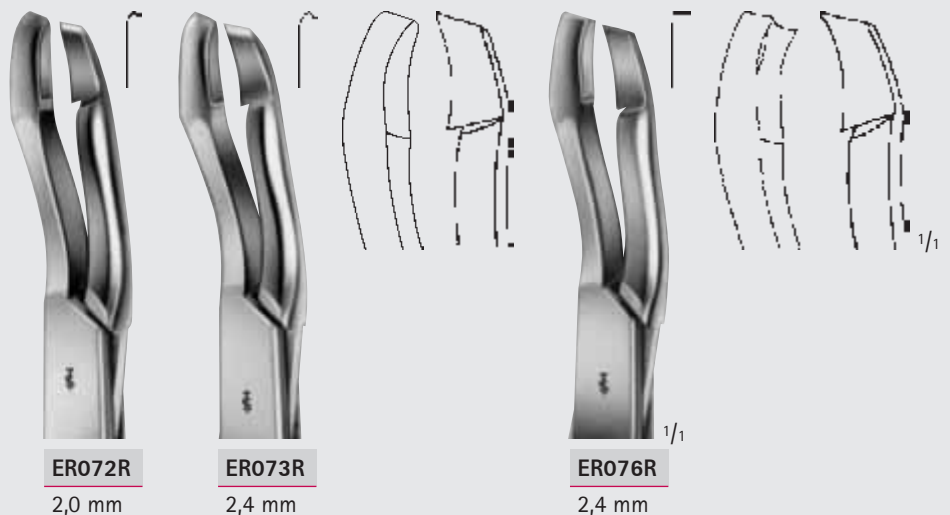

**ER072R**  
2,0 mm

**ER073R**  
2,4 mm

**ER076R**  
2,4 mm

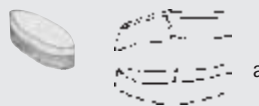

■ Es stehen zwei Maulformen zur Verfügung:

- a) Gotische Form (verursacht weniger Blutung), 2,0 bzw. 2,4 mm breit
- b) Rechteckige Form, 2,4 mm breit

■ Die glatte, senkrechte Schnittführung durch Epithel und Bindegewebe ermöglicht eine optimale histologische Untersuchung. Das PE-Stück wird seitlich auf einer planen Unterlage (z.B. Kork) fixiert und kann so "schnittgerecht" eingebettet werden. Keine tangentialen Anschnitte!

■ Durch die Bajonettbiegung bleibt die Sicht (mit oder ohne Kolposkop) auf die Portio bzw. das PE-Gebiet frei. Das Ansetzen der Zange kann gut kontrolliert werden.



■ 2 different shapes of the jaw are available:  
a) gothic shape (causes less bleeding)

2.0 resp. 2.4 mm wide

b) rectangular shape, 2.4 mm wide

■ The smooth vertical cut through the epithelium and fibrous tissue allows an immediate histological examination. The biopsy is laterally fixed to a plane support (e.g. cork) and can thus properly be embedded for intersection. No tangential incisions.

■ The bayonet-shape of the forceps does neither obstruct the view to the portio nor to the area of biopsy, no matter whether a colposcope is used or not. Application of the forceps can be well controlled.



## Biopsie- und Kürettage-Instrumente – Biopsy Instruments and Curettes

Biopsiezangen  
Biopsy Forceps

ER

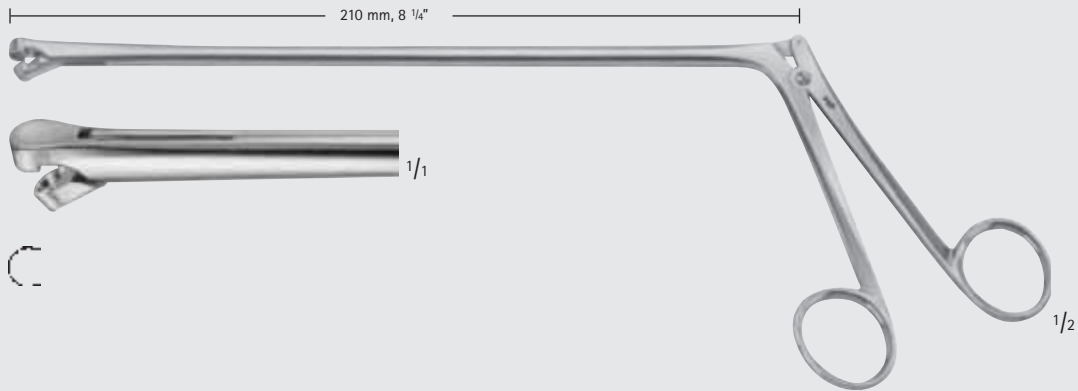

BERGER

**ER066R**

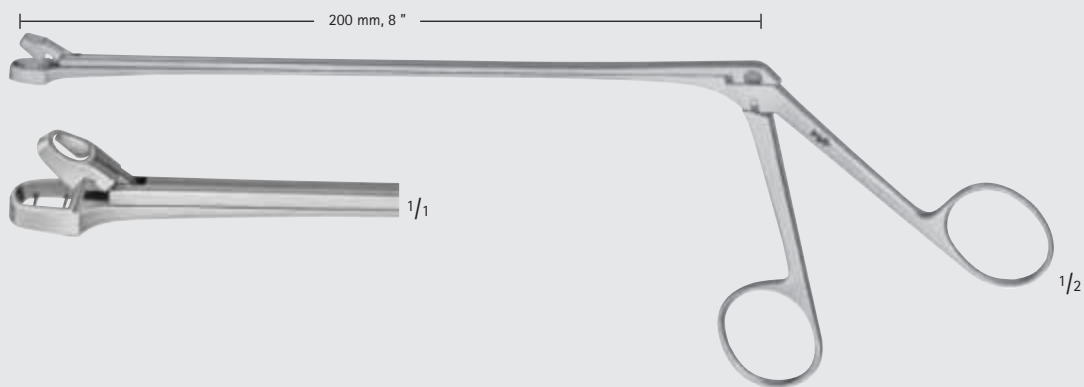

EPPENDORF

**ER070R**

für Kolposkopie geeignet  
suitable for colposcopy

MILLIMETERS

## Biopsie- und Kürettage-Instrumente – Biopsy Instruments and Curettes

Biopsiezangen

Biopsy Forceps

ER

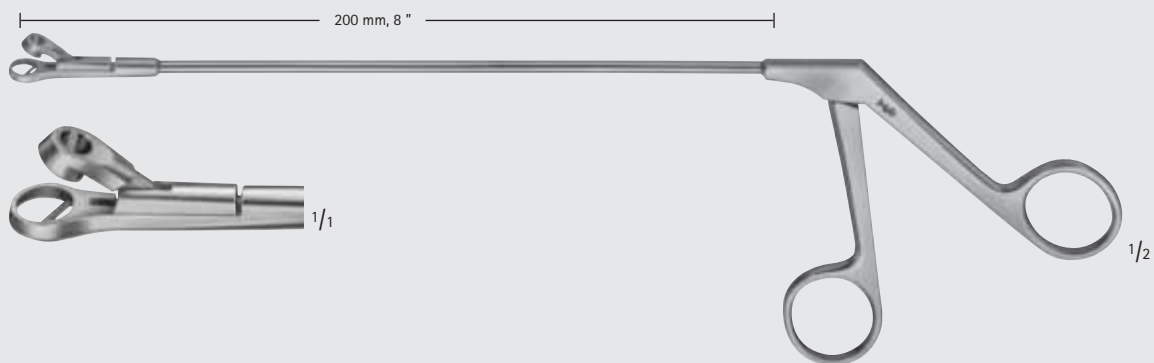

LEECH-WILKINSON

ER071R

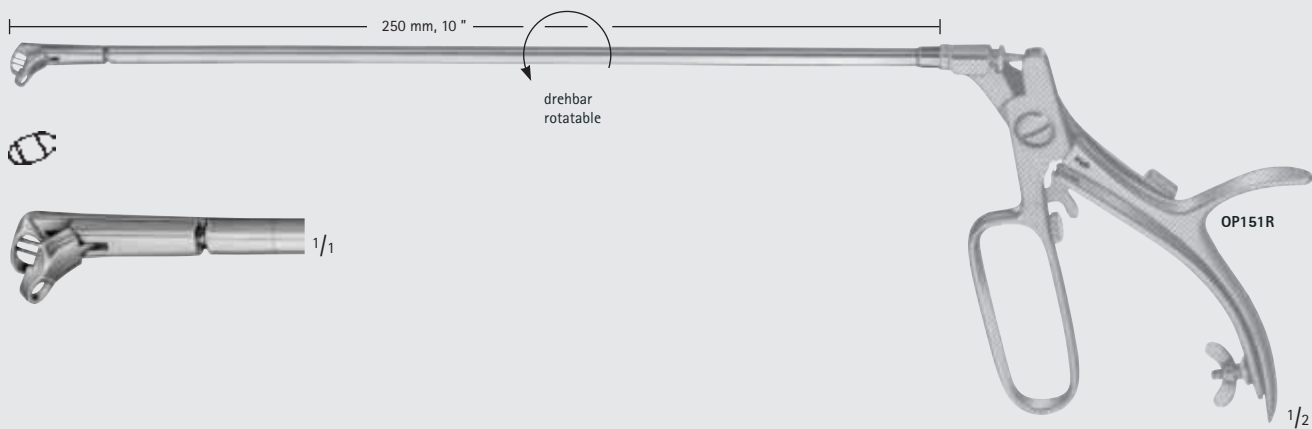

AESCULAP

EA912R

Aufsatz allein  
mit ziehendem Schnitt,  
passend auf Griff OP151R

Attachment only  
with cut beginning from the top,  
suitable for handle OP151R



# Biopsie- und Kürettage-Instrumente – Biopsy Instruments and Curettes

Biopsiezangen  
Biopsy Forceps

ER



AESCULAP

**OP151R**

Universalgriff  
Universal handle  
140 mm, 5 1/2"



HUBER

**OP152R**

Universalgriff  
Universal handle  
140 mm, 5 1/2"



BRÜNNINGS

**OP160R** 200 mm, 8"

**OP161R** 250 mm, 10"

Verlängerungsrohre  
Extension cannula



**OP222R**



**OP223R**

KRAUSE

**OP222R-OP223R**

Biopsie-Aufsätze  
Biopsy attachments



SCHUMACHER

**OP230R**

Biopsie-Aufsatz  
mit ziehendem Schnitt  
Biopsy attachment  
with cut beginning from  
the top

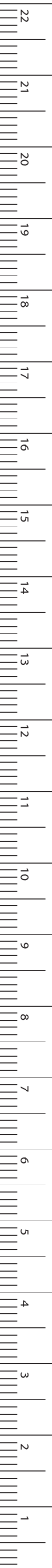

MILLIMETERS

# Biopsie- und Kürettage-Instrumente – Biopsy Instruments and Currettes

Biopsiezangen

Biopsy Forceps

ER

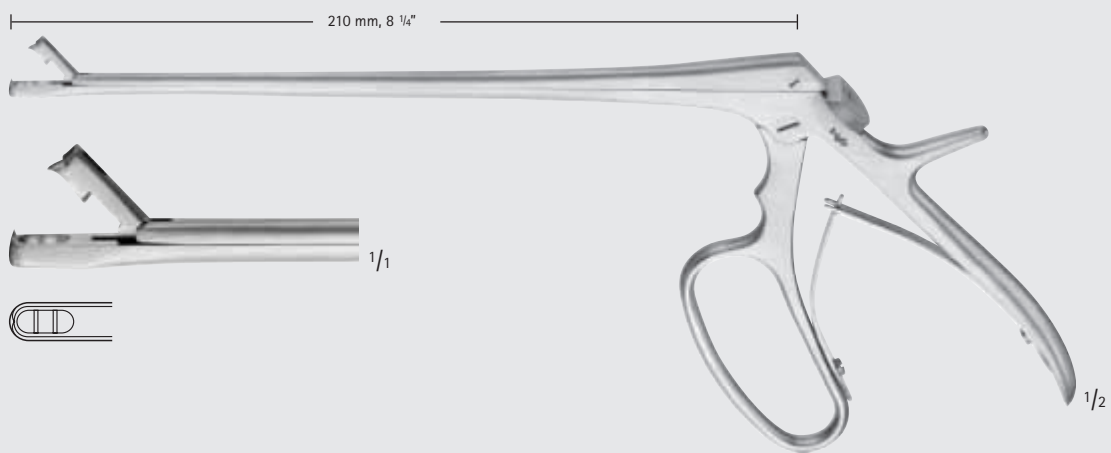

TISCHLER

ER068R



# Biopsie- und Kürettage-Instrumente – Biopsy Instruments and Curettes

Uteruslöffel  
Uterine Scoops

ER

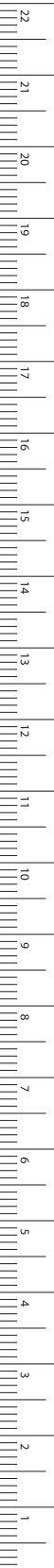

MILLIMETERS



Fig. 1

**ER101R**  
6,8 mm



Fig. 2

**ER102R**  
8,5 mm



Fig. 3

**ER103R**  
10 mm



Fig. 4

**ER104R**  
11,5 mm



Fig. 5

**ER105R**  
13 mm



Fig. 6

**ER106R**  
14,5 mm

SIMON

**ER101R-ER106R**  
max. 240 mm, 9 1/2"



Fig. 1

**ER111R**  
6,8 mm



Fig. 2

**ER112R**  
8,5 mm



Fig. 3

**ER113R**  
10 mm



Fig. 4

**ER114R**  
11,5 mm



Fig. 5

**ER115R**  
13 mm

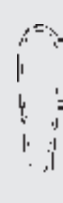

Fig. 6

**ER116R**  
14,5 mm

SCHRÖDER

**ER111R-ER116R**  
max. 310 mm, 12 3/8"



**ER126R**  
6 mm



**ER128R**  
8 mm



**ER130R**  
10 mm

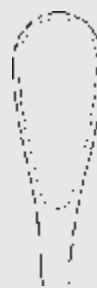

**ER132R**  
12 mm



**ER134R**  
14 mm

GOURDET

**ER126R-ER134R**  
stumpf  
blunt  
280 mm, 11"

# Biopsie- und Kürettage-Instrumente – Biopsy Instruments and Curettes

Uterusküretten

Uterine Curettes

ER



RECAMIER

**ER219R-ER230R**

scharf-fest  
sharp-rigid

**ER241R-ER248R**

scharf-biegsam  
sharp-malleable

**ER320R-ER330R**

stumpf-fest  
blunt-rigid  
max. 300 mm, 12"

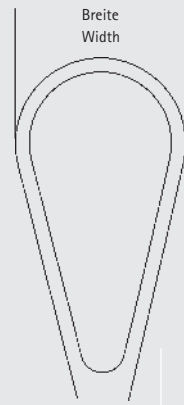
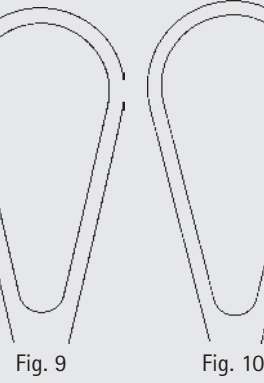
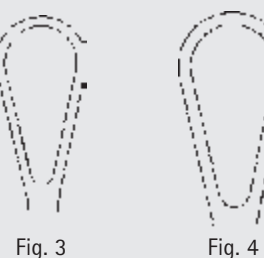
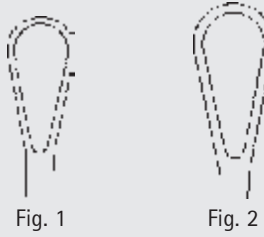
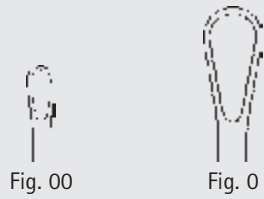

Fig.	Breite Width	scharf sharp		stumpf blunt
		fest rigid	biegsam malleable	fest rigid
00	4,5 mm	<b>ER219R</b>		
0	7,5 mm	<b>ER220R</b>		<b>ER320R</b>
1	8,5 mm	<b>ER221R</b>	<b>ER241R</b>	<b>ER321R</b>
2	10,5 mm	<b>ER222R</b>	<b>ER242R</b>	<b>ER322R</b>
3	12,0 mm	<b>ER223R</b>	<b>ER243R</b>	<b>ER323R</b>
4	14,0 mm	<b>ER224R</b>	<b>ER244R</b>	<b>ER324R</b>
5	15,0 mm	<b>ER225R</b>	<b>ER245R</b>	<b>ER325R</b>
6	16,5 mm	<b>ER226R</b>	<b>ER246R</b>	<b>ER326R</b>
7	18,0 mm	<b>ER227R</b>	<b>ER247R</b>	<b>ER327R</b>
8	19,5 mm	<b>ER228R</b>	<b>ER248R</b>	<b>ER328R</b>
9	21,5 mm	<b>ER229R</b>		<b>ER329R</b>
10	23,5 mm	<b>ER230R</b>		<b>ER330R</b>





# Biopsie- und Kürettage-Instrumente – Biopsy Instruments and Curettes

Uterusküretten  
Uterine Curettes

ER

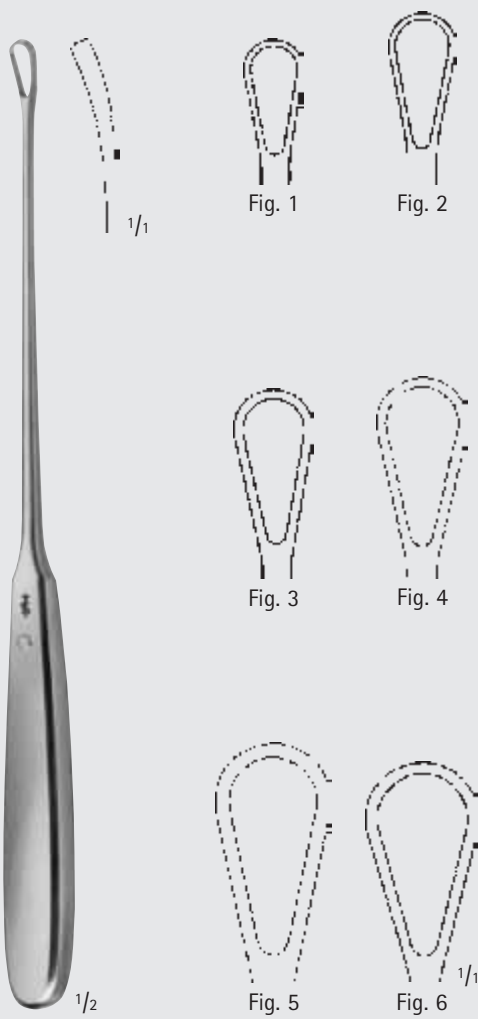

SIMS

**ER401R-ER406R**

scharf-fest  
sharp-rigid

**ER411R-ER416R**

scharf-biegsam  
sharp-malleable  
max. 255 mm, 10"

**ER421R-ER426R**

stumpf-fest  
blunt-rigid

Fig.	Breite Width	scharf sharp		stumpf blunt
		fest rigid	biegsam malleable	fest rigid
1	7,5 mm	ER401R	ER411R	ER421R
2	8,5 mm	ER402R	ER412R	ER422R
3	10,5 mm	ER403R	ER413R	ER423R
4	12,0 mm	ER404R	ER414R	ER424R
5	14,0 mm	ER405R	ER415R	ER425R
6	15,0 mm	ER406R	ER416R	ER426R

MILLIMETERS

# Biopsie- und Kürettage-Instrumente – Biopsy Instruments and Curettes

Uterusküretten

Uterine Curettes

ER



1/2

BUMM

**ER520R-ER526R**

stumpf-biegsam

blunt-malleable

max . 290 mm, 11 1/2"



Fig. 0



Fig. 1



Fig. 2

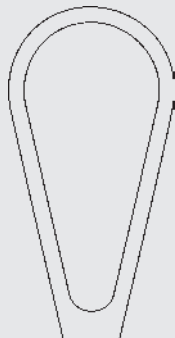

Fig. 3

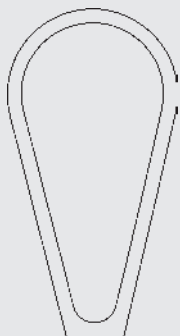

Fig. 4



Fig. 5



Fig. 6

1/1

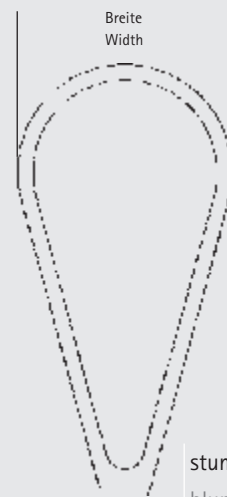

Fig.	Breite Width	stumpf blunt	biegsam malleable
0	16,0 mm	<b>ER520R</b>	
1	18,0 mm	<b>ER521R</b>	
2	19,5 mm	<b>ER522R</b>	
3	21,5 mm	<b>ER523R</b>	
4	23,5 mm	<b>ER524R</b>	
5	26,0 mm	<b>ER525R</b>	
6	28,5 mm	<b>ER526R</b>	



## Biopsie- und Kürettage-Instrumente – Biopsy Instruments and Currettes

Uterusküretten, Plazentar- und Abortusküretten

Uterine Currettes, Placenta- and Ovum Currettes

ER



BLAKE

ER585R

275 mm, 10 3/4"



COLLIN

ER580R

300 mm, 12"



HEANEY

ER025R

240 mm, 9 5/8"

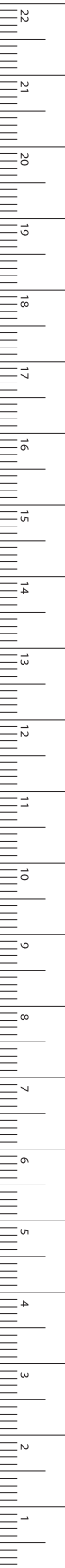

MILLIMETERS

## Biopsie- und Kürettage-Instrumente – Biopsy Instruments and Currettes

Plazentar- und Abortuslöffel

Placenta- and Ovum Scoop

ER

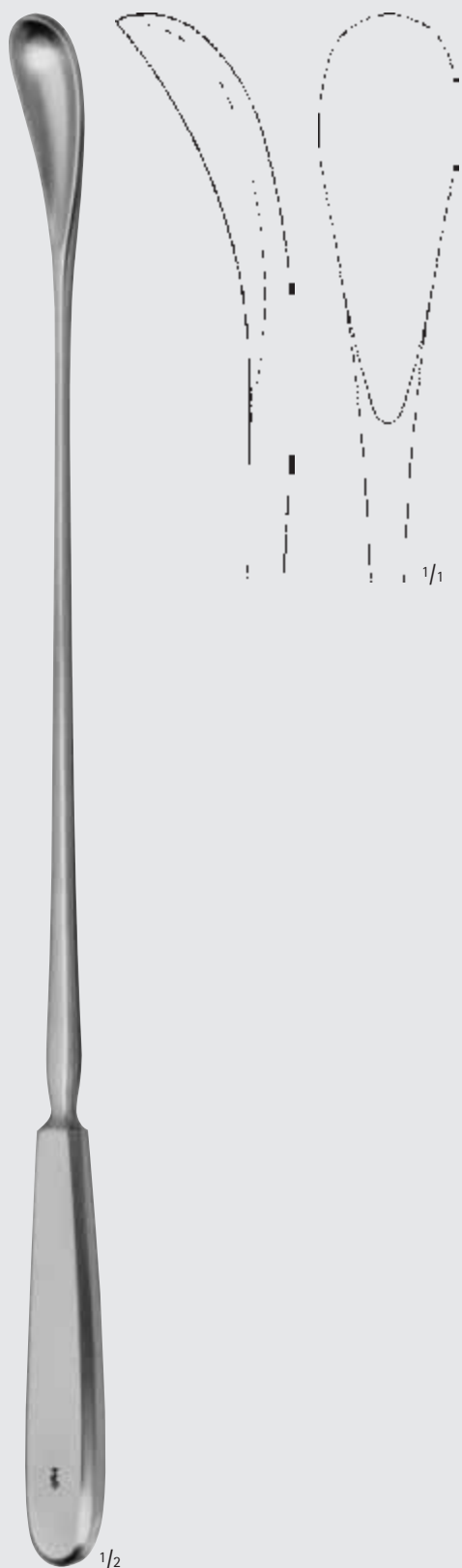

1/2

WALLICH

ER602R

420 mm, 16 3/4"

## Biopsie- und Kürettage-Instrumente – Biopsy Instruments and Currettes

Plazentar- und Abortusküretten

Placenta- and Ovum Currettes

ER

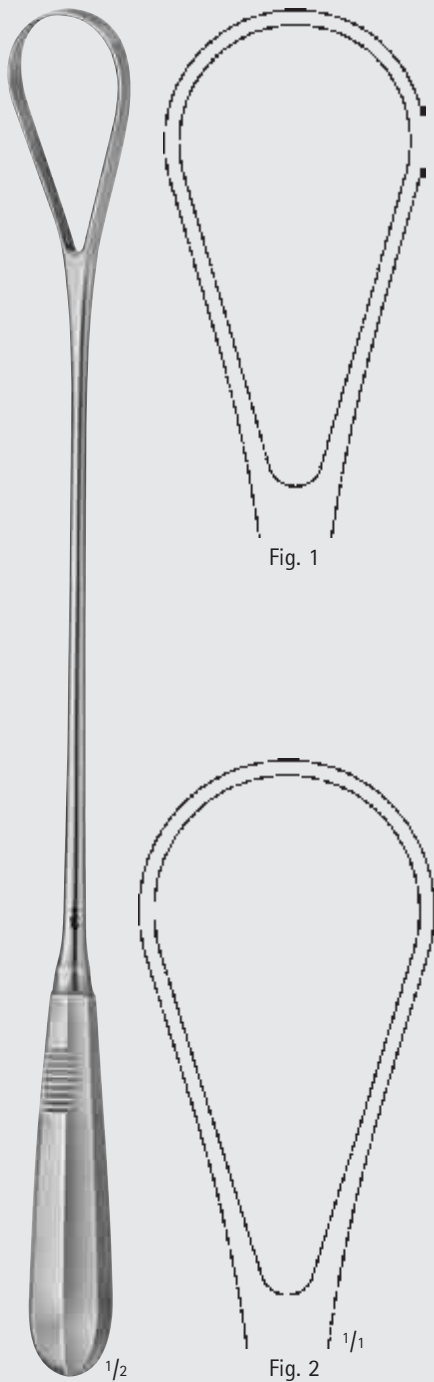

RECAMIER

**ER611R-ER612R**

stumpf-fest  
blunt-rigid  
max. 360 mm, 14 <sup>3</sup>/<sub>8</sub>"

Fig.	Breite Width	fest rigid	stumpf blunt
1	34,5 mm	<b>ER611R</b>	
2	39,5 mm	<b>ER612R</b>	

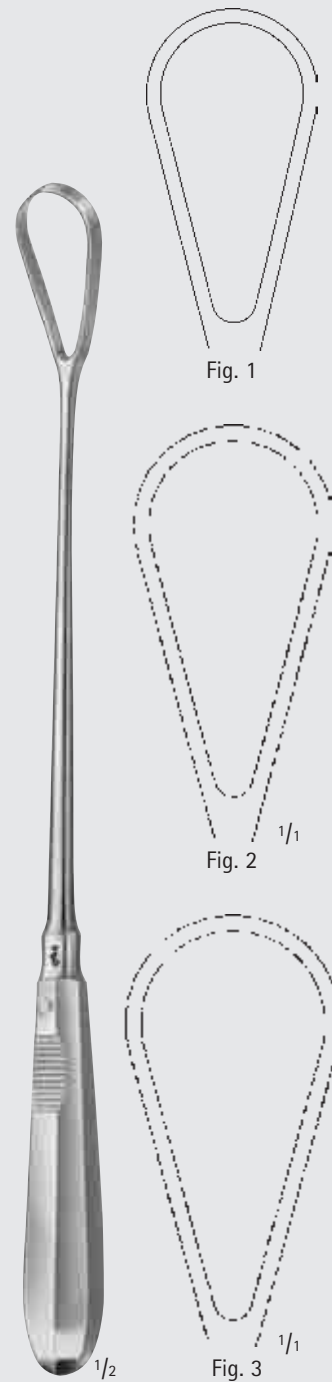

BUMM

**ER621R-ER623R**

scharf-biegsam  
sharp-malleable

**ER626R-ER628R**  
stumpf-biegsam  
blunt-malleable  
max. 310 mm, 12 <sup>3</sup>/<sub>8</sub>"

Fig.	Breite Width	scharf sharp	stumpf blunt
1	23,5 mm	<b>ER621R</b>	<b>ER626R</b>
2	26,0 mm		<b>ER627R</b>
3	28,5 mm	<b>ER623R</b>	<b>ER628R</b>



MILLIMETERS

## Biopsie- und Kürettage-Instrumente – Biopsy Instruments and Curettes

### Vakuümküretten

### Vacuum Curettes

Kanülen zur Vakuümkürettage mit Graduierung und Saugunterbrecher, passend auf den Schlauchansatz GF720R. Arbeitstenden sorgfältig verrundet, daher keine Perforationsgefahr.

Curettes with graduation and suction interrupter, for vacuum curettage, fitting hose connection GF720R. Working tips are smoothly rounded off, therefore no danger of perforation.



Ø  
diam.  
4 mm (zur Saugbiopsie geeignet)  
(suitable for suction biopsy)

<b>GF704R</b>	
<b>GF706R</b>	6 mm
<b>GF708R</b>	8 mm
<b>GF710R</b>	10 mm
<b>GF712R</b>	12 mm
<b>GF714R</b>	14 mm

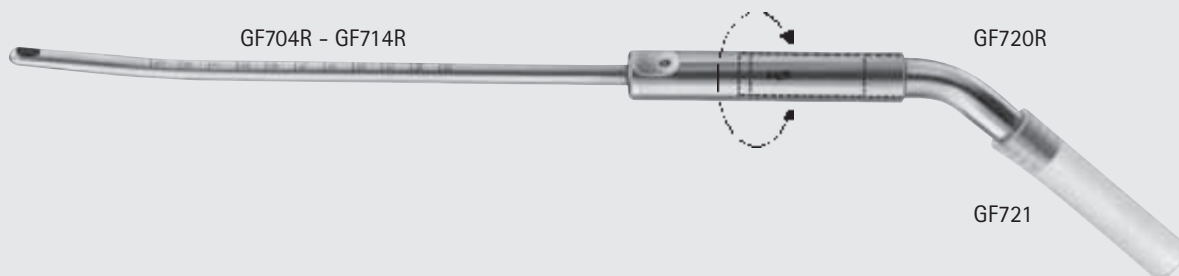

GF704R - GF714R

GF720R

GF721



**GF720R**

Schlauchansatz, gebogen  
Innen-Ø: 11 mm  
Hose connection, curved  
inside diam.: 11 mm



**GF721**

Saugschlauch, transparent, 1,8 m lang, Innen-Ø 11 mm, Außen-Ø 16,5 mm, sterilisierbar im Autoklav bei 143 °C (3 bar)

Die Verbindung zwischen Saugküretten und Schlauchansatz GF720R gewährleistet schnelles Wechseln und freies Drehen der Saugküretten auf dem Schlauchansatz.

The connection between suction curette and hose connection GF720R guarantees quick changing and free turning of the suction curettes on the hose connection.

Transparent suction hose, 1.8 m long, inside diam. 11 mm, outside diam. 16.5 mm, can be sterilized in an autoclave at 143 °C (3 bar)



**GF722**

Gewebe-Auffangsieb aus Kunststoff, zum Einmalgebrauch für die histopathologische Untersuchung.

Strainer for tissues, plastic, for single use only, to be used for histopathological examination.

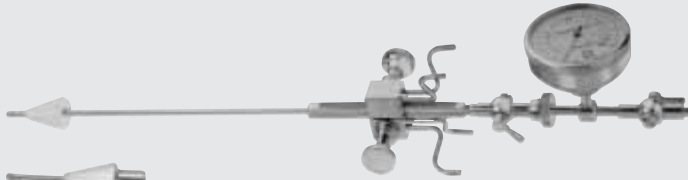
**ER826C**

**ER827C**

**ER828C**
**SCHULZE**
**ER820C**

Salpingograph zur Hystereo-Salpingographie, komplett bestehend aus:

- ER825C Tubenkatheter mit Hahn, ohne Kegel
- ER826C Kegel allein, klein
- ER827C Kegel allein, mittel
- ER828C Kegel allein, groß
- Manometer
- Zwischenstück
- ER829 Holzetui

Salpingograph, for utero-salpingography, complete consisting of:

- ER825 C Uterine cannula with tap without cone
- ER826C Cone only, small
- ER827C Cone only, medium
- ER828C Cone only, large
- Manometer
- Connection
- ER829 Wooden case

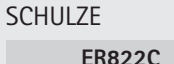
**SCHULZE**
**ER822C**

Salpingograph, Ausstattung wie ER820C, jedoch ohne Manometer

Salpingograph, equipment like ER820C, but without manometer

## Biopsie- und Kürettage-Instrumente – Biopsy Instruments and Curettes

Uterus-Kanülen

Uterine Cannulae

ER



$\frac{1}{2}$

LEECH-WILKINSON

**ER871R-ER873R**

265 mm, 10  $\frac{1}{2}$ "

**ER871R**

klein

small

Ø 10 x 25 mm

diam. 10 x 25 mm

**ER872R**

mittel

medium

Ø 13 x 30 mm

diam. 13 x 30 mm

**ER873R**

groß

large

Ø 16 x 30 mm

diam. 16 x 30 mm

$\frac{1}{1}$



$\frac{1}{2}$

SPACKMAN

**ER874R**

mit Befestigungsplatte für  
Hakenzange verstellbar

with adjustable plate for  
vulsellum forceps

360 mm, 14  $\frac{1}{4}$ "



## Biopsie- und Kürettage-Instrumente – Biopsy Instruments and Curettes

Uterus-Kanülen, Spülkatheter  
Uterine Cannulae, Irrigation Catheter

ER



BEHRMAN

**ER875**

Uterus-Kanüle  
mit abnehmbarem Konus  
Uterine cannula  
with detachable cone  
305 mm, 12"



**ER876**

Uterus-Kanüle  
mit Federmechanismus, selbsthaltend,  
komplett mit 2 auswechselbaren Koni  
groß und klein  
Uterine cannula  
with spring connector, self-retaining,  
complete with 2 interchangeable cones  
large and small  
250 mm, 13"



ROTUNDA

**ER867R**

Spülkatheter  
Ø 5 mm  
Irrigation cannula  
diam. 5 mm  
200 mm, 8"

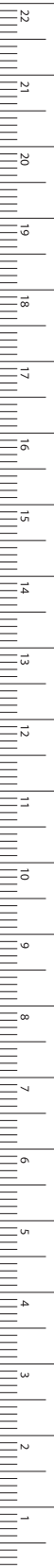

MILLIMETERS



INCHES



ET

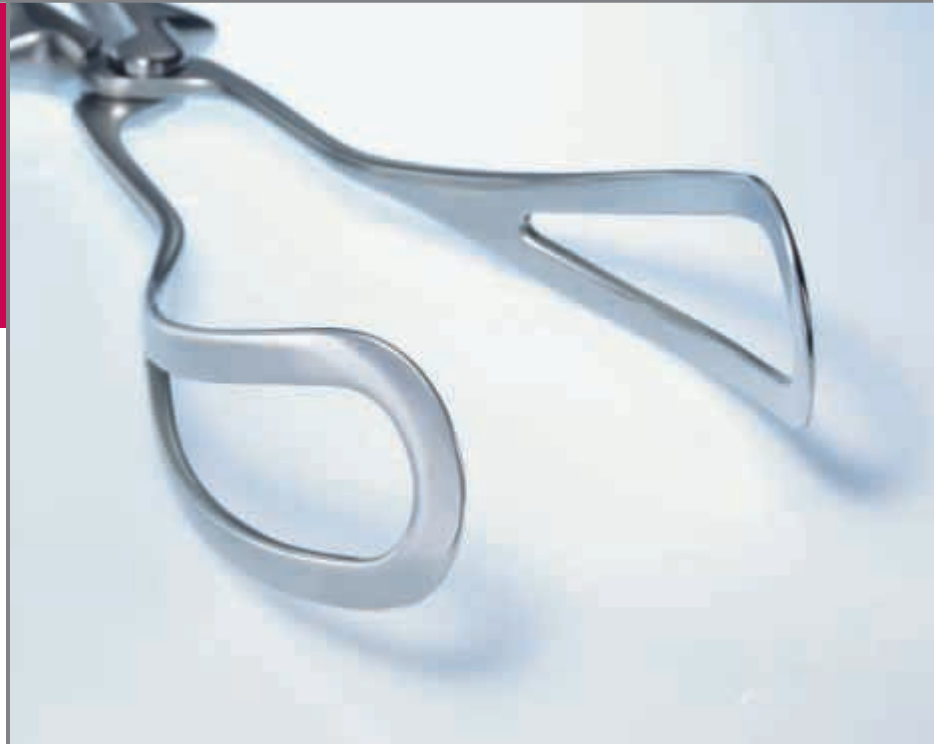

Geburtshilfe  
Obstetrics

## Geburtshilfe – Obstetrics

Beckenzirkel

Pelvimeters



DE LEE

**ET005R**

Beckenzirkel mit Zentimeter- und Zolleinteilung für innere Messungen zwischen Symphyse und Promontorium

Pelvimeter graduated in centimeters and inches for interior measurements between symphysis and promontory

$\frac{1}{2}$



MARTIN

**ET073R**

mit Zentimereinteilung graduated in centimeters

$\frac{1}{3}$



SCHMELZ

**ET002**

Rechenscheibe  
Gestation calculator

$\frac{1}{3}$

Nach Applikation der Führungshülse am Injektionsort wird die Kanüle (mit aufgesetzter Spritze) durch den Trichter bzw. durch die Hülse hindurchgeführt und ins Gewebe eingestochen. Verletzungen der Vagina werden dabei vermieden. Die Einstichtiefe ist auf ca. 10 mm begrenzt. Ein Daumenring sowie eine kleine Stütze für Zeige- oder Mittelfinger dienen zur besseren Handhabung. Der Daumenring ist auf der Führungshülse verschiebbar und kann mit einer Rändelmutter – für jede Hand passend – fixiert werden. Die Fingerstütze läßt sich um die Führungshülse drehen und ermöglicht dadurch die Verwendung sowohl für Rechts- als auch für Linkshänder. Außerdem kann die Fingerstütze – evtl. bei der Pudendusnästhesie – ganz aus dem Aktionsbereich heraus in Richtung Daumenring geschoben werden.

When the guide sheath is introduced at the spot to be injected the needle (mounted on the syringe) is passed through the guide sheath and the tissue is finally injected. Injuries of the vagina are thus avoided. Depth of puncture is limited to 10 mm. Thumb ring as well as a small support for middle- or forefinger facilitate the handling. Thumb ring slides on the guide sheath and can be fixed by a knurled nut to any size of the hand. The finger support can be turned round on the guide sheath so left-handers can use it, too. Completely away from the range of actions is the finger support when it is moved towards the thumb ring, e.g. for anesthesia of the pudendus.



**ET096R**

Führungshülse  
Guide sheath  
175 mm, 7"

**SR580R**

Injektionskanüle Luer-Lock  
Injection needle Luer-Lock hub  
1,0 x 185 mm

Spezialbesteck zur transvaginalen  
Injektion bei Paracervical-und  
Pudendusnästhesie

Special set for transvaginal injection  
for paracervical anesthesia as well  
as anesthesia of the pudendus



## Geburtshilfe – Obstetrics

Amniotom, Blasensprenger

Amniotome, Membrane Puncturing Forceps

Stethoskope für die Geburtshilfe siehe Rubrik AC

Obstetrical stethoscopes see section AC

ET



1/2

BEACHAM

ET102R

Amniotom

Amniotome

240 mm, 9 1/2"

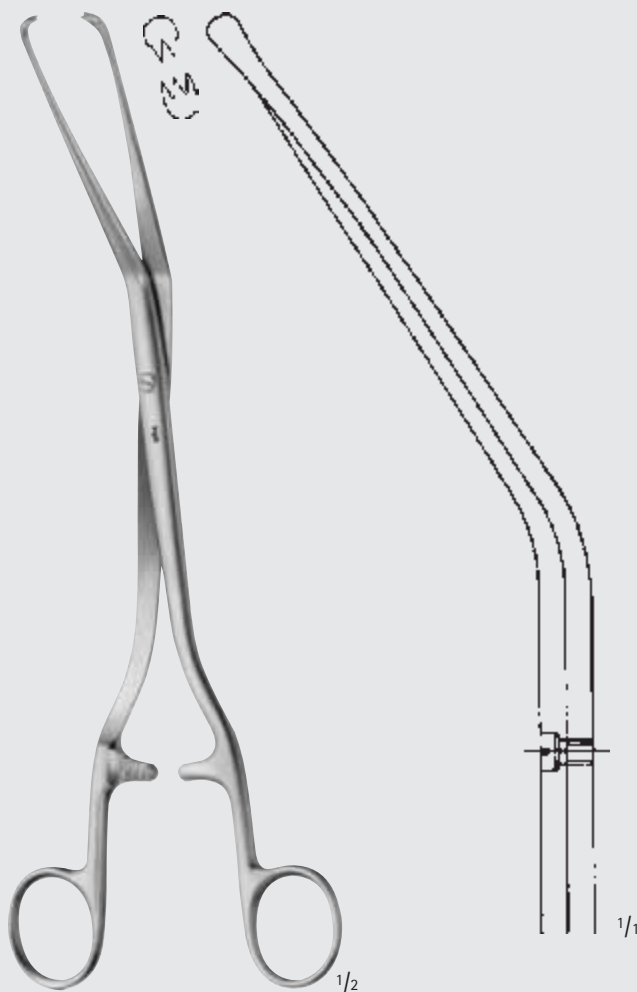

1/2

HERFF

ET106R

Blasensprenger

Membrane puncturing forceps

255 mm, 10"



**Geburtshilfe – Obstetrics**  
 Nabelschnurscheren  
 Umbilical Cord Scissors

**ET**

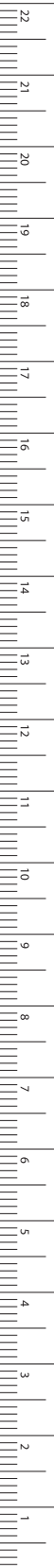

MILLIMETERS



**SCHUHMACHER**

**ET150R**

Nabelschnurschere  
 Umbilical cord scissors  
 155 mm, 6"

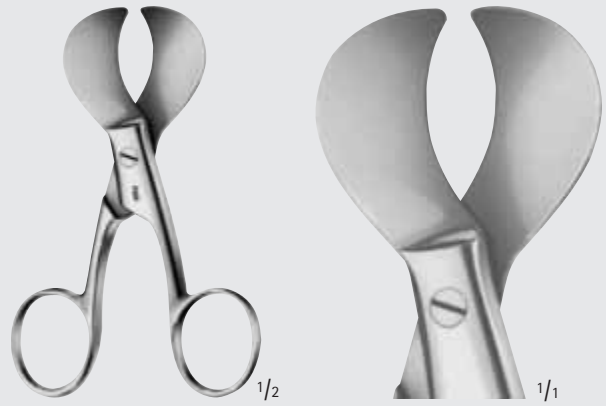

**ET152R**

Nabelschnurschere  
 Umbilical cord scissors  
 105 mm, 4 1/8"

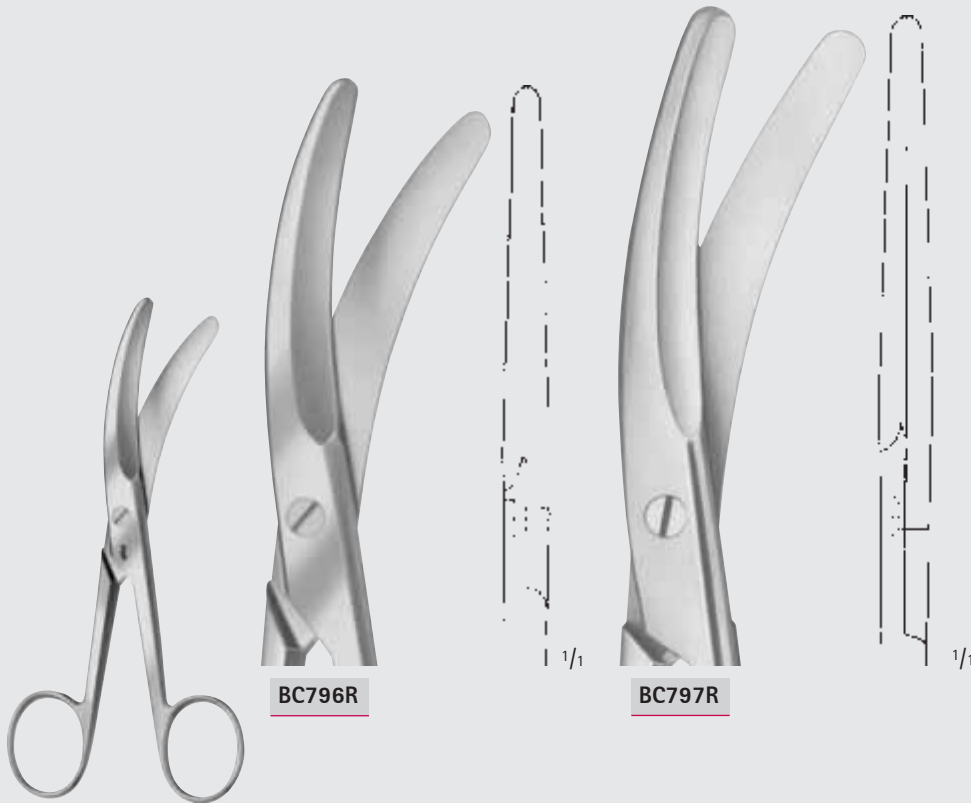

**BC796R**

**BC797R**

<b>BC796R</b>	135 mm	5 1/4"
<b>BC797R</b>	160 mm	6 1/4"

Nabelschnurscheren  
 Umbilical cord scissors

## Geburtshilfe – Obstetrics

Dammscheren, Nabelschnurdilatator, Nabelschnurklemme  
 Episiotomy Scissors, Umbilical Dilator, Umbilical Cord Clamp



BRAUN-STADLER

ET140R 145 mm 5 3/4"

ET141R 200 mm 8"

Dammscheren

Episiotomy scissors



ET140R

1/1

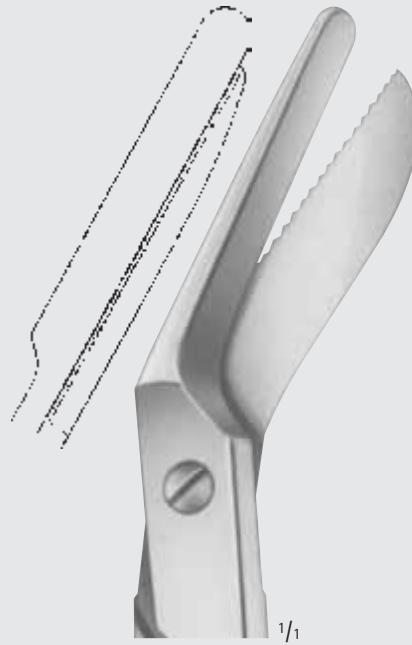

ET141R

1/1



ET142R

Dammschere  
 Episiotomy scissors  
 240 mm, 9 1/2"

1/2



1/1

ET130R

Nabelschnurdilatator  
 Umbilical dilator  
 95 mm, 3 3/4"



1/2

COLLIN

ET160R

Nabelschnurklemme  
 Umbilical cord clamp  
 85 mm, 3 3/8"





## Geburtshilfe – Obstetrics

### Vakuum-Extraktion bei der Geburtshilfe Vacuum Extraction for Obstetrics

13

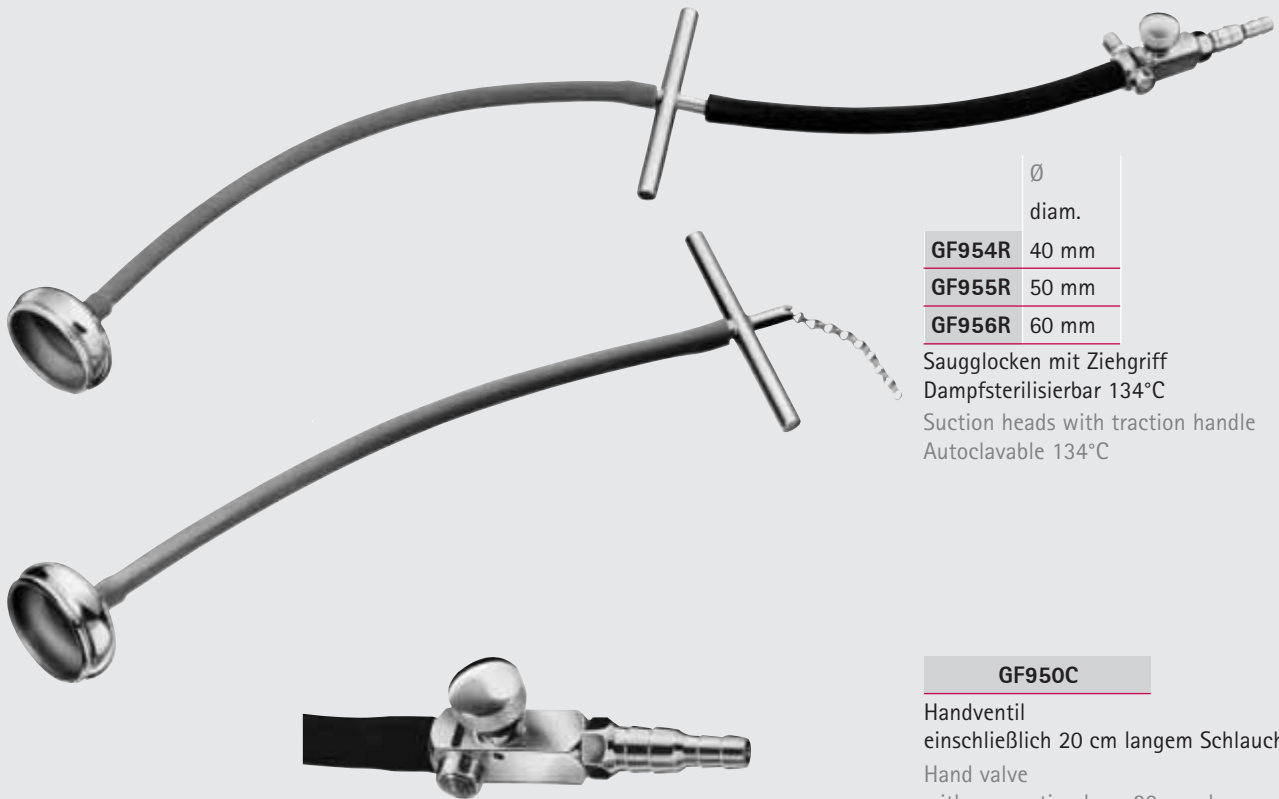

	Ø diam.
<b>GF954R</b>	40 mm
<b>GF955R</b>	50 mm
<b>GF956R</b>	60 mm

Sauglocken mit Ziehgriff  
Dampfsterilisierbar 134°C  
Suction heads with traction handle  
Autoclavable 134°C

#### **GF950C**

Handventil  
einschließlich 20 cm langem Schlauch  
Hand valve  
with connection hose 20 cms long

Mit dem Handventil GF950C können die Aesculap-Sauger auch zur Vakuum-Extraktion nach Malmström verwendet werden. Das Vakuum-Handventil GF950C ist auch an zentrale Sauganlagen anschließbar.

With the hand valve GF950C Aesculap electric suction pumps can also be used for Malmström vacuum extraction. The vacuum hand valve GF950C can also be connected to central suction system.

Funktionsweise: Das benötigte Vakuum ist durch die Regulierschraube beliebig voreinstellbar und veränderbar und besteht bis zum geschlossenen Stoppschieber. Sobald man den Stoppschieber öffnet, d.h. von links nach rechts drückt, wird die aufgesetzte Saugglocke unmittelbar unter das eingestellte Vakuum gesetzt. Zum sofortigen Absetzen der Saugglocke braucht der Stoppschieber nur geschlossen zu werden, wodurch das Vakuum der Saugglocke spontan zusammenbricht, während das Vakuum in der Saugflasche voll erhalten bleibt und nicht immer wieder zeitraubend neu aufgebaut werden muß.

Function: The vacuum required can be constantly preset by the adjusting screw. This vacuum exists then up to the closed quick-shutter, thus the vacuum in the suction head is pressed from the left to the right, the mounted suction head is immediately put under the preset vacuum. In case the preset vacuum has to be changed, this can be done with the adjusting screw. For immediate removal of the suction head simply close the quick-shutter, thus the vacuum in the suction head is eliminated at once whereas the vacuum in the suction jar remains unchanged.



#### **GF957**

Saugglocke aus Silicon-Gummi, Ø 60 mm,  
mit 1,5 m Siliconschlauch  
Dampfsterilisierbar 134°C  
Suction head, made of silicone, 60 mm diam.,  
with silicone tube 1.5 m long  
Autoclavable 134°C



MILLIMETERS

## Geburtshilfe – Obstetrics

Geburtszangen

Obstetrical Forceps

ET

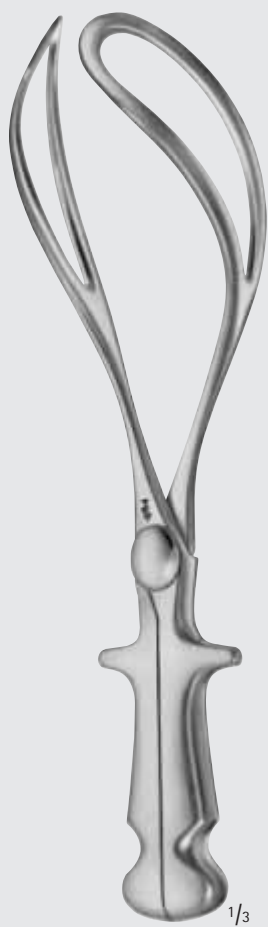

NÄGELE

ET205R

355 mm, 14 <sup>1</sup>/<sub>8</sub>"



KIELLAND

ET210R

420 mm, 16 <sup>3</sup>/<sub>4</sub>"



SIMPSON-BRAUN

**ET220R**

305 mm, 12"



SIMPSON-BRAUN

**ET221R**

350 mm, 14"



PIPER

**ET237R**

für nachkommenden  
Kopf bei Steißblagen  
for delivery of the after  
coming head in breech  
presentation  
445 mm, 17 1/2"

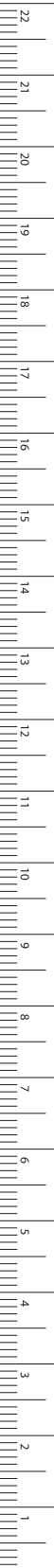

MILLIMETERS

## Geburtshilfe – Obstetrics

Geburtszangen

Obstetrical Forceps

ET



SIMPSON

**ET245R**

für sectio caesarea  
(Schnittentbindung)  
for caesarean section

235 mm, 9 1/4"

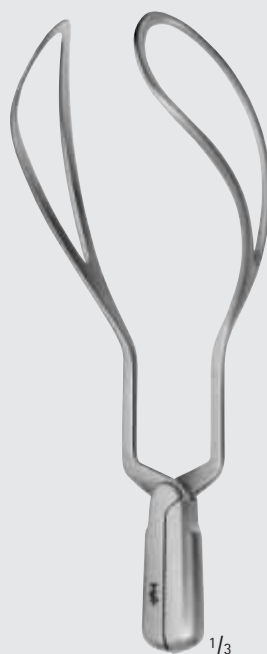

WRIGLEY

**ET246R**

für sectio caesarea  
(Schnittentbindung)  
for caesarean section

250 mm, 10"



**Geburtshilfe – Obstetrics**  
Geburtszangen  
Obsterical Forceps

ET

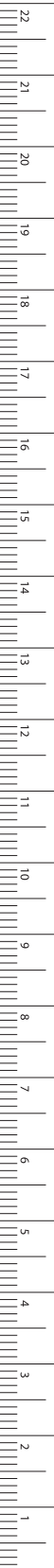

MILLIMETERS



1/3

TARNIER

**ET251R**

mit Achsenzugvorrichtung  
with traction rod  
400 mm, 16"



1/3

BARNES-NEVILLE

**ET255R**

mit Zugvorrichtung  
with traction handle  
435 mm, 17"

## Geburtshilfe – Obstetrics

Geburtslöffel, Uterus-Klemmzange

Obstetrics Lever, Caesarean Section Hemostatic Forceps

ET



SELLHEIM

**ET270R**

Geburtslöffel  
Obstetric lever  
300 mm, 12"

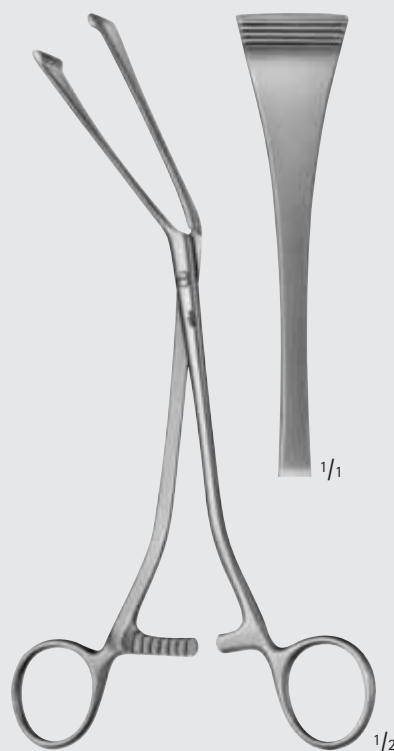

GREEN-ARMYTAGE

**ET268R**

Uterus-Klemmzange, abgewinkelt,  
zur Blutstillung an den Schnitt-  
rändern im unteren Segment bei  
Kaiserschnitt-Entbindungen  
Caesarean section hemostatic  
forceps, angled,  
for edges of the transverse  
incision in the lower segment  
195 mm, 7 3/4"



## Geburtshilfe – Obstetrics

Uterus-Klemmzange, Kopfschwartenzange  
Caesarean Hemostasis Forceps, Scalp Flap Forceps

ET

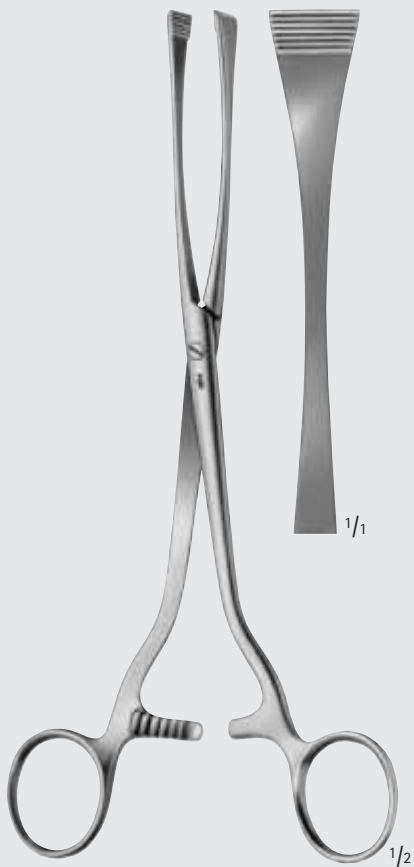

### GREEN-ARMYTAGE

**ET269R**

Uterus-Klemmzange zur Blutstillung an den Schnittträndern im unteren Segment bei Kaiserschnitt-Entbindungen

Caesarean section haemostatic forceps, for edges of the transverse incision in the lower segment

220 mm, 8 <sup>3</sup>/<sub>4</sub>"

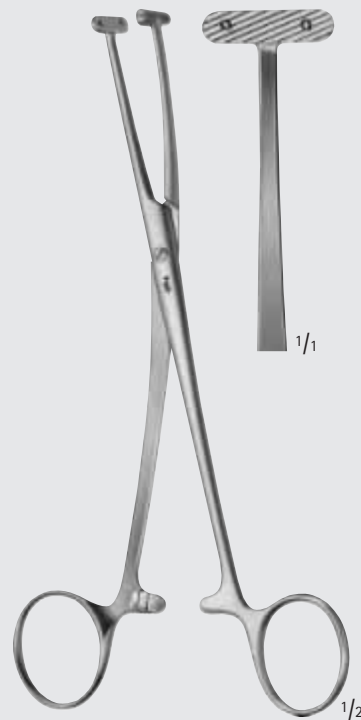

### WILLETT

**FF011R**

Kopfschwartenzange

Scalp flap forceps

185 mm, 7 <sup>1</sup>/<sub>4</sub>"

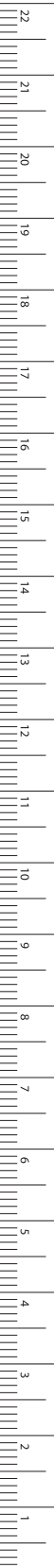

MILLIMETERS

**Geburtshilfe – Obstetrics**  
 Plazentar- und Abortuszangen  
 Placenta- and Ovum Forceps

ET

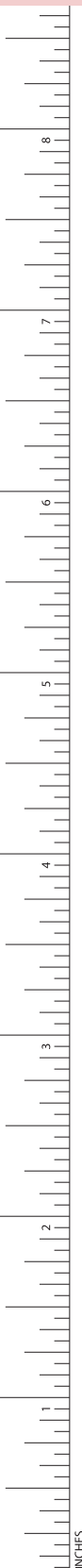

Fig. 1 Fig. 2 <sup>1/1</sup>

**ET301R ET302R**



Fig. 1 Fig. 2 Fig. 3 <sup>1/1</sup>

**ET306R ET307R ET308R**



Fig. 2 Fig. 3 <sup>1/1</sup>

**ET315R ET316R**



WINTER <sup>1/2</sup>

**ET301R-ET302R**

290 mm, 11 1/2"



WINTER <sup>1/2</sup>

**ET306R-ET308R**

290 mm, 11 1/2"



WINTER <sup>1/2</sup>

**ET315R-ET316R**

mit Sperre  
 with ratchet  
 290 mm, 11 1/2"





SAENGER  
**ET325R**  
 285 mm, 11 1/4"

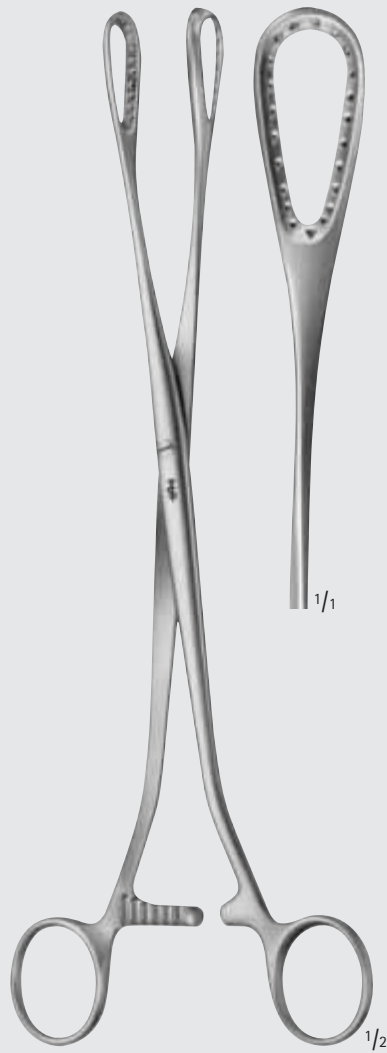

SAENGER  
**ET326R**  
 275 mm, 10 3/4"



SAENGER  
**ET327R**  
 265 mm, 10 1/2"

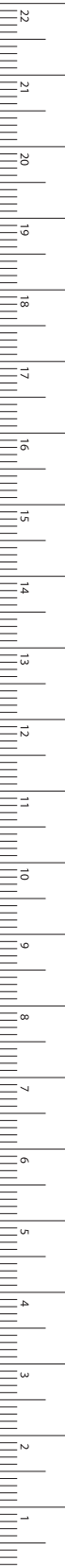

**Geburtshilfe – Obstetrics**  
Plazentar- und Abortuszangen  
Placenta- and Ovum Forceps

ET



mit Schutzklappe  
with protecting cap



AESCULAP

**ET320R**

285 mm, 11 1/4"

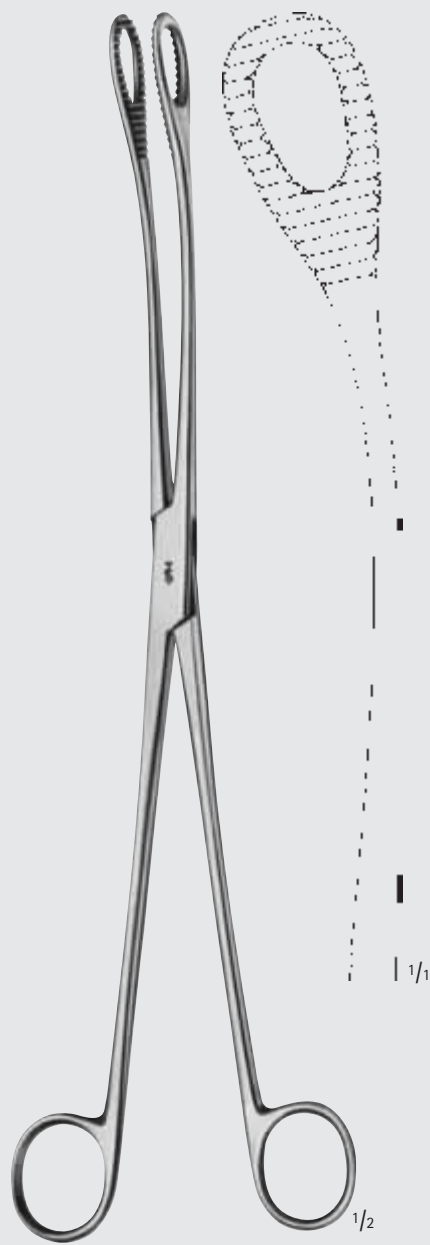

KELLY

**BF135R**

320 mm, 12 3/4"



**Geburtshilfe – Obstetrics**  
Plazentar- und Abortuszangen  
Plazenta- and Ovum Forceps

ET



MILLIMETERS

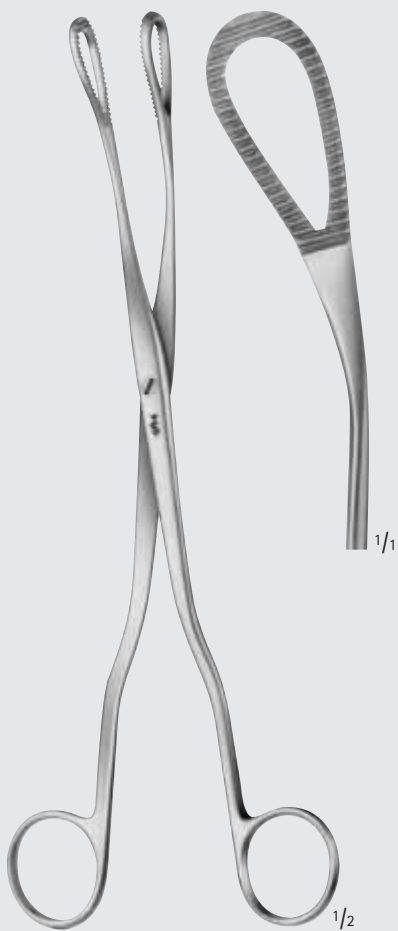

MC CLINTOCK

ET329R

240 mm, 9 1/2"



INCHES



FB



**Herz-, Thorax- und Gefäß-Chirurgie**  
Cardiovascular- and Thoracic Surgery

## Herz- und Gefäß-Chirurgie – Cardiovascular Surgery

Titan Ligaturclips und Anlegezangen

Titanium Ligating Clips and Appliers

SMALL

FB

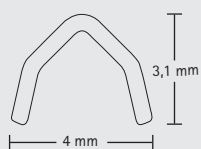

1/1

### PL565T

Titan-Ligatur-Clips  
small (gelb)

Bestelleinheit:

**PAK** = Packung à

30 Magazine = 180 Stück

Titanium ligating clips  
small (yellow)

Sales unit:

**PAK** = Package of

30 cartridges = 180 pieces

### PL566T

**Cardiopack**

Titan-Ligatur-Clips  
small (gelb)

Bestelleinheit:

**PAK** = Packung à

8 Magazine = 192 Stück

**Cardiopack**

Titanium ligating clips

small (gelb)

Sales unit:

**PAK** = Package of

8 cartridges = 192 pieces



### FB222R

Clipanlegezange  
small (gelb)

Clip applicator  
small (yellow)

150 mm, 6"



SMALL

# Herz- und Gefäß-Chirurgie – Cardiovascular Surgery

## Titan Ligaturclips und Anlegezangen

### Titanium Ligating Clips and Appliers

FB

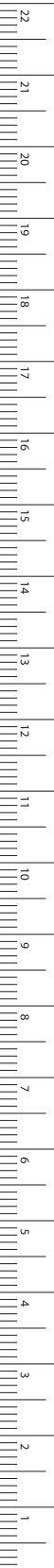

MILLIMETERS



**FB223R**  
25°

**FB226R**  
65°

**FB224R**  
25°

**FB227R**  
65°

**FB223R-FB226R**

Clipanlegezangen  
small (gelb)  
Clip appliers  
small (yellow)  
200 mm, 8"



**FB224R-FB227R**

Clipanlegezangen  
small (gelb)  
Clip appliers  
small (yellow)  
280 mm, 11"

## Herz- und Gefäß-Chirurgie – Cardiovascular Surgery

Titan Ligaturclips und Anlegezangen

Titanium Ligating Clips and Appliers

MEDIUM

FB

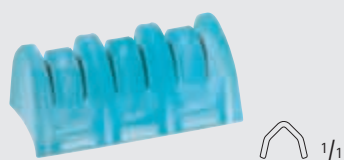
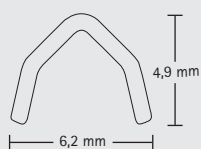

**PL567T**

Titan-Ligatur-Clips  
medium (blau)

Bestelleinheit:

**PAK** = Packung à

30 Magazine = 180 Stück

Titanium ligating clips

medium (blue)

Sales unit:

**PAK** = Package of

30 cartridges = 180 pieces



**FB234R**

Clipanlegezange  
medium (blau)

Clip applier  
medium (blue)

150 mm, 6"





MEDIUM

# Herz- und Gefäß-Chirurgie – Cardiovascular Surgery

Titan Ligaturclips und Anlegezangen  
Titanium Ligating Clips and Appliers

FB

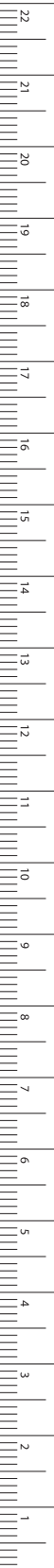

MILLIMETERS



**FB235R**  
25°

**FB238R**  
65°

**FB235R-FB238R**

Clipanlegezangen  
medium (blau)  
Clip appliers  
medium (blau)  
200 mm, 8"



**FB236R**  
25°

**FB239R**  
65°

**FB236R-FB239R**

Clipanlegezangen  
medium (blau)  
Clip appliers  
medium (bleu)  
280 mm, 11"

## Herz- und Gefäß-Chirurgie – Cardiovascular Surgery

Titan Ligaturclips und Anlegezangen

Titanium Ligating Clips and Appliers

MEDIUM-LARGE

FB

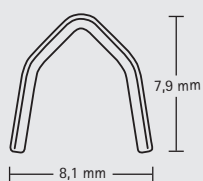

### PL568T

Titan-Ligatur-Clips  
medium-large (grün)  
Bestelleinheit:  
PAK= Packung à  
20 Magazine = 120 Stück  
Titanium ligating clips  
medium-large (green)  
Sales unit:  
PAK= Package of  
20 cartridges = 120 pieces



FB240R  
25°

FB243R  
65°

FB254R  
90°

### FB240R-FB254R

Clipanlegezangen  
medium-large (grün)  
Clip appliers  
medium-large (green)  
200 mm, 8"



MEDIUM-LARGE

## Herz- und Gefäß-Chirurgie – Cardiovascular Surgery

Titan Ligaturclips und Anlegezangen  
Titanium Ligating Clips and Appliers

FB



**FB242R**  
25°

**FB245R**  
65°

**FB255R**  
90°

**FB242R-FB255R**

Clipanlegezangen  
medium-large (grün)  
Clip appliers  
medium-large (green)  
280 mm, 11"

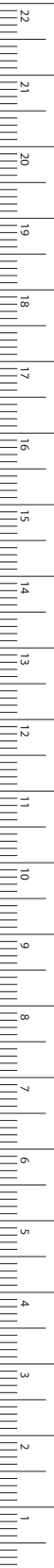

MILLIMETERS

## Herz- und Gefäß-Chirurgie – Cardiovascular Surgery

Titan Ligaturclips und Anlegezangen

Titanium Ligating Clips and Appliers

LARGE

FB

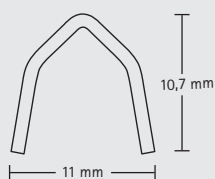

**PL561T**

Titan-Ligatur-Clips  
large (orange)

Bestelleinheit:

PAK = Packung à

20 Magazine = 120 Stück

Titanium ligating clips

large (orange)

Sales unit:

PAK = Package of

20 cartridges = 120 pieces



**FB246R**

25°

**FB249R**

65°

**FB252R**

90°

**FB246R-FB252R**

Clipanlegezangen

large (orange)

Clip appliers

large (orange)

200 mm, 8"



LARGE

## Herz- und Gefäß-Chirurgie – Cardiovascular Surgery

Titan Ligaturclips und Anlegezangen  
Titanium Ligating Clips and Appliers

FB

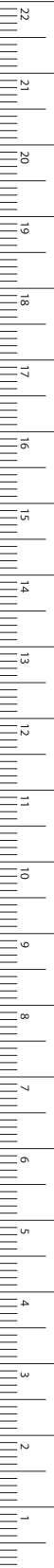

MILLIMETERS



**FB248R**

25°

**FB251R**

65°

**FB253R**

90°

**FB248R-FB253R**

Clipanlegezangen  
large (orange)

Clip appliers  
large (orange)

280 mm, 11"

## Herz- und Gefäß-Chirurgie – Cardiovascular Surgery

Mikro-Federschere mit Flachgriff

Micro Scissors with Flat Handle

FB



165 mm, 6 1/2"

1/1



## Herz- und Gefäß-Chirurgie – Cardiovascular Surgery

### Mikro-Federscheren mit Flachgriff

### Micro Scissors with Flat Handle

25°



**FM470R**

45°



**FM471R**

60°



**FM472R**

90°



**FM473R**

125°



**FM474R**

1/1

gerade  
straight

aufgebogen  
curved  
on flat

Feines Blatt  
Fine blade



**FM451R**



**FM452R**



**FM453R**



**FM454R**



**FM455R**

1/1

Feines Blatt,  
1 Blatt mit Knopf  
Fine blade,  
with 1 probe  
pointed blade



**FM437R**



**FM438R**



**FM439R**



**FM440R**



**FM441R**



**FM442R**



**FM436R**

1/1

Sehr feines Blatt  
Delicate blade



**FM431R**



**FM432R**



**FM433R**



**FM434R**



**FM435R**



**FM444R**



**FM430R**

1/1

Extrem feines Blatt  
Ultra delicate blade

**FB**

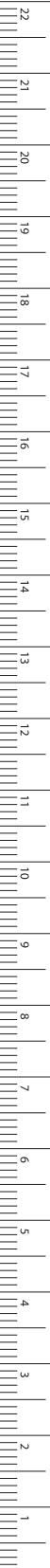

MILLIMETERS

## Herz- und Gefäß-Chirurgie – Cardiovascular Surgery

Mikro-Federscheren mit Rundgriff

Micro Scissors (Spring Type) with Round Handle

FB



1/1

165 mm, 6 1/2"





# Herz- und Gefäß-Chirurgie – Cardiovascular Surgery

## Mikro-Federscheren mit Rundgriff

### Micro Scissors with Round Handle

25°



**FM476R**

45°



**FM477R**

60°



**FM478R**

90°



**FM479R**

125°



**FM480R**

gerade  
straight

aufgebogen  
curved  
on flat

Feines Blatt  
Fine blade



**FM482R**



**FM483R**



**FM484R**



**FM485R**



**FM486R**



**FM488R**



**FM481R**

Sehr feines Blatt  
Delicate blade



**FM489R**



**FM490R**



**FM491R**



**FM492R**



**FM493R**

Sehr feines Blatt,  
1 Blatt mit Knopf  
Delicate blade,  
with 1 probe  
pointed blade



**FM504R**



**FM505R**



**FM506R**



**FM507R**



**FM508R**



**FM503R**

Extrem feines Blatt  
Ultra delicate blade

**FB**

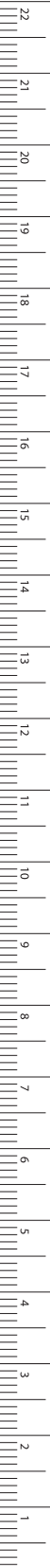

MILLIMETERS

**Herz- und Gefäß-Chirurgie – Cardiovascular Surgery**

Mikro-Gefäßscheren

Micro Vascular Scissors

**FB**



1/1

**DIETHRICH-POTTS**  
180 mm, 7"



# Herz- und Gefäß-Chirurgie – Cardiovascular Surgery

Mikro-Gefäßscheren  
Micro Vascular Scissors

FB

25°



BC522R

45°

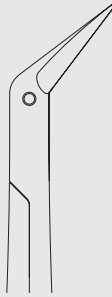

BC523R

60°

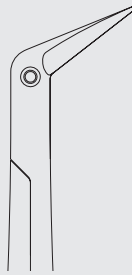

BC524R

90°

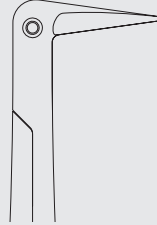

BC525R

125°

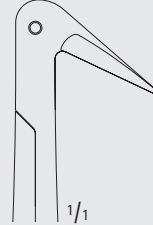

BC526R

Standard Blatt  
Standard blade



BC531R

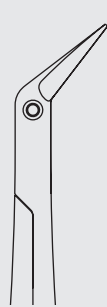

BC532R

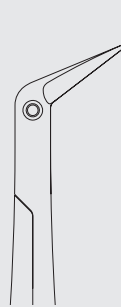

BC533R

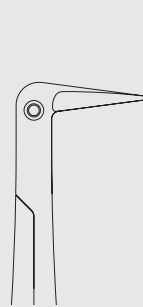

BC534R

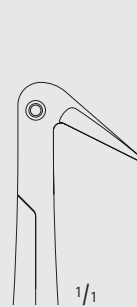

BC535R

Sehr feines Blatt  
Delicate blade



BC515R

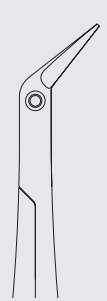

BC516R

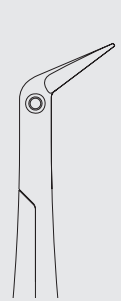

BC517R

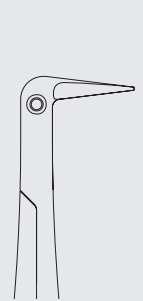

BC518R

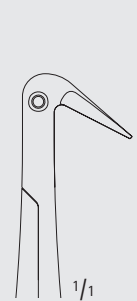

BC519R

Extrem feines Blatt  
Ultra delicate blade

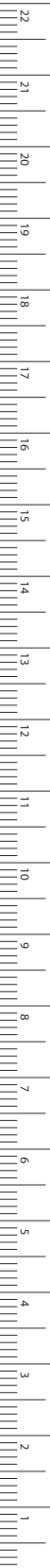

MILLIMETERS

## Herz- und Gefäß-Chirurgie – Cardiovascular Surgery

Mikro-Pinzetten mit Rundgriff und Gewicht

Micro Forceps with Round Handles and Counter Balance

FB

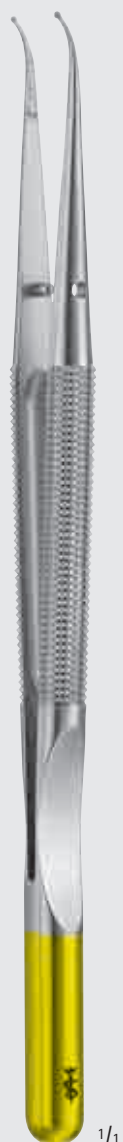

150 mm, 6"  $\frac{1}{1}$

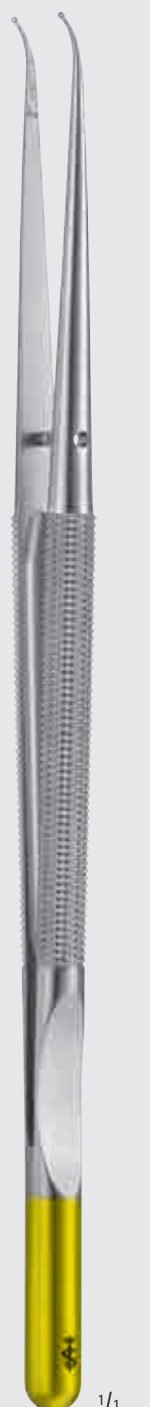

185 mm, 7  $\frac{1}{4}$ "  $\frac{1}{1}$

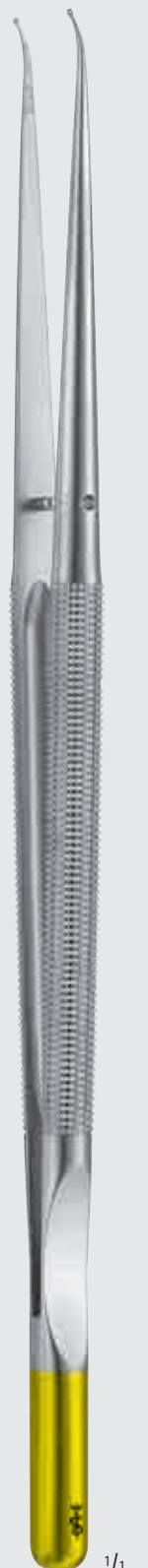

210 mm, 8  $\frac{1}{4}$ "  $\frac{1}{1}$

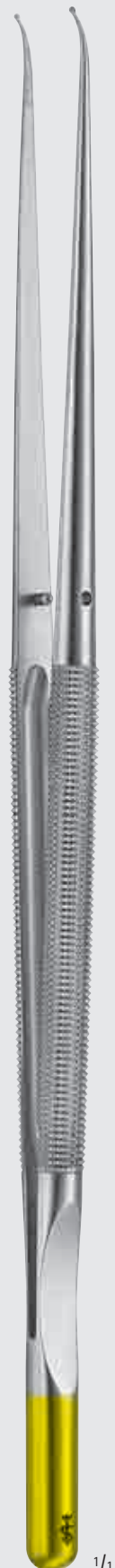

230 mm, 9"  $\frac{1}{1}$



250 mm, 10"  $\frac{1}{1}$



## Herz- und Gefäß-Chirurgie – Cardiovascular Surgery

### Mikro-Pinzetten mit Rundgriff und Gewicht

#### Micro Forceps with Round Handles and Counter Balance

FB



MILLIMETERS

DIADUST



Die Diamantstaubbeschichtung sorgt für eine noch härtere und verschleißfestere Maulinnenfläche. Darüber hinaus garantiert die Struktur der DIADUST-Beschichtung ein zuverlässiges Fassen von feinen Nadeln und Nahtmaterialien sowie von Weichgewebe.

The diamond dust coating ensures an even harder and more wear resistant surface on the inside of the jaws. Moreover, the structure of the DIADUST coating guarantees a reliable grip for fine needles and sutures, as well as for tissue.

Maulform  
Jaw

Ring-Ø: 1 mm, gerade diam. of ring: 1 mm, straight	Ring-Ø: 1 mm, gebogen diam. of ring: 1 mm, curved	Ring-Ø: 2 mm, gerade diam. of ring: 2 mm, straight	Fadenplatte, gerade Platform tips, straight	Fadenplatte, gebogen Platform tips, curved	1 mm, DeBakey Zahnung 1 mm, DeBakey tip
---	--	---	--	---	---



1/1

Länge (mm)  
Length (in.)

150 mm 6"	<a href="#">FM570R</a>	<a href="#">FM571R</a>		<a href="#">FM578R</a>	<a href="#">FM581R</a>	
185 mm 7 1/4"	<a href="#">FM572R</a>	<a href="#">FM573R</a>	<a href="#">FM579R</a>	<a href="#">FM580R</a>	<a href="#">FM583R</a>	<a href="#">FM592R</a>
210 mm 8 1/4"	<a href="#">FM574R</a>	<a href="#">FM575R</a>		<a href="#">FM599R</a>	<a href="#">FM585R</a>	<a href="#">FM600R</a>
230 mm 9"	<a href="#">FM576R</a>	<a href="#">FM577R</a>				
250 mm 10"	<a href="#">FM596R</a>	<a href="#">FM595R</a>		<a href="#">FM594R</a>	<a href="#">FM593R</a>	

## Herz- und Gefäß-Chirurgie – Cardiovascular Surgery

Mikro-Pinzetten mit Rundgriff, ohne Gewicht

Micro Forceps with Round Handles, without Counter Balance

DIADUST

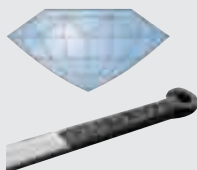

Die Diamantstaubbeschichtung sorgt für eine noch härtere und verschleißfestere Maulinnenfläche. Darüber hinaus garantiert die Struktur der DIADUST-Beschichtung ein zuverlässiges Fassen von feinen Nadeln und Nahtmaterialien sowie von Weichgewebe.

The diamond dust coating ensures an even harder and more wear resistant surface on the inside of the jaws. Moreover, the structure of the DIADUST coating guarantees a reliable grip for fine needles and sutures, as well as for tissue.



185 mm, 7 1/4"

210 mm, 8 1/4"

FB





## Herz- und Gefäß-Chirurgie – Cardiovascular Surgery

### Mikro-Pinzetten mit Rundgriff, ohne Gewicht

#### Micro Forceps with Round Handles, without Counter Balance

Maulform Jaw	Ring-Ø: 1 mm, gerade diam. of ring: 1 mm, straight	Ring-Ø: 1 mm, gebogen diam. of ring: 1 mm, curved	Ring-Ø: 1 mm mit Fadenplatte diam. of ring: 1 mm with platform tip	Fadenplatte, gerade Platform tip, straight	1 mm, DeBakey Zahnung 1 mm, DeBakey tip
Länge (mm) Length (in.)					
185 mm 7 1/4"	<b>FM597R</b>	<b>FM587R</b>	<b>FM582R</b>	<b>FM586R</b>	<b>FM590R</b>
210 mm 8 1/4"	<b>FM598R</b>	<b>FM589R</b>	<b>FM584R</b>	<b>FM588R</b>	<b>FM591R</b>

1/1  
Karoprofil  
cross serrated

1/2

**FM063R**

Rundgriff  
round handle  
200 mm, 8"

DIADUST

**FM053R**

Ring-Ø: 2,5 mm  
diam. of ring: 2.5 mm

180 mm  
7"

1/1

**FM054R**

Ring-Ø: 2,5 mm  
diam. of ring: 2.5 mm

200 mm  
8"

**FM053R-FM054R**

Rundgriff  
round handle

FB

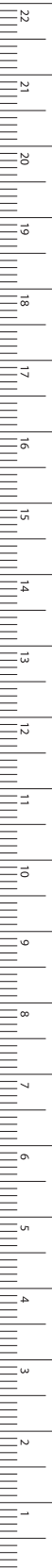

MILLIMETERS

## Herz- und Gefäß-Chirurgie – Cardiovascular Surgery

Mikro-Pinzetten mit Flachgriff

Micro Forceps with Flat Handle

FB



180 mm, 7"  $\frac{1}{1}$



200 mm, 8"  $\frac{1}{1}$



250 mm, 10"  $\frac{1}{1}$





## Herz- und Gefäß-Chirurgie – Cardiovascular Surgery

### Mikro-Pinzetten mit Flachgriff Micro Forceps with Flat Handle

FB

DIADUST



Die Diamantstaubbeschichtung sorgt für eine noch härtere und verschleißfestere Maulinnenfläche. Darüber hinaus garantiert die Struktur der DIADUST-Beschichtung ein zuverlässiges Fassen von feinen Nadeln und Nahtmaterialien sowie von Weichgewebe.

The diamond dust coating ensures an even harder and more wear resistant surface on the inside of the jaws. Moreover, the structure of the DIADUST coating guarantees a reliable grip for fine needles and sutures, as well as for tissue.

Maulform  
Jaw

1 mm,  
Karoprofil

1 mm,  
cross serrated



1 mm,  
DeBakey  
Zahnung

1 mm,  
DeBakey tip



Ring-Ø:  
1 mm,  
gerade

diam. of ring:  
1 mm,  
straight



Ring-Ø:  
1 mm,  
gebogen

diam. of ring:  
1 mm,  
curved



1 mm,  
gerade

1 mm,  
straight



Länge (mm)  
Length (in.)

180 mm  
7"

**BD190R**

**BD191R**

**BD192R**

**BD193R**

**BD194R**

200 mm  
8"

**BD195R**

**BD196R**

250 mm  
10"

**BD197R**

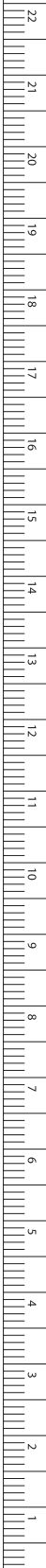

MILLIMETERS

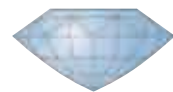

## Herz- und Gefäß-Chirurgie – Cardiovascular Surgery

DIADUST Mikro-Nadelhalter mit Rundgriff

DIADUST Micro Needle Holders with Round Handle

DIADUST



Die Diamantstaubbeschichtung sorgt für eine noch härtere und verschleißfestere Maulinnenfläche. Darüber hinaus garantiert die Struktur der DIADUST-Beschichtung ein zuverlässiges Fassen von feinen Nadeln und Nahtmaterialien sowie von Weichgewebe.

The diamond dust coating ensures an even harder and more wear resistant surface on the inside of the jaws. Moreover, the structure of the DIADUST coating guarantees a reliable grip for fine needles and sutures, as well as for tissue.

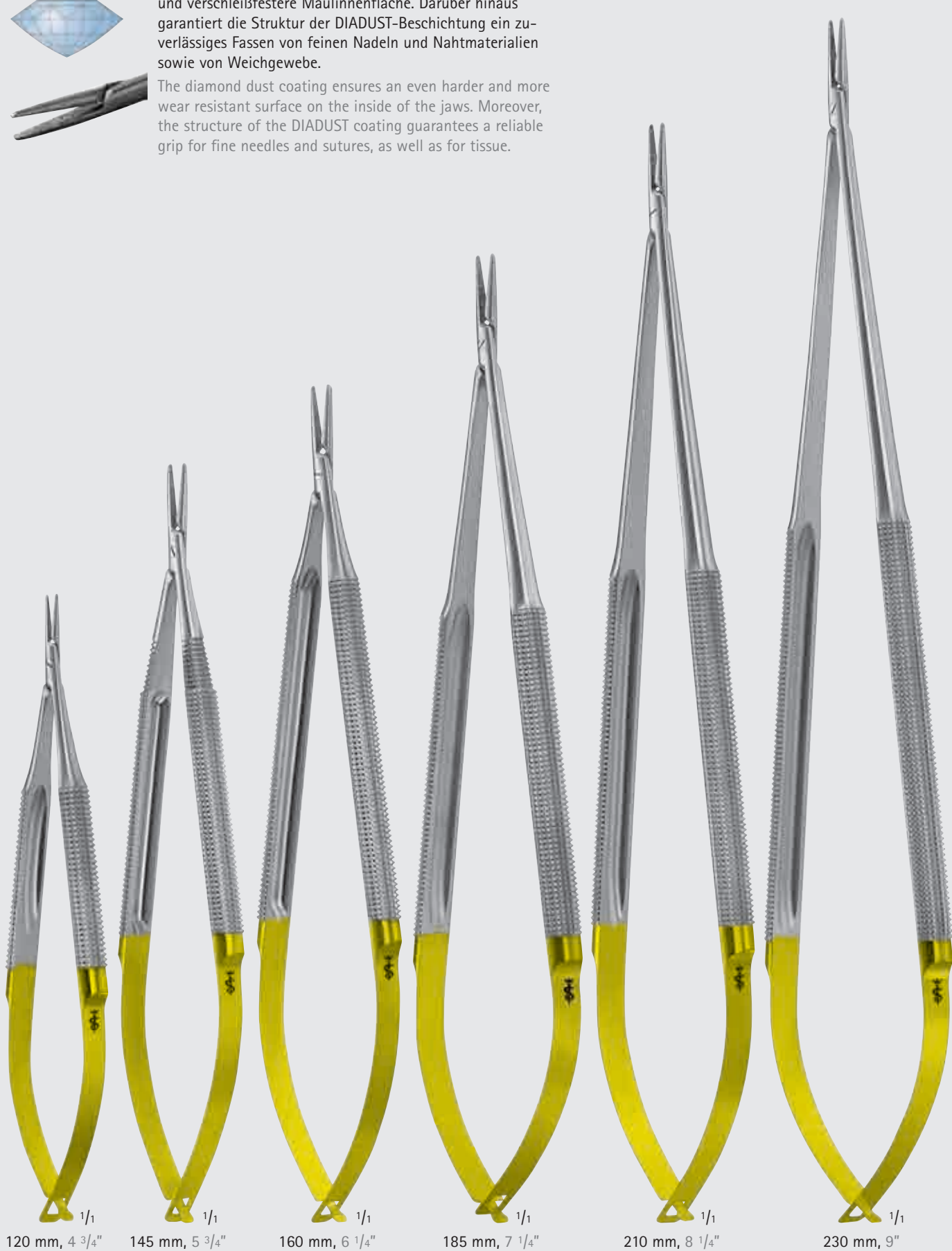

120 mm, 4 <sup>3</sup>/<sub>4</sub>"

145 mm, 5 <sup>3</sup>/<sub>4</sub>"

160 mm, 6 <sup>1</sup>/<sub>4</sub>"

185 mm, 7 <sup>1</sup>/<sub>4</sub>"

210 mm, 8 <sup>1</sup>/<sub>4</sub>"

230 mm, 9"

1/1

1/1

1/1

1/1

1/1

1/1



DIADUST



## Herz- und Gefäß-Chirurgie – Cardiovascular Surgery

### DIADUST Mikro-Nadelhalter mit Rundgriff

### DIADUST Micro Needle Holders with Round Handle

FB

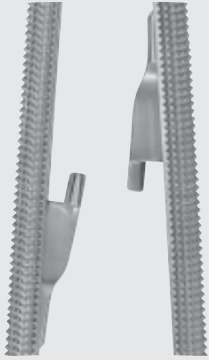

mit Sperre  
with ratchet



Nahtmaterialgröße  
Suture size

Länge (mm) Length (in.)	7/0 und kleiner 7/0 and smaller	5/0 und kleiner 5/0 and smaller	4/0 und kleiner 4/0 and smaller	4/0 und kleiner 4/0 and smaller
120 mm 4 3/4"	<b>FM520R</b>			
145 mm 5 3/4"		<b>FM522R</b>		
160 mm 6 1/4"	<b>FM521R</b>	<b>FM523R</b>		
185 mm 7 1/4"	<b>FM563R</b>	<b>FM564R</b>	<b>FM218R</b>	
210 mm 8 1/4"	<b>FM565R</b>	<b>FM566R</b>	<b>FM228R</b>	<b>FM221R</b>
230 mm 9"	<b>FM567R</b>	<b>FM568R</b>	<b>FM230R</b>	<b>FM223R</b>

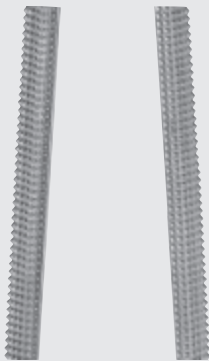

ohne Sperre  
without  
ratchet



Nahtmaterialgröße  
Suture size

Länge (mm) Length (in.)	7/0 und kleiner 7/0 and smaller	5/0 und kleiner 5/0 and smaller
120 mm 4 3/4"	<b>FM524R</b>	
145 mm 5 3/4"		<b>FM528R</b>
160 mm 6 1/4"	<b>FM525R</b>	<b>FM529R</b>
185 mm 7 1/4"	<b>FM526R</b>	<b>FM530R</b>
210 mm 8 1/4"	<b>FM527R</b>	<b>FM531R</b>
230 mm 9"	<b>FM532R</b>	<b>FM533R</b>



MILLIMETERS

## Herz- und Gefäß-Chirurgie – Cardiovascular Surgery

### DIADUST Mikro-Nadelhalter mit Rundgriff

#### DIADUST Micro Needle Holders with Round Handle

##### DIADUST



Die Diamantstaubbeschichtung sorgt für eine noch härtere und verschleißfestere Maulinnenfläche. Darüber hinaus garantiert die Struktur der DIADUST-Beschichtung ein zuverlässiges Fassen von feinen Nadeln und Nahtmaterialien sowie von Weichgewebe.

The diamond dust coating ensures an even harder and more wear resistant surface on the inside of the jaws. Moreover, the structure of the DIADUST coating guarantees a reliable grip for fine needles and sutures, as well as for tissue.



190 mm, 7 1/2"

230 mm, 9"

250 mm, 10"





DIADUST



## Herz- und Gefäß-Chirurgie – Cardiovascular Surgery

DIADUST Mikro-Nadelhalter mit Rundgriff

DIADUST Micro Needle Holders with Round Handle

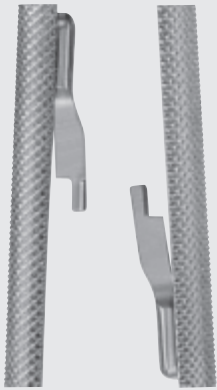

mit Sperre,  
kräftige  
Ausführung  
with ratchet,  
heavy style

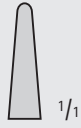

Nahtmaterialgröße  
Suture size

Länge (mm)  
Length (in.)

190 mm  
7 1/2"

**FM538R**

230 mm  
9"

**FM539R**

250 mm  
10"

**FM534R**

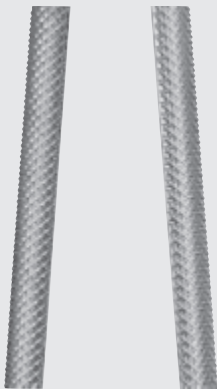

ohne Sperre,  
kräftige  
Ausführung  
without  
ratchet,  
heavy style



Nahtmaterialgröße  
Suture size

Länge (mm)  
Length (in.)

190 mm  
7 1/2"

**FM535R**

230 mm  
9"

**FM536R**

250 mm  
10"

**FM537R**

FB

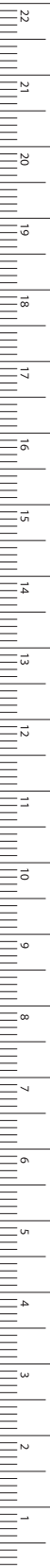

MILLIMETERS

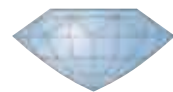

## Herz- und Gefäß-Chirurgie – Cardiovascular Surgery

DIADUST Mikro-Nadelhalter mit Flachgriff

DIADUST Micro Needle Holders with Flat Handles

DIADUST



Die Diamantstaubbeschichtung sorgt für eine noch härtere und verschleißfestere Maulinnenfläche. Darüber hinaus garantiert die Struktur der DIADUST-Beschichtung ein zuverlässiges Fassen von feinen Nadeln und Nahtmaterialien sowie von Weichgewebe.

The diamond dust coating ensures an even harder and more wear resistant surface on the inside of the jaws. Moreover, the structure of the DIADUST coating guarantees a reliable grip for fine needles and sutures, as well as for tissue.



145 mm, 5 <sup>3</sup>/<sub>4</sub>"

170 mm, 6 <sup>3</sup>/<sub>4</sub>"

185 mm, 7 <sup>1</sup>/<sub>4</sub>"

210 mm, 8 <sup>1</sup>/<sub>4</sub>"

230 mm, 9"



DIADUST



## Herz- und Gefäß-Chirurgie – Cardiovascular Surgery

DIADUST Mikro-Nadelhalter mit Flachgriff

DIADUST Micro Needle Holders with Flat Handles

FB

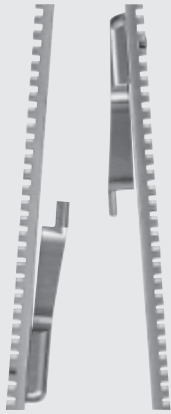

mit Sperre  
with ratchet



Nahtmaterialgröße  
Suture size

Länge (mm) Length (in.)	7/0 und kleiner 7/0 and smaller	5/0 und kleiner 5/0 and smaller
145 mm 5 3/4"		<b>FM541R</b>
170 mm 6 3/4"	<b>FM540R</b>	
185 mm 7 1/4"		<b>FM542R</b>
210 mm 8 1/4"		<b>FM543R</b>
230 mm 9"		<b>FM544R</b>

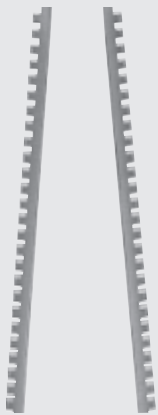

ohne Sperre  
without  
ratchet



Nahtmaterialgröße  
Suture size

Länge (mm) Length (in.)	7/0 und kleiner 7/0 and smaller	5/0 und kleiner 5/0 and smaller
145 mm 5 3/4"		<b>FM546R</b>
170 mm 6 3/4"	<b>FM545R</b>	
185 mm 7 1/4"		<b>FM547R</b>
210 mm 8 1/4"		<b>FM548R</b>
230 mm 9"		<b>FM549R</b>

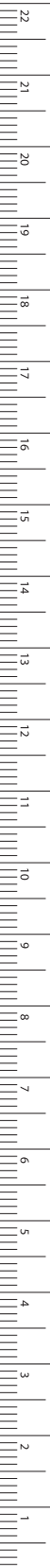

MILLIMETERS

## Herz- und Gefäß-Chirurgie – Cardiovascular Surgery

DIADUST Mikro-Nadelhalter mit Flachgriff

DIADUST Micro Needle Holder with Flat Knurled Handle

DIADUST

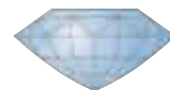

DIADUST



Die Diamantstaubbeschichtung sorgt für eine noch härtere und verschleißfestere Maulinnenfläche. Darüber hinaus garantiert die Struktur der DIADUST-Beschichtung ein zuverlässiges Fassen von feinen Nadeln und Nahtmaterialien sowie von Weichgewebe.

The diamond dust coating ensures an even harder and more wear resistant surface on the inside of the jaws. Moreover, the structure of the DIADUST coating guarantees a reliable grip for fine needles and sutures, as well as for tissue.



185 mm, 7  $\frac{1}{4}$ "

210 mm, 8  $\frac{1}{4}$ "

230 mm, 9"

FB







DIADUST



## Herz- und Gefäß-Chirurgie – Cardiovascular Surgery

DIADUST Mikro-Nadelhalter mit Flachgriff

DIADUST Micro Needle Holders with Flat Knurled Handle



mit Sperre  
with ratchet



Nahtmaterialgröße  
Suture size

Länge (mm)  
Length (in.)

5/0 und kleiner  
5/0 and smaller

185 mm  
7 1/4"

**FM550R**

210 mm  
8 1/4"

**FM551R**

230 mm  
9"

**FM552R**



ohne Sperre  
without  
ratchet



Nahtmaterialgröße  
Suture size

Länge (mm)  
Length (in.)

5/0 und kleiner  
5/0 and smaller

185 mm  
7 1/4"

**FM553R**

210 mm  
8 1/4"

**FM554R**

230 mm  
9"

**FM555R**

FB

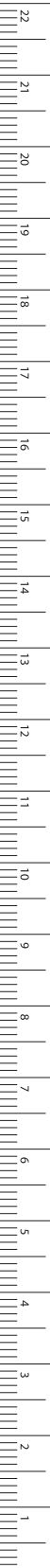

MILLIMETERS

## Herz- und Gefäß-Chirurgie – Cardiovascular Surgery

DIADUST Mikro-Nadelhalter

DIADUST Micro Needle Holders

DIADUST



DIADUST



Die Diamantstaubbeschichtung sorgt für eine noch härtere und verschleißfestere Maulinnenfläche. Darüber hinaus garantiert die Struktur der DIADUST-Beschichtung ein zuverlässiges Fassen von feinen Nadeln und Nahtmaterialien sowie von Weichgewebe.

The diamond dust coating ensures an even harder and more wear resistant surface on the inside of the jaws. Moreover, the structure of the DIADUST coating guarantees a reliable grip for fine needles and sutures, as well as for tissue.



GLASSER

**FM560R**

Nahtmaterialgröße: 5/0 und kleiner  
Suture size: 5/0 and smaller  
125 mm, 5"

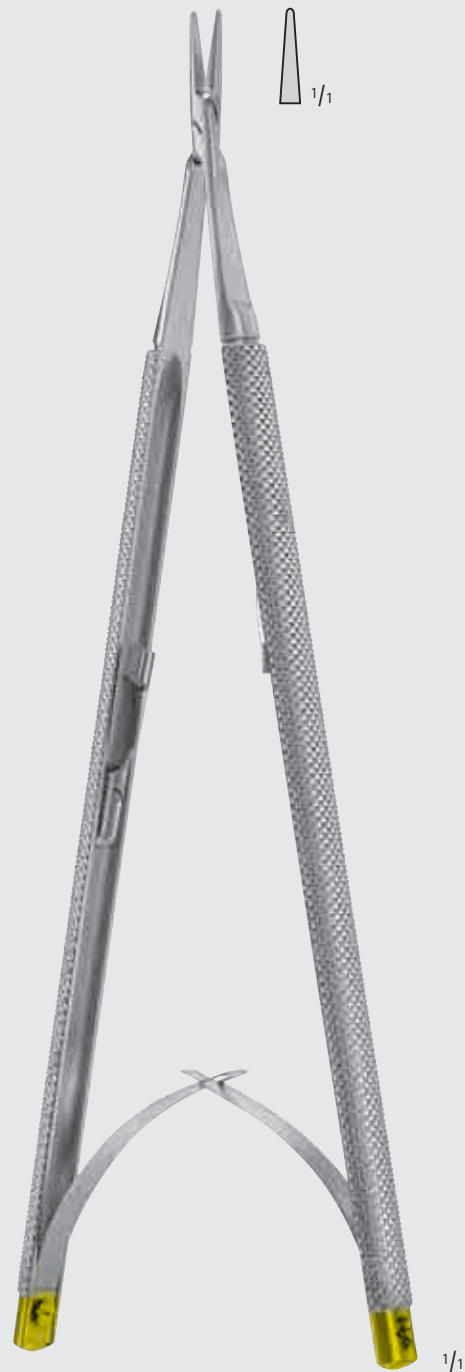

GLASSER

**FM561R**

Nahtmaterialgröße: 5/0 und kleiner  
Suture size: 5/0 and smaller  
180 mm, 7"



DIADUST



# Herz- und Gefäß-Chirurgie – Cardiovascular Surgery

DIADUST Mikro-Nadelhalter

DIADUST Micro Needle Holders

FB



**FM236R**  
mit Sperre  
Nahtmaterialgröße: 5/0 und kleiner  
with ratchet  
Suture size: 5/0 and smaller  
210 mm, 8 1/4"  
1/2



**FM276R**  
ohne Sperre  
Nahtmaterialgröße: 5/0 und kleiner  
without ratchet  
Suture size: 5/0 and smaller  
210 mm, 8 1/4"  
1/2



BM301R	BM325R	BM302R	BM327R	BM328R
140 mm	160 mm	180 mm	220 mm	250 mm
5 1/2"	6 1/4"	7"	8 3/4"	10"

**RYDER**  
**BM301R-BM328R**  
Nahtmaterialgröße: 5/0 und kleiner  
Suture Size: 5/0 and smaller



MILLIMETERS

## Herz- und Gefäß-Chirurgie – Cardiovascular Surgery

Spezialinstrumentarium für die Anlage von AV-Shunts bei Dialysepatienten

Instruments for Shunt Operations

Die Shunt Instrumente wurden speziell für Operationen an Gefäßen mit einem Durchmesser zwischen 4 und 6 mm entwickelt.

Besonders häufig tritt dieser Gefäßdurchmesser bei der Anlage oder Revision Dialyseshunt auf. Bei den vorliegenden Instrumenten handelt es sich um eine Synthese von konventionellen Instrumenten und Mikroinstrumenten. Die Arbeitsenden wurden entsprechend dem Gefäßdurchmesser etwas größer gewählt, das Griffdesign entspricht einem Mikroinstrument um eine bessere Handhabung zu ermöglichen.

The shunt instruments were developed especially for operations on vessels that are between 4 and 6 mm in diameter.

This width is frequently found in dialysis shunt operations and re-operations. These instruments combine the features of conventional instruments and micro instruments. The working tips are larger than usual for instruments of this type, and the micro instrument style handles make the instruments better to use.

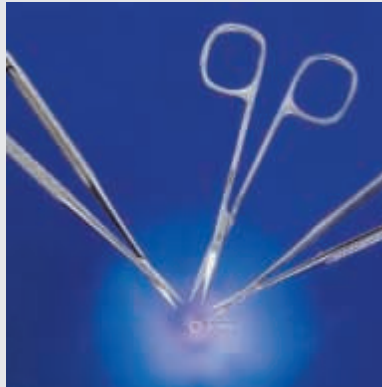

Entwickelt in Zusammenarbeit mit Prof. Dr. med. Gottfried Müller Caritas Krankenhaus Bad Mergentheim Uhlandstrasse 7 97980 Bad Mergentheim

The shunt set was developed in cooperation with Prof. Dr. med. Gottfried Müller, M.D. Caritas Krankenhaus Bad Mergentheim Uhlandstrasse 7 97980 Bad Mergentheim

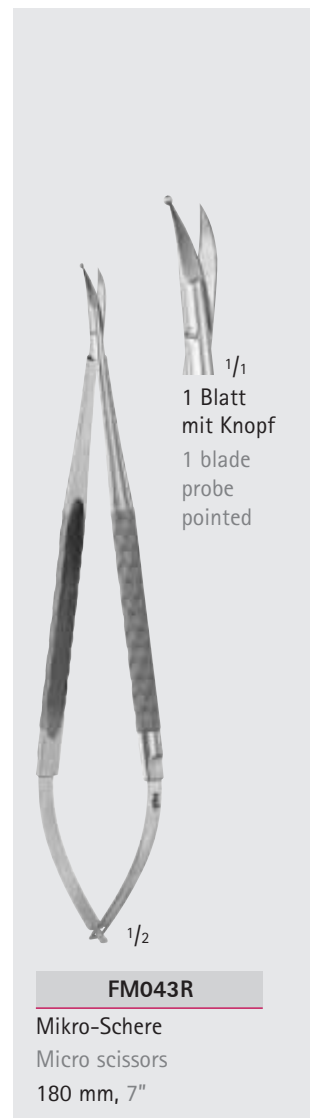
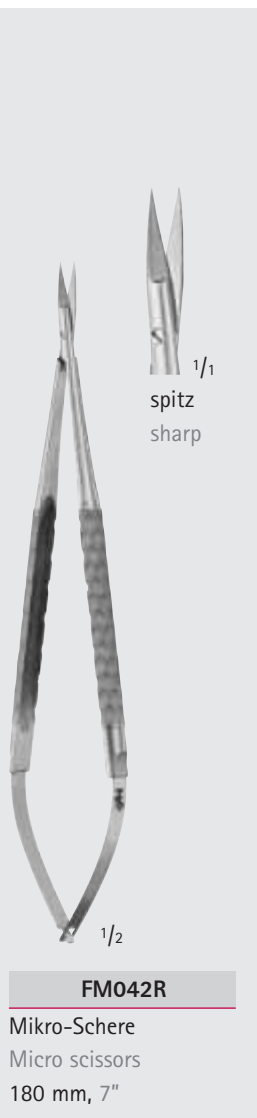



FB





## Herz- und Gefäß-Chirurgie – Cardiovascular Surgery



### Spezialinstrumentarium für die Anlage von AV-Shunts bei Dialysepatienten Instruments for Shunt Operations

1/1  
Ring-Ø: 2 mm  
diam. of ring: 2 mm

**FM047R**  
Mikro-Ringpinzette  
Micro ring forceps  
180 mm, 7"

1/2





DIADUST

1/1  
Ring-Ø: 1 mm  
diam. of ring: 1 mm

**FM572R**  
Mikro-Ringpinzette  
Micro ring forceps  
185 mm, 7 1/4"

1/2



DIADUST

2/1

**FD255R**  
Chirurgische Mikro-Pinzette  
Micro tissue forceps  
180 mm, 7"

1/2







DIADUST

1/1  
mit Plateau  
with platform tip

**FD253R**  
Anatomische Mikro-Pinzette  
Micro dissecting forceps  
180 mm, 7"

1/2

DIADUST

**FD258R**    **FD259R**

1/1

**FD258R-FD259R**  
Mikro-Nadelhalter  
Micro needle holders  
180 mm, 7"

1/2

FB

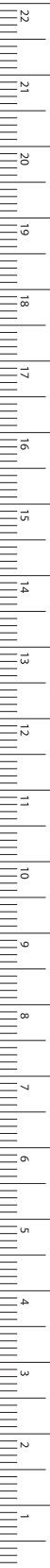

MILLIMETERS

# Herz- und Gefäß-Chirurgie – Cardiovascular Surgery

## Mikro-Nadelhalter mit Flachgriff

### Micro Needle Holders with Flat Handles

FB

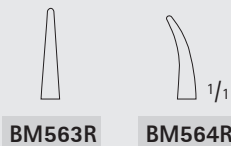

**BM563R**

**BM564R**

CASTROVIEJO

**BM563R-BM564R**

mit Sperre  
with catch

145 mm, 5 3/4"



**FD076R**

**FD079R**

**FD076R-FD079R**

ohne Sperre  
without catch

160 mm, 6 1/4"



**FD080R**

**FD081R**

**FD080R-FD081R**

ohne Sperre  
without catch

185 mm, 7 1/4"



**FD045R**

**FD046R**

ohne Sperre  
without catch

mit Sperre  
with catch

JACOBSON

**FD045R-FD046R**

185 mm, 7 1/4"



**FD048R**

mit Sperre  
with catch

200 mm, 8"



## Herz- und Gefäß-Chirurgie – Cardiovascular Surgery

### Mikro-Nadelhalter mit Rundgriffen

### Micro Needle Holders with Round Handles

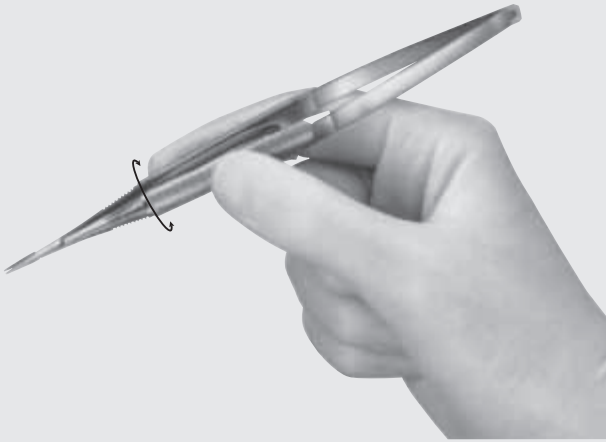

#### ... mit Rundgriffen

- Rundgriffe erlauben Drehbewegungen zwischen den Fingern.
- Optimale Balance, individuell je nach Instrument, durch volle oder gehöhlte Griffpartien.

#### ... with round handles

- Round handles allow turning manipulations between the fingers.
- Optimum balance individually for each instrument due to solid or hollowed-out handles.

FB

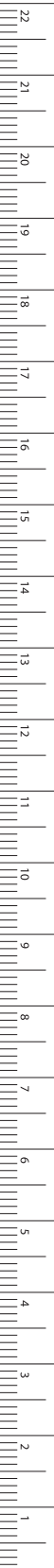

MM/MILLIMETERS



BARRAQUER

**BM560R-BM562R**

ohne Sperre  
without catch

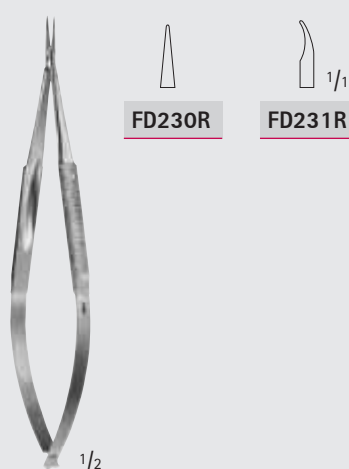

BARRAQUER

**FD230R-FD231R**

ohne Sperre  
without catch  
120 mm, 4 3/4"

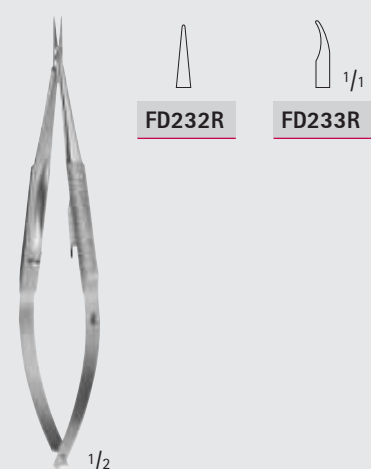

BARRAQUER

**FD232R-FD233R**

mit Sperre  
with catch  
120 mm, 4 3/4"

## Herz- und Gefäß-Chirurgie – Cardiovascular Surgery

Mikro-Nadelhalter mit Rundgriffen

Micro Needle Holders with Round Handles

FB



FD240R

FD241R

1/2

REILL

FD240R-FD241R

ohne Sperre  
without catch  
150 mm, 6"

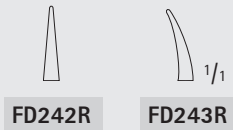

FD242R

FD243R

1/2

FD242R-FD243R

mit Sperre  
with catch  
150 mm, 6"

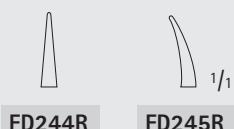

FD244R

FD245R

1/2

FD244R-FD245R

ohne Sperre  
without catch  
185 mm, 7 1/4"

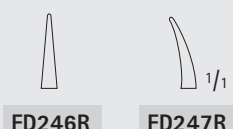

FD246R

FD247R

1/2

FD246R-FD247R

mit Sperre  
with catch  
185 mm, 7 1/4"



FM398R

FM392R

ohne Sperre  
without catch

mit Sperre  
with catch

1/2

FM398R-FM392R





# Herz- und Gefäß-Chirurgie – Cardiovascular Surgery

## DUROGRIP® Mikro-Nadelhalter

### DUROGRIP® Micro Needle Holders

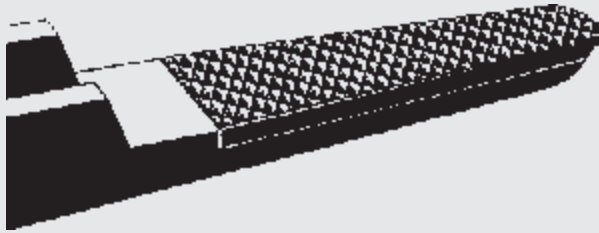
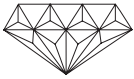

AESCULAP-Nadelhalter sind durch die Struktur der Hartmetall-Maulteile auf das jeweilige, indikationsbezogene Nahtmaterial abgestimmt. Eine glatte Maulfläche sowie 3 verschiedene Haftprofile garantieren den sicheren „Griff“ der jeweiligen Nadel.

AESCULAP needle holders have jaws with carbide inserts and according to the use required the resp. structure can be chosen. A smooth jaw surface as well as 3 different serrations guarantee a sure „grip“ of the resp. needle.



glatt  
smooth



0,2



0,4



0,5

Wir empfehlen Hartmetall-Maulteile mit glatter Fläche für Nahtmaterial mit Teilung 0,2 mm für Nahtmaterial 0,4 mm 0,5 mm

9/0 – 11/0  
6/0 – 10/0  
4/0 – 6/0  
bis 3/0

We recommend carbide inserts with smooth jaw surface for suture material with 0.2 mm pitch of serration for suture material 0.4 mm 0.5 mm

9/0 – 11/0  
6/0 – 10/0  
4/0 – 6/0  
up to 3/0



#### DUROGRIP®-Nadelhalter mit Hartmetall-Plättchen

##### Kennzeichnung:

##### Vergoldete Ringe, Branchenenden und Sperren

##### DUROGRIP® Needle Holders with carbide inserts

##### Identification:

##### gold-plated rings, handle ends and ratchets



1/1  
mit glattem Maul  
with smooth jaw

1/2

CASTROVIEJO

**BM001R**

145 mm, 5 3/4"



1/1  
0,2

1/2

CASTROVIEJO

**BM002R**

145 mm, 5 3/4"



1/1  
0,4

1/2

**BM003R**

170 mm, 6 3/4"

FB

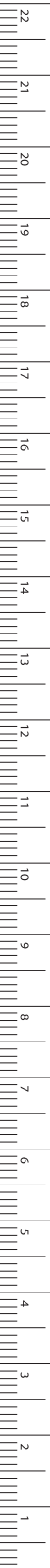

MILLIMETERS

# Herz- und Gefäß-Chirurgie – Cardiovascular Surgery

DUROGRIP® Mikro-Nadelhalter

DUROGRIP® Micro Needle Holders

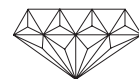

FB



CASTROVIEJO

**BM004R**

180 mm, 7"



CASTROVIEJO

**BM005R**

215 mm, 8 1/2"



**FM388R**

mit Sperre  
with catch  
180 mm, 7"



**FM390R**

mit Sperre  
with catch  
200 mm, 8"

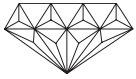

## Herz- und Gefäß-Chirurgie – Cardiovascular Surgery

DUROGRIP® Nadelhalter, ergonomische Griff-Form  
DUROGRIP® Nadelhalter, Ergonomic Handle

Diese Instrumente bieten dem Chirurgen ein Maximum an ergonomischem Komfort. Das optimierte Design der Instrumente ermöglicht ein ermüdungsfreies Arbeiten insbesondere bei schwierigen Naht- und Anastomostechiken.

These instruments provide the surgeon with a maximum of ergonomical comfort. The optimized design of the Instruments offers a fatigue-free working especially with regard to difficult suture and anastomosis techniques.

FB



HELLBERG-KUPKA

**BM320R**

mit Anreichsperre  
with locking ratchet  
210 mm, 8 1/4"



REIN-KUPKA

**BM310R**

ohne Sperre  
without ratchet  
190 mm, 7 1/2"



REIN-KUPKA

**BM311R**

mit Sperre  
with ratchet  
190 mm, 7 1/2"

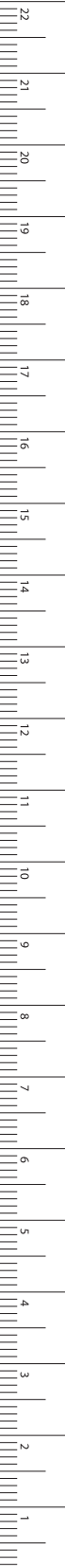

MILLIMETERS

# Herz- und Gefäß-Chirurgie – Cardiovascular Surgery

DUROGRIP® Nadelhalter

DUROGRIP® Needle Holders

»grazil«

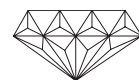

FB

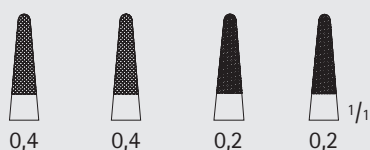

BM033R	BM034R	BM063R	BM064R
165 mm	210 mm	165 mm	210 mm
6 1/2"	8 1/4"	6 1/2"	8 1/4"

DE BAKLEY

**BM033R-BM064R**

sehr fein

very delicate

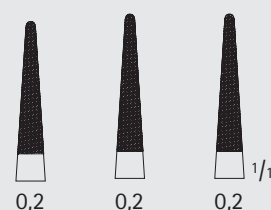

BM025R	BM026R	BM027R
180 mm	200 mm	230 mm
7"	8"	9"

**BM025R-BM027R**

sehr fein

very delicate

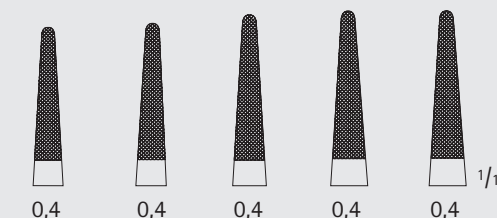

BM032R	BM035R	BM036R	BM037R	BM038R
150 mm	180 mm	230 mm	250 mm	305 mm
6"	7"	9"	10"	12"

DE BAKLEY

**BM032R-BM038R**

1/2

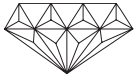

»grazil«

## Herz- und Gefäß-Chirurgie – Cardiovascular Surgery

DUROGRIP® Nadelhalter  
DUROGRIP® Needle Holders

FB

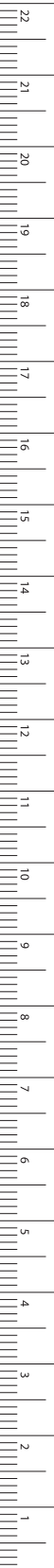

MILLIMETERS



DE BAKEY

**BM040R**

schlankes Modell  
slender pattern  
305 mm, 12"

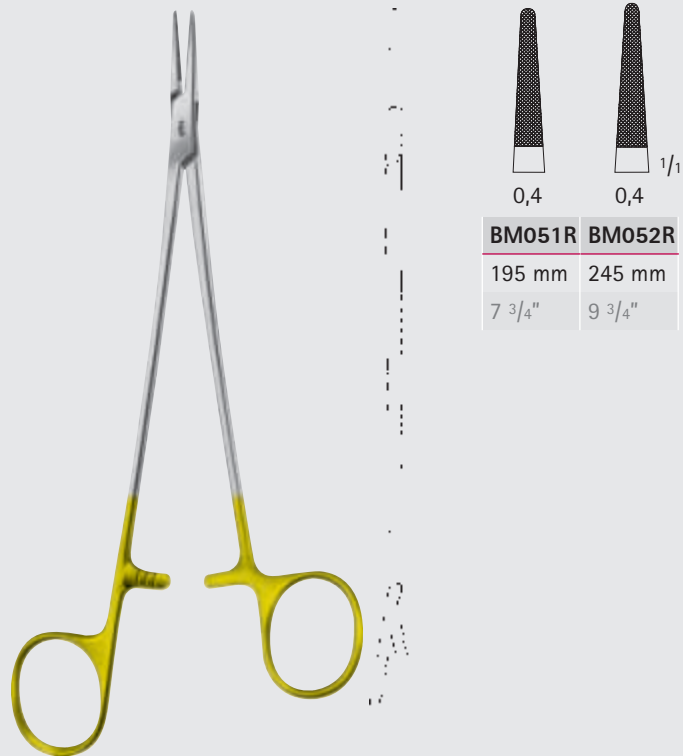

DE BAKEY

**BM051R-BM052R**

Ringe griffgünstig abgesetzt  
und gebogen  
one extended handle and curved  
rings ensure optimum grip

BM051R	BM052R
195 mm	245 mm
7 3/4"	9 3/4"

## Herz- und Gefäß-Chirurgie – Cardiovascular Surgery

DUROGRIP® Nadelhalter

DUROGRIP® Needle Holders

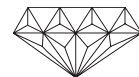

Diese Spezialmodelle mit extra schmalen Mäulern eignen sich für atraumatische Nadeln und für feine Gefäßnadeln.

These special patterns with extremely fine jaws are suitable for holding non-traumatic needles and fine vein needles.

FB



BM074R	BM075R	BM076R
150 mm	180 mm	230 mm
6"	7"	9"

RYDER

**BM074R-BM076R**

mit glattem Maul  
with smooth jaws



1/2

**BM184R**

200 mm, 8"

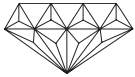

## Herz- und Gefäß-Chirurgie – Cardiovascular Surgery

DUROGRIP® Nadelhalter  
DUROGRIP® Needle Holders

Diese Spezialmodelle mit extra schmalen Mäulern eignen sich für atraumatische Nadeln und für feine Gefäßnadeln.

These special patterns with extremely fine jaws are suitable for holding non-traumatic needles and fine vein needles.

FB

»grazil«



BM054R	BM055R	BM056R	BM057R	BM058R
135 mm	155 mm	175 mm	210 mm	230 mm
5 1/4"	6"	7"	8 1/4"	9"

RYDER

**BM054R-BM058R**

sehr fein  
very delicate

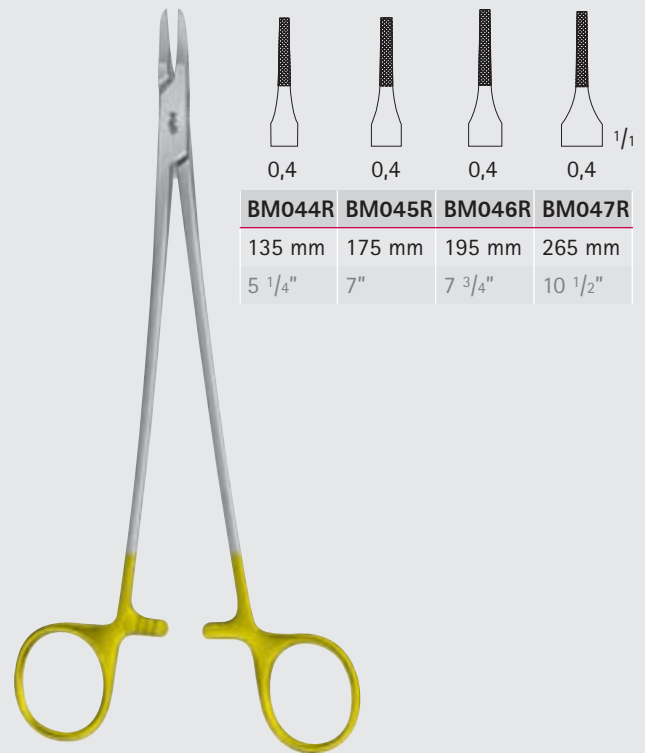

BM044R	BM045R	BM046R	BM047R
135 mm	175 mm	195 mm	265 mm
5 1/4"	7"	7 3/4"	10 1/2"

RYDER

**BM044R-BM047R**



MILLIMETERS



**DE BAKY**

1 : 2 Zahnreihen

1 : 2 rows of teeth



**DE BAKY**

2 : 3 Zahnreihen

2 : 3 rows of teeth

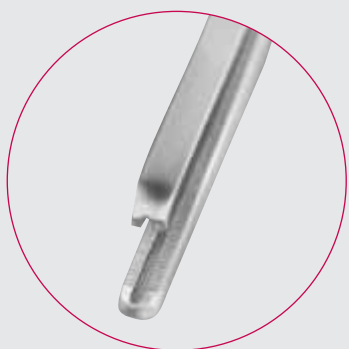

**COOLEY**

2 : 2 Zahnreihen

2 : 2 rows of teeth







DE BAKEY Zahnung

# Herz- und Gefäß-Chirurgie – Cardiovascular Surgery

Ultra-Light-Pinzetten

Ultra-Light-Forceps

Toothing DE BAKEY

**AIRAUMATA®**

**FB**



Model	Tip Width	Length (mm)	Length (inches)
FC411R	1,2 mm	150 mm	6"
FC412R	1,5 mm	200 mm	8"
FC413R	1,5 mm	240 mm	9 1/2"
FC418R	1,5 mm	300 mm	12"

DE BAKEY  
**FC411R-FC418R**



MILLIMETERS

# Herz- und Gefäß-Chirurgie – Cardiovascular Surgery

Pinzetten  
Forceps

DE BAKEY Zahnung

**ARAUMATA®** Toothing DE BAKEY

FB



FB394R	FB395R	FB396R
150 mm	195 mm	240 mm
6"	7 3/4"	9 1/2"

DE BAKEY  
**FB394R-FB396R**

FB411R	FB412R	FB418R	FB419R
150 mm	200 mm	240 mm	300 mm
6"	8"	9 1/2"	12"

DE BAKEY  
**FB411R-FB419R**

FB400R	FB402R	FB404R	FB405R
150 mm	200 mm	240 mm	300 mm
6"	8"	9 1/2"	12"

DE BAKEY  
**FB400R-FB405R**

FB414R	FB415R	FB416R	FB417R
150 mm	200 mm	240 mm	300 mm
6"	8"	9 1/2"	12"

DE BAKEY  
**FB414R-FB417R**



DE BAKEY Zahnung

# Herz- und Gefäß-Chirurgie – Cardiovascular Surgery

Pinzetten  
Forceps

Toothing DE BAKEY



FB406R	FB407R	FB408R	FB409R
200 mm	240 mm	300 mm	350 mm
8"	9 1/2"	12"	14"

DE BAKEY  
**FB406R-FB409R**

COOLEY Zahnung

Toothing COOLEY

FB784R	FB785R	FB786R
150 mm	195 mm	240 mm
6"	7 3/4"	9 1/2"

COOLEY  
**FB784R-FB786R**

DE BAKEY  
**FB401R**  
150 mm, 6"

DE BAKEY  
**FB403R**  
200 mm, 8"

COOLEY  
**BD250R**  
200 mm, 8"

FB

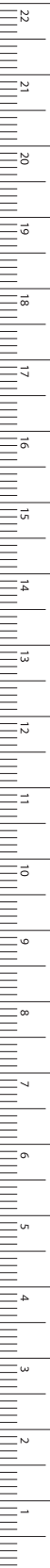

MILLIMETERS

### Gefäßclips nach MÜLLER

#### Merkmale:

- Atraumatisches Maulprofil
- Beidseitig angebrachte Griffplateaus zum sicheren Anlegen und Abnehmen des Clips.
- Exakt definierter Schließdruck für arterielle und venöse Gefäße.
- Gefäßclips eindeutig mit Schließdruck gekennzeichnet.
- Geschlossener Maulkasten zur sicheren Maulführung.  
Kein ungewolltes Verfangen des Fadens möglich.

### MÜLLER Vascular Clips

#### Features:

- Atraumatic mouth profile
- Handle plateau mounted on both sides for secure application and removal of the clip.
- Exactly defined closing pressure for arterial and venous vessels.
- Vascular clips are clearly marked with closing pressure.
- Closed mouth box guarantees precise guidance of the working tips.  
No risk of threads getting tangled up in clip.

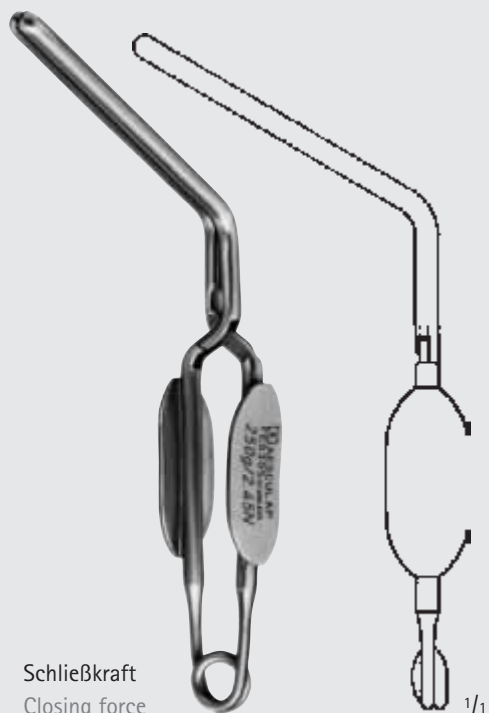

Schließkraft  
Closing force

MÜLLER

250 g **FE030S**

350 g **FE040S**

gerade  
straight

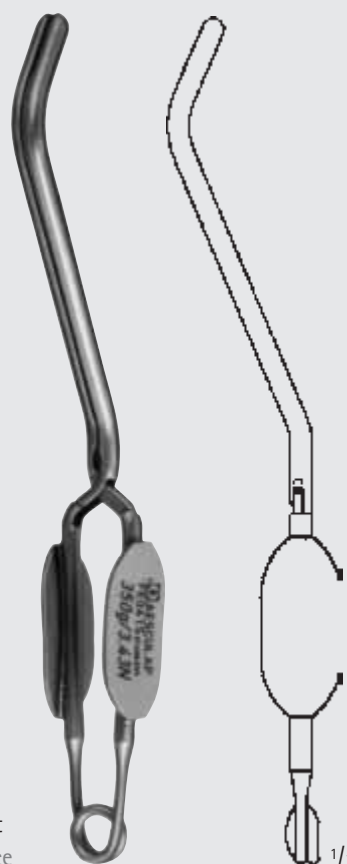

Schließkraft  
Closing force

MÜLLER

250 g **FE031S**

350 g **FE041S**

gebogen  
curved



DE BAKEY Zahnung

Toothing DE BAKEY

# Herz- und Gefäß-Chirurgie – Cardiovascular Surgery

Gefäßclips

Vascular Clips

FB

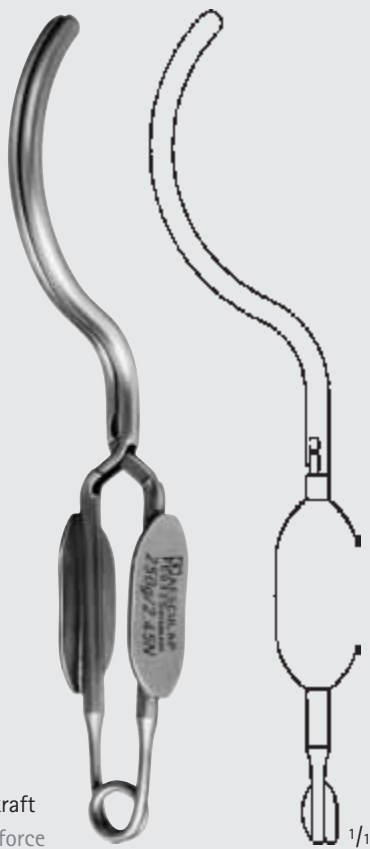

Schließkraft  
Closing force

MÜLLER

250 g **FE032S**

350 g **FE042S**

Spitze gebogen  
curved tips

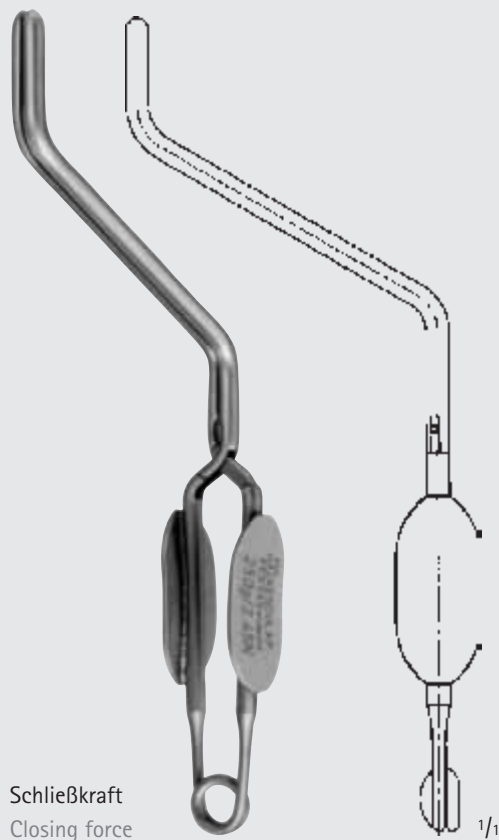

Schließkraft  
Closing force

MÜLLER

250 g **FE034S**

350 g **FE044S**

kniegebogen  
knee-bent

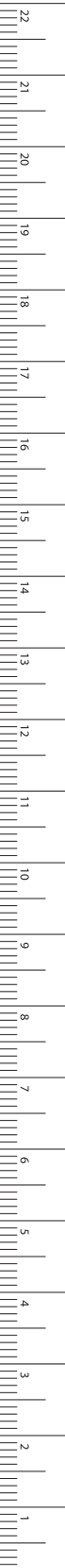

MILLIMETERS

# Herz- und Gefäß-Chirurgie – Cardiovascular Surgery

## Bulldogklemmen

## Bulldog Clamps

FB



### JOHNS-HOPKINS

**BH018R**

Zange zum Anlegen und Abnehmen der Bulldogklemmen BH011R - BH031R und FB420R - FB427R

Forceps for applying and removing bulldog clamps BH011R - BH031R and FB420R - FB427R

240 mm, 9 3/4"

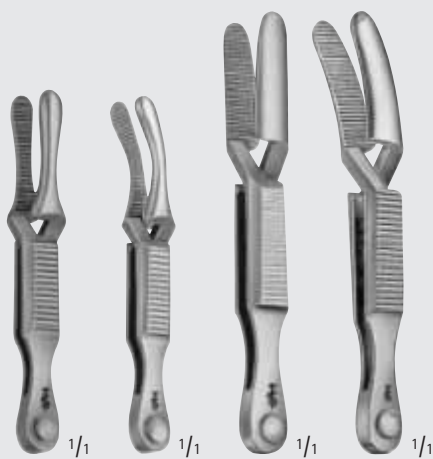

**BH020R** **BH021R** **BH026R** **BH027R**  
**BH022R** **BH023R**

### DIEFFENBACH

Gesamtlänge: Maullänge:  
 Total length: Jaw length:

<b>BH020R</b>	38 mm, 1 1/2"	12 mm, 1/2"
<b>BH022R</b>	48 mm, 2"	16 mm, 5/8"
<b>BH021R</b>	38 mm, 1 1/2"	12 mm, 1/2"
<b>BH023R</b>	48 mm, 2"	16 mm, 5/8"
<b>BH026R</b>	58 mm, 2 1/8"	16 mm, 5/8"
<b>BH027R</b>	58 mm, 2 1/8"	16 mm, 5/8"



**BH011R-BH017R**

### JOHNS-HOPKINS

Gesamtlänge: Maullänge:  
 Total length: Jaw length:

<b>BH011R</b>	38 mm, 1 1/2"	12 mm, 1/2"
<b>BH012R</b>	48 mm, 2"	17 mm, 5/8"
<b>BH013R</b>	56 mm, 2 1/8"	25 mm, 1"
<b>BH014R</b>	63 mm, 2 1/2"	30 mm, 1 3/16"
<b>BH015R</b>	70 mm, 2 3/4"	33 mm, 1 1/4"
<b>BH016R</b>	80 mm, 3 1/8"	42 mm, 1 3/4"
<b>BH017R</b>	91 mm, 3 1/2"	52 mm, 2"



# Herz- und Gefäß-Chirurgie – Cardiovascular Surgery

## Bulldogklemmen

## Bulldog Clamps

FB



1/1

DE BAKEY-HESS

**BH030R**

Gesamtlänge: 34 mm  
 Total length: 1 3/8"  
 Maullänge: 20 mm  
 Jaw length: 3/4"



**FB328R**

Gesamtlänge: 35 mm  
 Total length: 1 3/8"  
 Maullänge: 14 mm  
 Jaw length: 1/2"



**FB329R**

Gesamtlänge: 35 mm  
 Total length: 1 3/8"  
 Maullänge: 14 mm  
 Jaw length: 1/2"



**FB330R**

Gesamtlänge: 45 mm  
 Total length: 1 3/4"  
 Maullänge: 19 mm  
 Jaw length: 3/4"



1/1

**FB331R**

Gesamtlänge: 45 mm  
 Total length: 1 3/4"  
 Maullänge: 19 mm  
 Jaw length: 3/4"



1/1

DE BAKEY-HESS

**BH031R**

Gesamtlänge: 43 mm  
 Total length: 1 7/10"  
 Maullänge: 30 mm  
 Jaw length: 1 3/16"



DIETHRICH

**MB285R**

Gesamtlänge: 55 mm  
 Total length: 2 1/8"  
 Maullänge: 13 mm  
 Jaw length: 1/2"



DIETHRICH

**BH032R**

Gesamtlänge: 48 mm  
 Total length: 1 7/8"  
 Maullänge: 10 mm  
 Jaw length: 3/8"



1/1

DIETHRICH

**BH034R**

Gesamtlänge: 48 mm  
 Total length: 1 7/8"  
 Maullänge: 13 mm  
 Jaw length: 1/2"

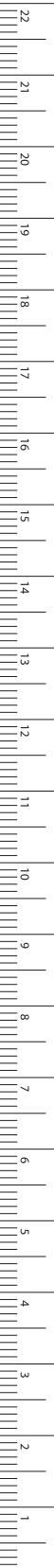

MILLIMETERS

# Herz- und Gefäß-Chirurgie – Cardiovascular Surgery

## Bulldogklemmen

### Bulldog Clamps

DE BAKEY Zahnung

ARAUMATA®

Toothing DE BAKEY

#### Mini-Bulldogklemmen

Schließdruck 180 g

Mini-bulldog clamps

Closing force 180 g

gerade  
straight



gewinkelt, 55°  
angled, 55°



curved  
gebogen

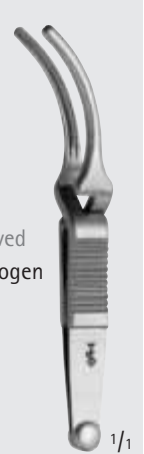

	<b>FB362R</b>	<b>FB364R</b>	<b>FB366R</b>	<b>FB363R</b>	<b>FB365R</b>	<b>FB367R</b>	<b>FB369R</b>
Gesamtlänge:	50 mm	55 mm	60 mm	50 mm	50 mm	55 mm	55 mm
Total length:	2"	2 1/8"	2 3/8"	2"	2"	2 1/8"	2 1/8"
Maullänge:	10 mm	14 mm	20 mm	10 mm	14 mm	20 mm	20 mm
Jaw length:	3/8"	1/2"	3/4"	3/8"	1/2"	3/4"	3/4"



DE BAKEY  
**FB352R**



DE BAKEY  
**FB353R**



GLOVER  
**FB431R**



DE BAKEY  
**FB357R**



DE BAKEY  
**FB358R**



DE BAKEY  
**FB359R**

Gesamtlänge:	50 mm	48 mm	52 mm	73 mm	99 mm	95 mm
Total length:	2"	2"	2"	2 3/4"	4"	3 1/2"
Maullänge:	27 mm	27 mm	35 mm	38 mm	63 mm	54 mm
Jaw length:	1 1/8"	1 1/8"	1 1/3"	1 1/2"	2 1/2"	2 1/8"





DE BAKEY Zahnung

# Herz- und Gefäß-Chirurgie – Cardiovascular Surgery

Bulldogklemmen  
Bulldog Clamps

Toothing DE BAKEY **AIRAUMATA®**

FB



DE BAKEY  
**FB420R**

Gesamtlänge: 80 mm  
Total length: 3 1/8"  
Maullänge: 25 mm  
Length of jaw: 1"

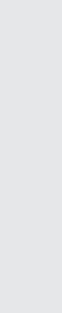

DE BAKEY  
**FB422R**

90 mm  
3 1/2"  
35 mm  
1 3/8"

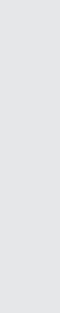

DE BAKEY  
**FB424R**

105 mm  
4 1/8"  
50 mm  
2"

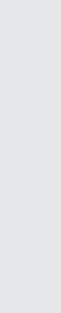

DE BAKEY  
**FB426R**

124 mm  
5"  
68 mm  
2 3/4"



DE BAKEY  
**FB421R**

78 mm  
3 1/8"  
23 mm  
1"

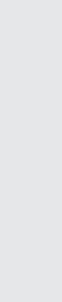

DE BAKEY  
**FB423R**

86 mm  
3 3/8"  
31 mm  
1 1/8"

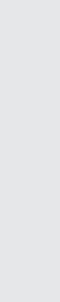

DE BAKEY  
**FB425R**

97 mm  
3 3/4"  
42 mm  
1 3/4"

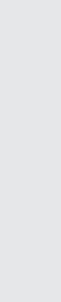

DE BAKEY  
**FB427R**

114 mm  
4 1/2"  
58 mm  
2 3/8"



GLOVER  
**FB432R**

Gesamtlänge: 68 mm  
Total length: 2 3/4"  
Maullänge: 33 mm  
Length of jaw: 1 3/8"

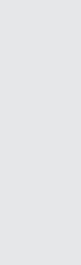

GLOVER  
**FB434R**

96 mm  
3 3/4"  
50 mm  
2"

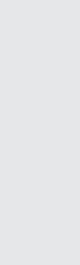

GLOVER  
**FB436R**

117 mm  
4 3/4"  
69 mm  
2 3/4"



GLOVER  
**FB433R**

65 mm  
2 1/2"  
33 mm  
1 3/8"

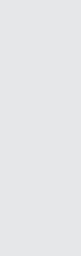

GLOVER  
**FB435R**

91 mm  
3 1/2"  
50 mm  
2"

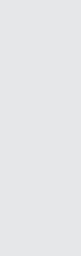

GLOVER  
**FB437R**

110 mm  
4 3/8"  
69 mm  
2 3/4"

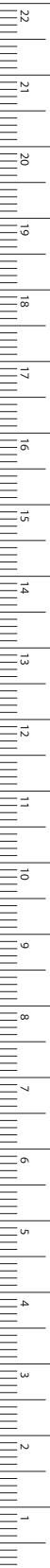

MILLIMETERS

# Herz- und Gefäß-Chirurgie – Cardiovascular Surgery

Bulldogklemmen mit Ringgriffen

Ring Handle Bulldog Clamps

DE BAKEY Zahnung

ARAUMATA®

Toothing DE BAKEY

FB



DE BAKEY

**FB540R**

gerade

straight

130 mm, 5 1/8"



DE BAKEY

**FB541R**

Maul gebogen

curved jaws

125 mm, 5"

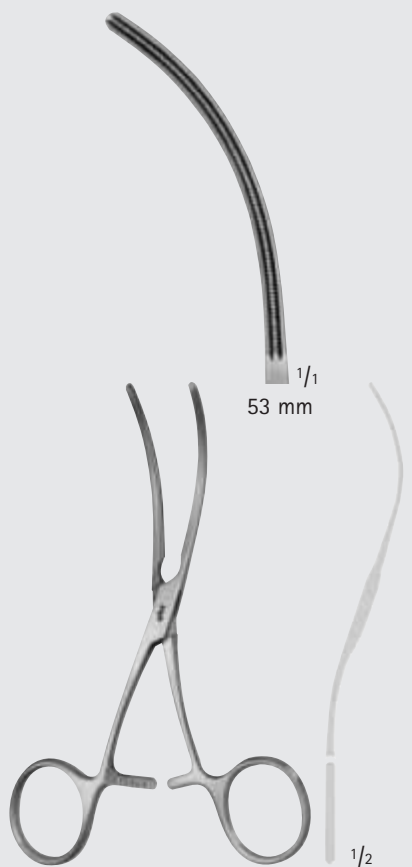

DE BAKEY

**FB542R**

S-förmig

S-shaped

125 mm, 5"

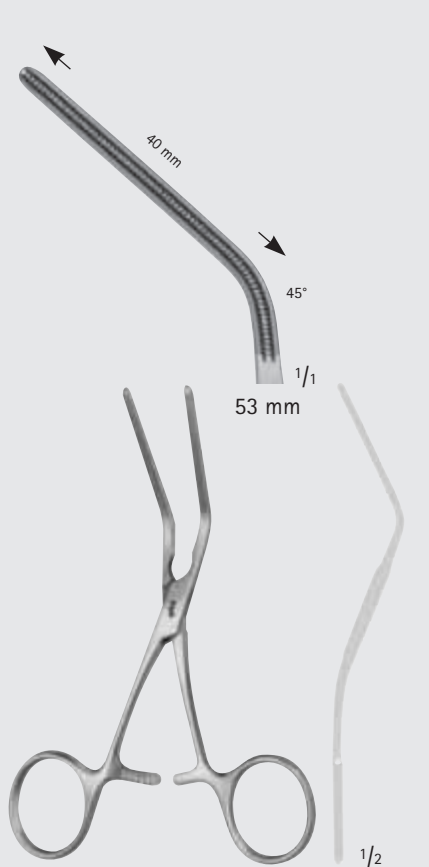

DE BAKEY

**FB543R**

45° winklig gebogen

angled 45°

125 mm, 5"

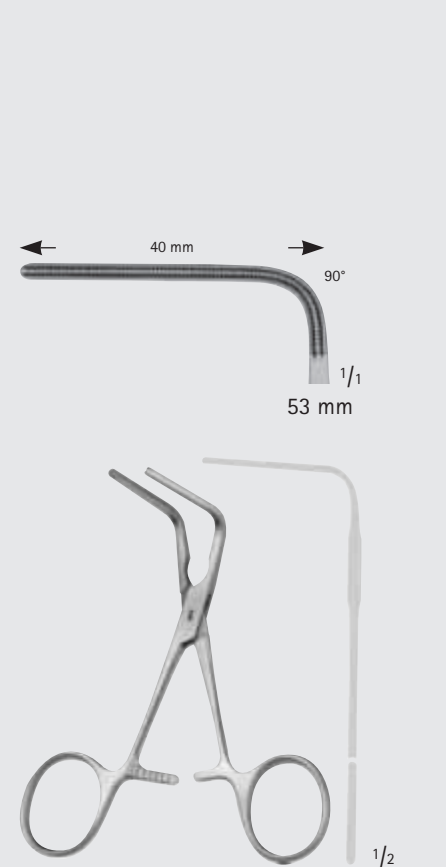

DE BAKEY

**FB544R**

90° winklig gebogen

angled 90°

105 mm, 4 1/8"



DE BAKEY Zahnung

## Herz- und Gefäß-Chirurgie – Cardiovascular Surgery

Anastomosen-, Mehrzweckklemmen für Neugeborene

Anastomosis-, Multi-Purpose-Clamps for Neonatales

Toothing DE BAKEY **AIRAUMATA®**

FB

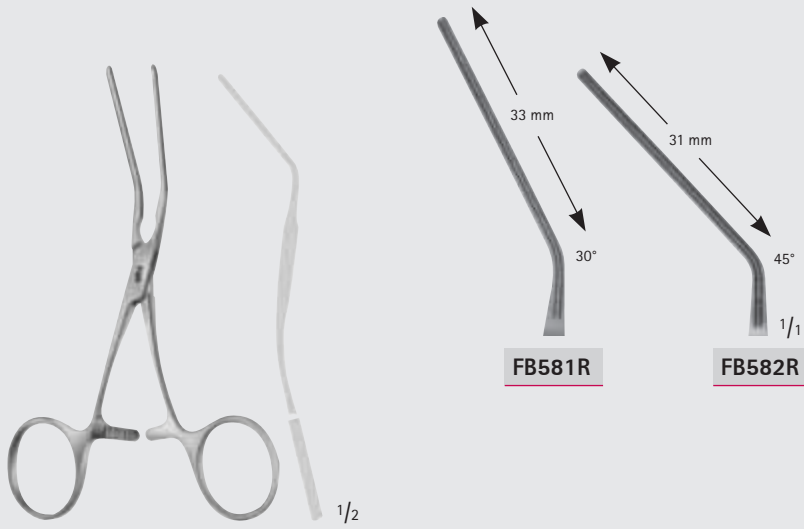

CASTANEDA

**FB581R-FB582R**

120 mm, 4 3/4"

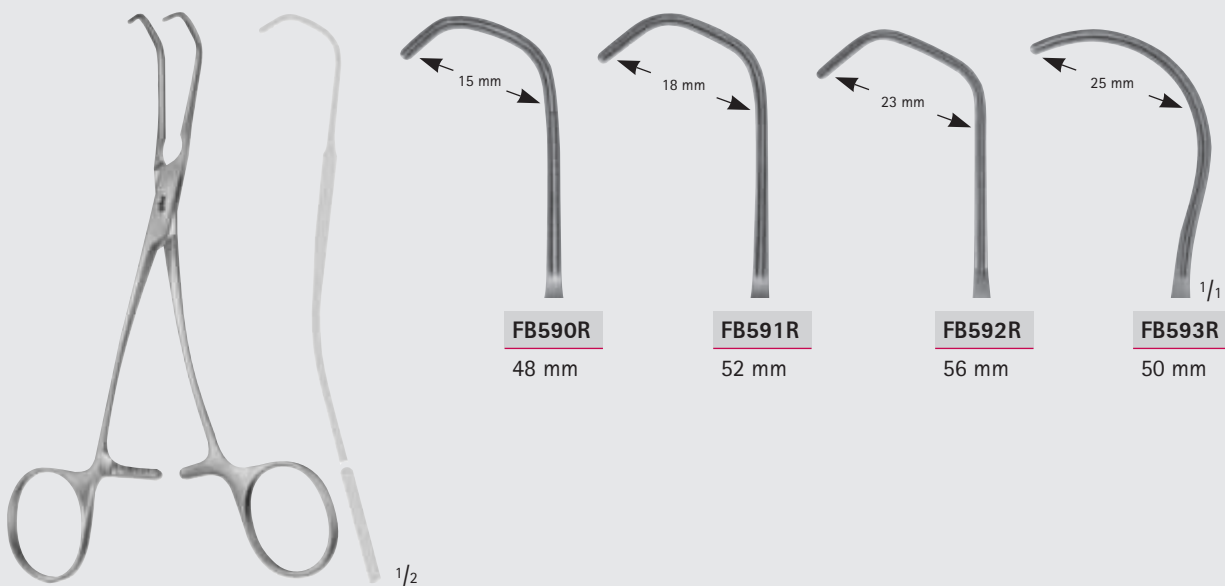

CASTANEDA

**FB590R-FB593R**

155 mm, 6"

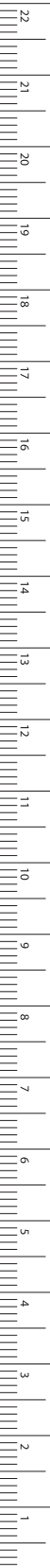

MILLIMETERS

# Herz- und Gefäß-Chirurgie – Cardiovascular Surgery

Anastomosen- und Mehrzweckklemmen - Kinder-Modelle

Anastomosis- and Multi-Purpose-Clamps - Pediatric Patterns

**AIRAUMATA**<sup>®</sup>

DE BAKEY Zahnung

Toothing DE BAKEY

**FB**



**FB557R**

160 mm

6 1/2"

**FB558R**

170 mm

6 3/4"

DE BAKEY

**FB557R-FB558R**

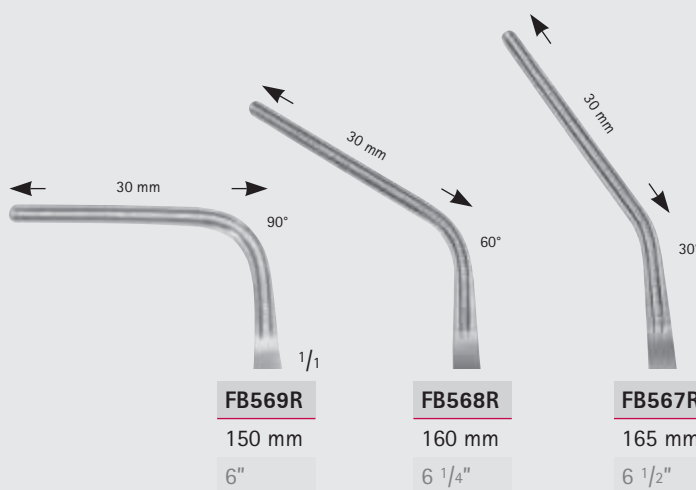

**FB569R**

150 mm

6"

**FB568R**

160 mm

6 1/4"

**FB567R**

165 mm

6 1/2"

COOLEY

**FB567R-FB569R**



DE BAKEY Zahnung

# Herz- und Gefäß-Chirurgie – Cardiovascular Surgery

Anastomosen-, Mehrzweckklemmen - Kinder-Modelle

Toothing DE BAKEY

**AIRAUMATA®**

Anastomosis-, Multi-Purpose-Clamps - Pediatric Patterns

**FB**



**FB559R**

170 mm

6 3/4"



**FB560R**

170 mm

6 3/4"

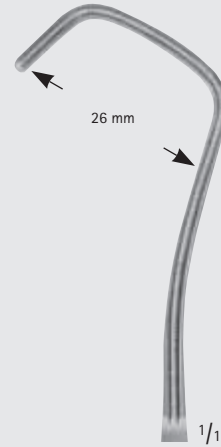

**FB561R**

175 mm

7"

DERRA

**FB559R-FB561R**

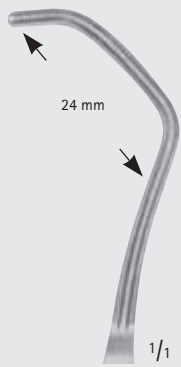

1/1

1/2

COOLEY

**FB563R**

160 mm, 6 1/4"

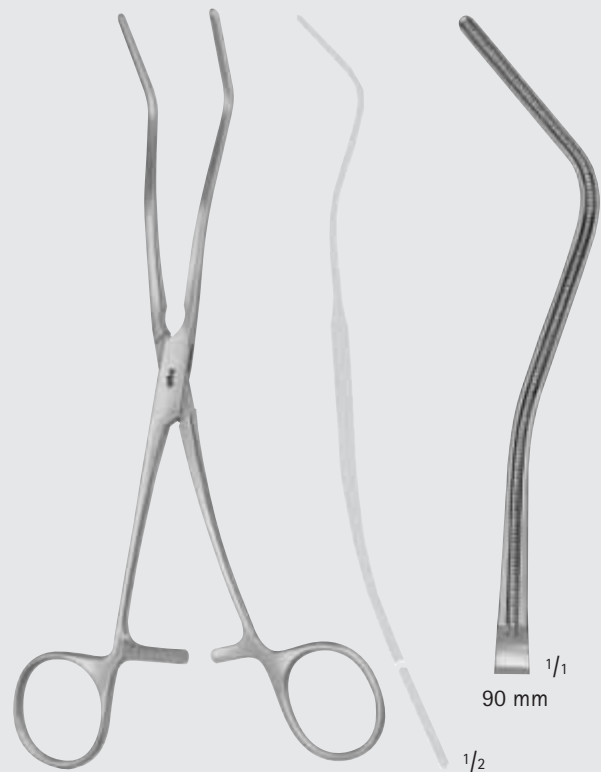

1/1  
90 mm

1/2

COOLEY

**FB570R**

200 mm, 8"

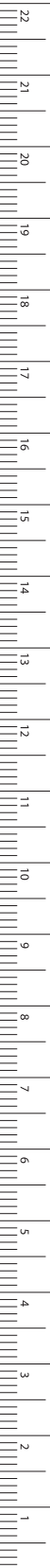

MILLIMETERS

# Herz- und Gefäß-Chirurgie – Cardiovascular Surgery

## Gefäßklemmen

### Hemostatic Forceps

DE BAKEY Zahnung

ARAUMATA®

Toothing DE BAKEY

FB

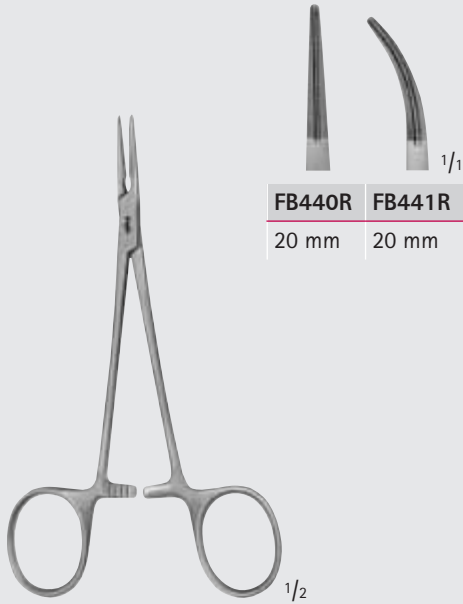
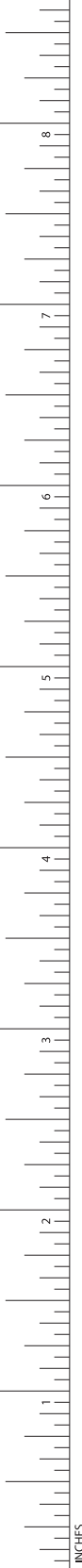

FB440R	FB441R
20 mm	20 mm

**FB440R-FB441R**

Mosquitoklemmen  
Mosquito Forceps  
125 mm, 5"



FB442R	FB443R
27 mm	27 mm

**FB442R-FB443R**

Mosquitoklemmen  
Mosquito forceps  
165 mm, 6 1/2"



FB446R	FB447R
40 mm	40 mm

DE BAKEY-BAINBRIDGE

**FB446R-FB447R**

155 mm, 6"



FB448R	FB449R
65 mm	65 mm

DE BAKEY-BAINBRIDGE

**FB448R-FB449R**

180 mm, 7"



DE BAKEY Zahnung

# Herz- und Gefäß-Chirurgie – Cardiovascular Surgery

Gefäßklemmen

Toothing DE BAKEY

**AIRAUMATA®**

Hemostatic Forceps

**FB**

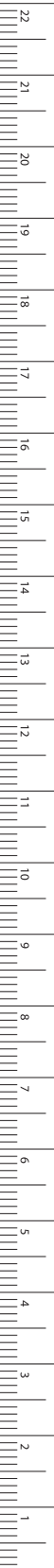

MILLIMETERS



1/2



1/1

<b>FB444R</b>	<b>FB445R</b>
50 mm	50 mm

PEAN

<b>FB444R-FB445R</b>
155 mm, 6"



DE BAKEY-PEAN

**FB526R-FB535R**

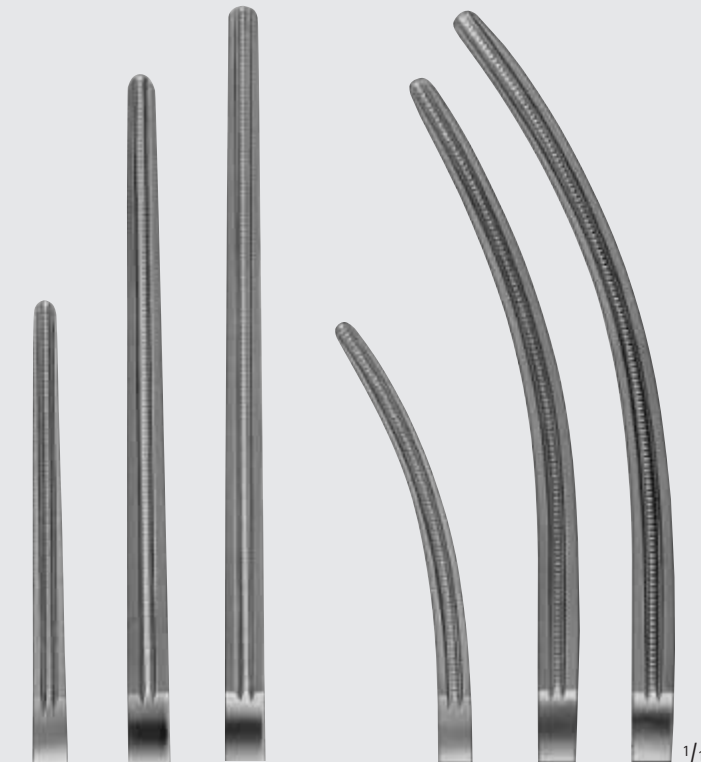

1/1

<b>FB526R</b>	<b>FB532R</b>	<b>FB534R</b>
60 mm	89 mm	99 mm
200 mm	265 mm	280 mm
8"	10 1/2"	11"

<b>FB527R</b>	<b>FB533R</b>	<b>FB535R</b>
60 mm	89 mm	99 mm
200 mm	260 mm	275 mm
8"	10 1/4"	10 3/4"

# Herz- und Gefäß-Chirurgie – Cardiovascular Surgery

Klemmen für Nieren- und Pankreaseingriffe

Kidney and Pankreas Clamps

DE BAKEY Zahnung

ARAUMATA®

Toothing DE BAKEY

FB

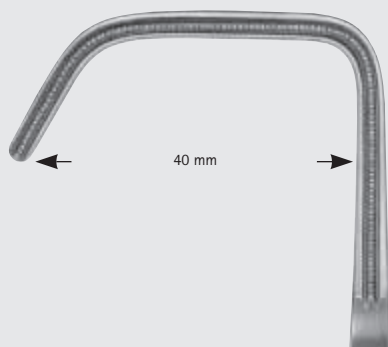

40 mm

FB528R

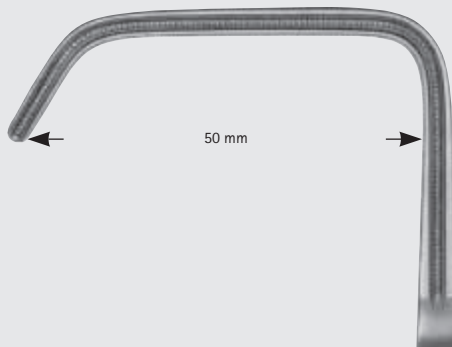

50 mm

FB529R



HOPT



65 mm

FB530R

1/1

FB528R	230 mm	9"
FB529R	235 mm	9 1/4"
FB530R	245 mm	9 3/4"





DE BAKEY Zahnung

# Herz- und Gefäß-Chirurgie – Cardiovascular Surgery

Präparier- und Ligaturklemmen

Dissecting- and Ligature Forceps

Toothing DE BAKEY

**AIRAUMATA®**

**FB**

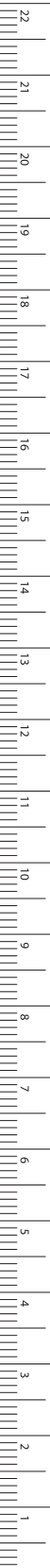

MILLIMETERS



**FB486R**  
81 mm

**FB487R**  
81 mm

1/1

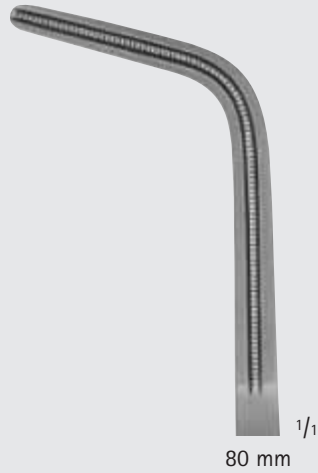

80 mm

1/1

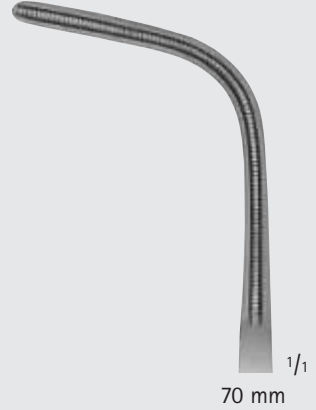

70 mm

1/1



DE BAKEY-RUMEL

<b>FB486R</b>	250 mm	10"
<b>FB487R</b>	245 mm	9 3/4"



DE BAKEY-MIXTER

**FB497R**

285 mm, 11 1/4"

1/2



DE BAKEY-MC QUIGG-MIXTER

**FB496R**

210 mm, 8 1/4"

1/2

# Herz- und Gefäß-Chirurgie – Cardiovascular Surgery

Präparier- und Ligaturklemmen, Profunda Klemmen

Dissecting- and Ligature Forceps, Profunda Clamps

DE BAKEY Zahnung

**AIRAUMATA**<sup>®</sup>

Toothing DE BAKEY

**FB**

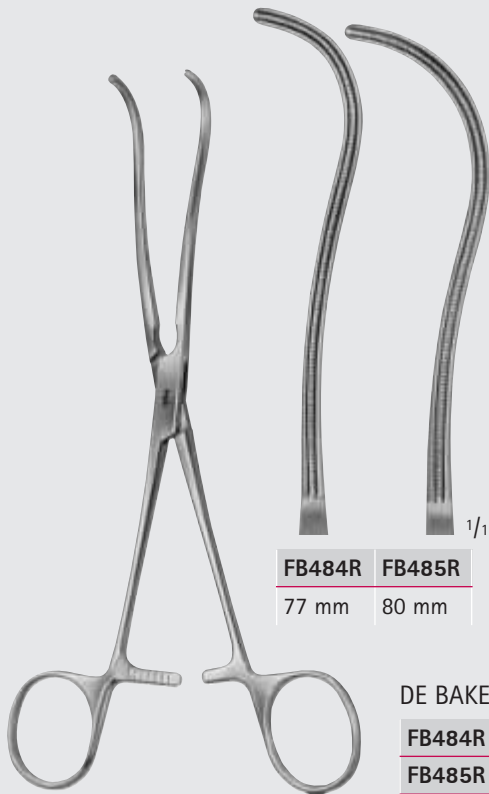

<b>FB484R</b>	<b>FB485R</b>
77 mm	80 mm

DE BAKEY

<b>FB484R</b>	190 mm	7 1/2"
<b>FB485R</b>	230 mm	9"



GREGORY

**MB750R** 57 mm

**MB751R** 62 mm

Profunda Klemmen

Profunda clamps

200 mm, 8"



94 mm

DE BAKEY

<b>FB483R</b>	240 mm, 9 1/2"
---------------	----------------



<b>FB498R</b>	<b>FB499R</b>
51 mm	75 mm

DE BAKEY

<b>FB498R</b>	210 mm	8 1/4"
<b>FB499R</b>	230 mm	9"



DE BAKEY Zahnung

# Herz- und Gefäß-Chirurgie – Cardiovascular Surgery

Anastomosenklemmen

Anastomosis Clamps

Toothing DE BAKEY AIRAUMATA®

FB

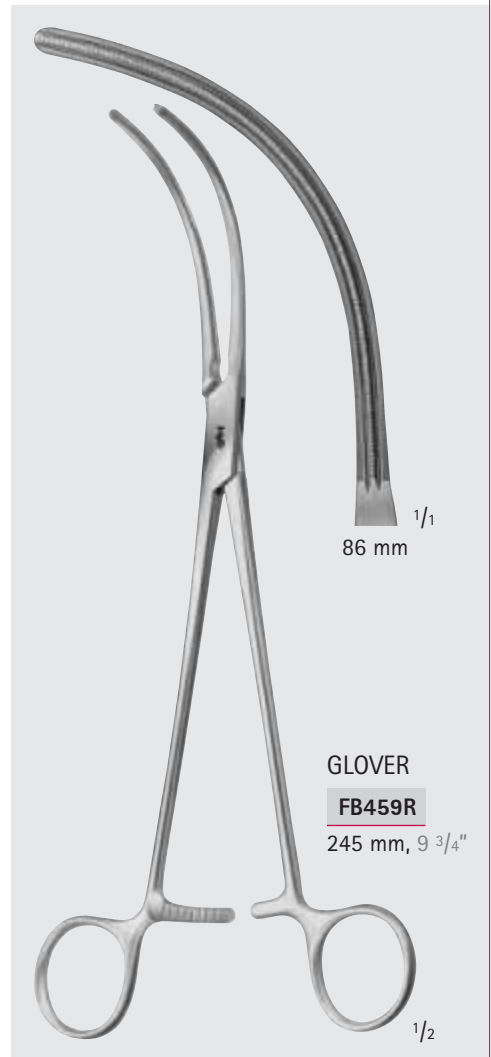
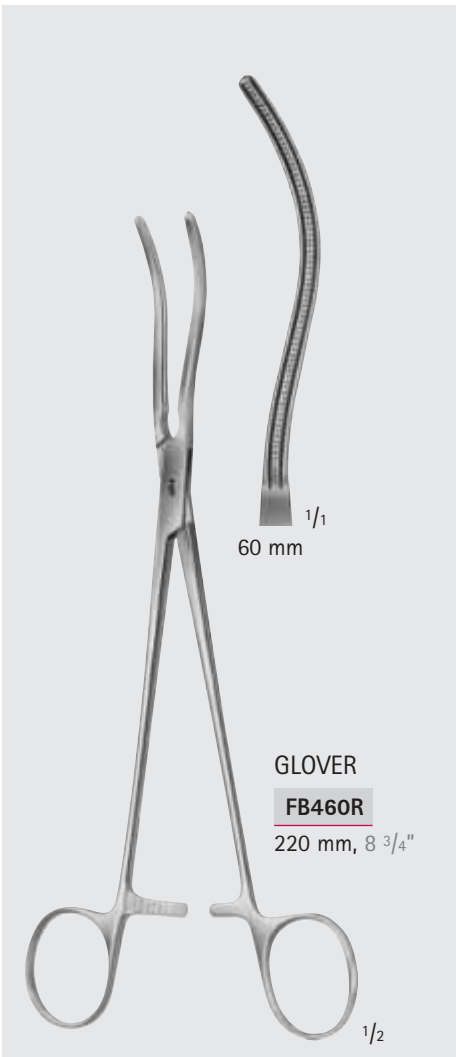
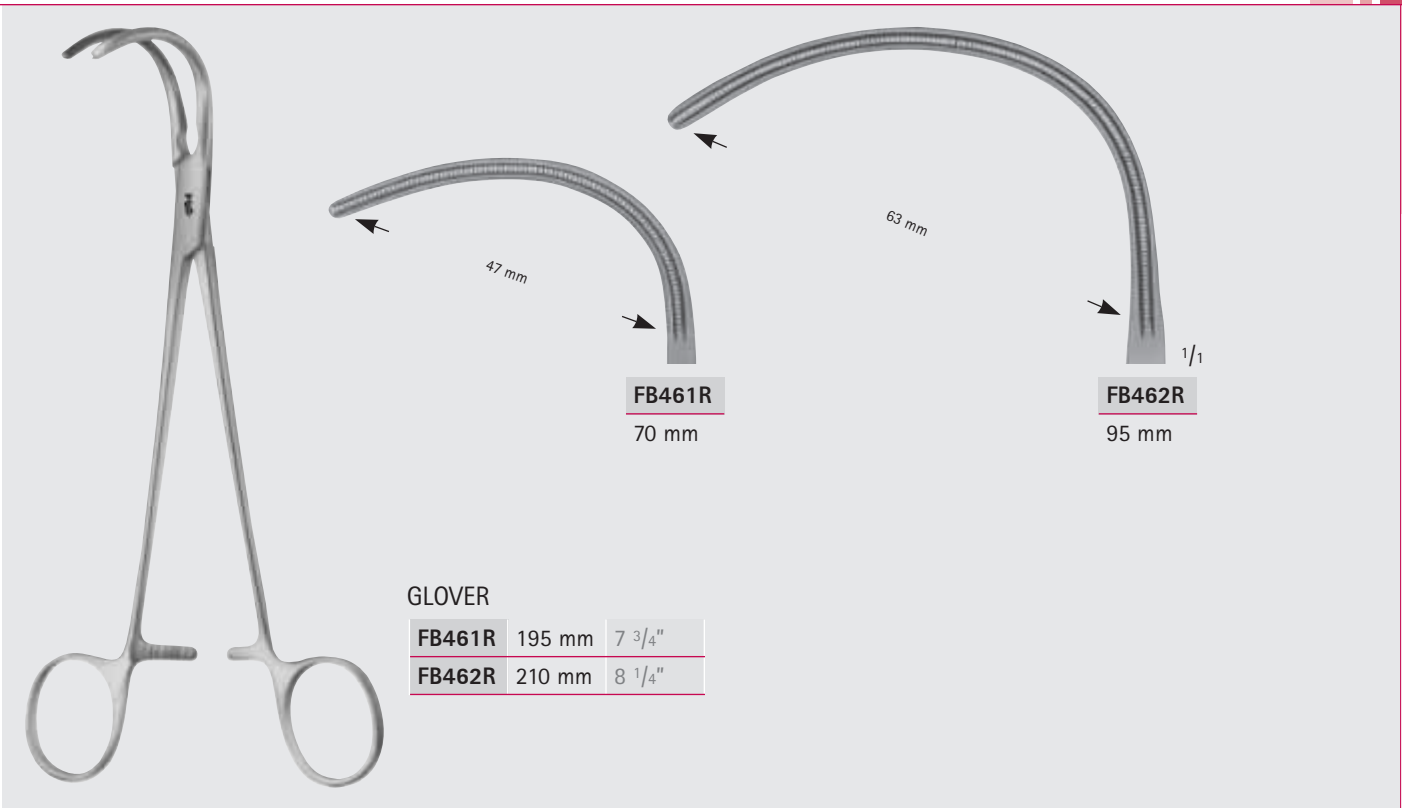

# Herz- und Gefäß-Chirurgie – Cardiovascular Surgery

Vena-Cava-Klemmen

Vena Cava Clamps

DE BAKEY Zahnung

ARAUMATA®

Toothing DE BAKEY

FB

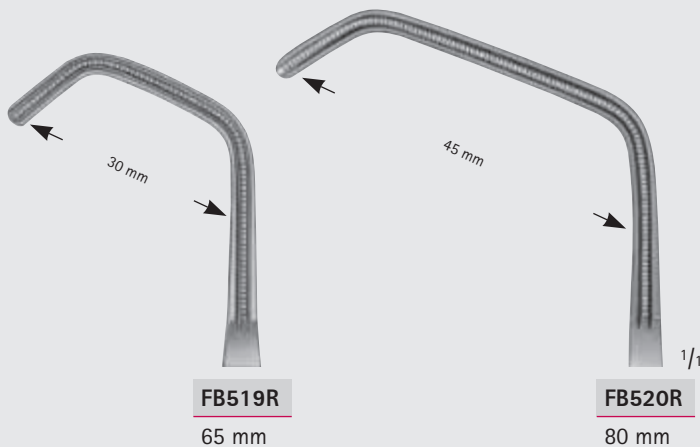

### DE BAKEY-BECK

<b>FB519R</b>	205 mm	8"
<b>FB520R</b>	210 mm	8 1/4"

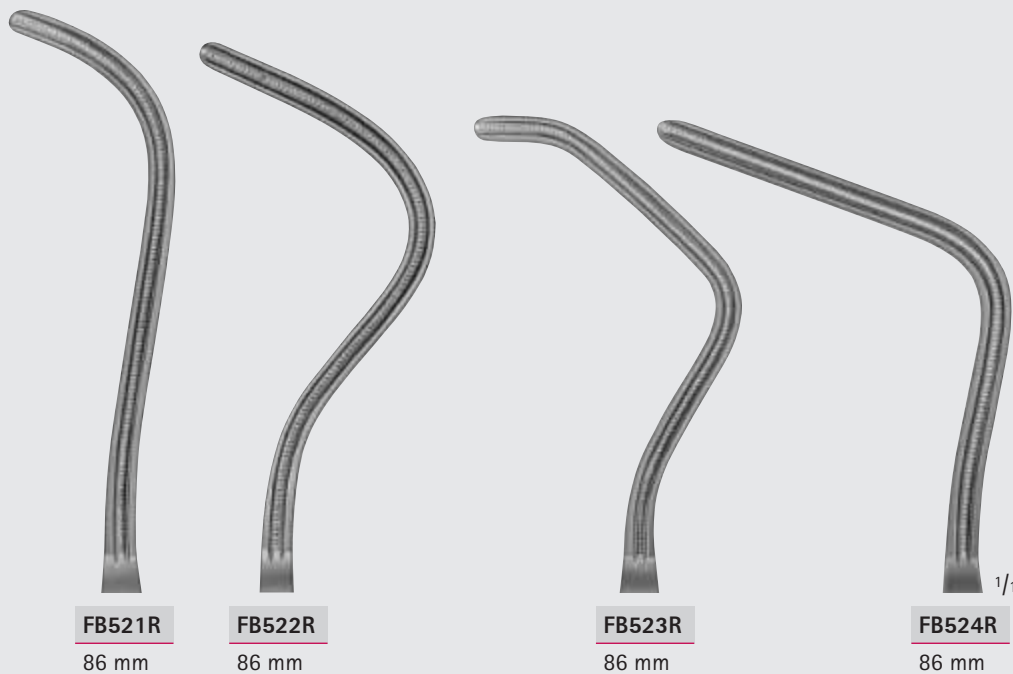

### DE BAKEY-HARKEN

<b>FB521R</b>	255 mm	10"
<b>FB522R</b>	245 mm	9 3/4"
<b>FB523R</b>	245 mm	9 3/4"
<b>FB524R</b>	245 mm	9 3/4"



DE BAKEY Zahnung

## Herz- und Gefäß-Chirurgie – Cardiovascular Surgery

Gefäßklemmen für Tangential-Verschluss

Tangential Occlusion Clamps

Toothing DE BAKEY

**AIRAUMATA®**

**FB**



DE BAKEY

Gesamtlänge:

Total Length:

Maullänge:

Jaw length:

	FB500R	FB501R	FB502R	FB503R	FB504R
Gesamtlänge:	220 mm	265 mm	270 mm	270 mm	280 mm
Total Length:	7 3/4"	10 1/4"	10 3/4"	10 3/4"	11"
Maullänge:	85 mm	95 mm	99 mm	103 mm	119 mm
Jaw length:	3 3/8"	3 3/4"	4"	4 1/8"	4 3/4"

MILLIMETERS

**FB**

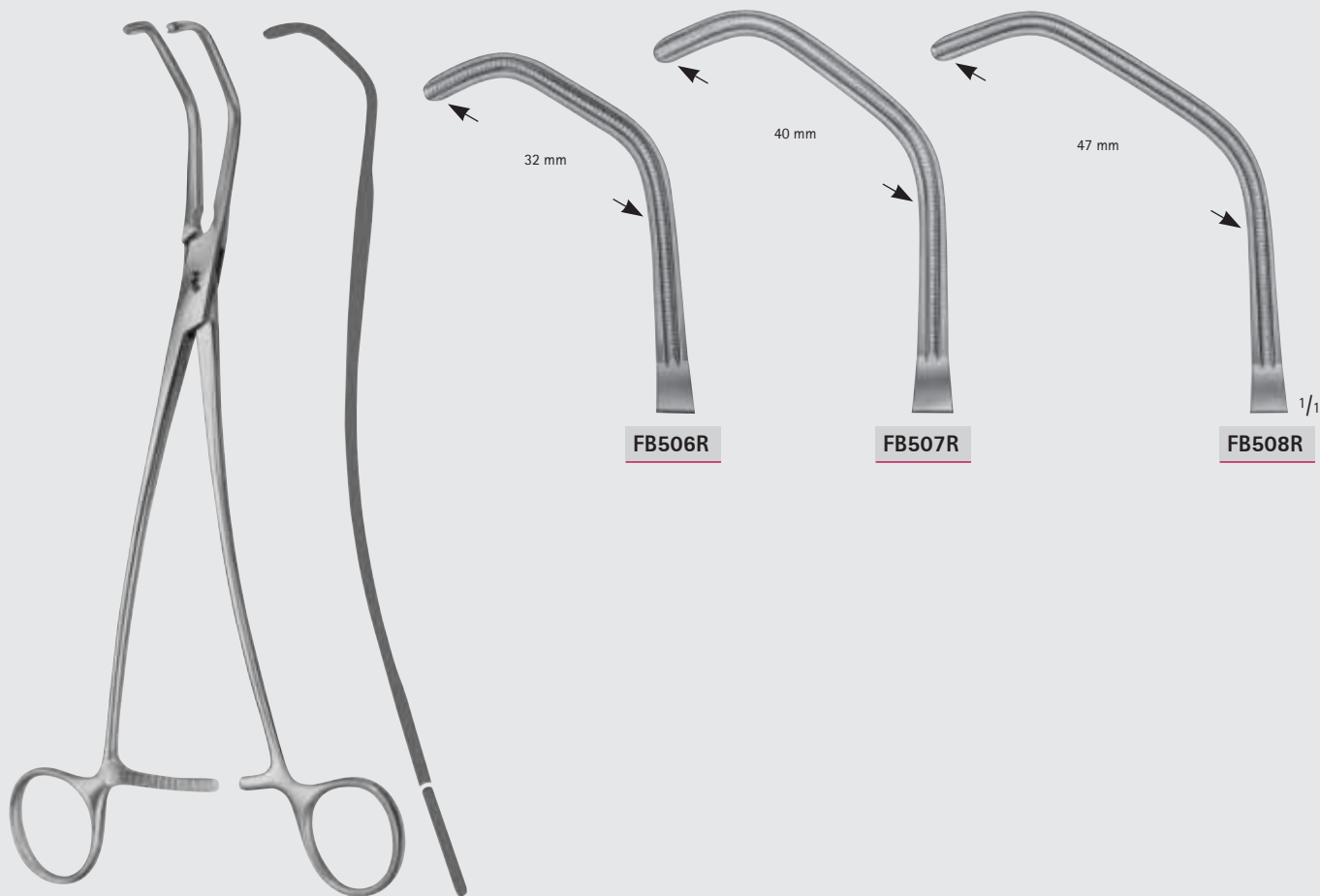

**DE BAKEY-SATINSKY**

	<b>FB506R</b>	<b>FB507R</b>	<b>FB508R</b>
Gesamtlänge:	235 mm	240 mm	245 mm
Total Length:	9 1/4"	9 1/2"	9 3/4"
Maullänge:	68 mm	76 mm	84 mm
Jaw length:	2 3/4"	3"	3 3/8"



DE BAKEY Zahnung

# Herz- und Gefäß-Chirurgie – Cardiovascular Surgery

Gefäßklemmen

Hemostatic Forceps

Toothing DE BAKEY AIRAUMATA®

FB

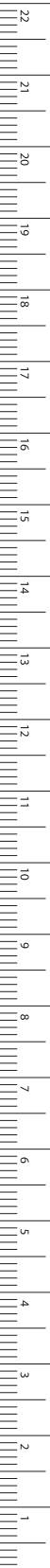
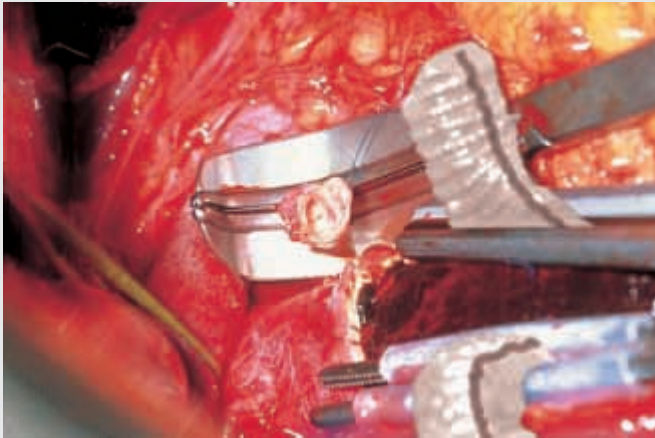

MILLIMETERS



**FB587R**  
235 mm  
9 1/4"



**FB588R**  
245 mm  
9 3/4"

ALLENBERG

**FB587R-FB588R**

mit Retraktionsblättern zum Weghalten von Weichteilen während der Anastomose  
with retraction blades for retraction of soft tissue during the anastomosis

# Herz- und Gefäß-Chirurgie – Cardiovascular Surgery

Coarctationsklemmen  
Coarctation Clamps

DE BAKEY Zahnung

AIRAUMATA®

Toothing DE BAKEY

FB

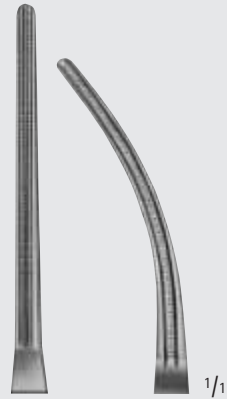

<b>FB552R</b>	<b>FB554R</b>
50 mm	50 mm

DE BAKEY

<b>FB552R</b>	170 mm	6 3/4"
<b>FB554R</b>	165 mm	6 1/2"

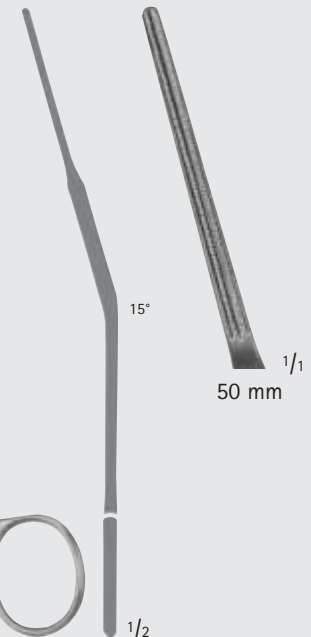

DE BAKEY

<b>FB553R</b>	165 mm, 6 1/2"
---------------	----------------

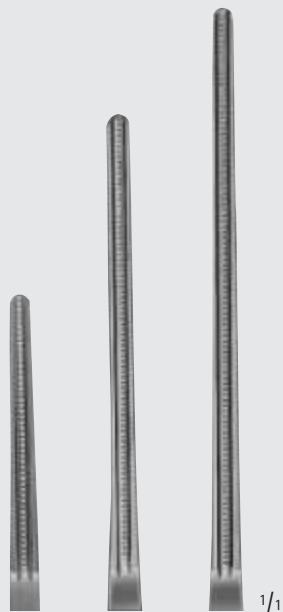

<b>FB452R</b>	<b>FB454R</b>	<b>FB456R</b>
41 mm	65 mm	80 mm

DE BAKEY

<b>FB452R</b>	205 mm	8"
<b>FB454R</b>	225 mm	9"
<b>FB456R</b>	240 mm	9 1/2"

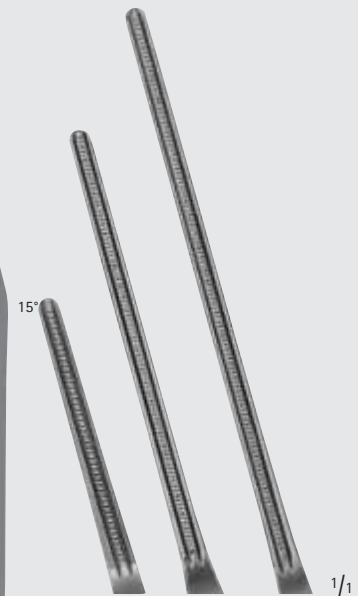

<b>FB453R</b>	<b>FB455R</b>	<b>FB457R</b>
41 mm	65 mm	80 mm

DE BAKEY

<b>FB453R</b>	200 mm	8"
<b>FB455R</b>	225 mm	9"
<b>FB457R</b>	240 mm	9 1/2"





DE BAKEY Zahnung

## Herz- und Gefäß-Chirurgie – Cardiovascular Surgery

Patent-Ductusklemmen, Peripheralklemmen

Toothing DE BAKEY

**AIRAUMATA®**

Patent-Ductus-Clamps, Peripheral-Vascular-Clamps

**FB**



DE BAKEY

**FB450R**

210 mm, 8 1/4"

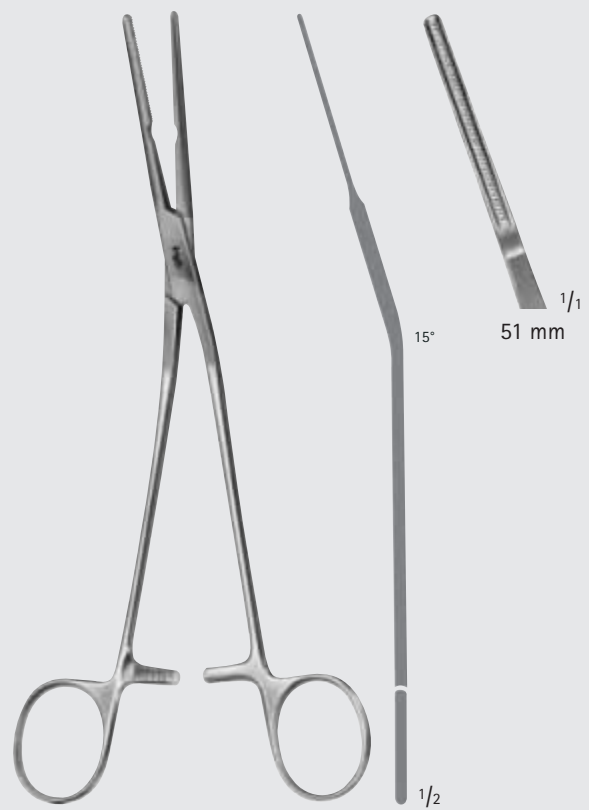

DE BAKEY

**FB451R**

210 mm, 8 1/4"

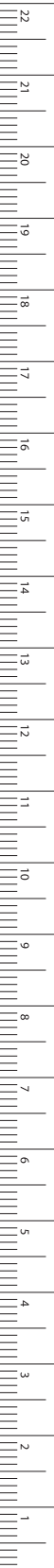

MILLIMETERS

# Herz- und Gefäß-Chirurgie – Cardiovascular Surgery

Patent-Ductusklemmen, Peripheralklemmen

Patent-Ductus-Clamps, Peripheral-Vascular-Clamps

DE BAKEY Zahnung

ARAUMATA®

Toothing DE BAKEY

FB

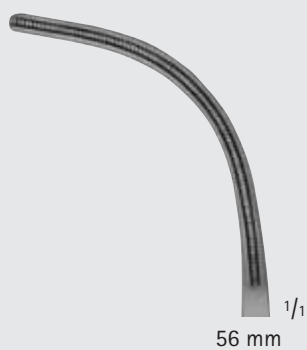

56 mm

1/1



90 mm

1/1



92,5 mm

1/1



1/2

DE BAKEY

**FB463R**

160 mm, 6 1/4"



1/2

DE BAKEY

**FB464R**

190 mm, 7 1/4"

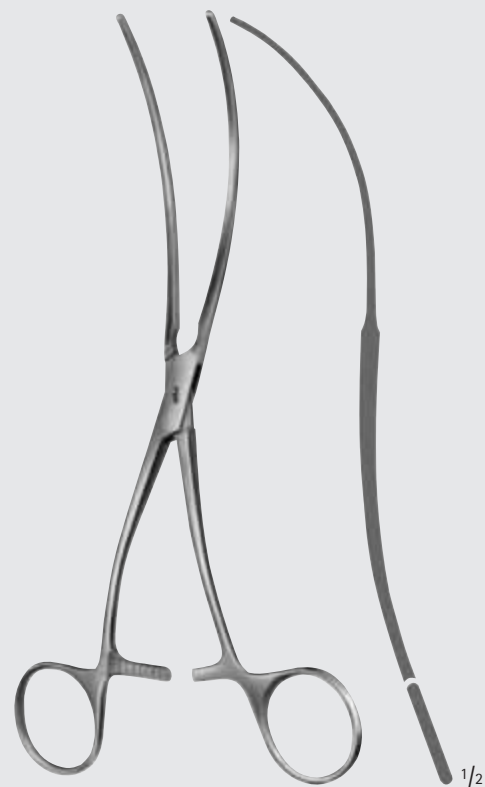

1/2

DE BAKEY

**FB465R**

200 mm, 8"



DE BAKEY Zahnung

# Herz- und Gefäß-Chirurgie – Cardiovascular Surgery

Toothing DE BAKEY **AIRAUMATA®**

Peripheralklemmen  
Peripheral-Vascular-Clamps

**FB**

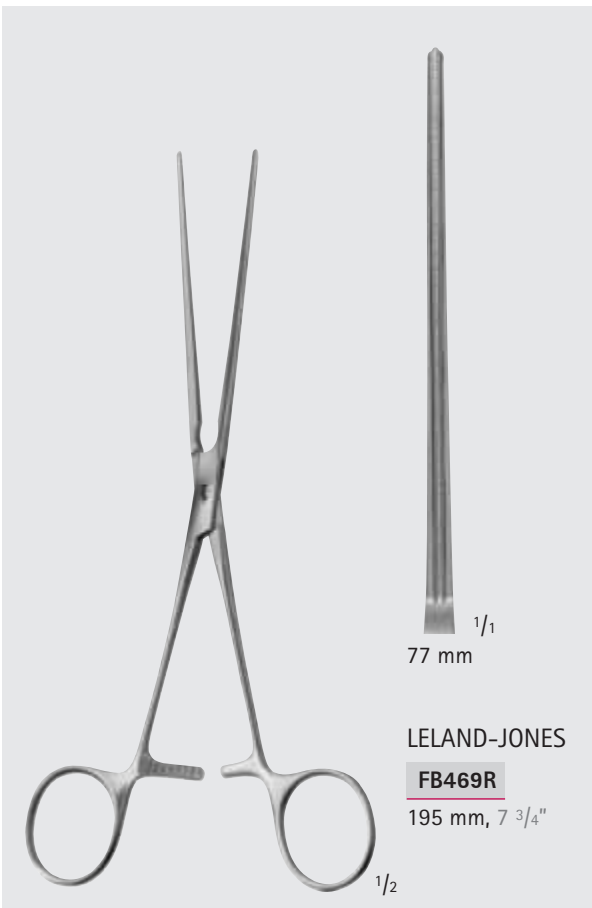
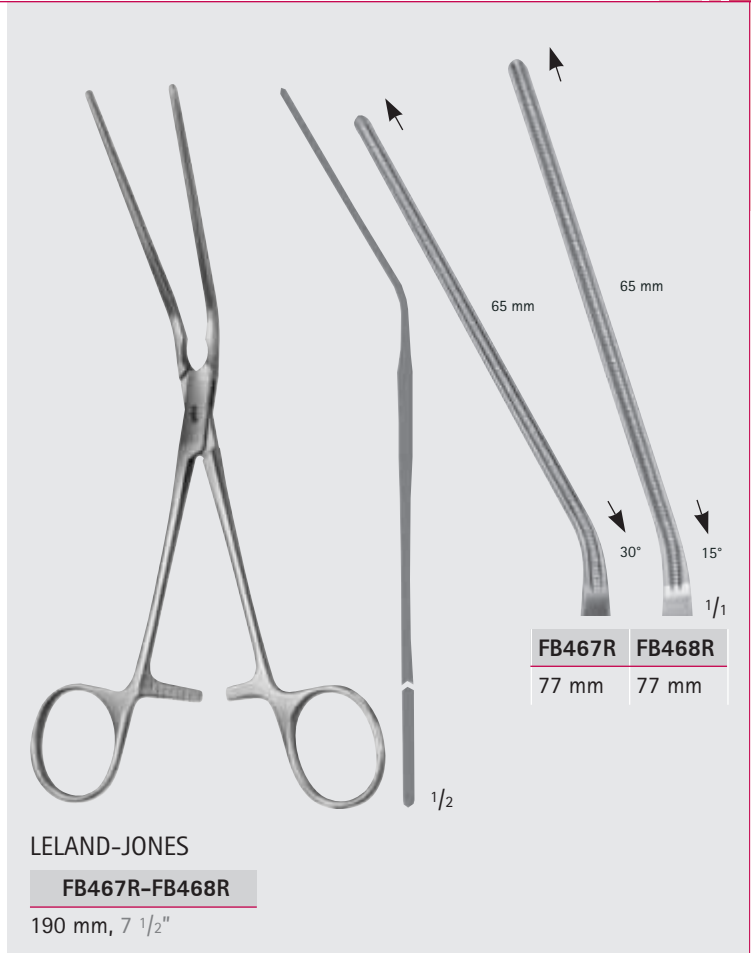
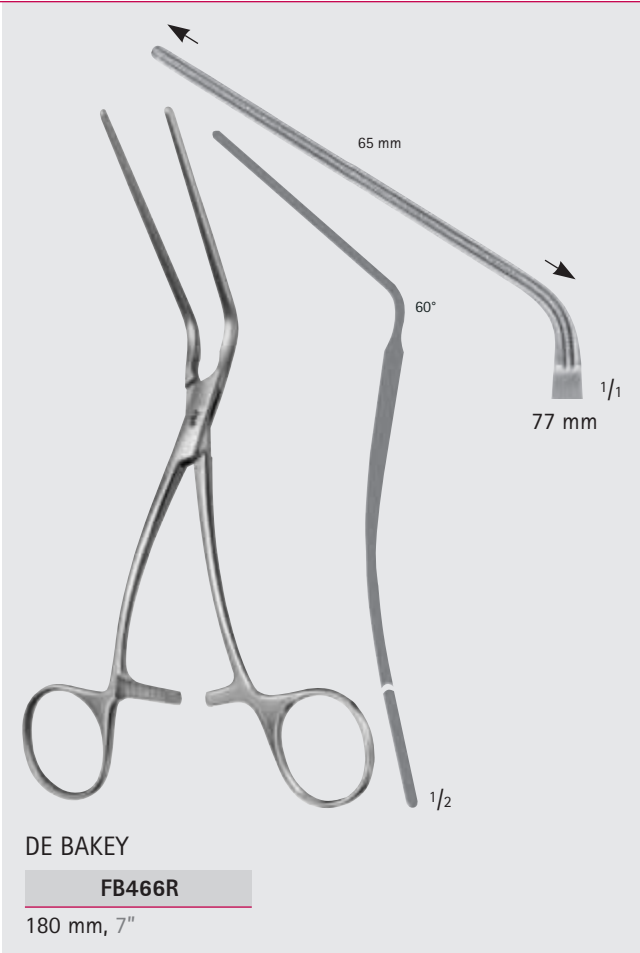

MILLIMETERS

# Herz- und Gefäß-Chirurgie – Cardiovascular Surgery

Anastomosenklemmen

Anastomosis Clamps

DE BAKEY Zahnung

**AIRAUMATA**<sup>®</sup>

Toothing DE BAKEY

**FB**



WERTHEIM

**BJ581R**

250 mm, 10"



**FB956R**

255 mm

10"

**FB957R**

265 mm

10 1/2"

**FB958R**

275 mm

10 3/4"

DICK

**FB956R-FB958R**



DE BAKEY Zahnung

# Herz- und Gefäß-Chirurgie – Cardiovascular Surgery

Mehrzweckklemmen

Multi-Purpose-Clamps

Toothing DE BAKEY AIRAUMATA®

FB

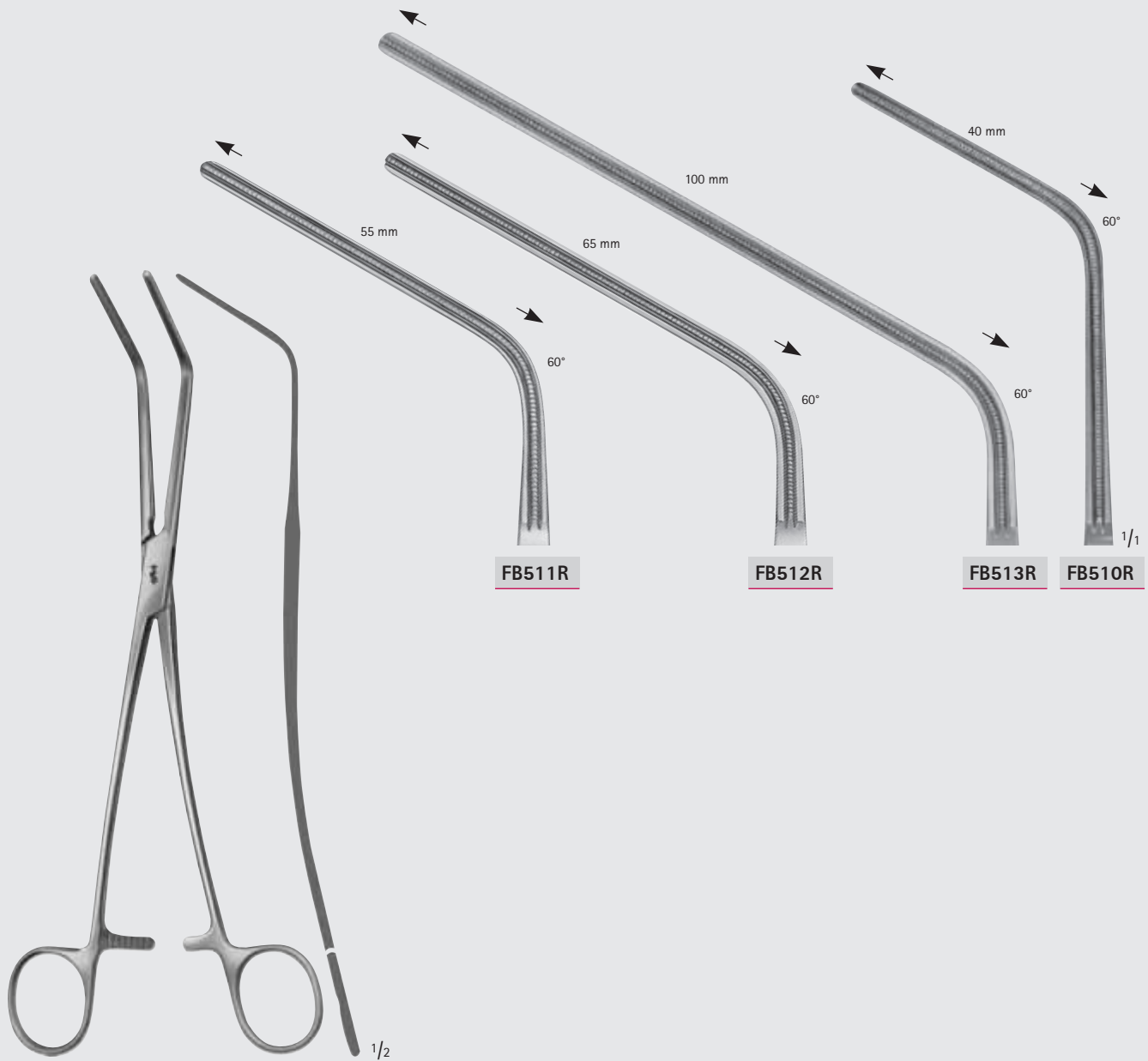

DE BAKEY

	FB511R	FB512R	FB513R	FB510R
Gesamtlänge:	230 mm	280 mm	305 mm	240 mm
Total Length:	9"	11"	12"	9 1/2"
Mauillänge:	85 mm	100 mm	135 mm	93 mm
Jaw length:	3 3/8"	4"	5 1/8"	3 3/4"



MILLIMETERS

# Herz- und Gefäß-Chirurgie – Cardiovascular Surgery

Mehrweckklemmen  
Multi-Purpose-Clamps

DE BAKEY Zahnung

ARAUMATA®

Toothing DE BAKEY

FB

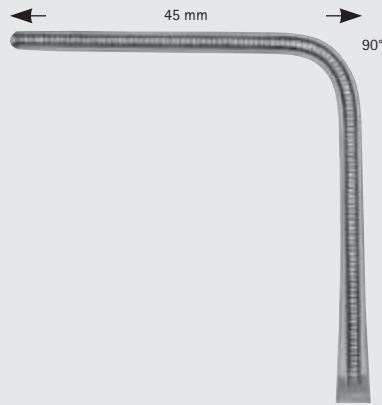

FB515R

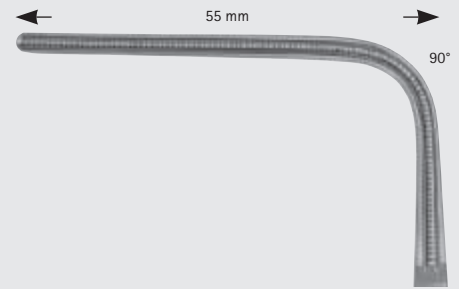

FB516R

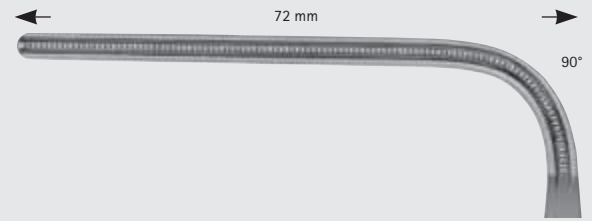

FB517R

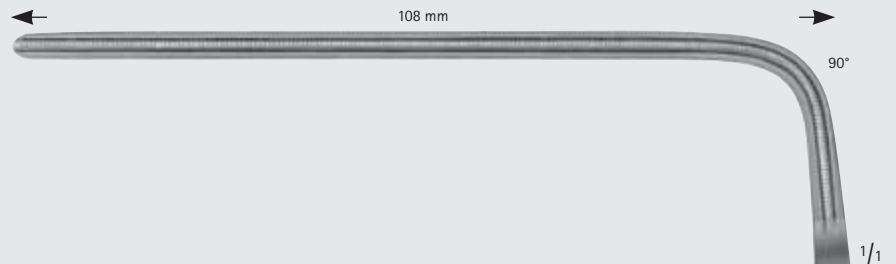

FB518R



DE BAKEY

	FB515R	FB516R	FB517R	FB518R
Gesamtlänge:	225 mm	210 mm	255 mm	275 mm
Total Length:	9"	8 1/4"	10"	10 3/4"
Maullänge:	93 mm	85 mm	92 mm	134 mm
Jaw length:	3 3/4"	3 3/8"	3 5/8"	5 1/4"



DE BAKEY Zahnung

# Herz- und Gefäß-Chirurgie – Cardiovascular Surgery

Aortaklemmen

Toothing DE BAKEY

**AIRAUMATA®**

Ascending Aorta Cross Clamps

**FB**

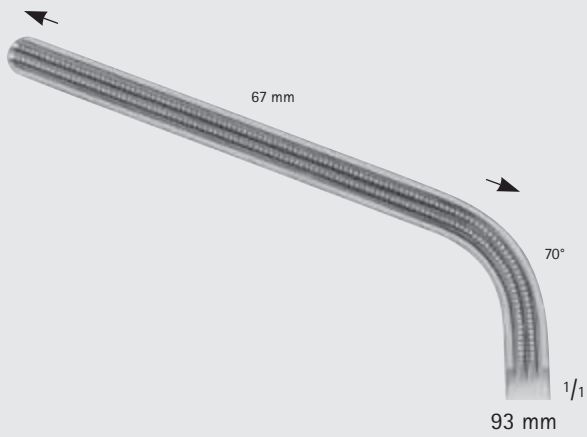

MORRIS

**FB493R**

175 mm, 7"

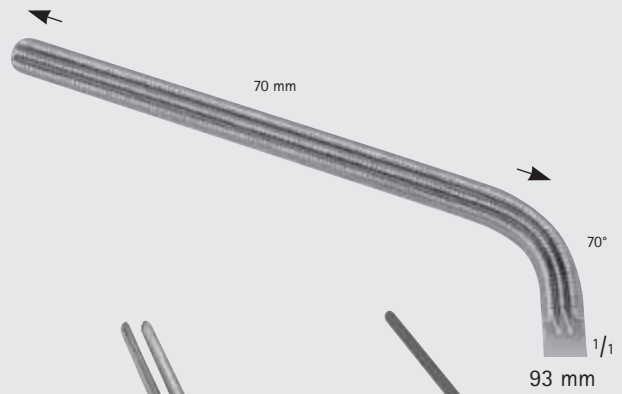

DE BAKY (MORRIS MODIF.)

**FB494R**

240 mm, 9"

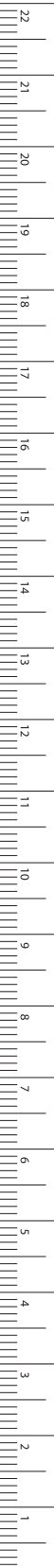

# Herz- und Gefäß-Chirurgie – Cardiovascular Surgery

Bronchusklemmen

Bronchus Clamps

DE BAKEY Zahnung

APRAUMATA®

Toothing DE BAKEY

FB



LEES

**FB573R**

220 mm, 8 3/4"



LEES

**FB574R**

245 mm, 9 3/4"





DE BAKEY Zahnung

Toothing DE BAKEY

ARAUMATA®

# Herz- und Gefäß-Chirurgie – Cardiovascular Surgery

Aorta-Aneurysma-Klemmen

Aorta-Aneurysm-Clamps

FB

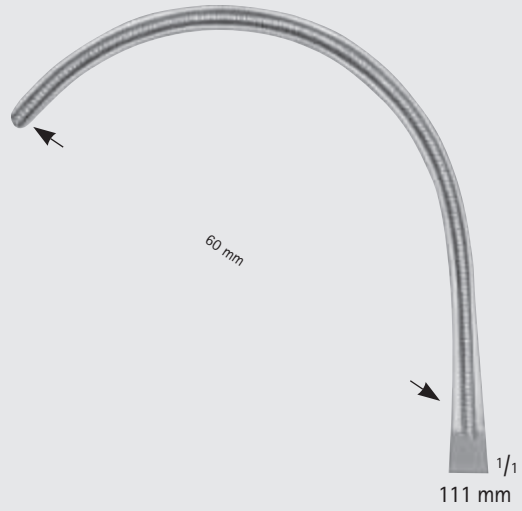
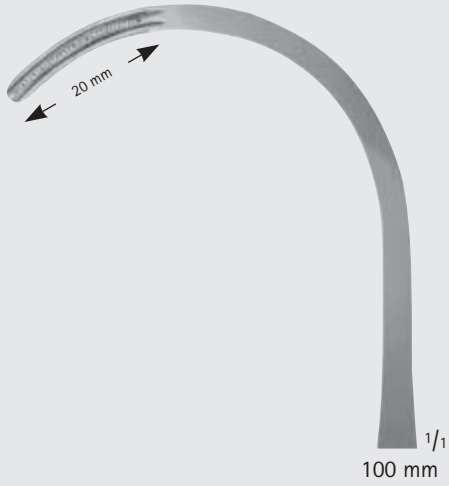

DE BAKEY (SEMB MODIF.)

**FB482R**

265 mm, 10 1/2"



DE BAKEY

**FB481R**

270 mm, 10 3/4"

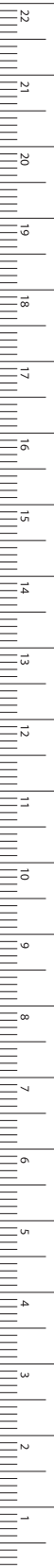

# Herz- und Gefäß-Chirurgie – Cardiovascular Surgery

Aorta-Aneurysma-Klemmen

Aorta-Aneurysm-Clamps

DE BAKEY Zahnung

APRAUMATA®

Toothing DE BAKEY

FB

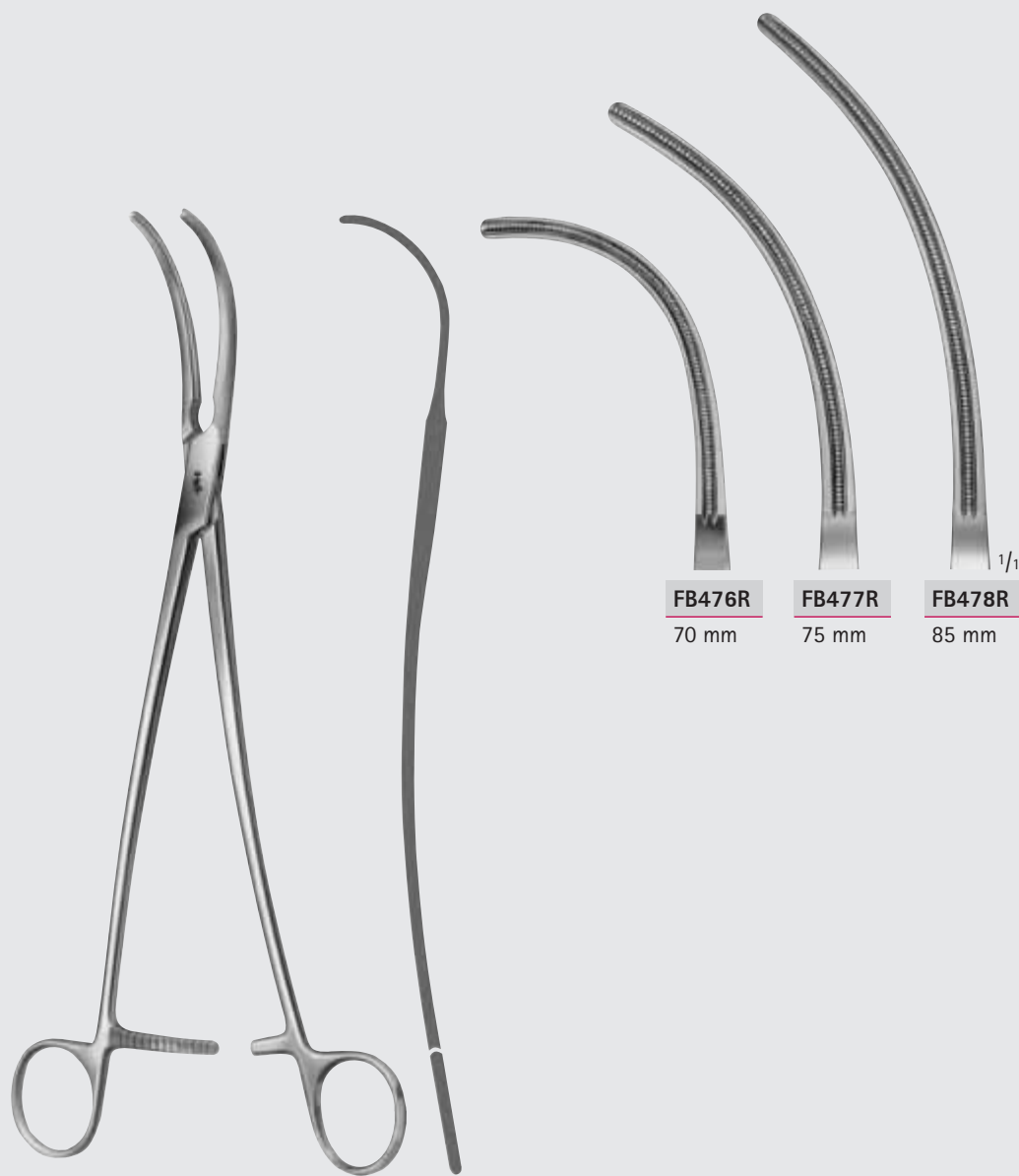

**FB476R**  
70 mm

**FB477R**  
75 mm

**FB478R**  
85 mm

DE BAKEY

<b>FB476R</b>	255 mm	10"
<b>FB477R</b>	265 mm	10 1/2"
<b>FB478R</b>	280 mm	11"



DE BAKEY Zahnung

Toothing DE BAKEY

**ARAUMATA®**

## Herz- und Gefäß-Chirurgie – Cardiovascular Surgery

Aorta-Aneurysma-Klemmen

Aorta-Aneurysm-Clamps

2:3 Zahnreihen  
2:3 Teeth rows

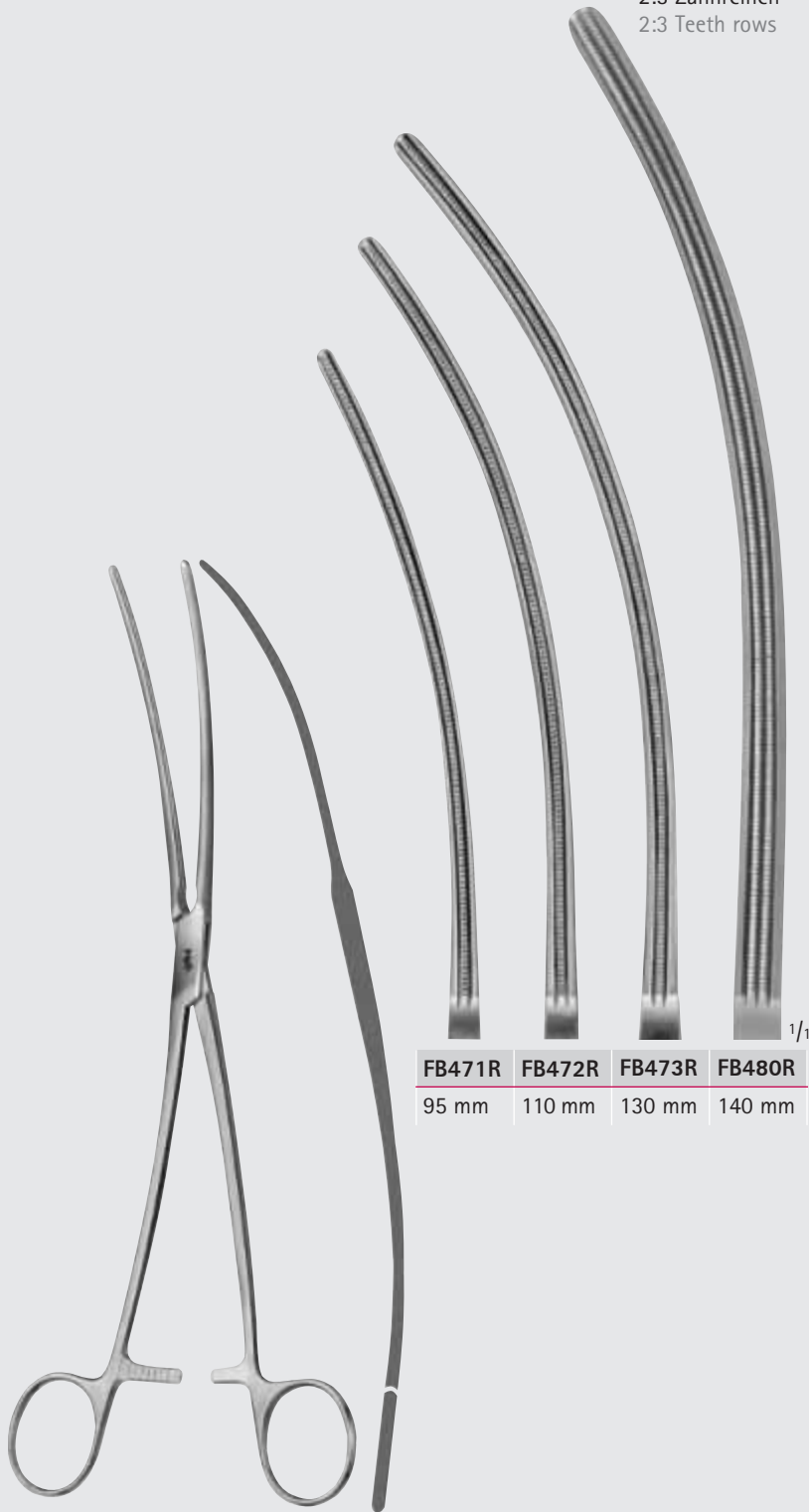

FB471R	FB472R	FB473R	FB480R
95 mm	110 mm	130 mm	140 mm

DE BAKEY

FB471R	250 mm	10"
FB472R	300 mm	12"
FB473R	315 mm	12 1/2"
FB480R	330 mm	13"

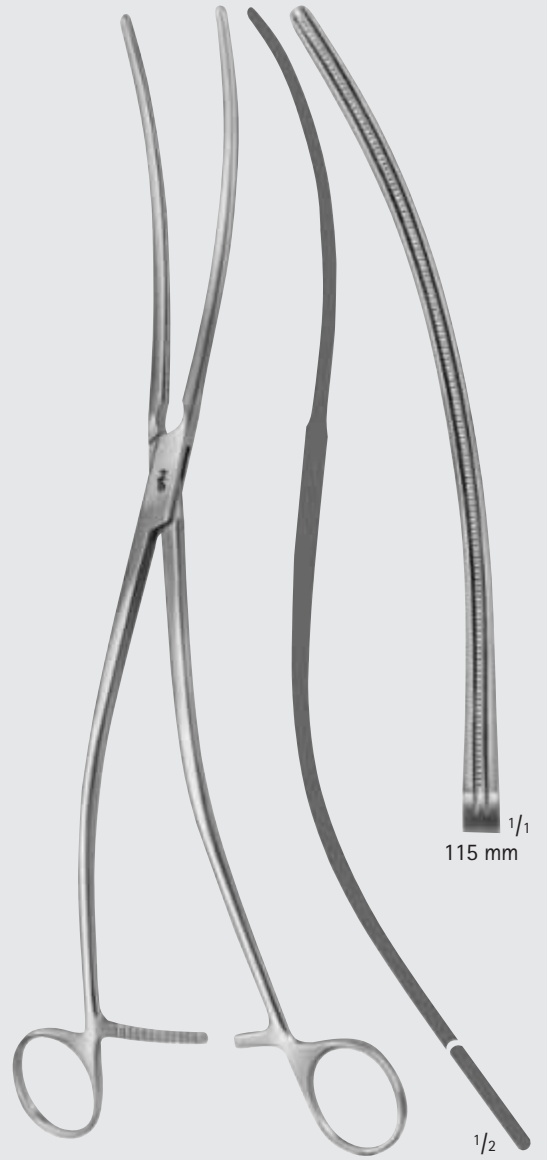

115 mm

DE BAKEY

<b>FB475R</b>
300 mm, 12"

**FB**

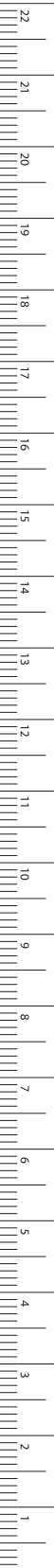

MILLIMETERS

# Herz- und Gefäß-Chirurgie – Cardiovascular Surgery

Aortaklemmen

Aorta Clamps

DE BAKEY Zahnung

APRAUMATA®

Toothing DE BAKEY

FB

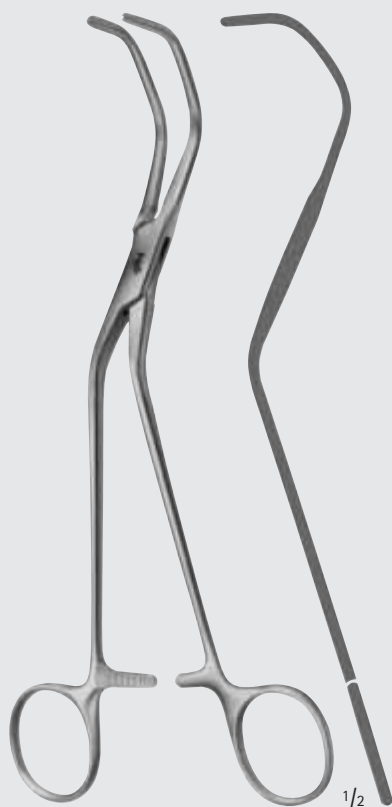
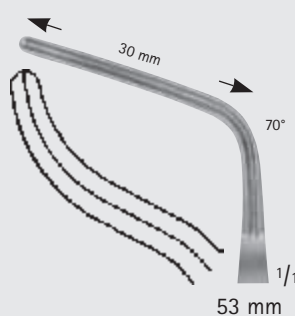

DIETRICH

FB525R

210 mm, 8 1/4"



SUBRAMANIAN (MODIF.)

FB578R

155 mm, 6"



DE BAKEY Zahnung

Toothing DE BAKEY

ARAUMATA®

# Herz- und Gefäß-Chirurgie – Cardiovascular Surgery

Aortaklemmen

Aorta Clamps

FB

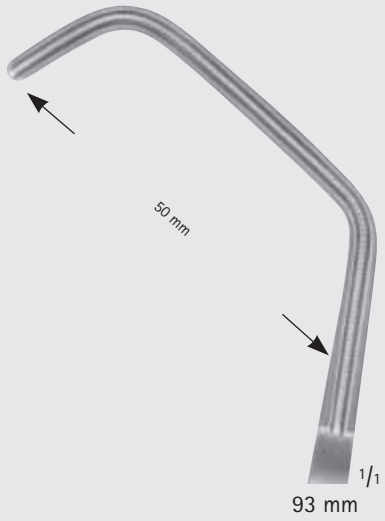

OCHSNER

**FB495R**

260 mm, 10 1/4"

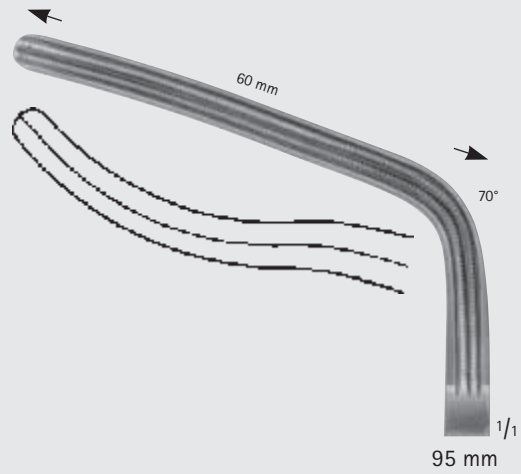

DE BAKY

**FB576R**

265 mm, 10 1/2"

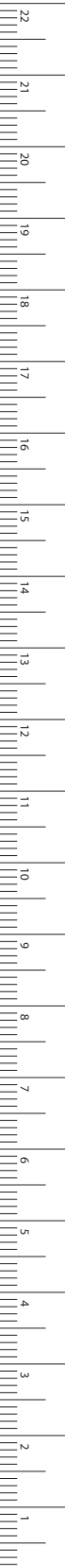

# Herz- und Gefäß-Chirurgie – Cardiovascular Surgery

Aorta-Anastomosenklemmen

Aorta-Anastomosis Clamps

DE BAKEY Zahnung



APRAUMATA®

Toothing DE BAKEY

FB

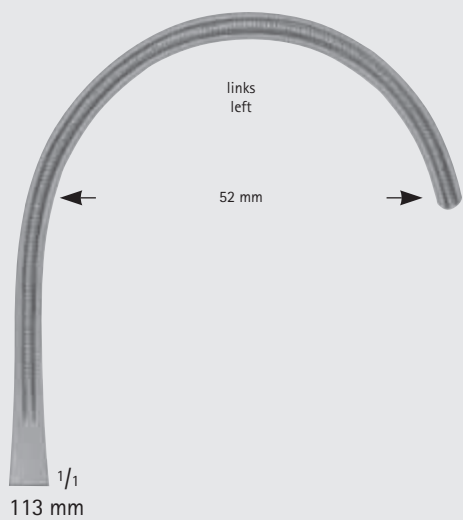

WEBER

FB488R

260 mm, 10 1/4"

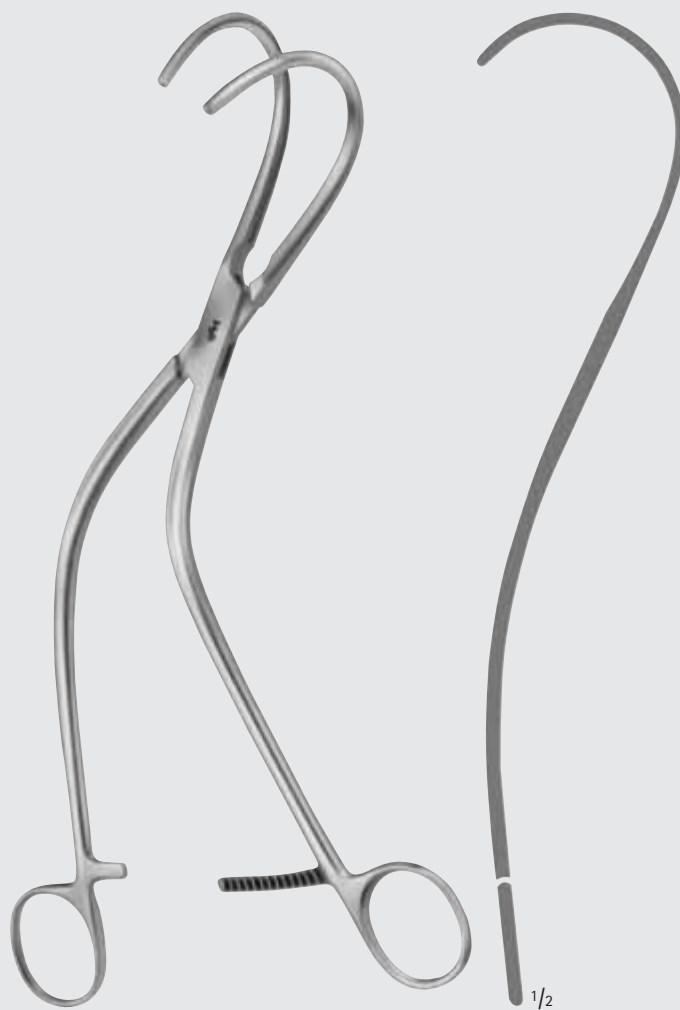
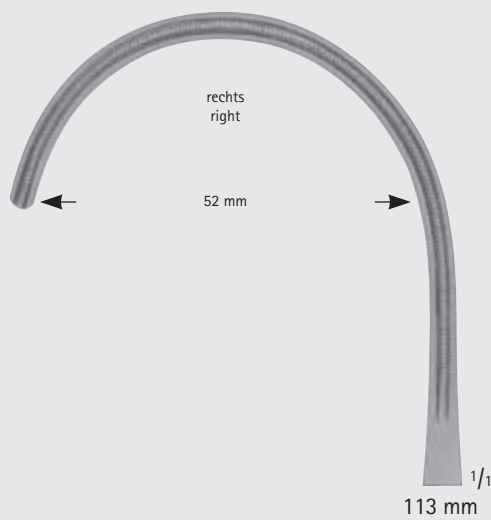

WEBER

FB489R

260 mm, 10 1/4"



DE BAKEY Zahnung

Toothings DE BAKEY

ARAUMATA®

# Herz- und Gefäß-Chirurgie – Cardiovascular Surgery

Aorta-Anastomosenklemmen

Aorta-Anastomosis Clamps

FB

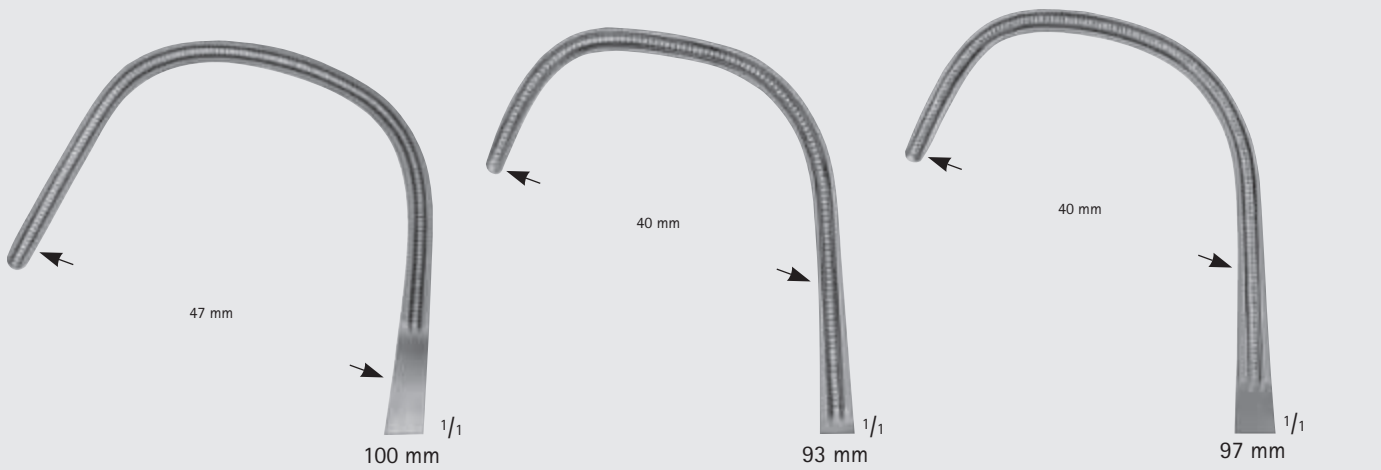

LAMBERT-KAY

**FB492R**

210 mm, 8 1/4"



LAMBERT-KAY

**FB490R**

215 mm, 8 1/2"



DE BAKEY (MOD. LAMBERT)

**FB491R**

255 mm, 10"



MILLIMETERS

# Herz- und Gefäß-Chirurgie – Cardiovascular Surgery

Bulldogklemmen mit Ringgriffen  
Ring Handle Bulldog Clamps

COOLEY Zahnung

ARAUMATA®

Toothing COOLEY

FB

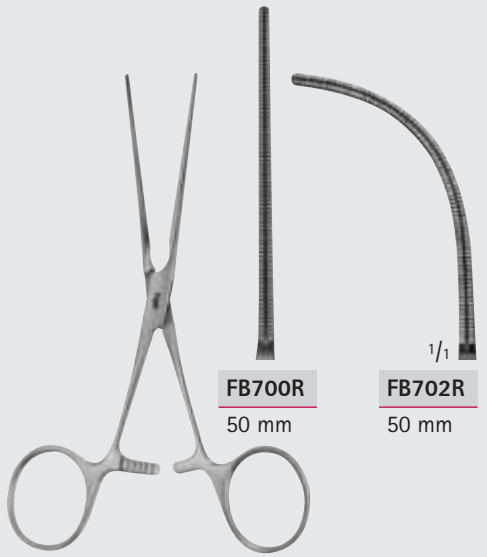

**FB700R**  
50 mm

**FB702R**  
50 mm

COOLEY

<b>FB700R</b>	125 mm	5"
<b>FB702R</b>	115 mm	4 1/2"

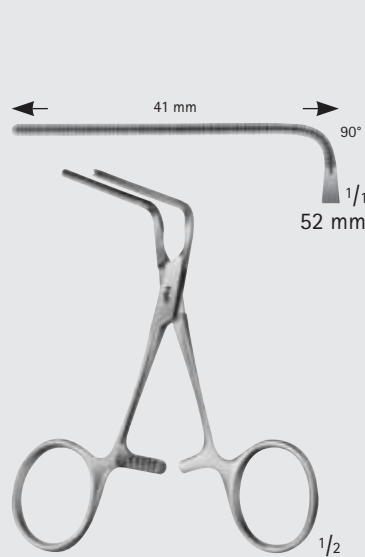

COOLEY

**FB707R**

100 mm, 4"

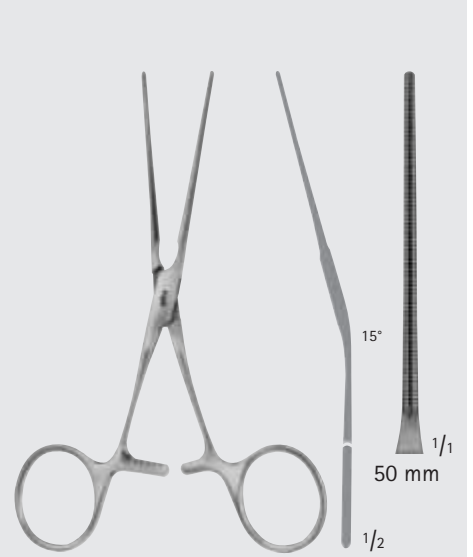

COOLEY

**FB701R**

125 mm, 5"

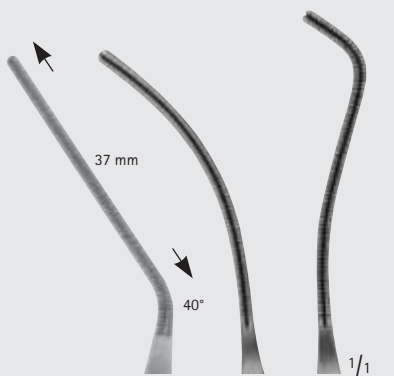

<b>FB704R</b>	<b>FB703R</b>	<b>FB706R</b>
50 mm	50 mm	52 mm

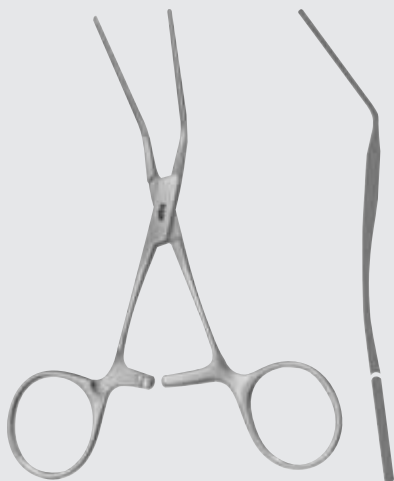

COOLEY

<b>FB704R</b>	120 mm	4 3/4"
<b>FB703R</b>	125 mm	5"
<b>FB706R</b>	125 mm	5"

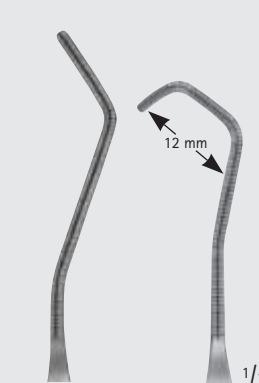

**FB705R**  
50 mm

**FB708R**  
50 mm



COOLEY

<b>FB705R</b>	120 mm	4 3/4"
<b>FB708R</b>	115 mm	4 1/2"





COOLEY Zahnung

Toothings COOLEY

ARAUMATA®

# Herz- und Gefäß-Chirurgie – Cardiovascular Surgery

Bulldogklemmen mit Ringgriffen

Ring Handle Bulldog Clamps

FB

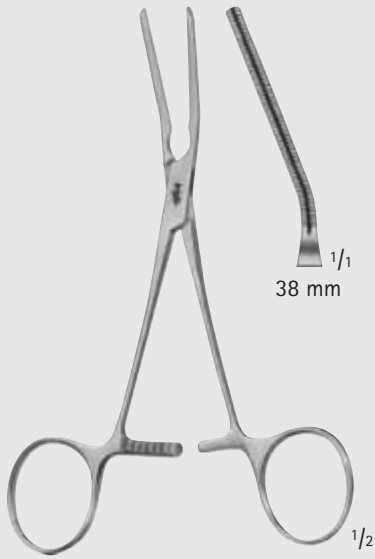

COOLEY

**FB741R**

145 mm, 5 3/4"



COOLEY

**FB742R**

140 mm, 5 1/2"

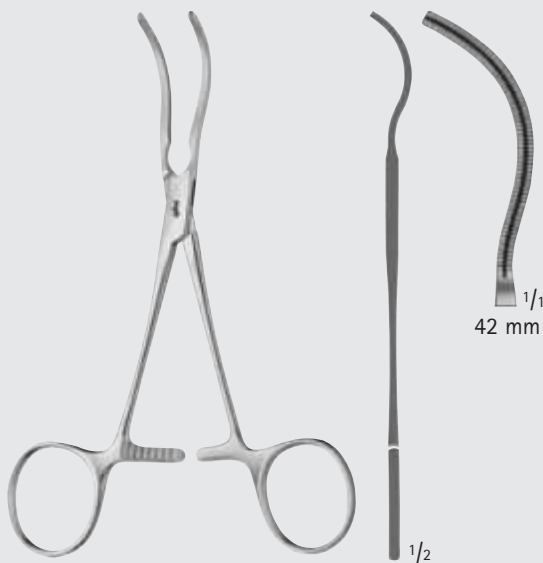

COOLEY

**FB743R**

145 mm, 5 3/4"



SATINSKY

**MB613R**

140 mm, 5 1/2"

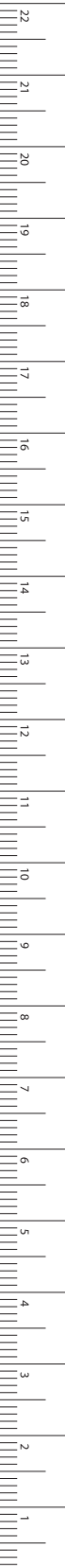

MILLIMETERS

# Herz- und Gefäß-Chirurgie – Cardiovascular Surgery

Anastomosenklemmen, Kinder-Modelle

Anastomosis Clamps, Pediatric Patterns

COOLEY Zahnung

ARAUMATA®

Toothing COOLEY

FB

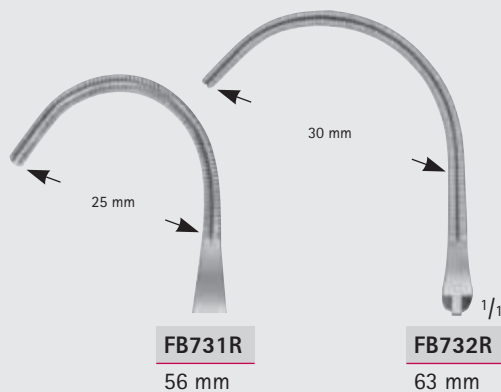

COOLEY-BECK

<b>FB731R</b>	150 mm	6"
<b>FB732R</b>	155 mm	6"

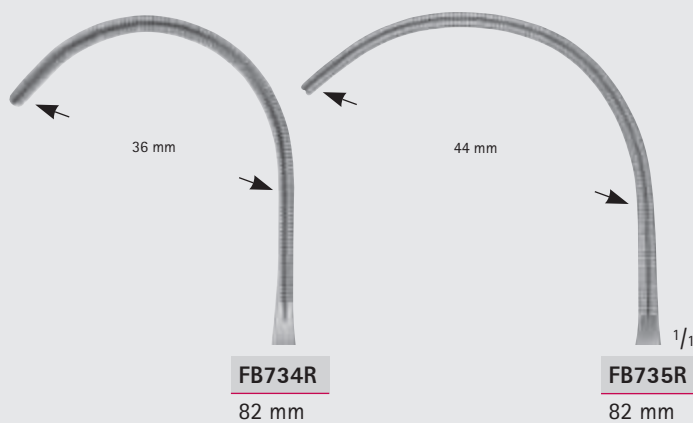

COOLEY

<b>FB734R-FB735R</b>	170 mm, 6 3/4"
----------------------	----------------



COOLEY Zahnung

Toothing COOLEY

ARAUMATA®

# Herz- und Gefäß-Chirurgie – Cardiovascular Surgery

Anastomosenklemmen, Kinder-Modelle

Anastomosis Clamps, Pediatric Patterns

FB

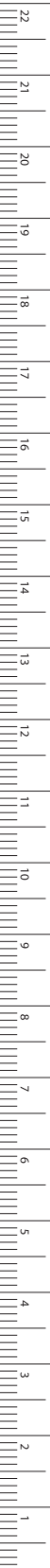

MILLIMETERS

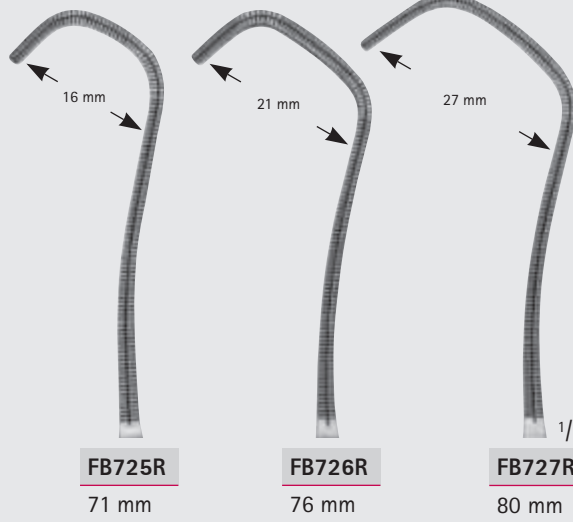

**FB725R**  
71 mm

**FB726R**  
76 mm

**FB727R**  
80 mm

## DERRA-COOLEY

<b>FB725R</b>	170 mm	6 3/4"
<b>FB726R</b>	175 mm	7"
<b>FB727R</b>	175 mm	7"

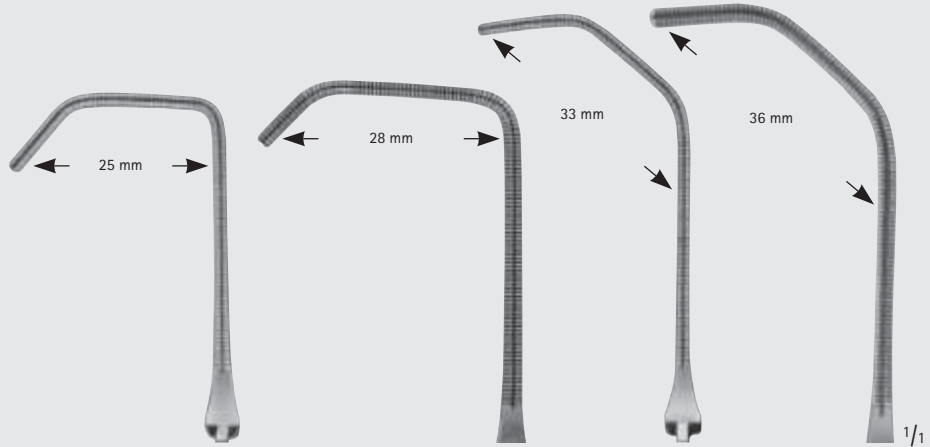

**FB721R**  
72 mm

**FB722R**  
76 mm

**FB723R**  
72 mm

**FB724R**  
76 mm

## COOLEY

<b>FB721R</b>	165 mm	6 1/2"
<b>FB722R</b>	165 mm	6 1/2"
<b>FB723R</b>	175 mm	7"
<b>FB724R</b>	180 mm	7"

# Herz- und Gefäß-Chirurgie – Cardiovascular Surgery

Mehrzweckklemmen, Kinder-Modelle  
Multi-Purpose Clamps, Pediatric Patterns

COOLEY Zahnung

ARAIMATA®

Toothing COOLEY

FB

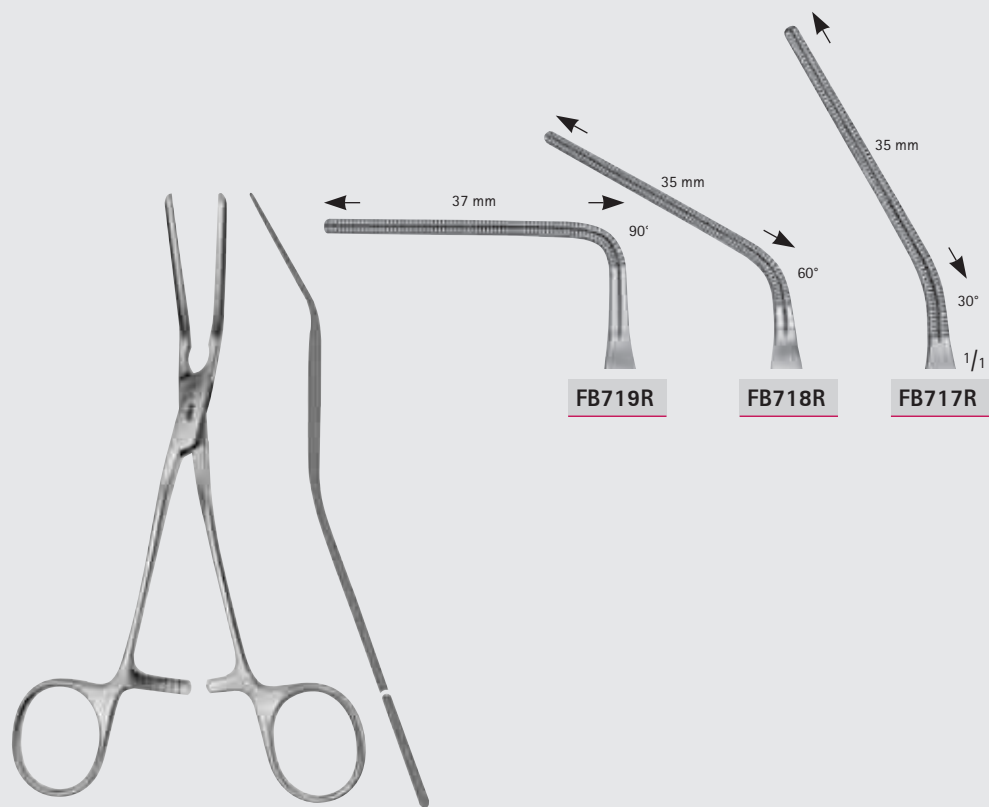

COOLEY

<b>FB719R</b>	150 mm	6"
<b>FB718R</b>	160 mm	6 1/4"
<b>FB717R</b>	165 mm	6 1/2"



COOLEY Zahnung

Toothings COOLEY

ARAUMATA®

### Herz- und Gefäß-Chirurgie – Cardiovascular Surgery

Anastomosenklemmen, Mehrzweckklemmen  
Anastomosis Clamps, Multi-Purpose Clamps

FB

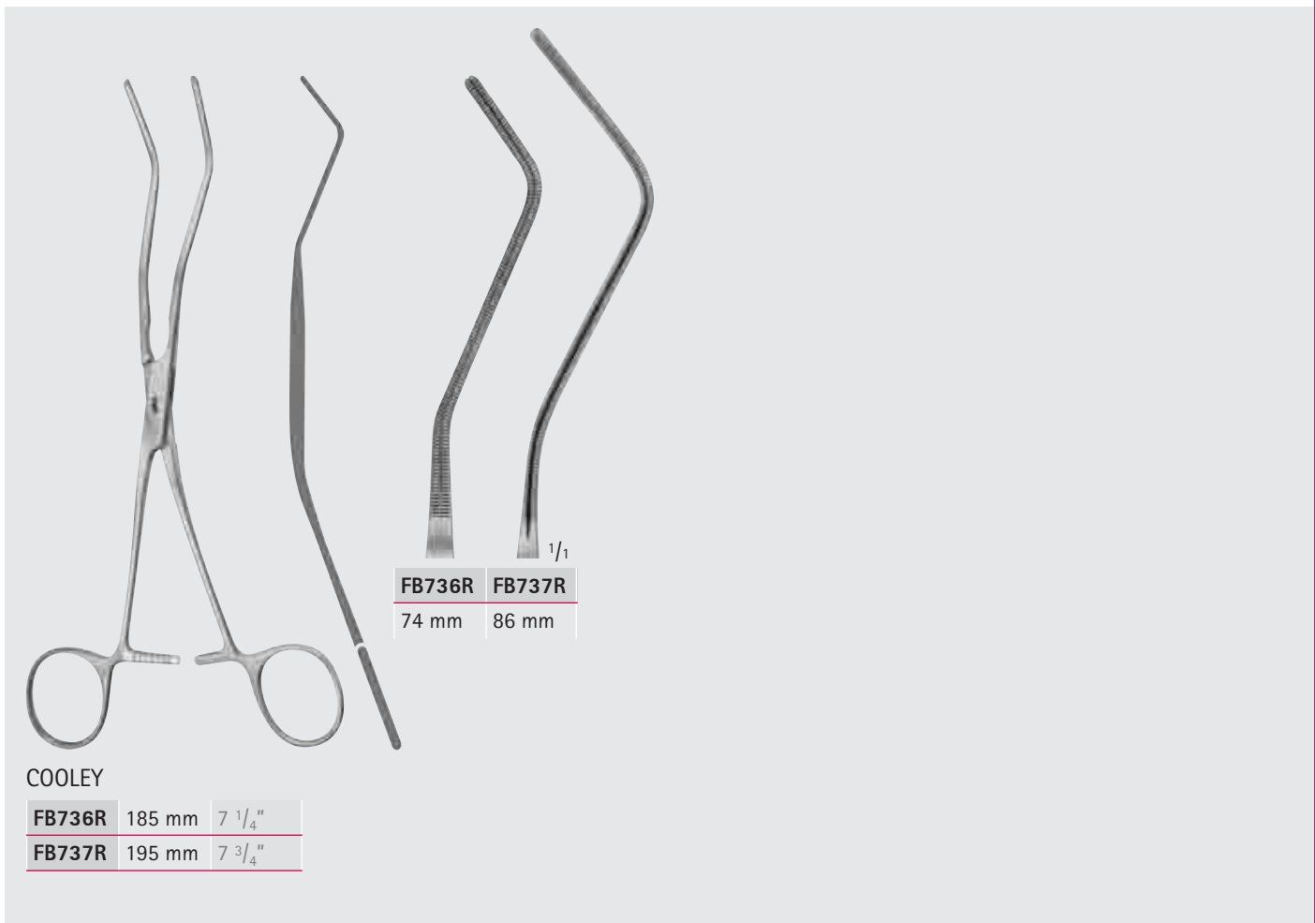
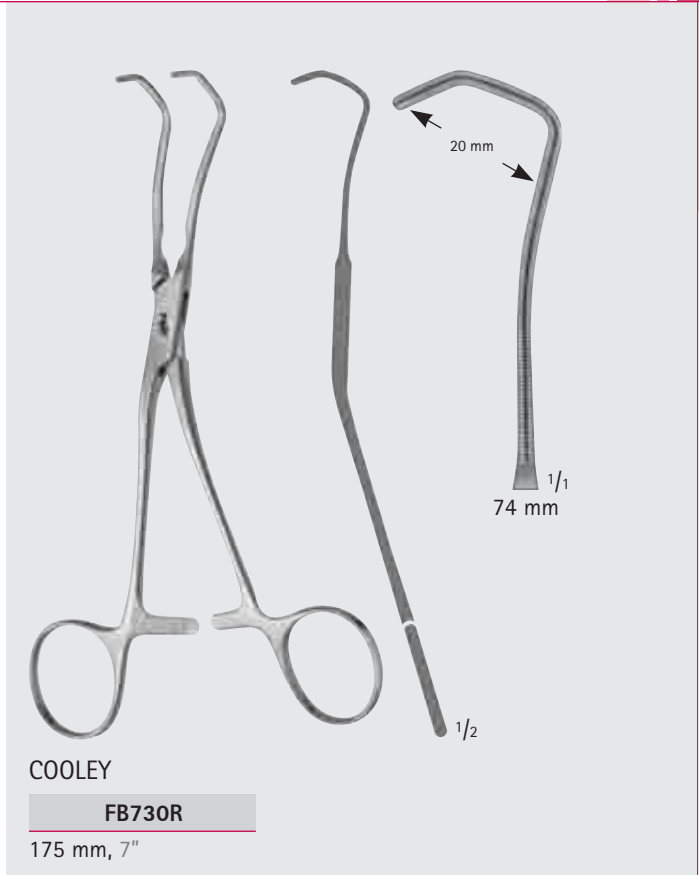
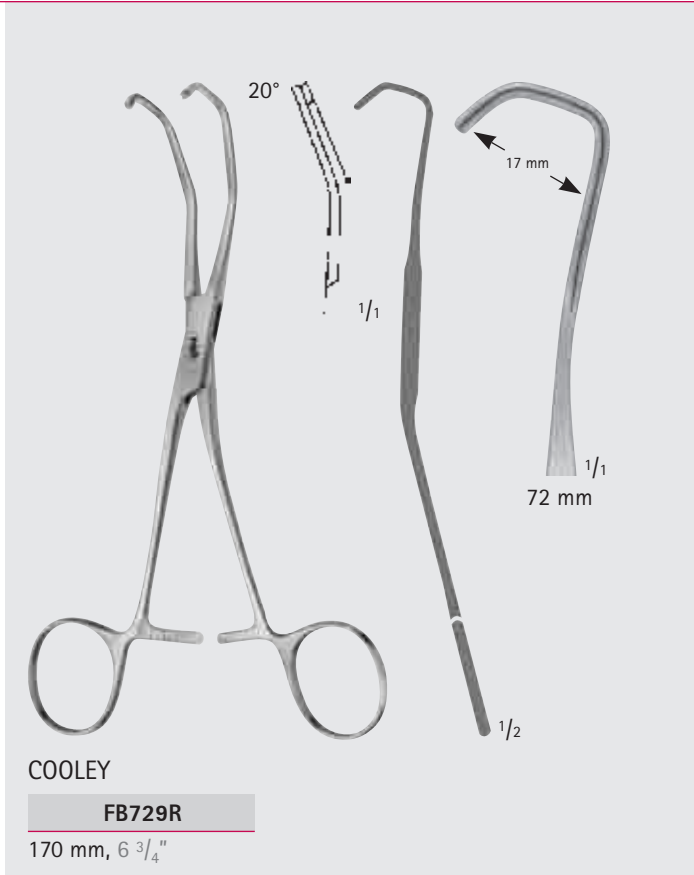

MILLIMETERS

# Herz- und Gefäß-Chirurgie – Cardiovascular Surgery

Patent-Ductusklemmen, Coarctationsklemmen, Kinder-Modelle

Patent-Ductus Clamps, Coarctations Clamps, Pediatric Patterns

APRAUMATA®

COOLEY Zahnung

Toothing COOLEY

FB

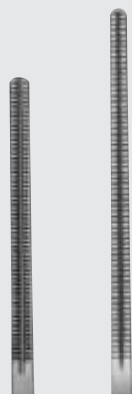

<b>FB710R</b>	<b>FB712R</b>
41 mm	52 mm



<b>FB713R</b>	<b>FB715R</b>
52 mm	63 mm

COOLEY

<b>FB710R</b>	160 mm	6 1/4"
<b>FB712R</b>	170 mm	6 3/4"
<b>FB713R</b>	180 mm	7"
<b>FB715R</b>	180 mm	7"

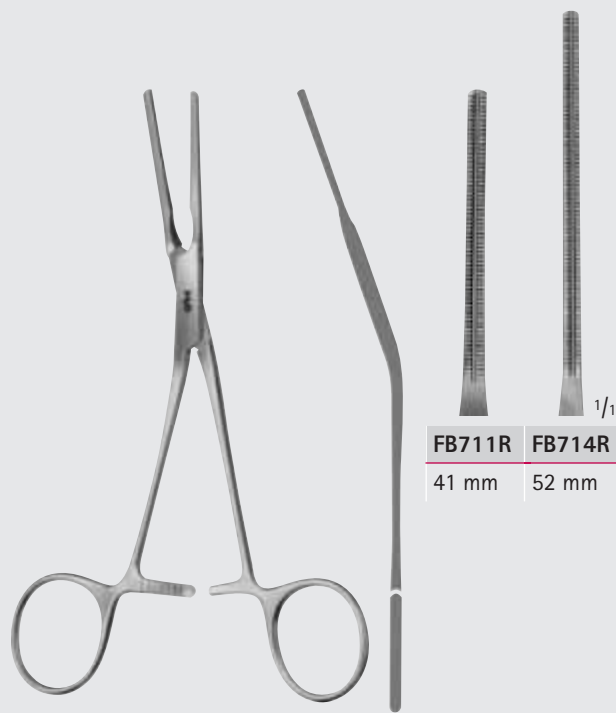

<b>FB711R</b>	<b>FB714R</b>
41 mm	52 mm

COOLEY

<b>FB711R</b>	160 mm	6 1/4"
<b>FB714R</b>	170 mm	6 3/4"



COOLEY Zahnung

Toothing COOLEY

**ARAUMATA®**

### Herz- und Gefäß-Chirurgie – Cardiovascular Surgery

Patent-Ductusklemmen, Coarctationsklemmen, Kinder-Modelle  
Patent-Ductus Clamps, Coarctations Clamps, Pediatric Patterns

**FB**

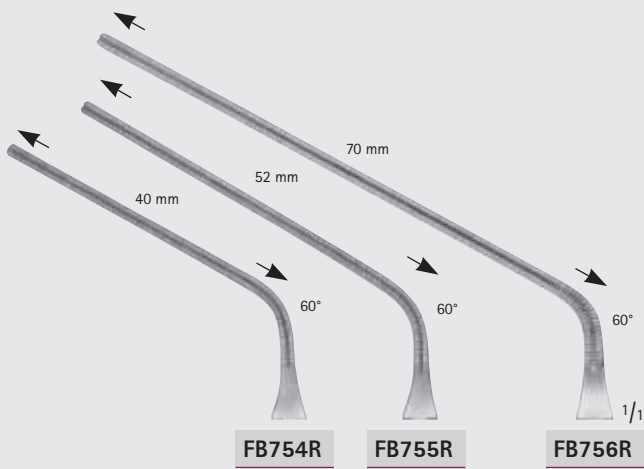

**FB754R**

**FB755R**

**FB756R**

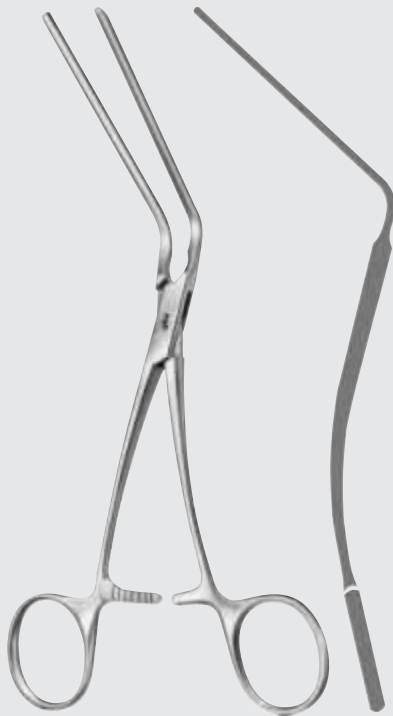

COOLEY

<b>FB754R</b>	165 mm	6 1/2"
<b>FB755R</b>	170 mm	6 3/4"
<b>FB756R</b>	185 mm	7 1/4"

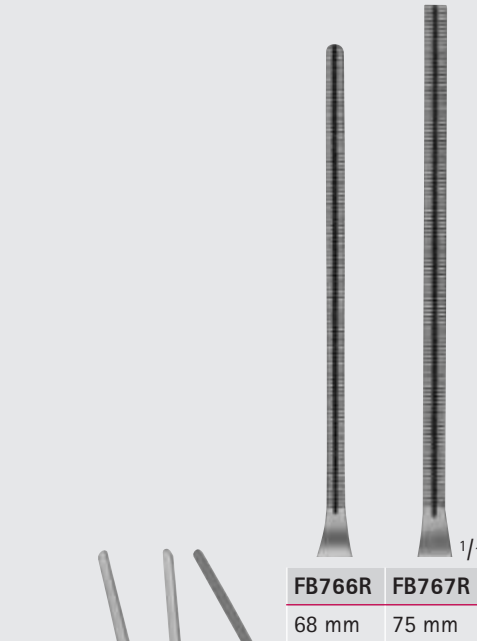

**FB766R**

**FB767R**

68 mm

75 mm

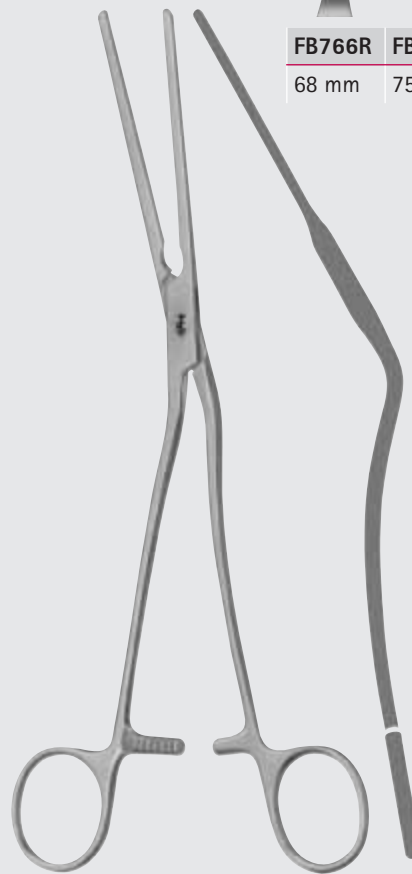

**FB766R** 225 mm 9"

**FB767R** 270 mm 10 3/4"

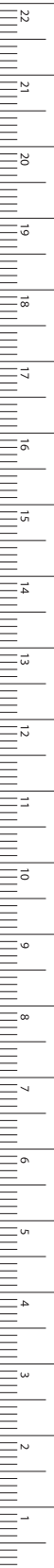

MILLIMETERS

# Herz- und Gefäß-Chirurgie – Cardiovascular Surgery

Anastomosenklemmen, Mehrzweckklemmen  
Anastomosis Clamps, Multi-Purpose Clamps

COOLEY Zahnung

APRAUMATA®

Toothing COOLEY

FB

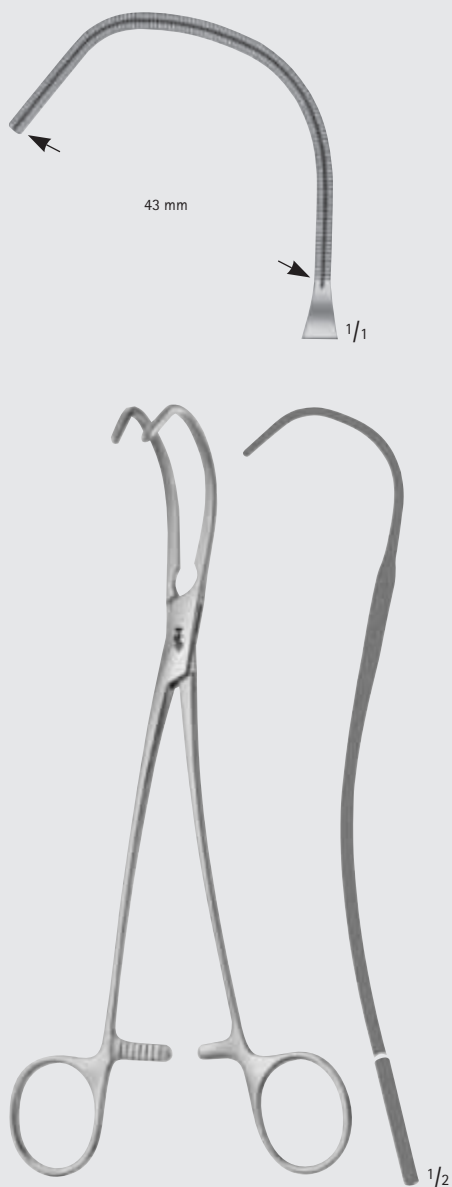

LEITZ

**FB795R**

205 mm, 8"

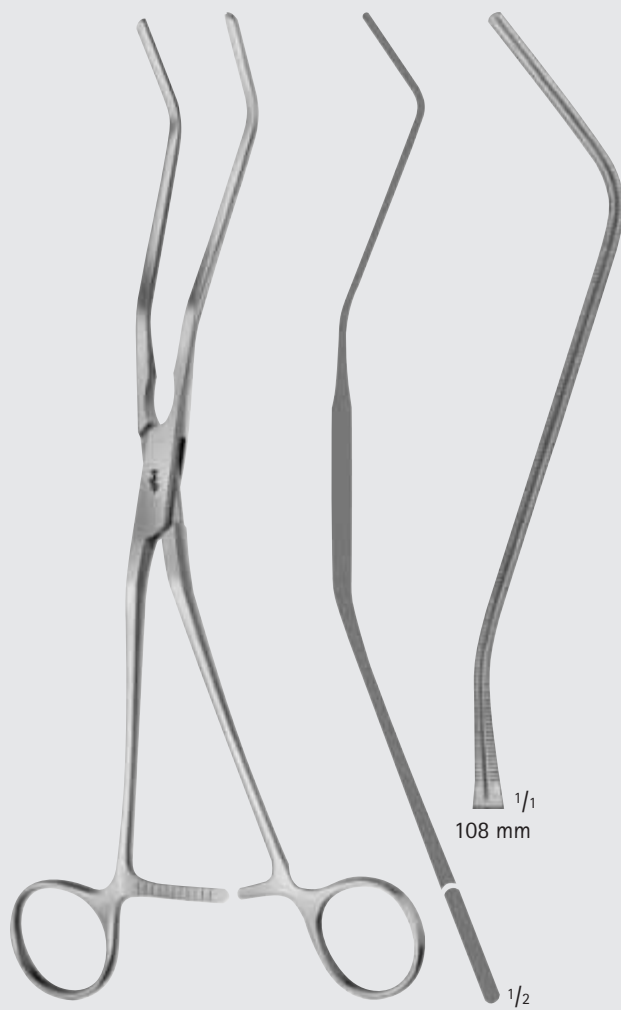

COOLEY

**FB738R**

260 mm, 10 3/4"





COOLEY Zahnung

Toothing COOLEY

APRAUMATA®

# Herz- und Gefäß-Chirurgie – Cardiovascular Surgery

Anastomosenklemmen

Anastomosis Clamps

FB

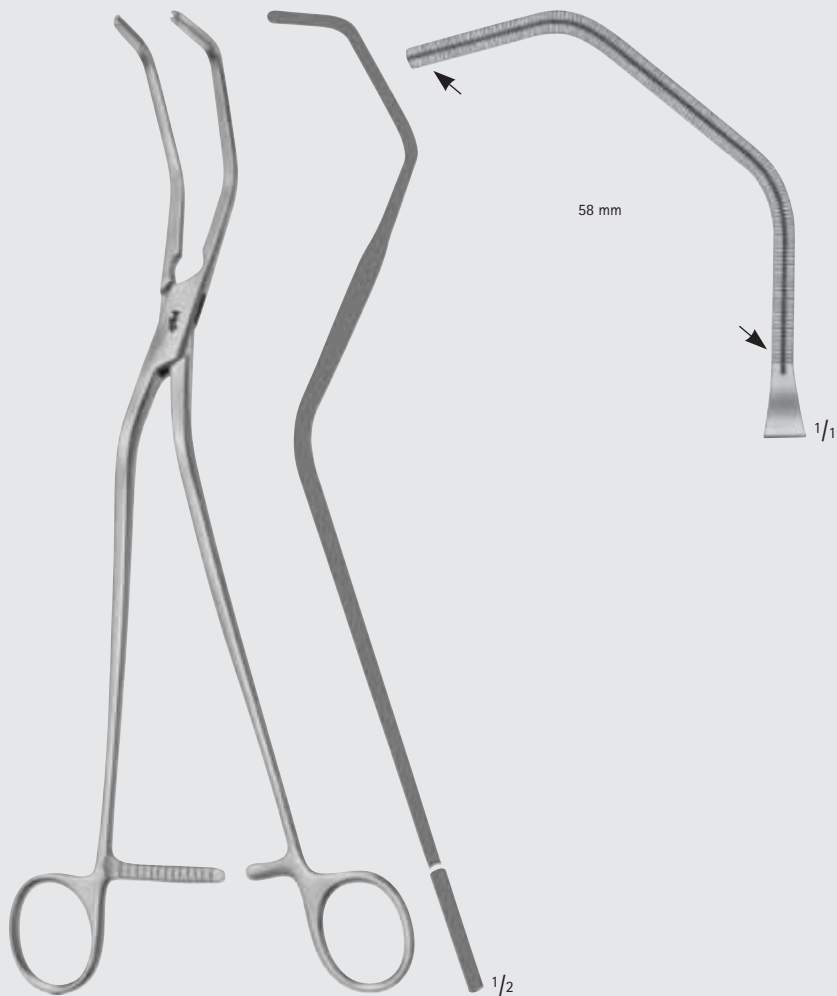

COOLEY

FB773R

260 mm, 10 1/4"



MILLIMETERS

# Herz- und Gefäß-Chirurgie – Cardiovascular Surgery

Anastomosenklemmen

Anastomosis Clamps

COOLEY Zahnung

APRAUMATA®

Toothing COOLEY

FB

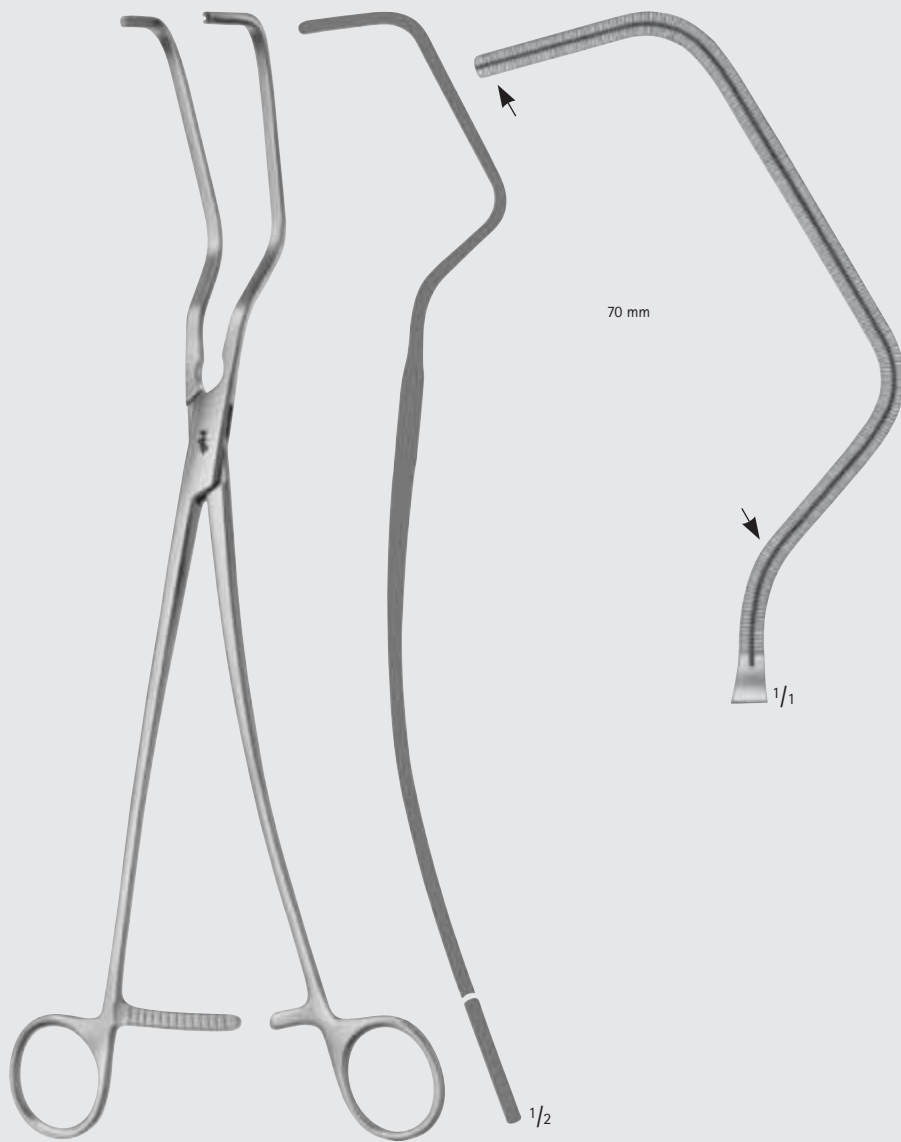

PARRY-COOLEY

**FB775R**

295 mm, 11 3/4"



COOLEY Zahnung

Toothing COOLEY

ARAUMATA®

# Herz- und Gefäß-Chirurgie – Cardiovascular Surgery

Anastomosenklemmen

Anastomosis Clamps

FB

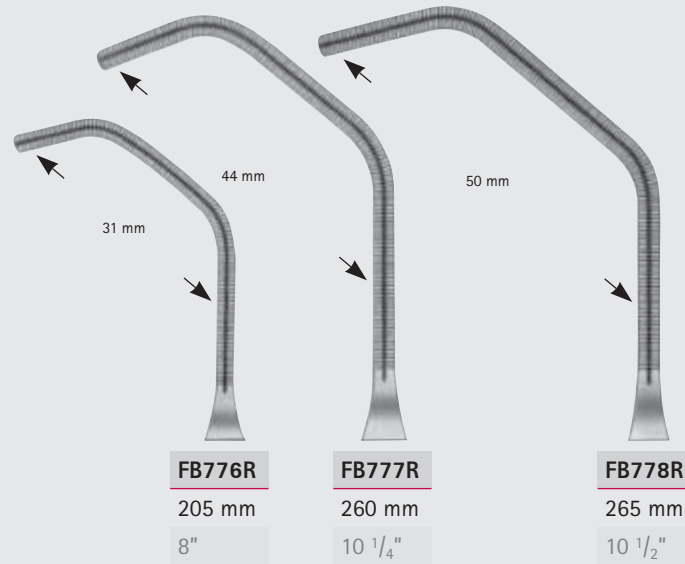

COOLEY

FB776R-FB780R

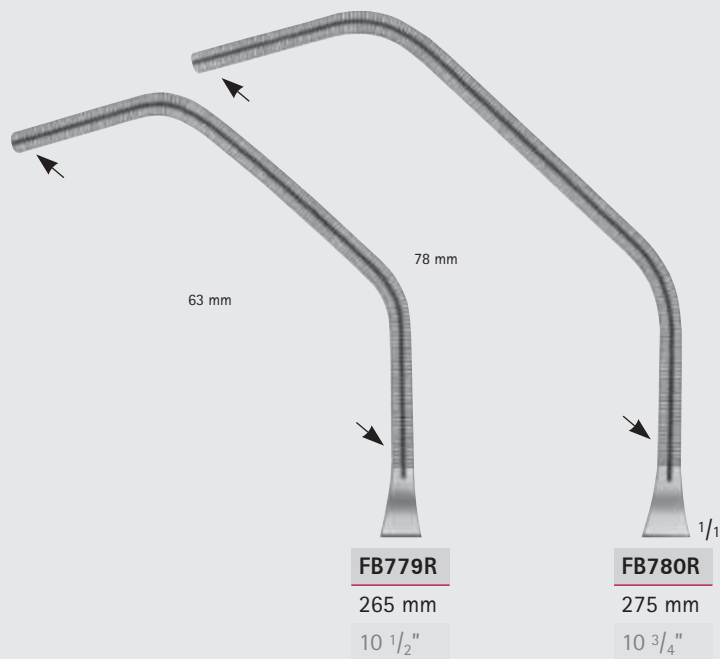

MILLIMETERS

Herz- und Gefäß-Chirurgie – Cardiovascular Surgery

Aortaklemme  
Aorta Clamp

COOLEY Zahnung

APRAUMATA®

Toothing COOLEY

FB

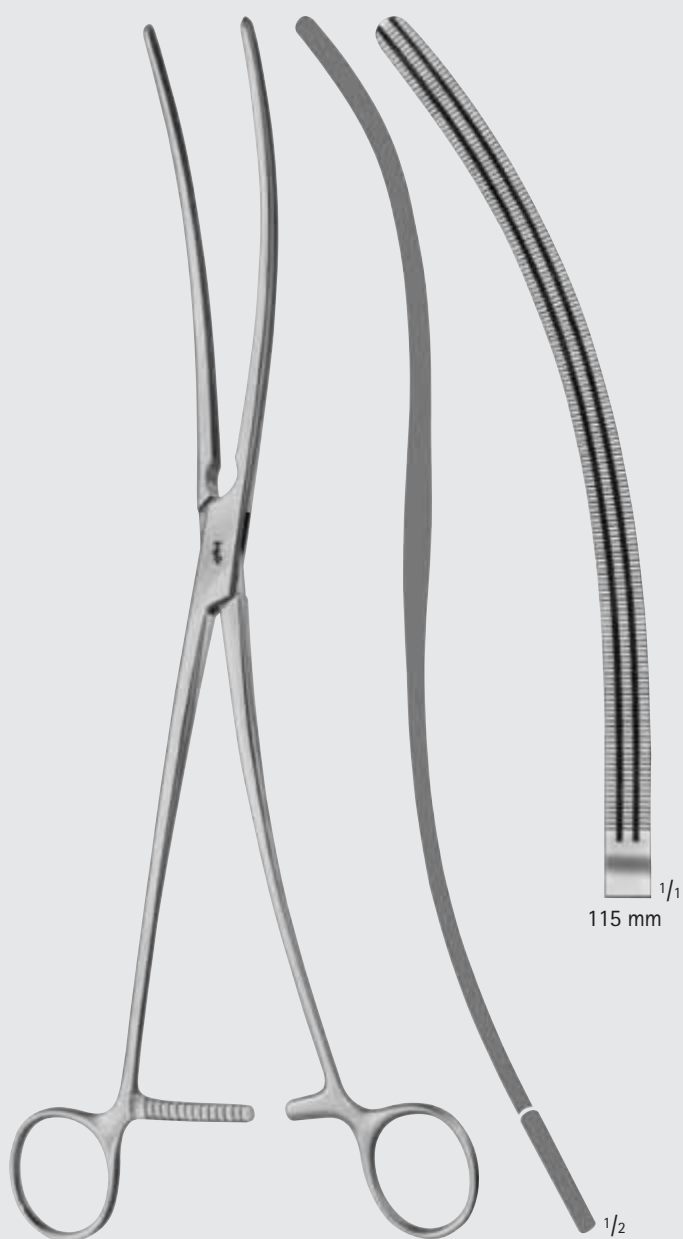

115 mm

1/2

COOLEY

FB764R

320 mm, 12 3/4"



COOLEY Zahnung

Toothings COOLEY

ARAUMATA®

# Herz- und Gefäß-Chirurgie – Cardiovascular Surgery

Mehrweckklemme  
Multi-Purpose Clamp

FB



COOLEY

FB765R

285 mm, 11 1/4"

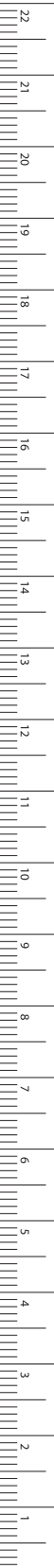

MILLIMETERS

# Herz- und Gefäß-Chirurgie – Cardiovascular Surgery

Mehrzweckklemmen  
Multi-Purpose Clamps

DE BAKEY Zahnung

APRAUMATA®

Toothing DE BAKEY

FB

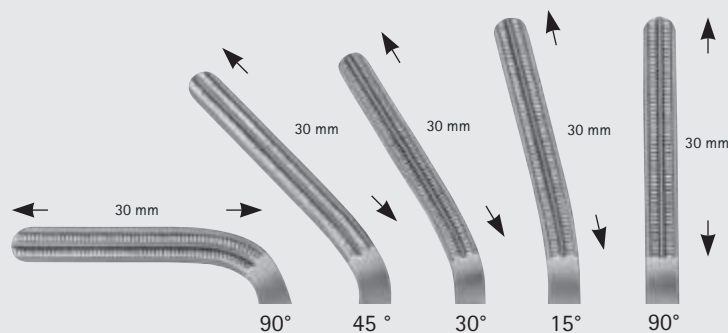

FC304R	FC303R	FC302R	FC301R	FC300R
130 mm	145 mm	150 mm	150 mm	150 mm
5 1/8"	5 3/4"	6"	6"	6"

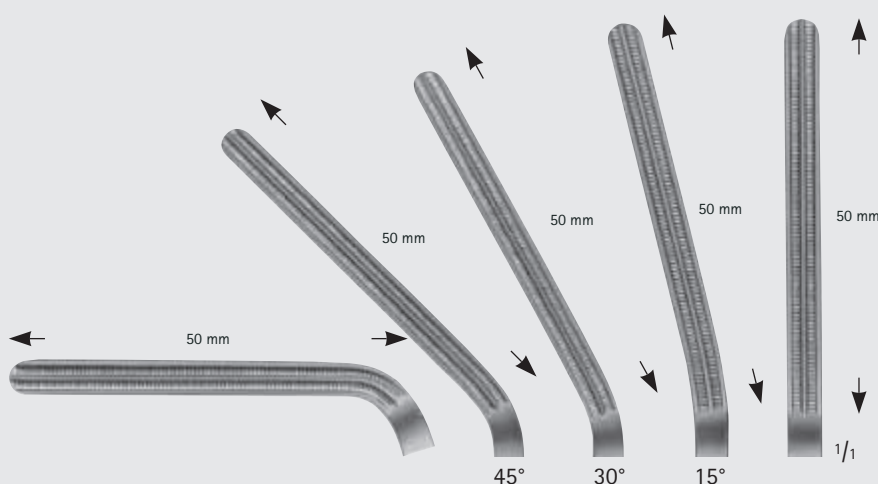

FC314R	FC313R	FC312R	FC311R	FC310R
135 mm	160 mm	170 mm	170 mm	170 mm
5 1/4"	6 1/4"	6 3/4"	6 3/4"	6 3/4"

FC300R-FC314R



DE BAKEY Zahnung



Toothings DE BAKEY

**ARAUMATA®**

## Herz- und Gefäß-Chirurgie – Cardiovascular Surgery

Gewebe- und Organfasszangen

Tissue- and Organ Grasping Forceps

**FB**

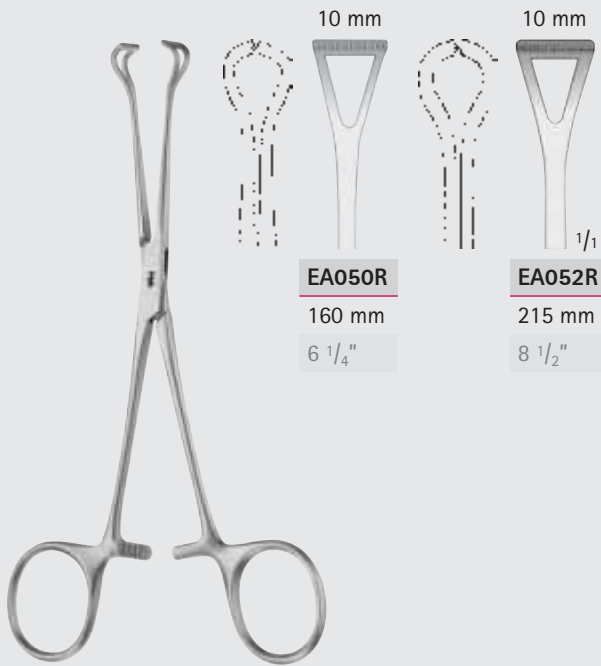

BABCOCK

**EA050R-EA052R**



BABCOCK

**FB936R**

220 mm, 8 3/4"



BABCOCK

**MD470**

240 mm, 9 1/2"

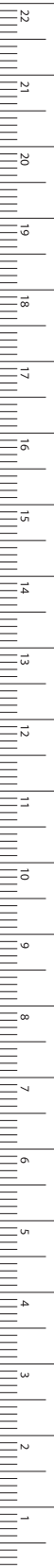

MILLIMETERS

# Herz- und Gefäß-Chirurgie – Cardiovascular Surgery

Gewebe- und Organfasszangen

Tissue- and Organ Grasping Forceps

DE BAKEY Zahnung



APRAUMATA®

Toothing DE BAKEY

FB



EA092R	EA095R	EA096R	EA097R	EA099R
155 mm	200 mm	220 mm	255 mm	300 mm
6"	8"	8 3/4"	10"	12"

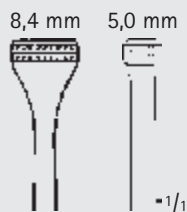

EA101R	EA100R
350 mm	295 mm
14"	11 3/4"

ALLIS

EA092R-EA101R



ALLIS

EA095R

besonders fein  
very delicate  
200 mm, 8"





DE BAKEY Zahnung



Toothing DE BAKEY

**ARAUMATA®**

# Herz- und Gefäß-Chirurgie – Cardiovascular Surgery

Gewebe- und Organfasszangen

Tissue- and Organ Grasping Forceps

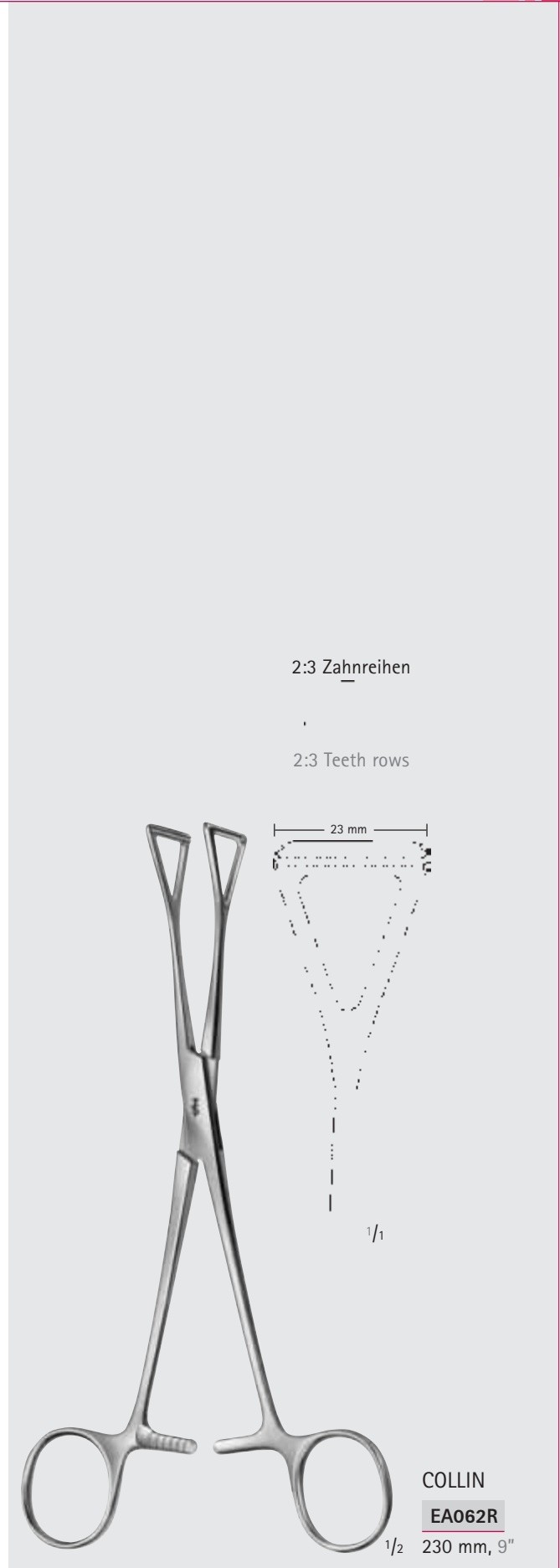
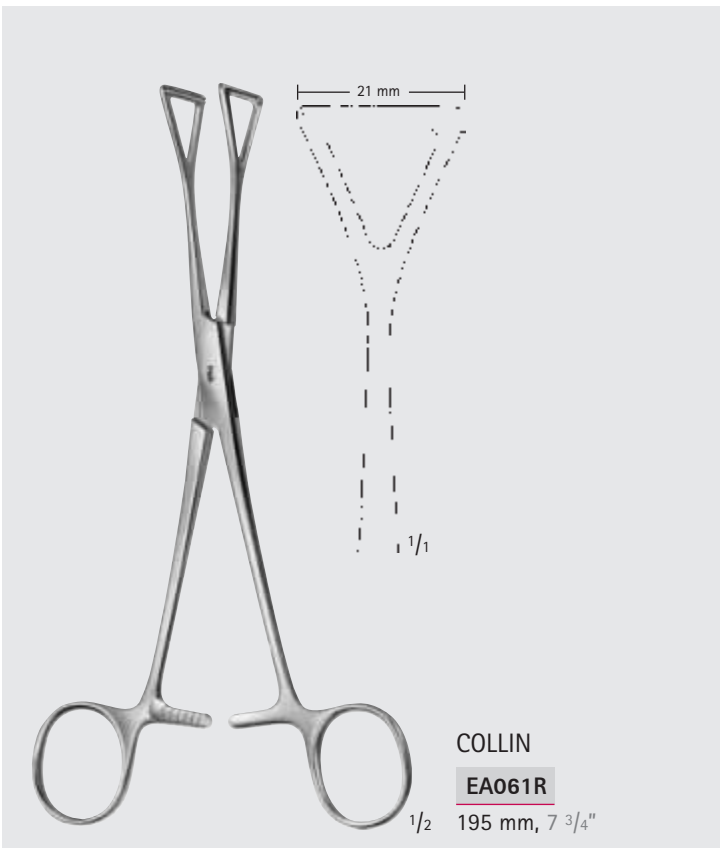
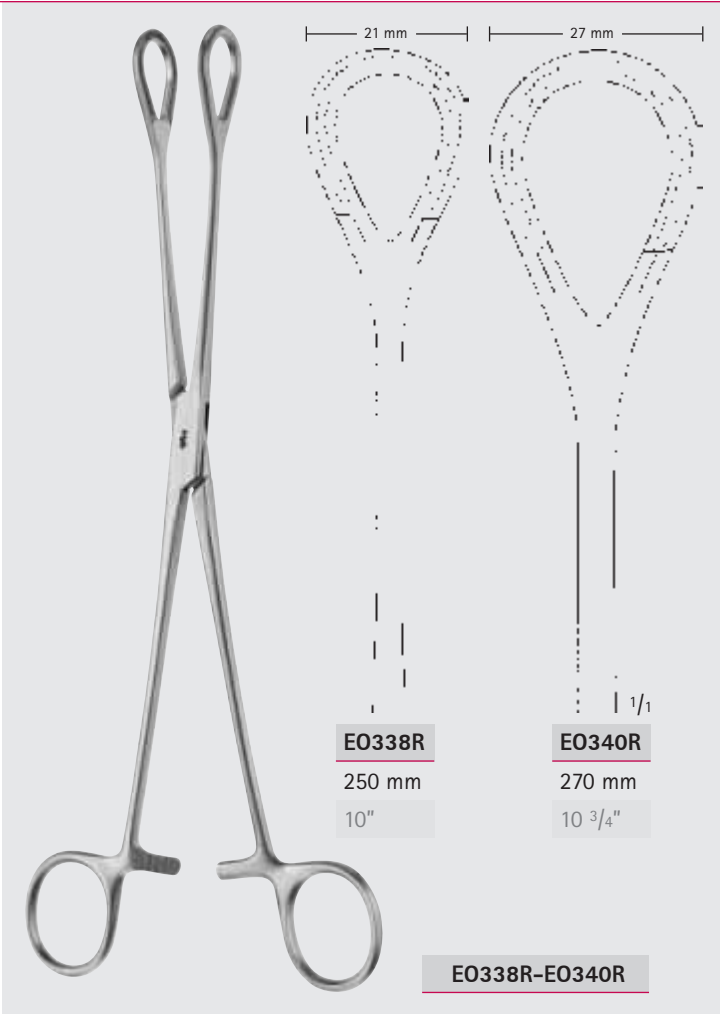

**FB**

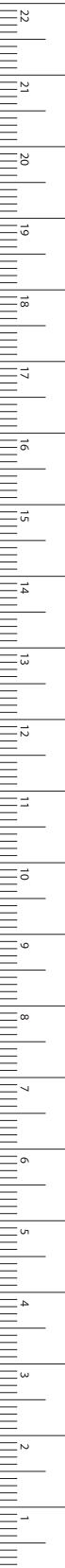

## Herz- und Gefäß-Chirurgie – Cardiovascular Surgery

Lungenfazzangen, -pinzetten

Lung Grasping Forceps

Weitere Gewebefazzangen siehe Rubrik EA

Weitere Ligaturklemmen siehe Rubrik BJ

Further tissue grasping forceps see section EA

Further ligature forceps see section BJ



WILLIAMS

EA028R

160 mm, 6 1/4"

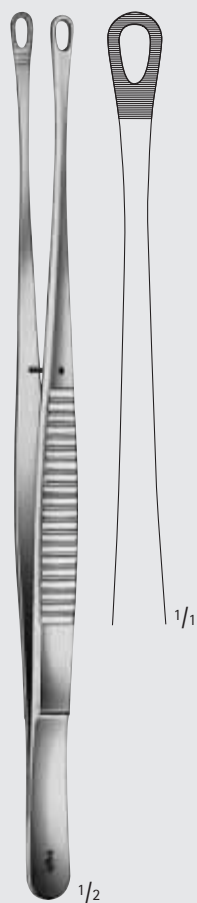

TUTTLE

BD801R

230 mm, 9"

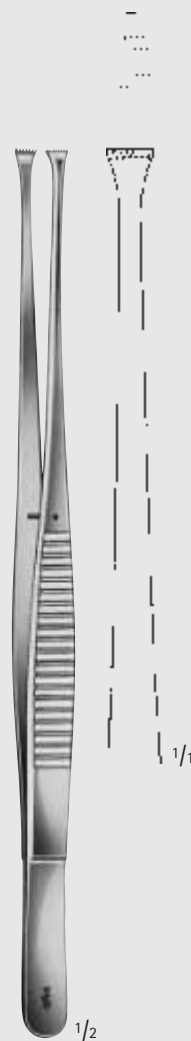

NELSON

BD802R

230 mm, 9"

FB





# Herz- und Gefäß-Chirurgie – Cardiovascular Surgery

Lungenfazzangen  
Lung Grasping Forceps

FB

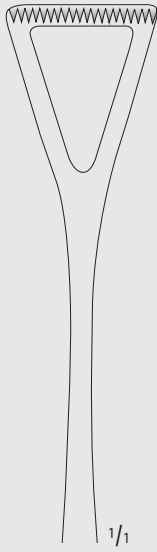
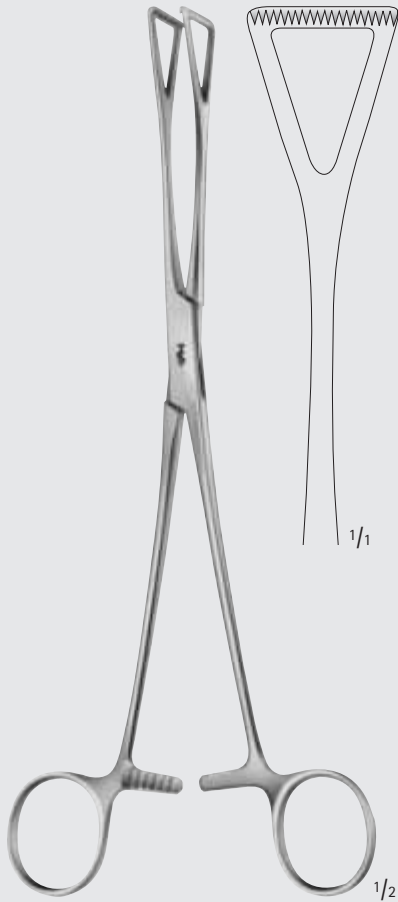

DUVAL

**FB930R**

$1/2$  230 mm, 9"

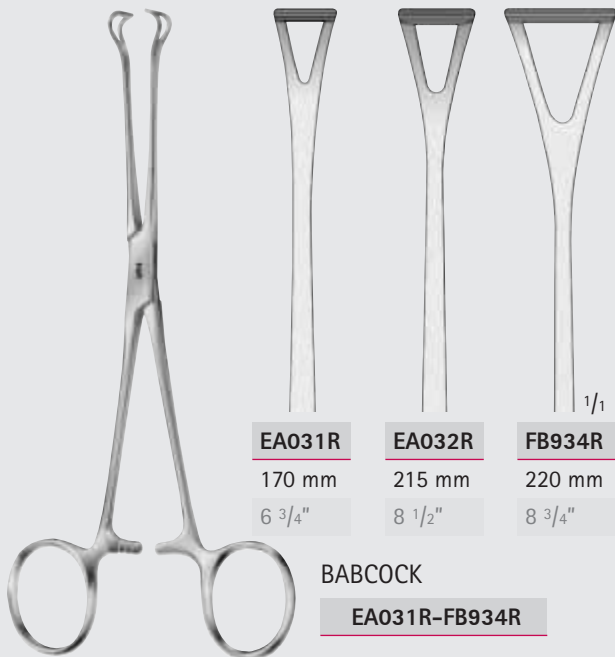

**EA031R**

170 mm

$6 \frac{3}{4}$ "

**EA032R**

215 mm

$8 \frac{1}{2}$ "

**FB934R**

220 mm

$8 \frac{3}{4}$ "

BABCOCK

**EA031R-FB934R**

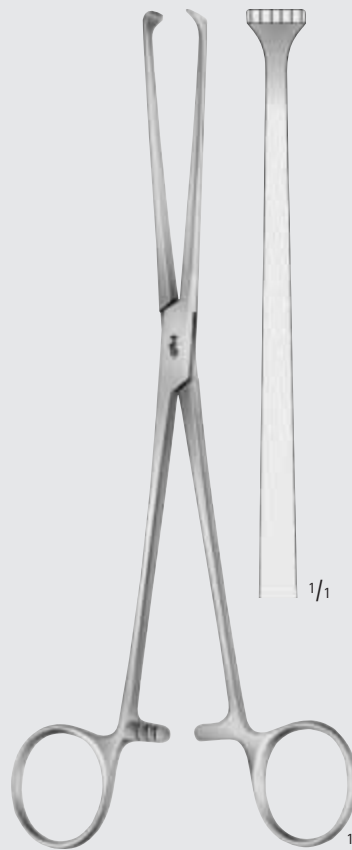

ALLIS

**FB938R**

$1/2$  220 mm,  $8 \frac{3}{4}$ "

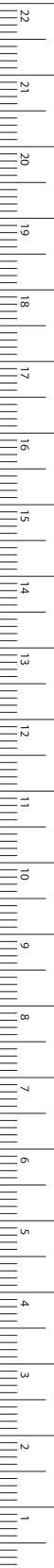

MILLIMETERS

# Herz- und Gefäß-Chirurgie – Cardiovascular Surgery

Präparier- und Ligaturklemmen

Dissecting- and Ligature Forceps

FB

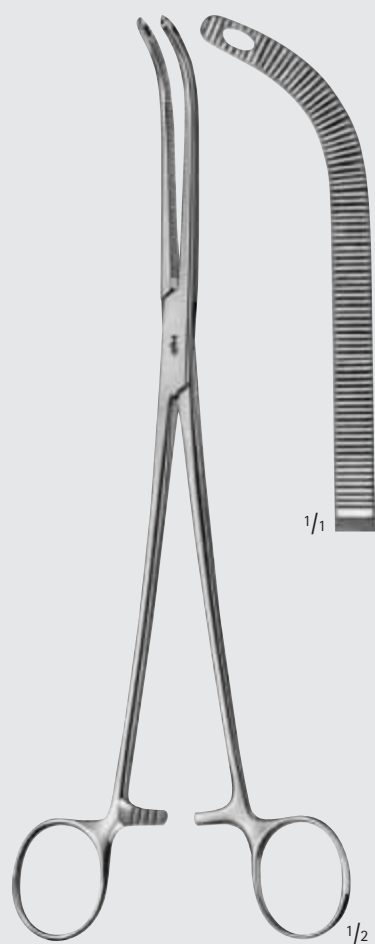

FINOCHIETTO

**BJ052R**

245 mm, 9 3/4"

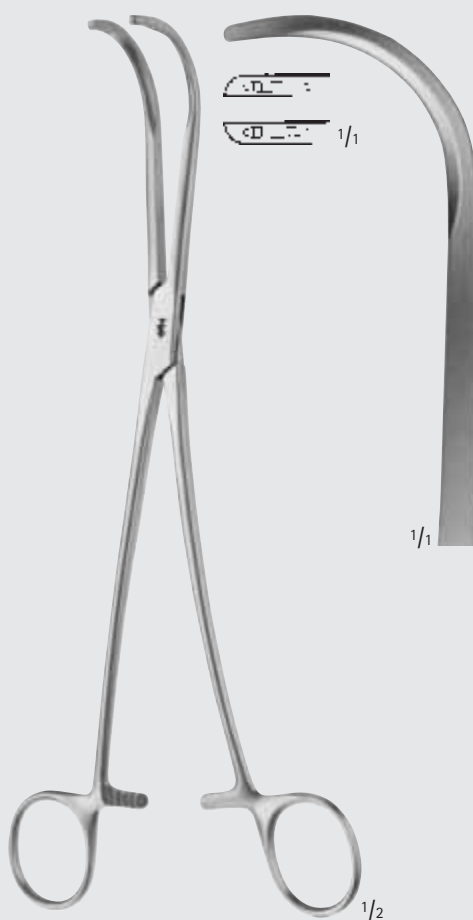

SEMB

**FB961R**

240 mm, 9 1/2"



WIKSTROEM

**BJ051R**

205 mm, 8"



# Herz- und Gefäß-Chirurgie – Cardiovascular Surgery

## Präparier- und Ligaturklemmen

### Dissecting- and Ligature Forceps

FB



MIXTER

**BJ055R**

230 mm, 9"



MIXTER

**BJ061R-BJ062R**

**BJ061R**

220 mm

8 3/4"

**BJ062R**

250 mm

10"



MIXTER

**BJ073R**

290 mm, 11 1/2"



MILLIMETERS

## Herz- und Gefäß-Chirurgie – Cardiovascular Surgery

Fixierklemme, Carotis Shunt Klemmen

Fixation Clamp, Carotid Shunt Clamps

FB



BORST

**FB940R**

Klemme für eine effiziente Verklebung von Gewebeschichten bei der Aortendisektion  
Forceps for efficient tissue gluing in aortic dissection

215 mm, 8 1/2"



**MB238R**

168 mm

6 5/8"

**MB239R**

180 mm

7"

JAVID

**MB238R-MB239R**

Carotis Shunt Klemmen

Carotid shunt clamps



# Herz- und Gefäß-Chirurgie – Cardiovascular Surgery

## Gefäßklemmen Vascular Clamps

FB



BABY-SATINSKY

**FB600R**

Anastomosen-Klemme

Anastomosis clamp

$1/2$  150 mm, 6"



SATINSKY

**FB602R**

Anastomosen-Klemme

Anastomosis clamp

265 mm, 10  $1/2$ "

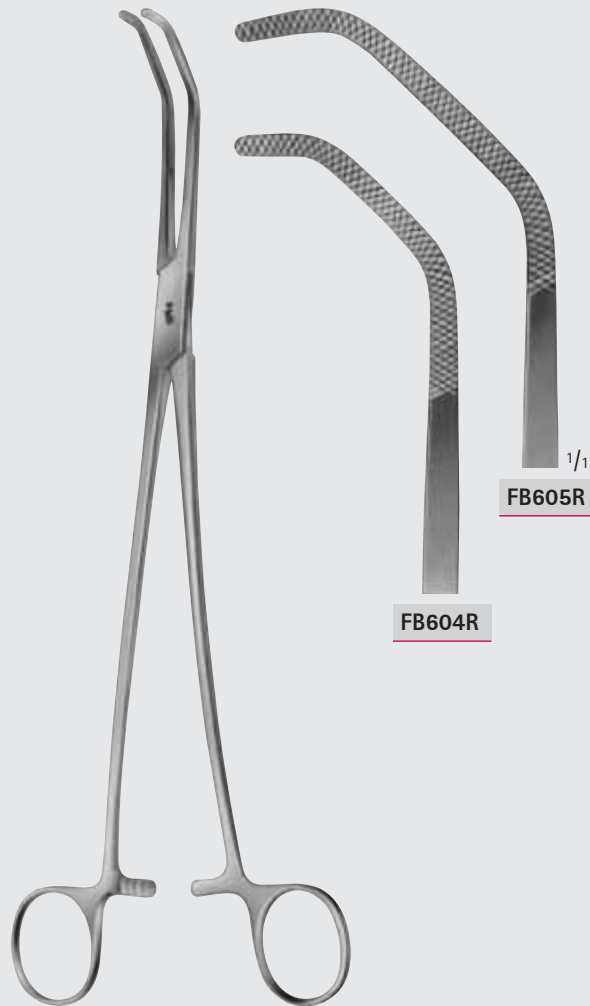

SATINSKY

**FB604R-FB605R**

Anastomosen-Klemmen

Anastomosis clamps

265 mm, 10  $1/2$ "

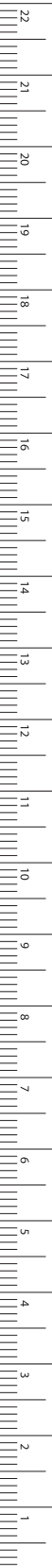

MILLIMETERS

# Herz- und Gefäß-Chirurgie – Cardiovascular Surgery

Gefäßklemmen

Vascular Clamps

FB



**FB633R**  
federnd  
elastic

CRAFOORD-SELLORS

**FB633R**

240 mm, 9 1/2"



**FB634R**  
federnd  
elastic

**FB635R**

CRAFOORD

**FB634R-FB635R**

240 mm, 9 1/2"





## Herz- und Gefäß-Chirurgie – Cardiovascular Surgery

Bronchusklemmen

Bronchus Forceps

FB



PRICE-THOMAS

**FB950R**

225 mm, 9"



**FB955R**

80 mm

**FB954R**

60 mm

**FB954R-FB955R**

230 mm, 9"

MILLIMETERS

## Herz- und Gefäß-Chirurgie – Cardiovascular Surgery

Spülkanülen, Embolusfasszangen

Irrigating Cannulae, Embolus Grasping Forceps

FB



Ø 3 mm diam. 3 mm    Ø 4 mm diam. 4 mm    Ø 5 mm diam. 5 mm    Ø 6 mm diam. 6 mm

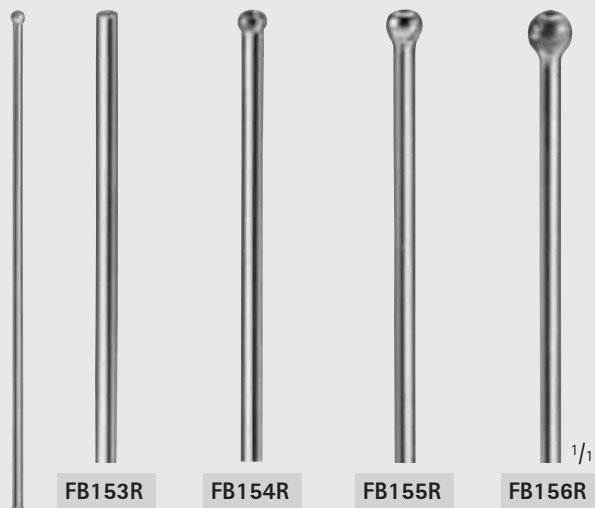

**FB153R**

**FB154R**

**FB155R**

**FB156R**

LUER LOCK 1/2

SCHMID

**FB153R-FB156R**

Gefäß-Spülkanülen,  
biegsam, versilbert  
Vessel irrigating cannulae,  
malleable, silver plated  
150 mm, 6"

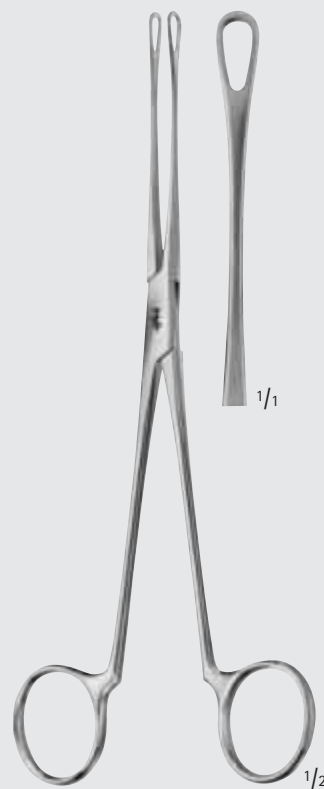

BLAKE

**EB220R**

Embolusfasszange  
Embolus grasping forceps  
205 mm, 8"



**Herz- und Gefäß-Chirurgie – Cardiovascular Surgery**  
 Gefäßdilatoren  
 Vascular dilators

**FB**

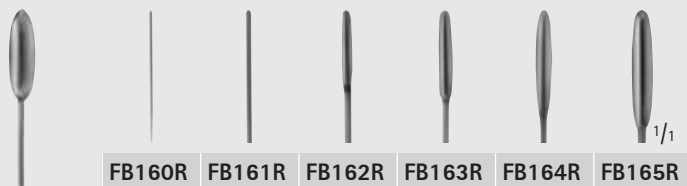

**FB160R** **FB161R** **FB162R** **FB163R** **FB164R** **FB165R**

	Ø Diam.
<b>FB160R</b>	0,5 mm
<b>FB161R</b>	1,0 mm
<b>FB162R</b>	1,5 mm
<b>FB163R</b>	2,0 mm
<b>FB164R</b>	2,5 mm
<b>FB165R</b>	3,0 mm

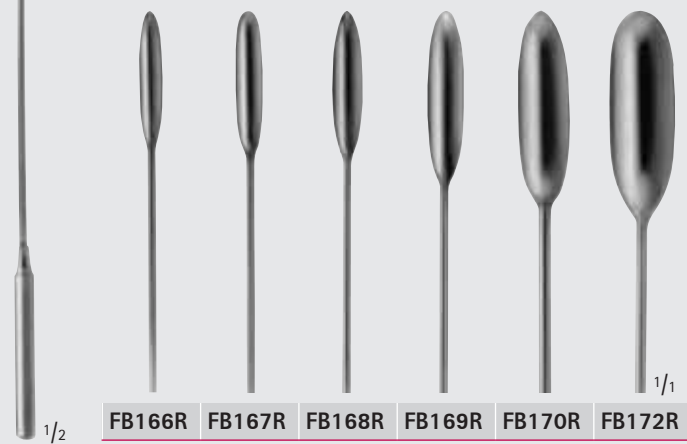

**FB166R** **FB167R** **FB168R** **FB169R** **FB170R** **FB172R**

	Ø Diam.
<b>FB166R</b>	3,5 mm
<b>FB167R</b>	4,0 mm
<b>FB168R</b>	4,5 mm
<b>FB169R</b>	5,0 mm
<b>FB170R</b>	7,0 mm
<b>FB172R</b>	9,0 mm

DE BAKEY

**FB160R-FB172R**

Gefäßdilatoren, biegsam  
 Vascular dilators, malleable  
 190 mm, 7 1/2"

# Herz- und Gefäß-Chirurgie – Cardiovascular Surgery

## Gefäßdilatoren

### Vascular Dilators

FB

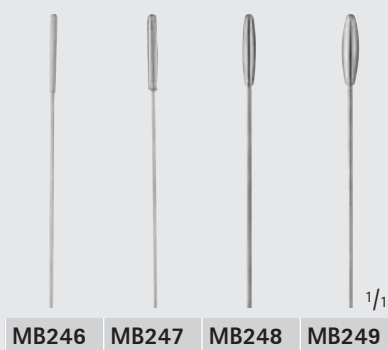

MB246 MB247 MB248 MB249

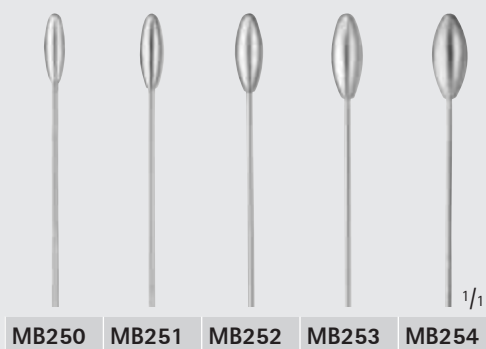

MB250 MB251 MB252 MB253 MB254

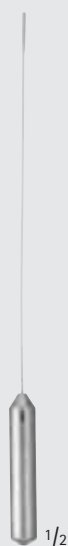

1/2

GARRETT

**MB245**

Set komplett,  
bestehend aus:  
MB246-MB254 jeweils 1 Dilator

Set complete,  
consisting of:  
MB246-MB254 1 dilator of each  
140 mm, 5 1/2"



MB257 MB258 MB259 MB260

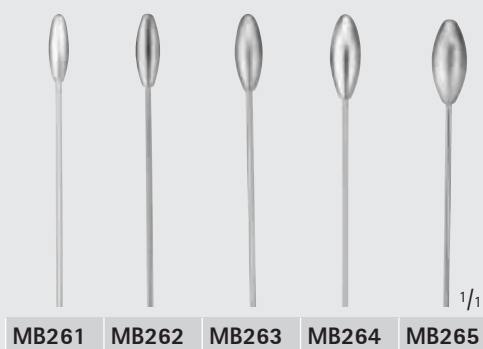

MB261 MB262 MB263 MB264 MB265



1/2

GARRETT

**MB256**

Set komplett,  
bestehend aus:  
MB257-MB265 jeweils 1 Dilator

Set complete,  
consisting of:  
MB257-MB265 1 dilator of each  
215 mm, 8 1/2"



# Herz- und Gefäß-Chirurgie – Cardiovascular Surgery

## Gefäßspatel Vascular Spatulas

FB

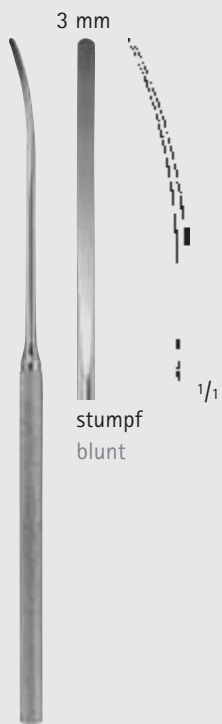

<b>FB150R</b>	185 mm	7 1/4"
<b>FB151R</b>	215 mm	8 1/2"



<b>FD333R</b>
230 mm, 9"



<b>HALLE</b>
<b>OL160R</b>
stumpf blunt
180 mm, 7"



<b>FREER</b>
<b>OL165R</b>
scharf/stumpf sharp/blunt
185 mm, 7 1/4"

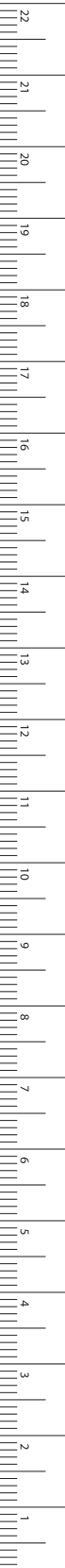

MILLIMETERS

# Herz- und Gefäß-Chirurgie – Cardiovascular Surgery

Gefäßspatel

Vascular Spatulas

FB

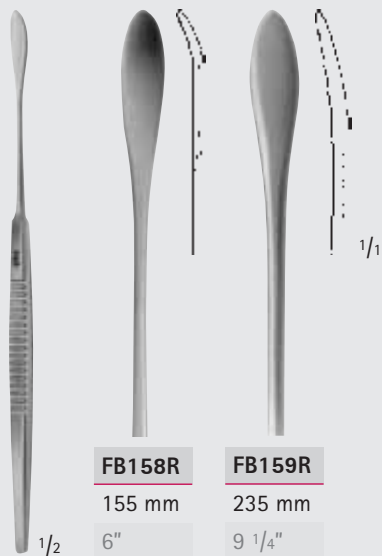

**FB158R**  
155 mm  
6"

**FB159R**  
235 mm  
9 1/4"

SCHMID  
**FB158R-FB159R**

stumpf  
blunt



DAVIS  
**FF300R**  
245 mm, 9 3/4"

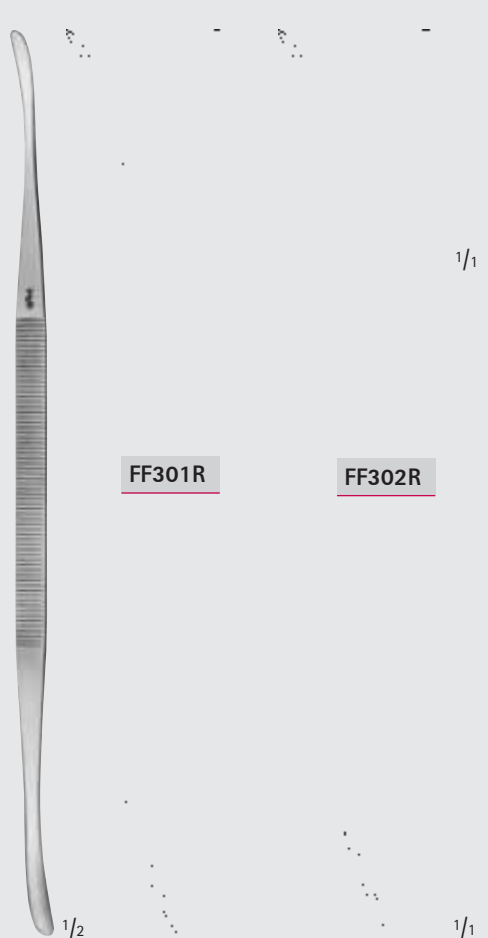

**FF301R**

**FF302R**

TÖNNIS  
**FF301R-FF302R**  
240 mm, 9 1/2"



## Herz- und Gefäß-Chirurgie – Cardiovascular Surgery

### Endarterektomiestripper, Tourniquets

### Endarterectomy Strippers, Tourniquets

**FB**

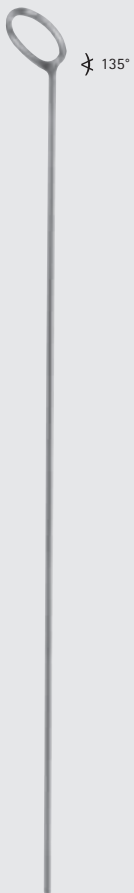
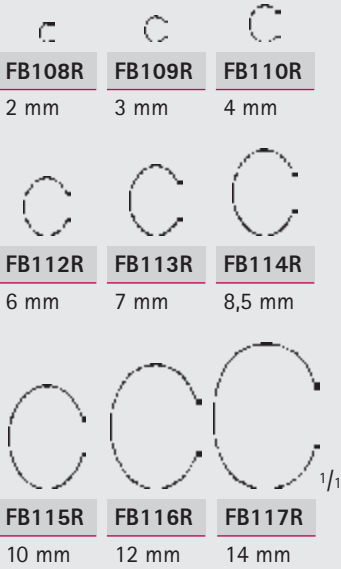

**FB108R-FB117R**  
Endarterektomiestripper  
Endarterectomy strippers  
550 mm, 22"



**FB119R**  
Griff für FB108R-FB117R  
Handle for FB108R-FB117R  
110 mm, 4 3/8"



**RUMEL-BELMONT**  
**FB651R**  
Ø  
diam.  
4 mm  
325 mm, 13"



**FB653R**  
Mandrin allein  
Guide only



**FB654R**  
Mandrin allein  
Guide only

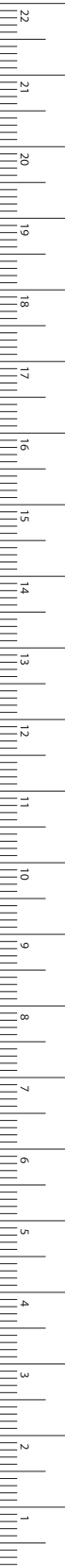

MILLIMETERS

## Herz- und Gefäß-Chirurgie – Cardiovascular Surgery

Bioptom und Aorta-Dilatatoren, Aortenstanzen

Bioptome und Aortic Dilators, Aorta Punches

FB

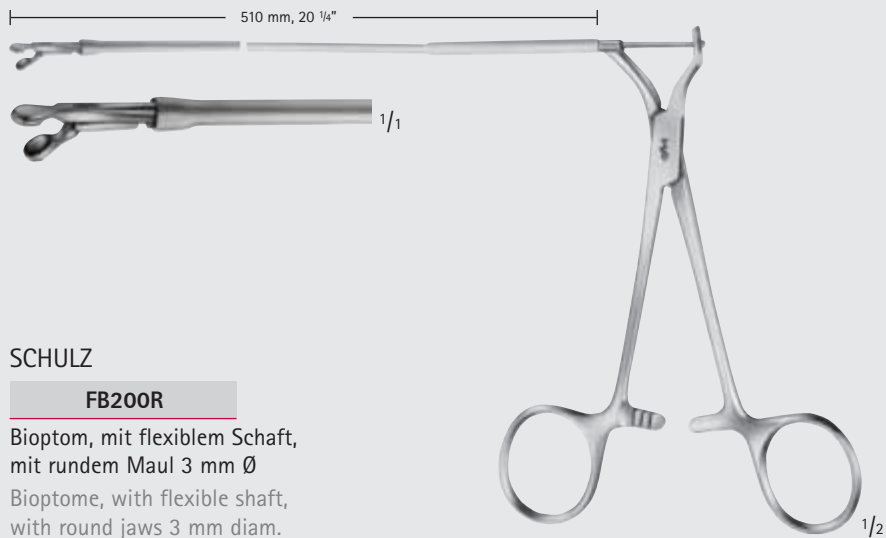

SCHULZ

**FB200R**

Bioptom, mit flexiblem Schaft,  
mit rundem Maul 3 mm Ø

Bioptome, with flexible shaft,  
with round jaws 3 mm diam.

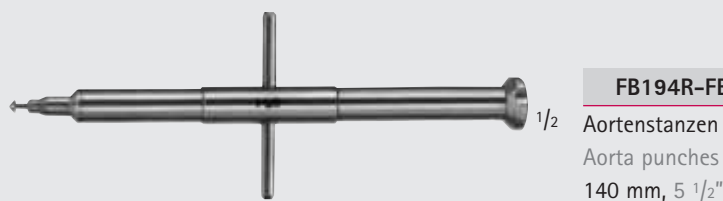

**FB194R-FB196R**

Aortenstanzen  
Aorta punches  
140 mm, 5 1/2"

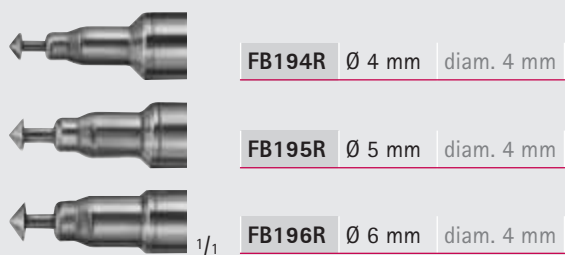

**FB194R** Ø 4 mm diam. 4 mm

**FB195R** Ø 5 mm diam. 4 mm

**FB196R** Ø 6 mm diam. 4 mm

VASCUCUT Stanzenköpfe  
Bestelleinheit:

PAK = Packung à 5 Stück

VASCUCUT Punch heads

Sales unit:

PAK = Package of 5 pieces



**FB184R**

Ø 4 mm  
diam. 4 mm

**FB185R**

Ø 5 mm  
diam. 5 mm

**FB186R**

Ø 6 mm  
diam. 6 mm

**FB180R**

VASCUCUT Handgriff allein  
VASCUCUT Handle only



## Herz- und Gefäß-Chirurgie – Cardiovascular Surgery

### Tunnelierungs- und Durchzugsinstrumentarium für Gefäßprothesen Instrument Set for Tunnelling and Pulling-Through Vascular Grafts

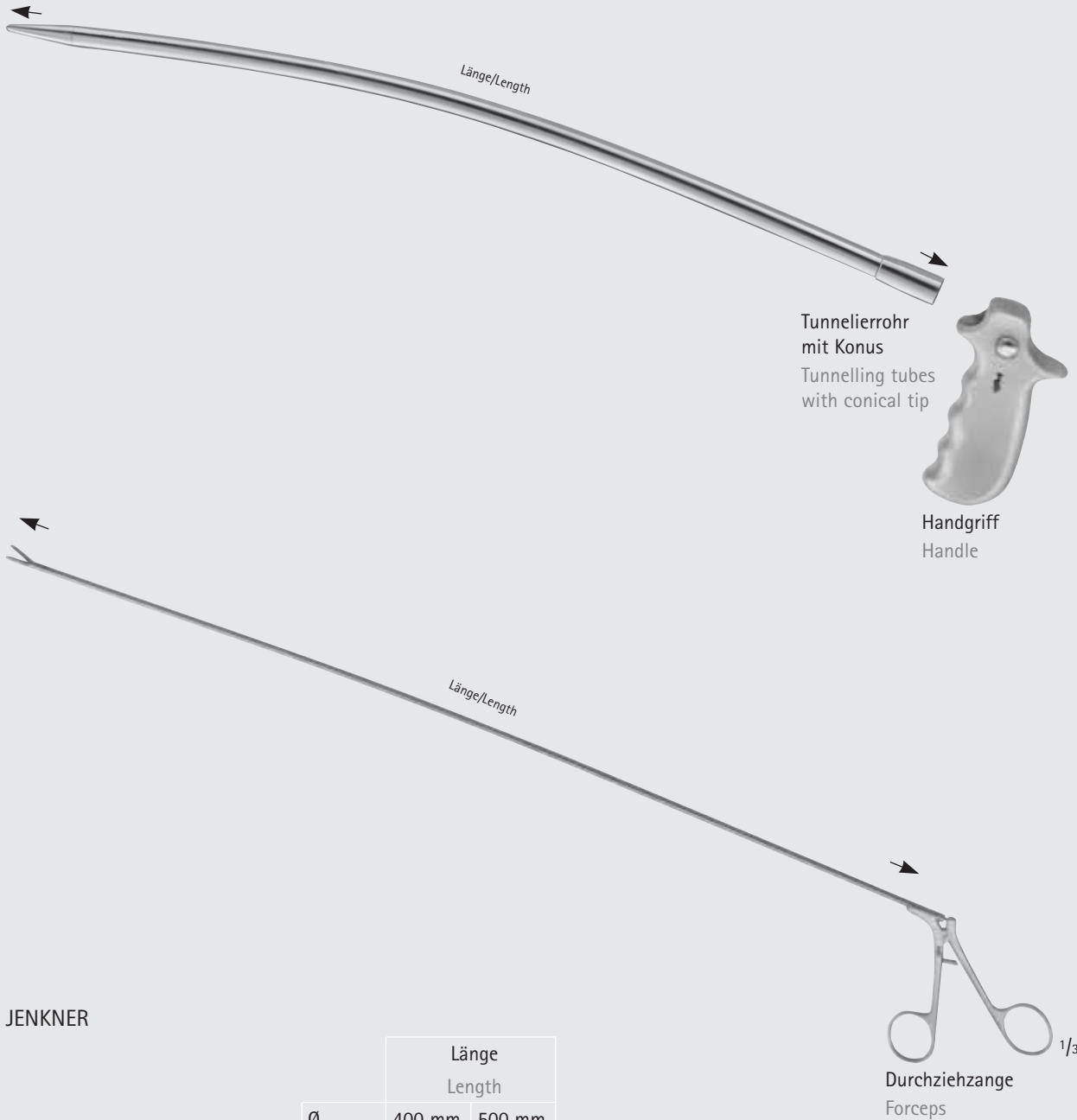
**JENKNER**

	Ø Diam.	Länge Length	
		400 mm 20"	500 mm 20"
<b>Tunnelierrohre mit Konus</b> Tunnelling tubes with conical tip	12 mm	<b>FC004R</b>	<b>FC005R</b>
	14 mm	<b>FC014R</b>	<b>FC015R</b>
	17 mm		<b>FC025R</b>
<b>Handgriff</b> Handle		<b>FC030</b>	
<b>Durchziehzange</b> Forceps		<b>FC034R</b>	<b>FC035R</b>

Informationen über das operative Vorgehen siehe Prospekt C-060.

Information about the operative procedure see leaflet C-060.

## Herz- und Gefäß-Chirurgie – Cardiovascular Surgery

### Gefäßprothesen-Durchziehzange

#### Vascular Prosthesis Draw-In Forceps

Die leichte Krümmung der Zange ermöglicht ein Handling beim Tunnelieren. Zum Durchziehen der Prothese kann die Zange entweder direkt angelegt werden (alloplastische Prothesen) oder mittels der Bulldogklemme (autologe/homologe Prothesen). Die Bulldogklemme sitzt dank Formschluss unverrückbar und sicher im Maul der Einzugszange.

The slight curvature of the introducer forceps permits handling during tunneling. Here the prosthesis can be drawn in by applying the introducer forceps directly to the prosthesis (alloplastic prosthesis) or can be drawn in by means of the bulldog clamp (autologous/homologous prosthesis). Thanks to the interlocking fit, the bulldog clamp rests non-displaceable and securely in the mouth of the introducer forceps.



ALLENBERG

FC048R

gebogen  
curved

540 mm, 21 1/2"



FC049R

Bulldog-Klemme  
Bulldog clamp  
40 mm, 1 1/2"



1/1

WITT

**SR421R** 1,5 x 51 mm

Sternum-Punktionskanüle  
mit Luer-Ansatz  
Sternal puncture needle  
with Luer cone



1/2

SCHUMACHER

**FB911R**

Sternumschere  
Sternal shears  
210 mm, 8 1/4"

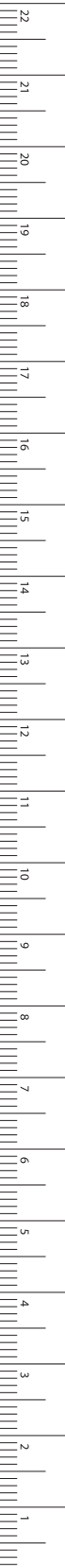

MILLIMETERS

## Herz- und Gefäß-Chirurgie – Cardiovascular Surgery

Sternum-Instrumente

Sternum Instruments

FB



BRAUN-STADLER

**ET141R**

Sternumschere für Kinder  
Sternum shears for children  
200 mm, 8"



LEBSCHE

**FB918R**

Sternummeißel  
Sternum chisel  
200 mm, 8"



# Herz- und Gefäß-Chirurgie – Cardiovascular Surgery

## Rippenscheren Rib Shears

FB



**FB870R**

230 mm, 9"



GLUCK

**FB873**

190 mm, 7 1/2"



BETHUNE

**FB878R**

340 mm, 13 1/2"



SAUERBRUCH

**FB881R**

für Kinder  
for children

240 mm, 9 1/2"

**FB882R**

für Erwachsene  
for adults

270 mm, 10 3/4"

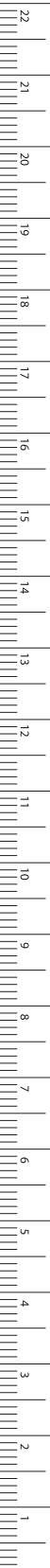

MILLIMETERS

## Herz- und Gefäß-Chirurgie – Cardiovascular Surgery

Rippenscheren

Rib Shears

FB



BRUNNER

**FB892R**

Universalmodell

Universal pattern

340 mm, 13 1/2"



GIERTZ-STILLE

**FB890R**

250 mm, 10"



## Herz- und Gefäß-Chirurgie – Cardiovascular Surgery

Rippenfasszangen, Knochensplitterzangen  
Rib Holding Forceps, Bone Cutting Forceps

FB

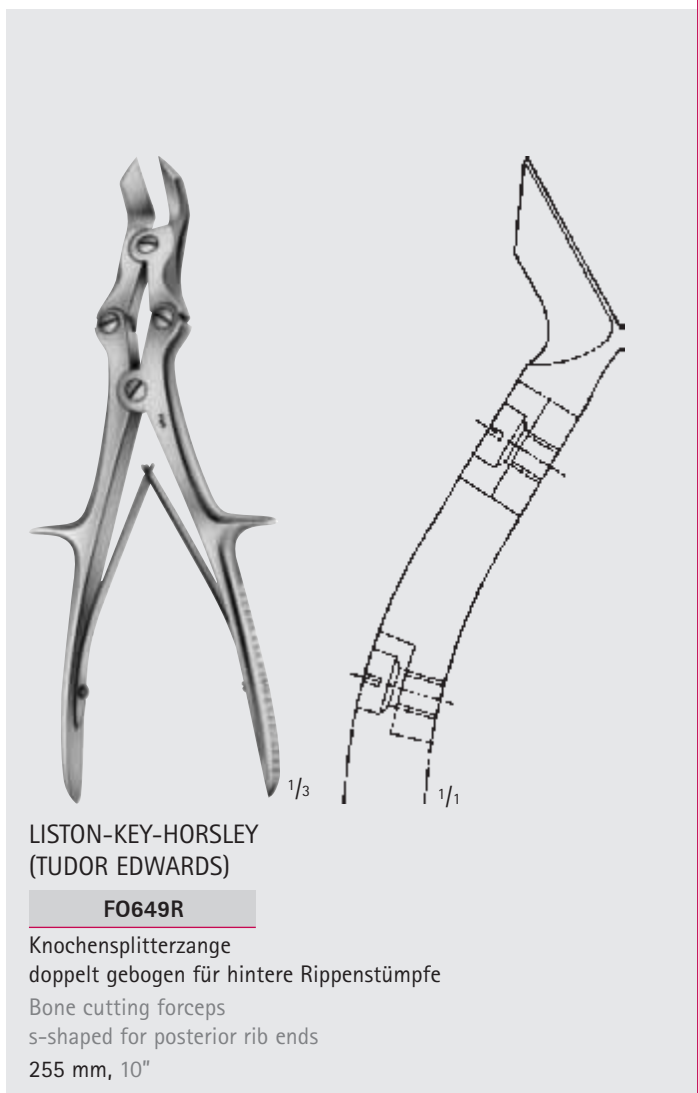
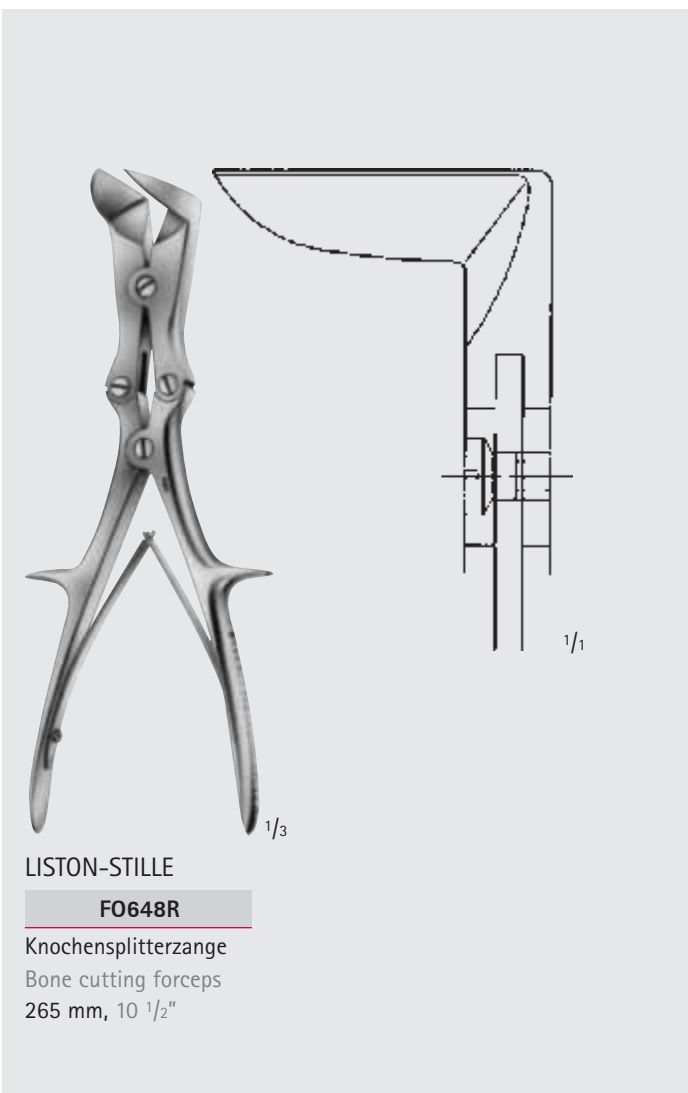
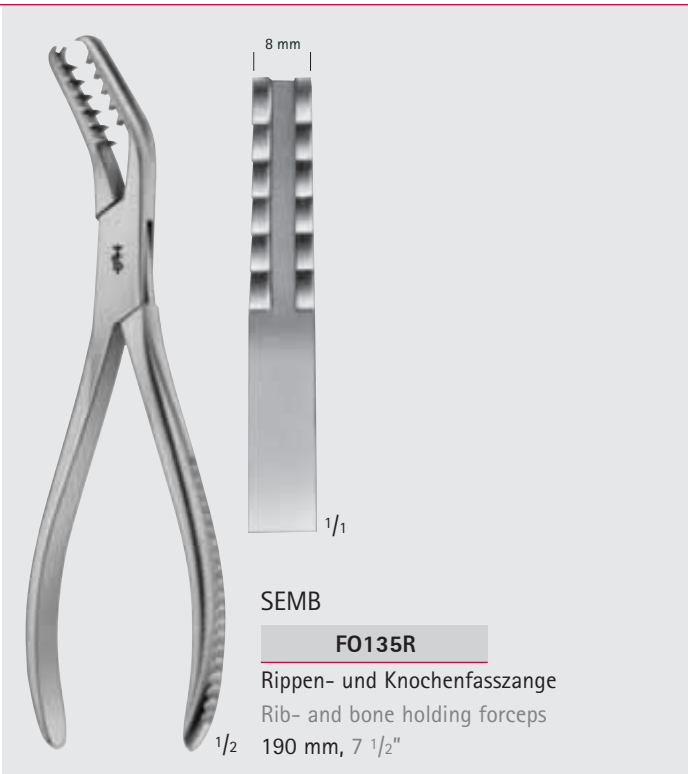

MILLIMETERS

## Herz- und Gefäß-Chirurgie – Cardiovascular Surgery

### Hohlmeißelzangen

### Rib Rongeurs

Weitere Knochenhaltezangen, Knochensplitterzangen und Hohlmeißelzangen siehe Rubrik FO  
Further bone holding forceps, bone cutting forceps and bone rongeurs see section FO

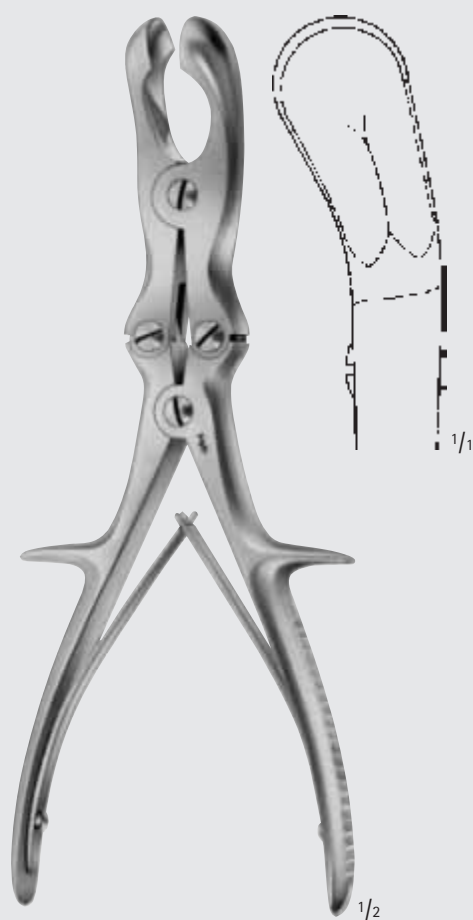

SEMBO

**FO555R**

Hohlmeißelzange zum Kürzen der Rippenstümpfe  
Rib rongeur to shorten the rib stumps

240 mm, 9 1/2"

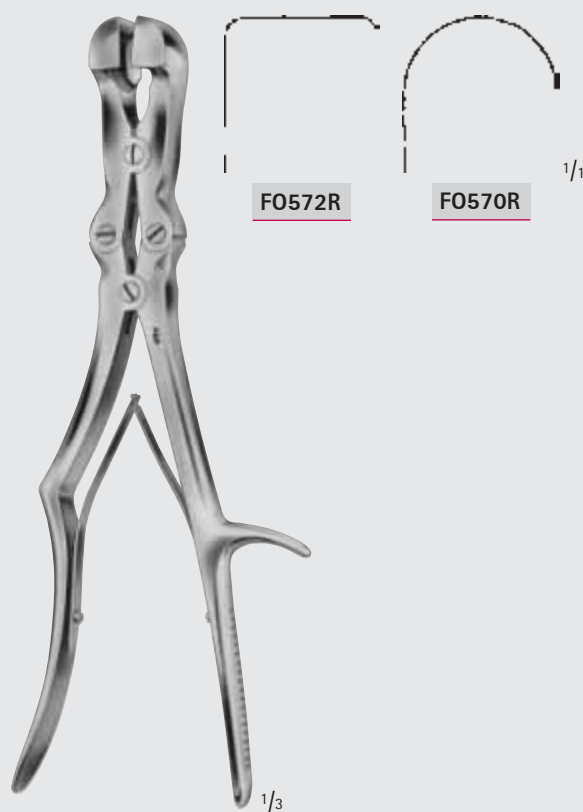

SAUERBRUCH-CORYLLOS

**FO570R-FO572R**

Hohlmeißelzange zum Kürzen der Rippenstümpfe  
Rib rongeur to shorten the rib stumps

310 mm, 12 3/8"







# Herz- und Gefäß-Chirurgie – Cardiovascular Surgery

Rippenraspatorien

Rib Raspatories

FB



FK400R

FK401R

DOYEN

FK400R-FK401R

für Kinder  
for children

175 mm, 7"



FK402R

FK403R

DOYEN

FK402R-FK403R

für Erwachsene  
for adults

175 mm, 7"

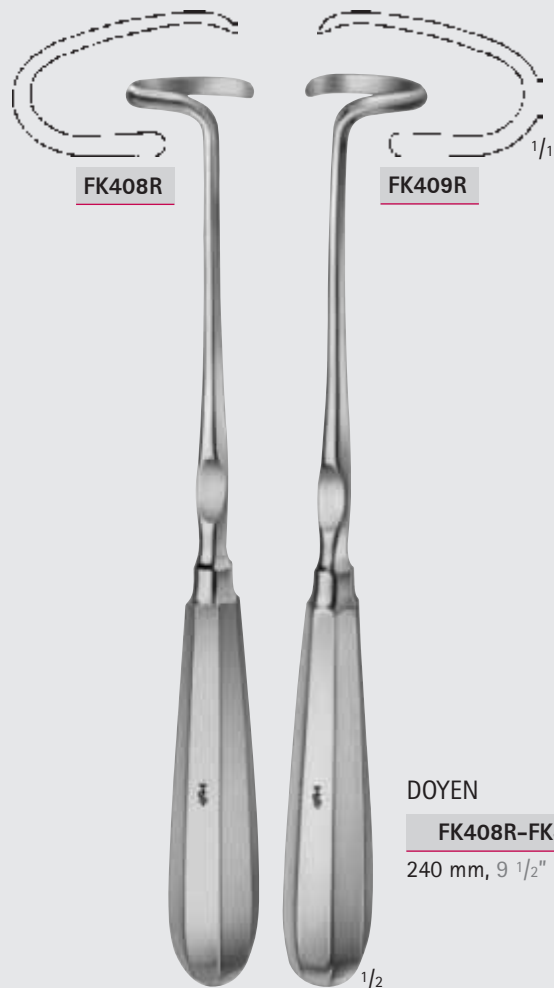

FK408R

FK409R

DOYEN

FK408R-FK409R

240 mm, 9 1/2"



MILLIMETERS

# Herz- und Gefäß-Chirurgie – Cardiovascular Surgery

Rippenraspatorien

Rib Raspatories

FB

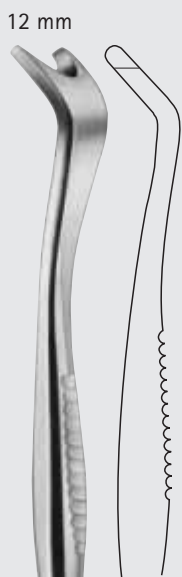

**FK381R**  
190 mm  
7 1/2"

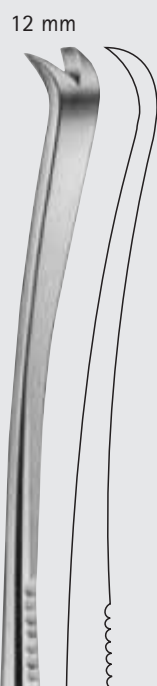

**FK382R**  
230 mm  
9"



**FK383R**  
230 mm  
9"



**FK384R**  
230 mm  
9"



**FK387R**  
230 mm  
9"

SEMB

**FK381R-FK387R**

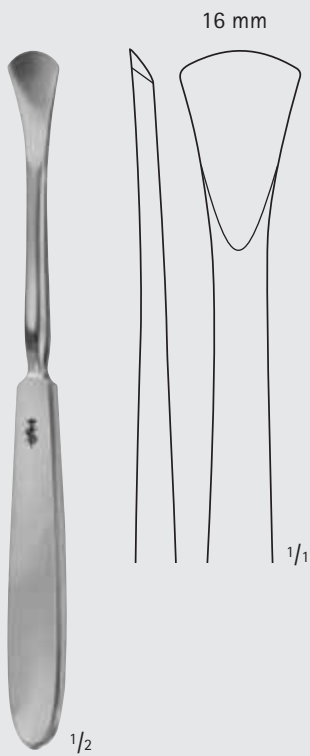
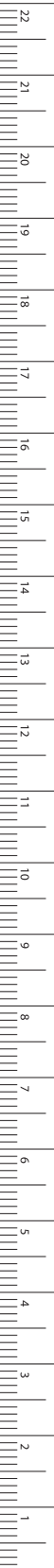

LANGENBECK

**FK360R**

190 mm, 7 1/2"



LAMBOTTE

**FK355R** 5 mm

**FK356R** 10 mm

**FK357R** 15 mm

**FK358R** 20 mm

**FK359R** 25 mm

215 mm, 8 1/2"

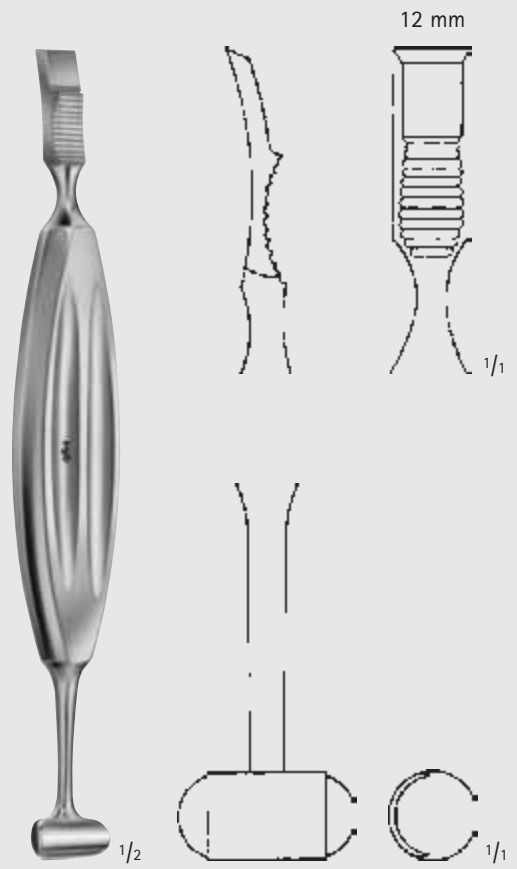

ALEXANDER

**FK420R**

210 mm, 8 1/4"

# Herz- und Gefäß-Chirurgie – Cardiovascular Surgery

## Thoraxsperrer (Aluminium)

### Thoracic Retractors (Aluminium)

FB



Maßangaben für Blattgrößen der Rippensperrer

1. Zahl = Tiefe Beispiel: 38 x 45 mm

2. Zahl = Breite

Dimensions for blade size of rib spreaders:

1st number = depth Example: 38 x 45 mm

2nd number = width

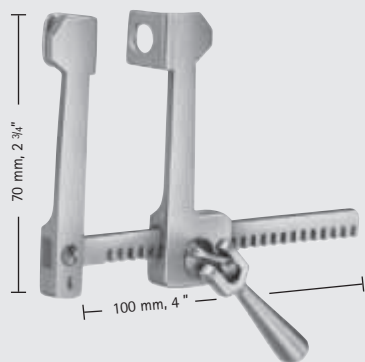

Blätter  
Blades  
**FINOCHIETTO**  
**FC040A** 12 x 15 mm

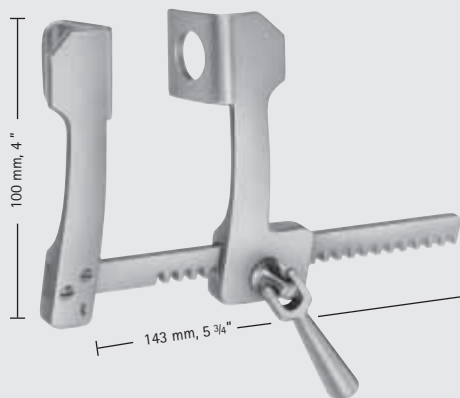

Blätter  
Blades  
**FINOCHIETTO**  
**FC041A** 28 x 30 mm

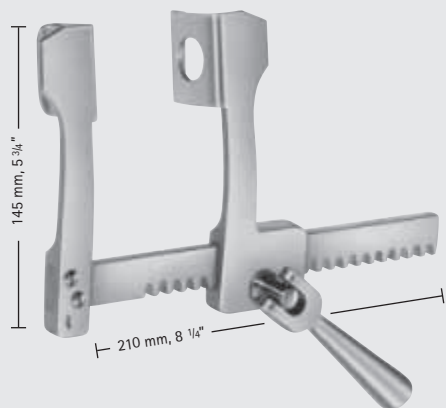

Blätter  
Blades  
**FINOCHIETTO**  
**FC042A** 31 x 45 mm

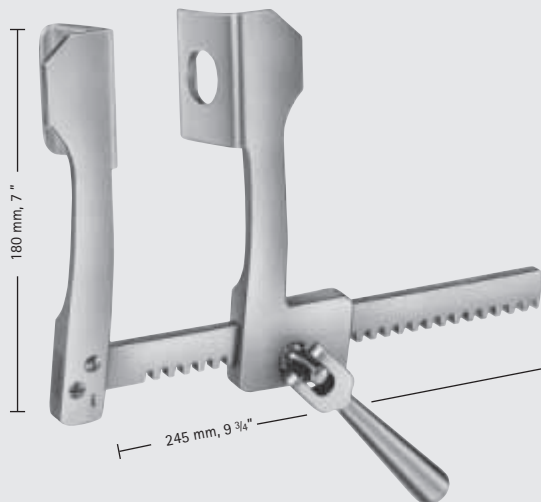

Blätter  
Blades  
**FINOCHIETTO**  
**FC043A** 42 x 61 mm





## Herz- und Gefäß-Chirurgie – Cardiovascular Surgery

Thoraxsperrer (Aluminium), Rippensperrer für Kleinkinder  
Thoracic Retractors (Aluminium), Rib Retractors for Infants

FB

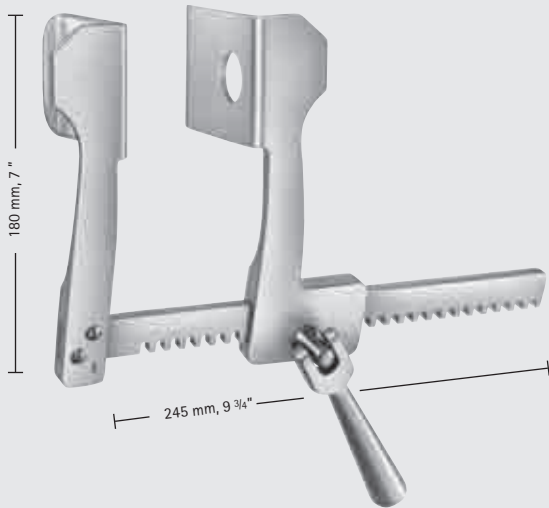

FINOCHIETTO  
Blätter  
Blades  
**FC044A** 74 x 64 mm

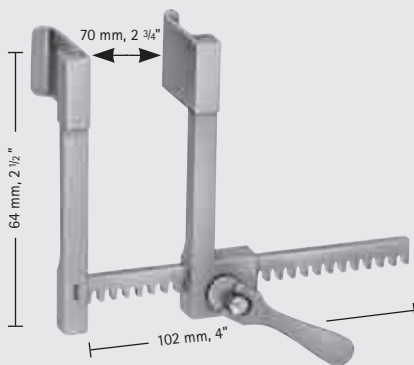

STRUCK  
**FB852R**

Rippensperrer für Kleinkinder  
komplett,  
bestehend aus:

- FB853R Sperrer allein
- FB857R Blätter (Paar)
- FB858R Blätter (Paar)

Rib spreader for infants complete,  
consisting of:

- FB853R Retractor only
- FB857R Blades (pair)
- FB858R Blades (pair)

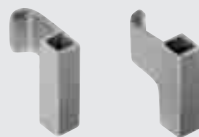

Blätter  
Blades

**FB854R** 10 x 10 mm

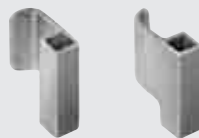

Blätter  
Blades

**FB855R** 10 x 15 mm



Blätter  
Blades

**FB857R** 15 x 20 mm



Blätter  
Blades

**FB856R** 10 x 20 mm



Blätter  
Blades

**FB858R** 20 x 20 mm

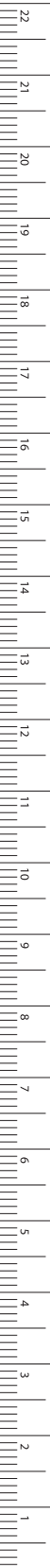

MILLIMETERS

## Herz- und Gefäß-Chirurgie – Cardiovascular Surgery

Rippensperrer für Kinder  
Rib Retractors for Infants

FB

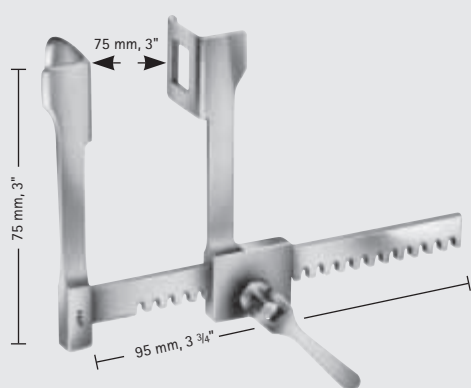

FINOCHIETTO  
Blätter  
Blades  
**FB830R** 18 x 21 mm

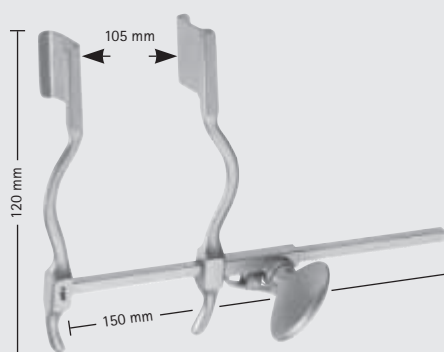

HERTZLER  
Blätter  
Blades  
**BV512R** 20 x 25 mm

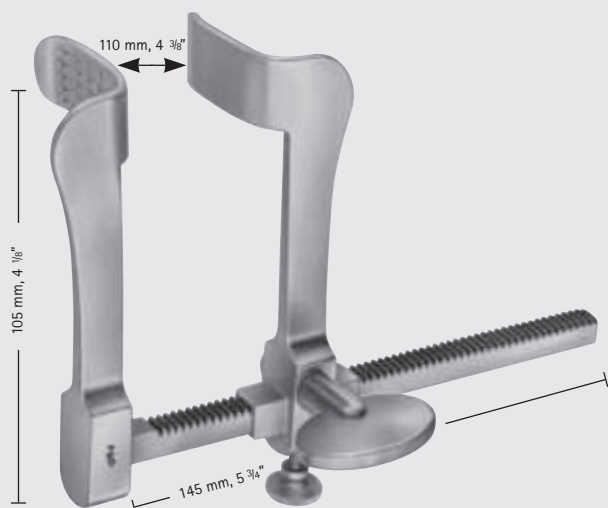

TUFFIER  
Blätter  
Blades  
**FB847R** 32 x 19 mm





# Herz- und Gefäß-Chirurgie – Cardiovascular Surgery

## Rippensperrer Rib Retractors

FB

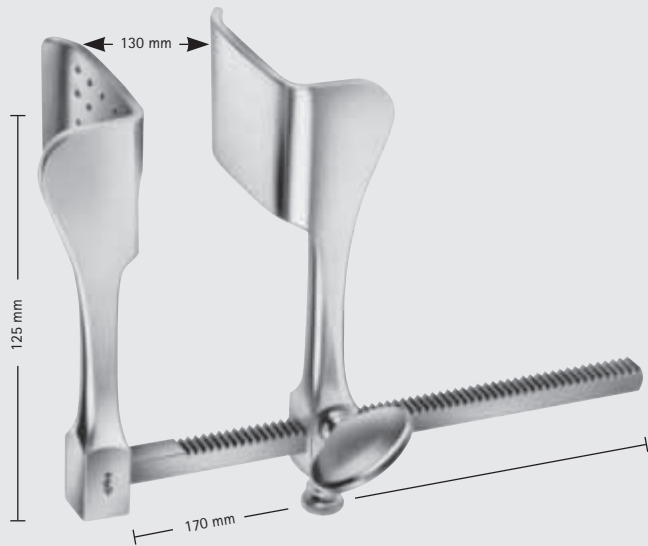

TUFFIER

Blätter  
Blades

**FB800R**

43 x 53 mm

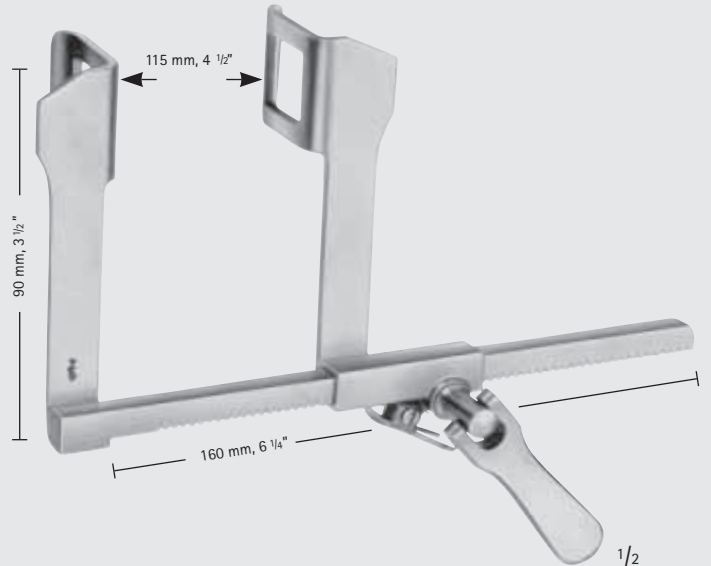

HAIGHT

Blätter  
Blades

**FB835R**

30 x 30 mm

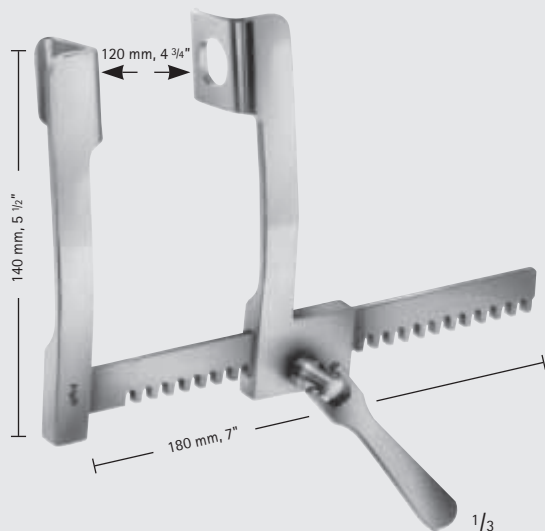

FINOCHIETTO

Blätter  
Blades

**FB836R**

28 x 32 mm

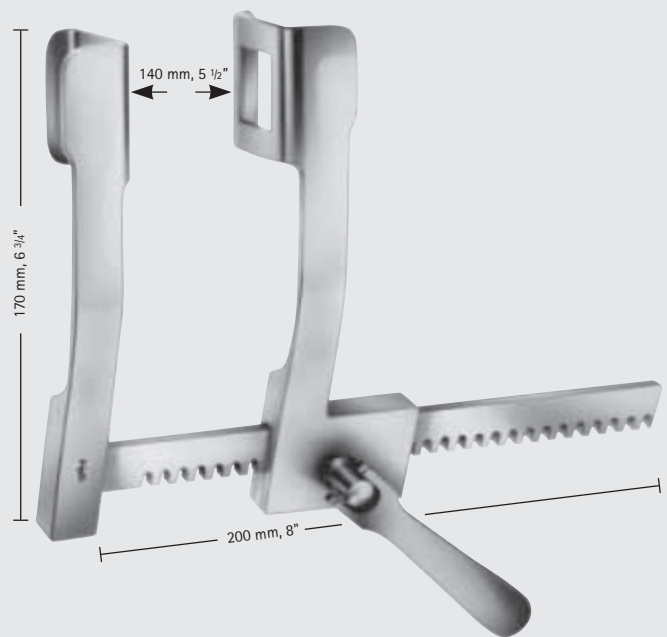

FINOCHIETTO

Blätter  
Blades

**FB802R**

36 x 45 mm



MILLIMETERS

## Herz- und Gefäß-Chirurgie – Cardiovascular Surgery

Rippensperrer

Rib Retractors

FB

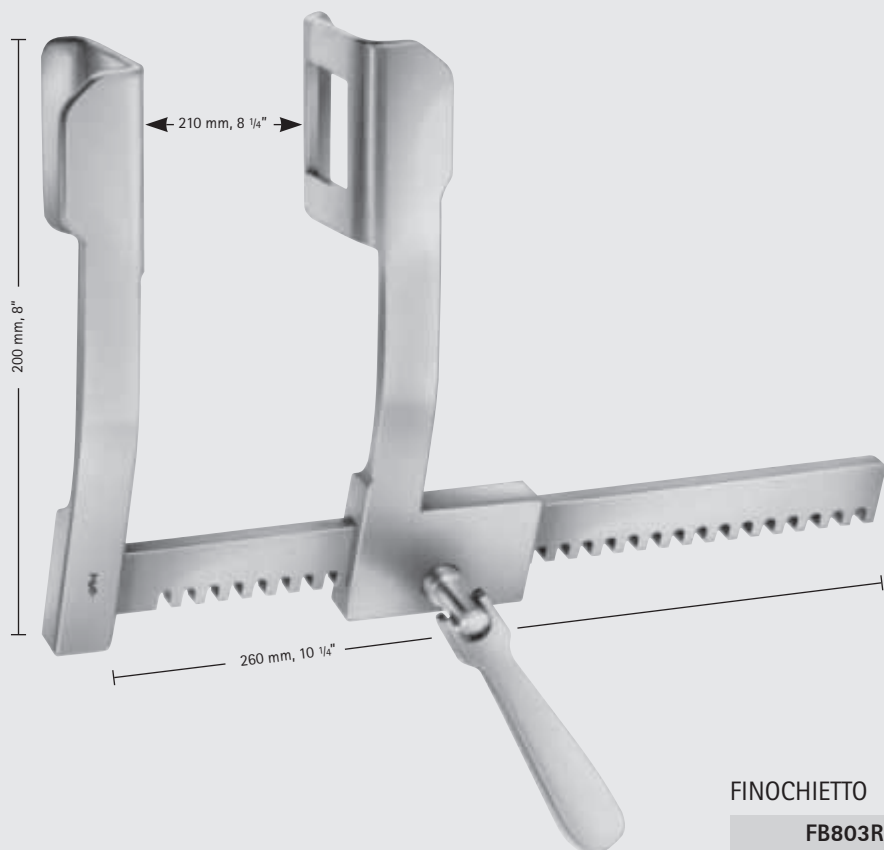

FINOCHIETTO

**FB803R**

Blätter

Blades

44 x 65 mm

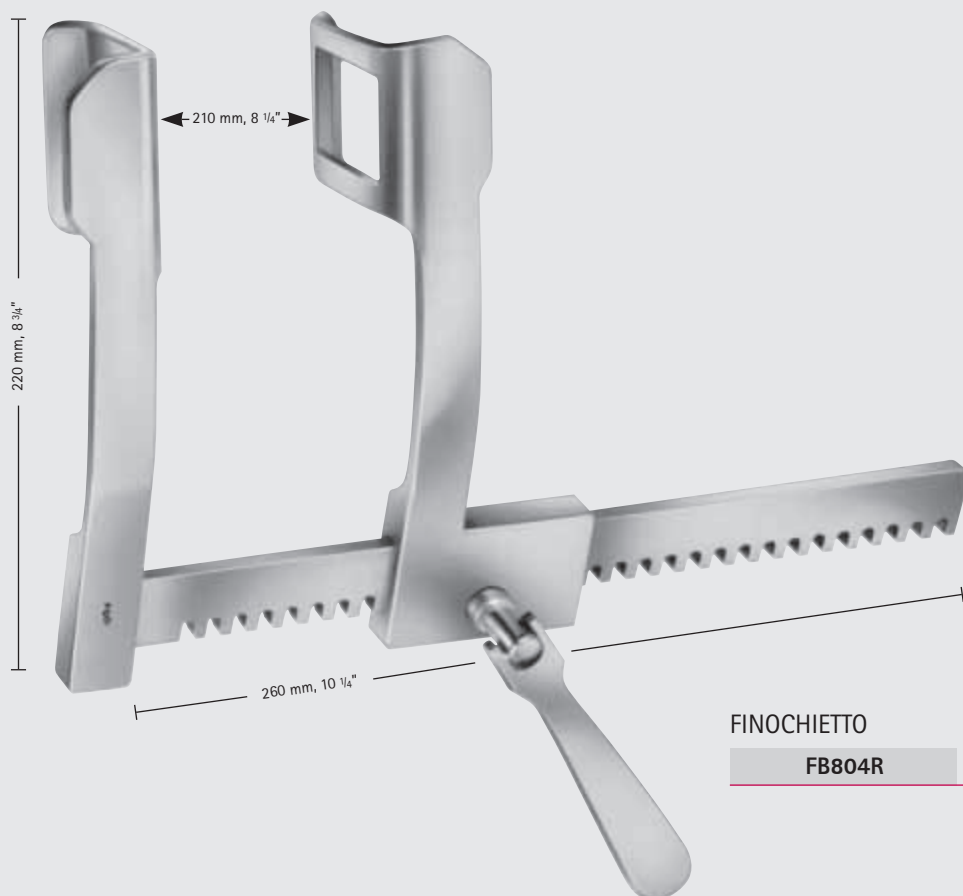

FINOCHIETTO

**FB804R**

Blätter

Blades

65 x 65 mm







## Herz- und Gefäß-Chirurgie – Cardiovascular Surgery

Rippensperrer  
Rib Retractors

FB

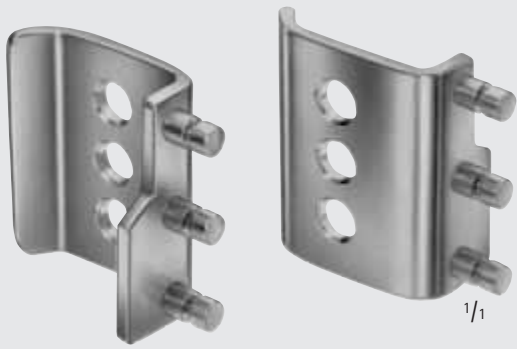

Blätter  
Blades

**FB806R** 45 x 64 mm

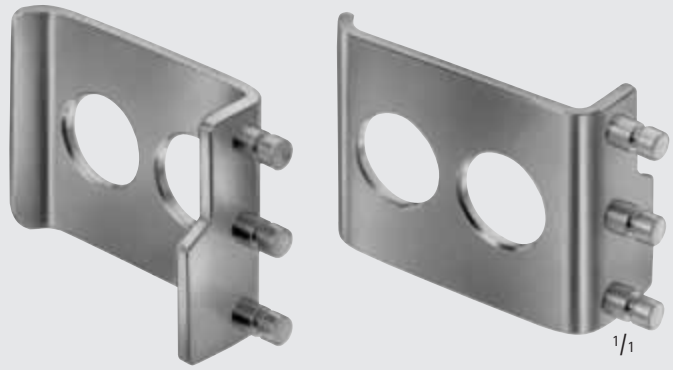

Blätter  
Blades

**FB807R** 75 x 64 mm

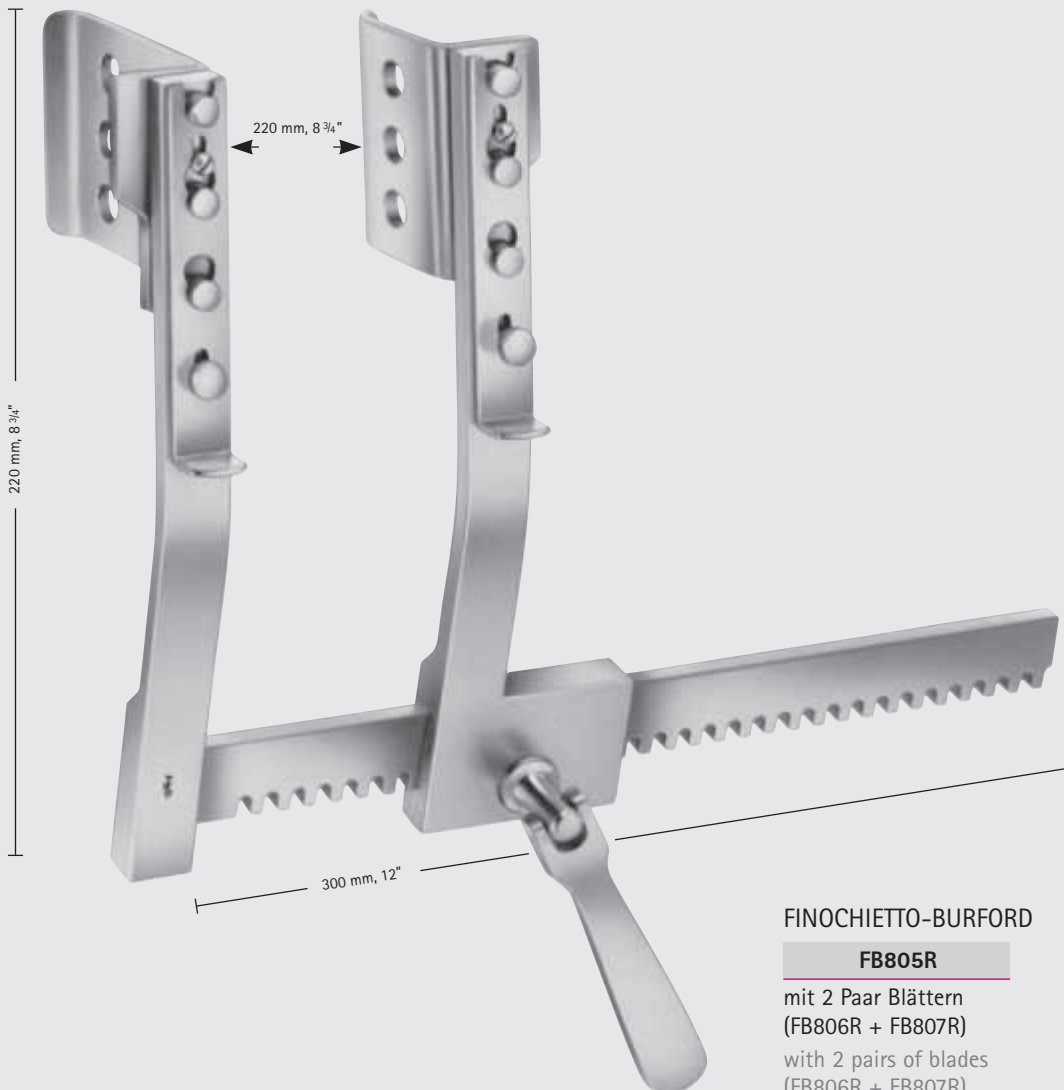

**FINOCHIETTO-BURFORD**

**FB805R**

mit 2 Paar Blättern  
(FB806R + FB807R)  
with 2 pairs of blades  
(FB806R + FB807R)



MILLIMETERS

## Herz- und Gefäß-Chirurgie – Cardiovascular Surgery

### Rippensperr器

### Rib Retractors

Besondere Vorteile:

- Blätter ohne Schrauben und Hebel austauschbar.
- Keine überstehenden Teile, glatte Flächen, daher kein Hängenbleiben von Ligaturfäden usw.

Special advantages:

- Improved fixing system for interchangeable blades.
- No protruding parts, therefore no risk of catching sutures.

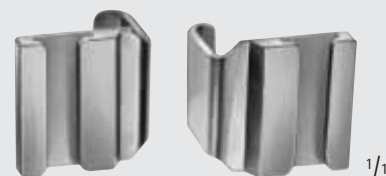

**FB810R** 30 x 30 mm

Blätter

Blades



**FB811R** 40 x 40 mm

Blätter

Blades



**FB812R** 50 x 50 mm

Blätter

Blades

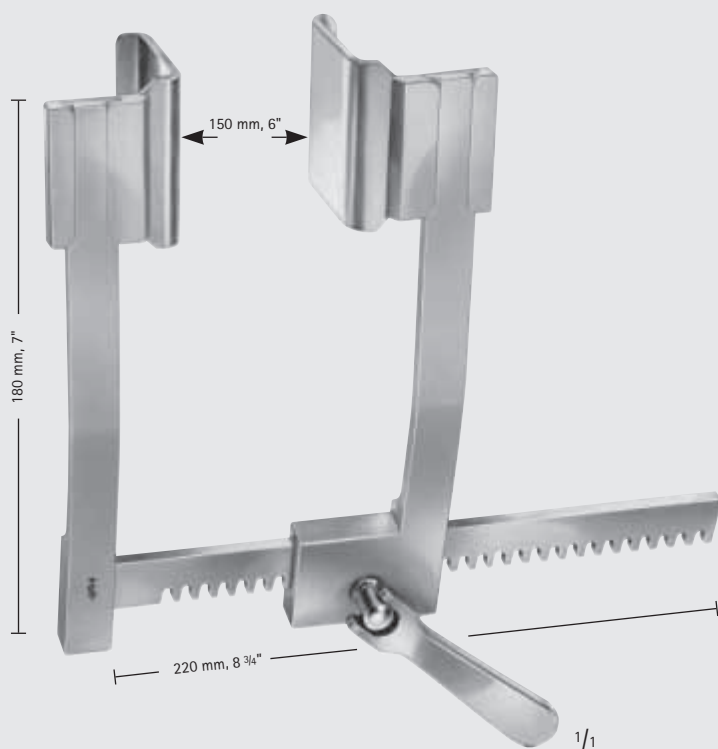

DE BAKEY

#### **FB808R**

Rippensperr器 komplett,  
bestehend aus:

- FB809R Sperr器 allein
- FB810R Blätter (Paar)
- FB811R Blätter (Paar)
- FB812R Blätter (Paar)

Rib spreader complete,  
consisting of:

- FB809R Spreader only
- FB810R Blades (pair)
- FB811R Blades (pair)
- FB812R Blades (pair)

## Herz- und Gefäß-Chirurgie – Cardiovascular Surgery

### Rippensperrer Rib Retractors

Besondere Vorteile:

- Blätter ohne Schrauben und Hebel austauschbar.
- Keine überstehenden Teile, glatte Flächen, daher kein Hängenbleiben von Ligaturfäden usw.

Special advantages:

- Improved fixing system for interchangeable blades.
- No protruding parts, therefore no risk of catching sutures.



**FB813R** 50 x 66 mm  
Sternotomieblätter  
Sternotomy blades



**FB816R** 60 x 60 mm  
Blätter  
Blades



**FB817R** 50 x 80 mm  
Blätter  
Blades



**FB818R** 40 x 100 mm  
Blätter  
Blades



**FB819R** 80 x 60 mm  
Blätter  
Blades

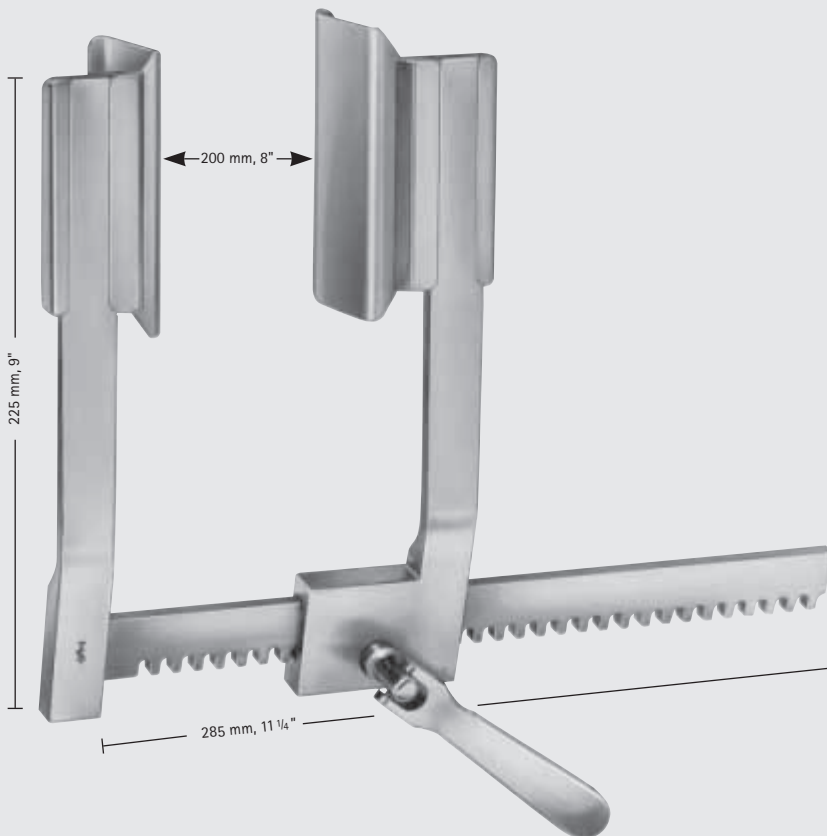

DE BAKEY

**FB814R**

Rippensperrer komplett,  
bestehend aus:

- FB815R Sperrer allein
- FB816R Blätter (Paar)
- FB817R Blätter (Paar)
- FB818R Blätter (Paar)

Spreader complete,  
consisting:

- FB815R Spreader only
- FB816R Blades (pair)
- FB817R Blades (pair)
- FB818R Blades (pair)

## Herz- und Gefäß-Chirurgie – Cardiovascular Surgery

Sternum-Sperrer

Sternum Spreaders

FB

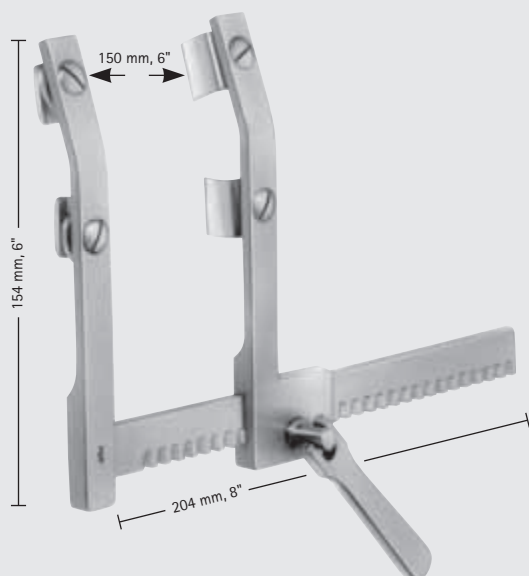

MORSE

**FB845R**

für Kinder  
mit beweglichen Doppelblättern  
Blätter jeweils 12 x 20 mm  
for children  
with movable double blades  
each blade 12 x 20 mm

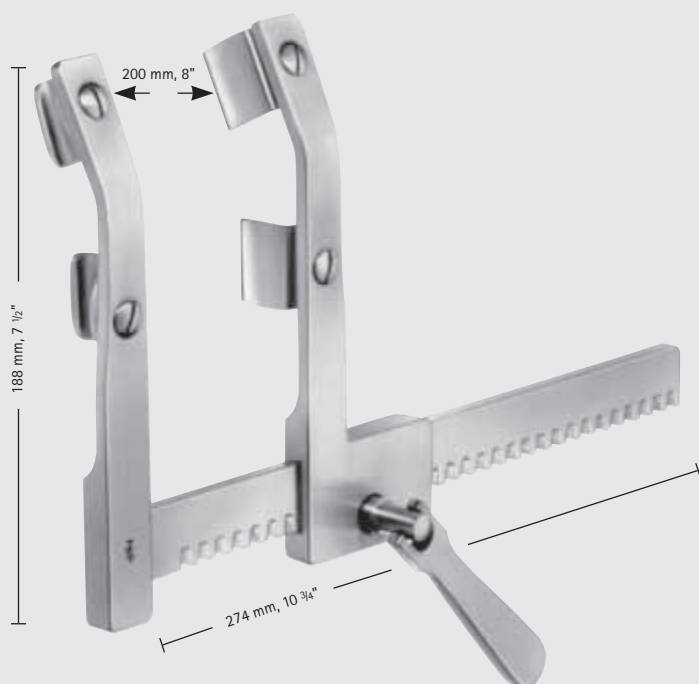

MORSE

**FB846R**

für Erwachsene  
mit beweglichen  
Doppelblättern  
Blätter jeweils 19 x 29 mm  
for adults  
with movable double blades  
each blade 19 x 29 mm

## Herz- und Gefäß-Chirurgie – Cardiovascular Surgery

Sternum-Sperrer  
Sternum Spreaders

FB

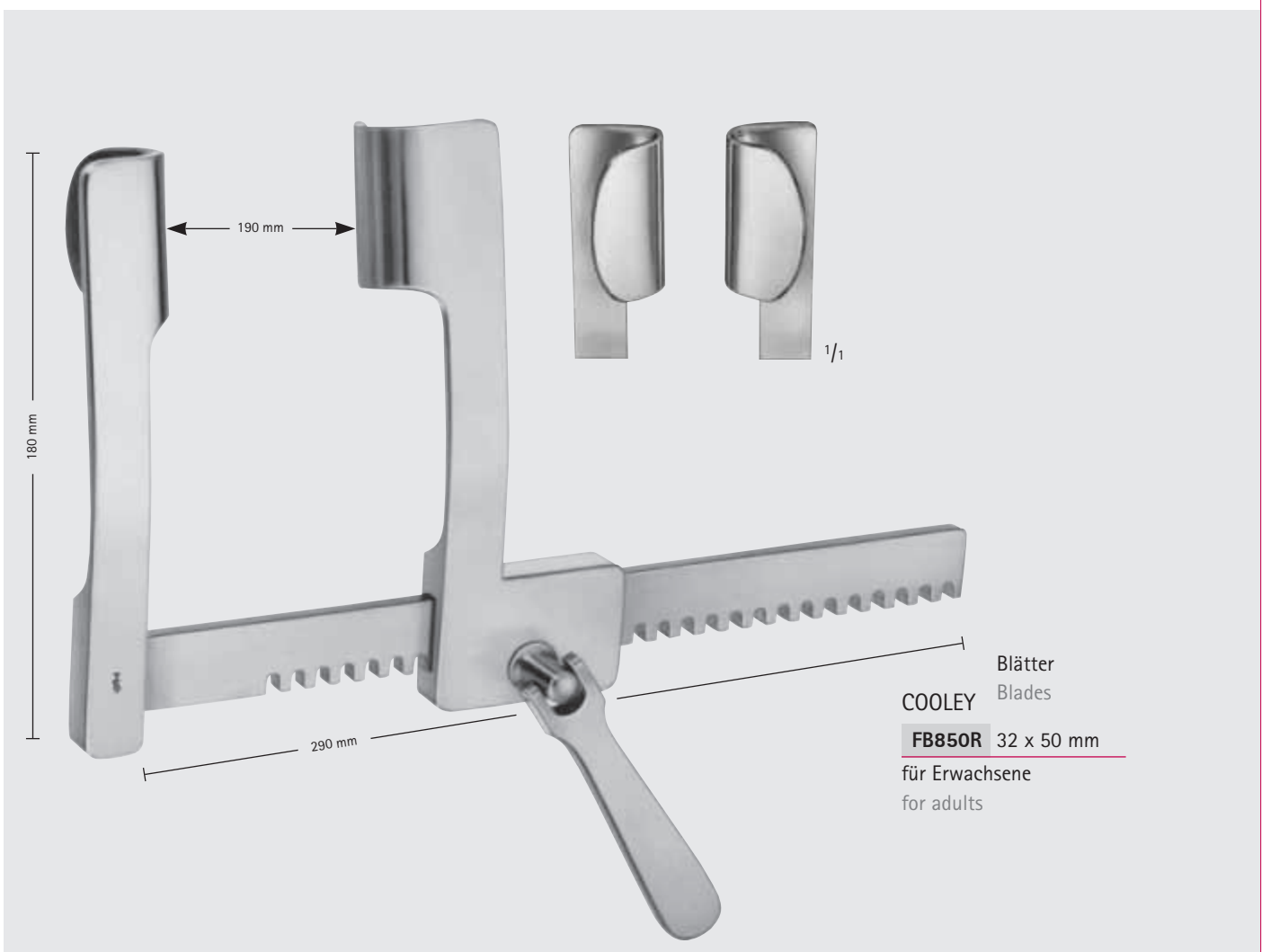
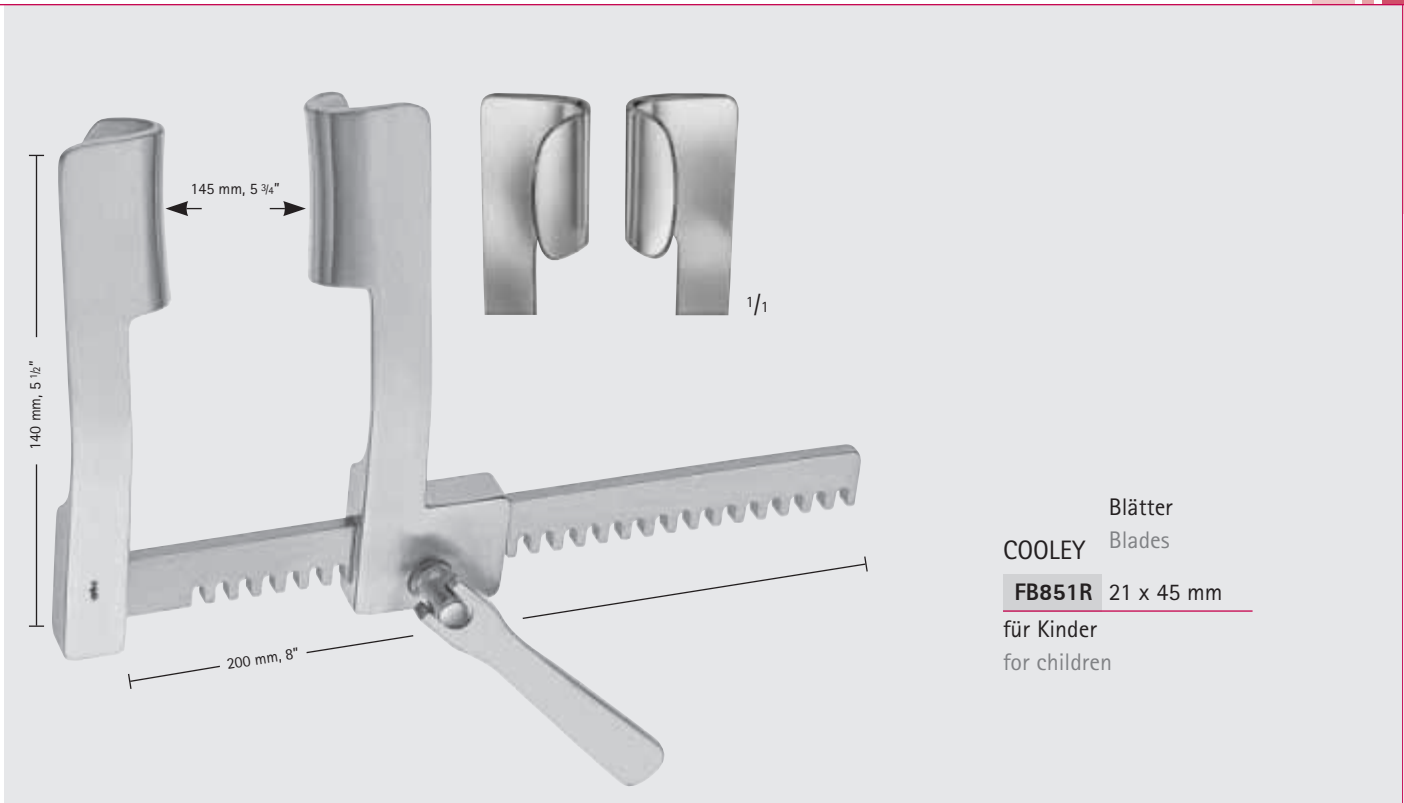

MILLIMETERS

## Herz- und Gefäß-Chirurgie – Cardiovascular Surgery

Thoraxsperrer

Thoracic Retractor

FB



**FB823R** 75 x 75 mm

Blätter

Blades



**FB822R** 42 x 65 mm

Blätter

Blades

### **FB820R**

Thoraxsperrer (Mercedes-Sperrer) komplett, bestehend aus:

FB821R Sperrer allein

FB822R Blätter (Paar)

FB823R Blätter (Paar)

Thoracic retractor (Mercedes-Retractor)

complete, consisting of:

FB821R Retractor only

FB822R Blades (pair)

FB823R Blades (pair)

## Herz- und Gefäß-Chirurgie – Cardiovascular Surgery

### Sternum-Sperrer Sternum Retractors

Der Sperrer kann optional nach kranial (Bild 2, 2a) und kaudal (Bild 1, 1a) eingesetzt werden, wobei beim Einsatz nach kranial die Aufbiegung der Arme nach oben, vom Patienten weg zeigt, um Druck auf den Hals zu vermeiden.

The spreader can be used optionally in cranial (picture 2, 2a) or caudal (picture 1, 1a) position. As the retractor is used in cranial position the bend up arms show away from the patient in order to protect the neck from pressure.

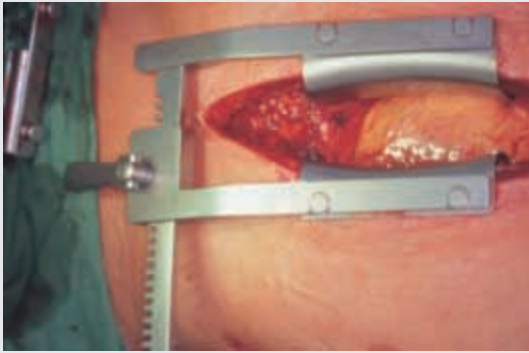

1

Einsatz als Sternumsperrer (Bild 1, 2)

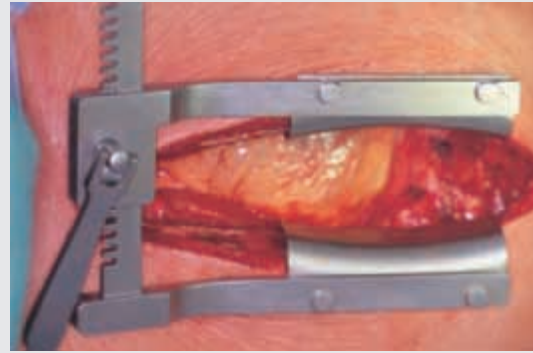

2

Used as sternum retractor (picture 1, 2)



1a

Einsatz zur Darstellung der Arteria mammaria interna (Bild 1a, 2a).

Die Seite des Sternums, auf der die Arteria mammaria interna präpariert werden soll, wird durch die Spreizwirkung des Sperrers automatisch angehoben. Das Ergebnis ist eine einfachere Präparation der Arteria mammaria interna.

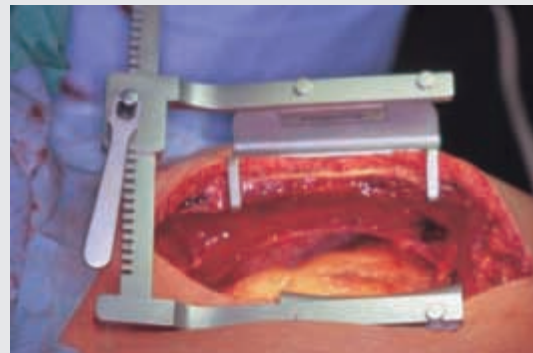

2a

Used for preparation of the arteria mammaria interna (picture 1a, 2a).

The side of the sternum, where the arteria mammaria interna shall be dissected is lifted up automatically due to the spreading effect of the retractor. The result is an easier preparation of the arteria mammaria interna.

## Herz- und Gefäß-Chirurgie – Cardiovascular Surgery

Sternum-Sperrer

Sternum Retractors

FB

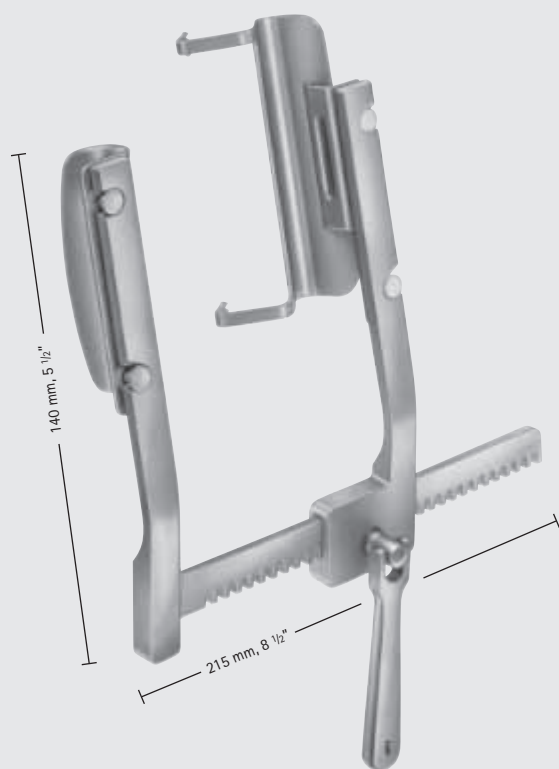

### FC060R

Mammaria Sperrer komplett,  
bestehend aus:

- FC061R Sperrer allein
- FC062R Mammariablatt, komplett mit  
Aufnahmeblatt links und rechts
- FC063R Sternumblätter (Paar)
- FC064R Sternumblätter (Paar)

Mammaria spreader complete,  
consisting of:

- FC061R Retractor only
- FC062R Mammariablade complete with  
holding blades left and right
- FC063R Sternum blades (pair)
- FC064R Sternum blades (pair)

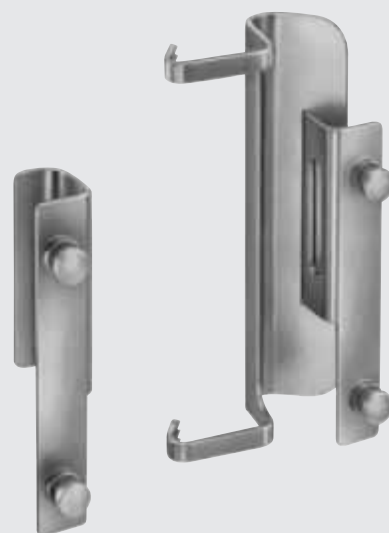

### FC062R

Mammariablatt, komplett  
Mammaria blade, complete



### FC063R 30 x 100 mm

Sternumblätter  
Sternum blades



### FC064R 40 x 100 mm

Sternumblätter  
Sternum blades





**Herz- und Gefäß-Chirurgie – Cardiovascular Surgery**  
 Rippensperrer und -Kontraktoren  
 Rib Spreaders- and Contractors

**FB**



**SELLORS**

**FB840R**

Rippensperrer und -kontraktor  
 mit drehbaren Klauen

Rib spreader- and contractor  
 with swivel blades

200 mm, 8"

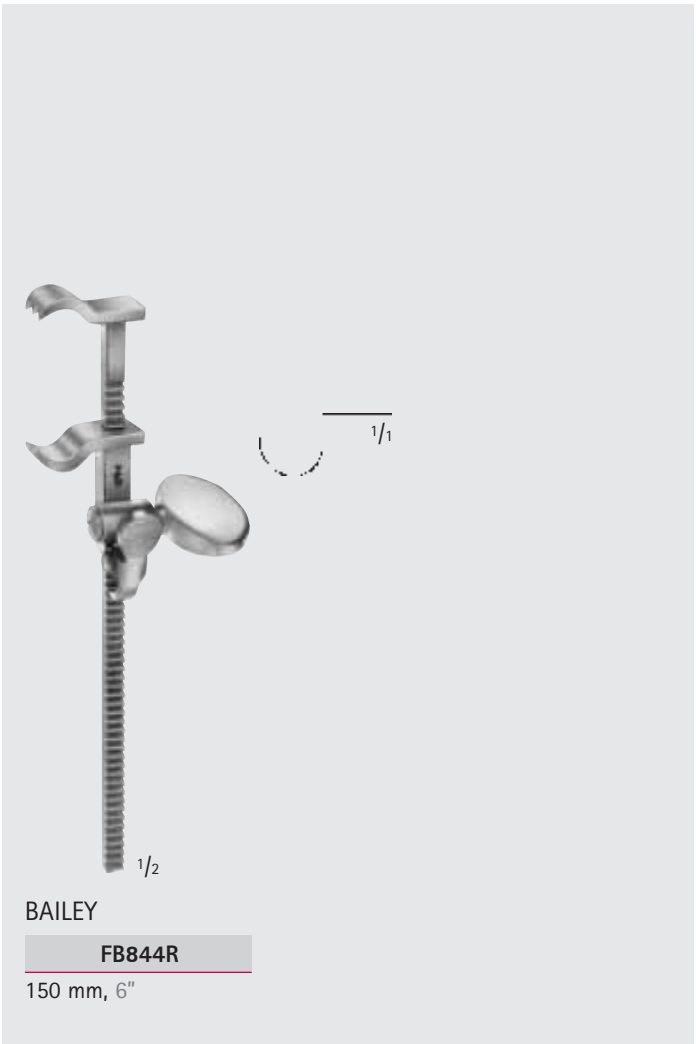

**BAILEY**

**FB844R**

150 mm, 6"



**FB841R**

für Kinder  
 for children

**FB842R**

für Erwachsene  
 for adults

**BAILEY**

**FB841R-FB842R**

200 mm, 8"

## Herz- und Gefäß-Chirurgie – Cardiovascular Surgery

Wundhaken, Lungenspatel

Retractors, Lung Spatulas

Weitere Wundhaken siehe Rubrik BT

Further retractors see section BT

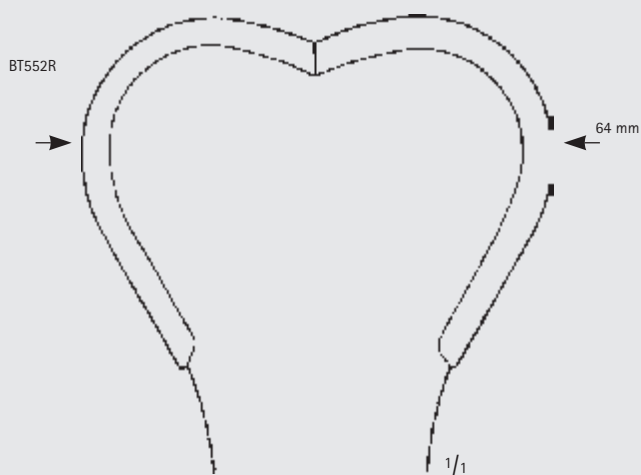
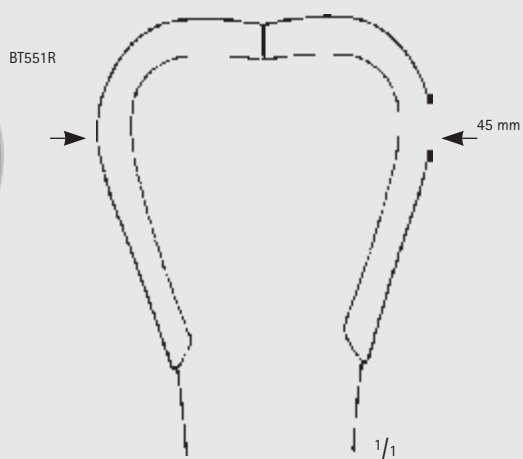

### HARRINGTON

**BT551R** 123 x 45 mm

**BT552R** 123 x 64 mm

federnd

flexible

295 mm, 11 3/4"

INCHES



## Herz- und Gefäß-Chirurgie – Cardiovascular Surgery

Wundhaken, Lungenspatel  
Retractors, Lung Spatulas

Weitere Wundhaken siehe Rubrik BT  
Further retractors see section BT



HARRINGTON-PEMBERTON

**BT553R** 175 x 64 mm

federnd

flexible

295 mm, 11 <sup>3</sup>/<sub>4</sub>"

FB



# Herz- und Gefäß-Chirurgie – Cardiovascular Surgery

Scapula-Haken

Scapula Retractor

FB

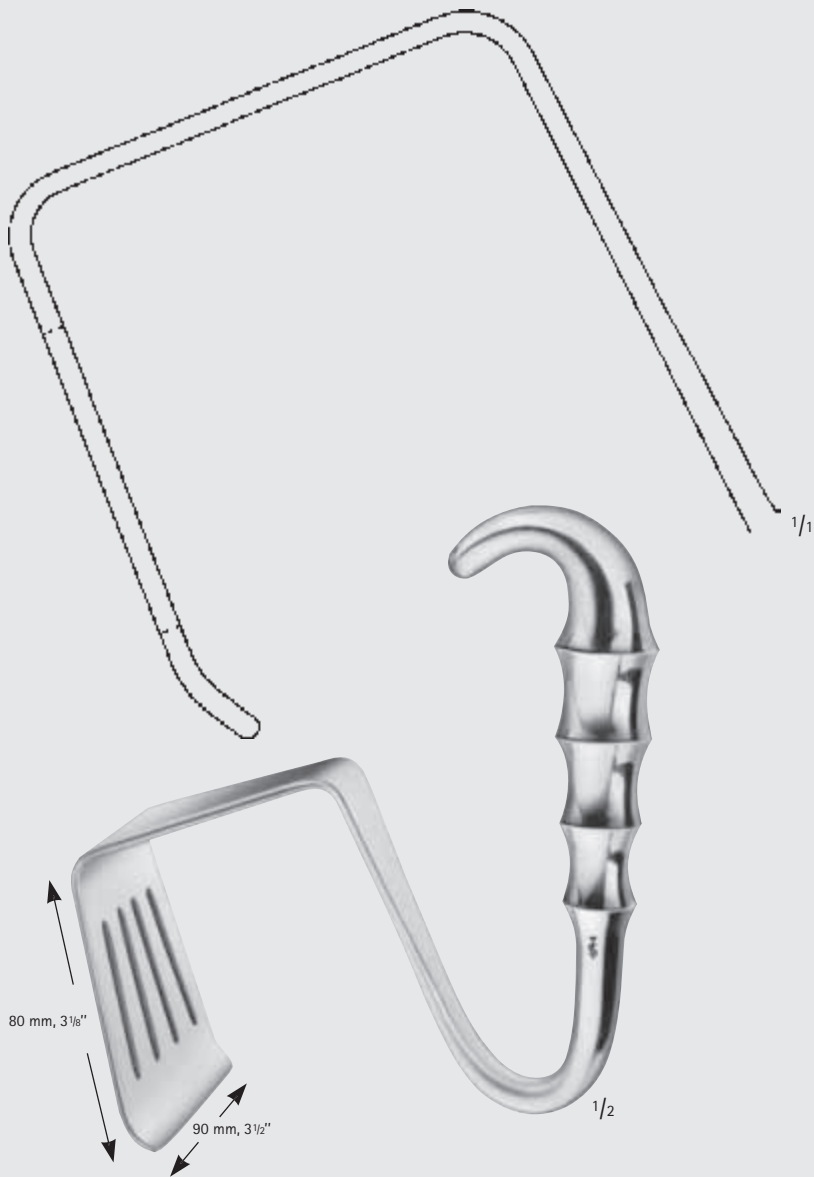

DAVIDSON

**BT531R**

195 mm, 7 3/4"



# Herz- und Gefäß-Chirurgie – Cardiovascular Surgery

Lungenspatel  
Lung Spatulas

FB



ALLISON

**BT559R**

255 mm, 10"

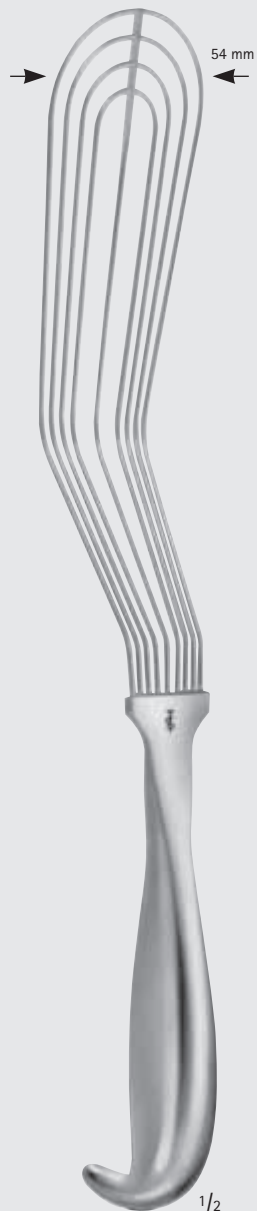

ALLISON

**BT560R**

320 mm, 12 3/4"

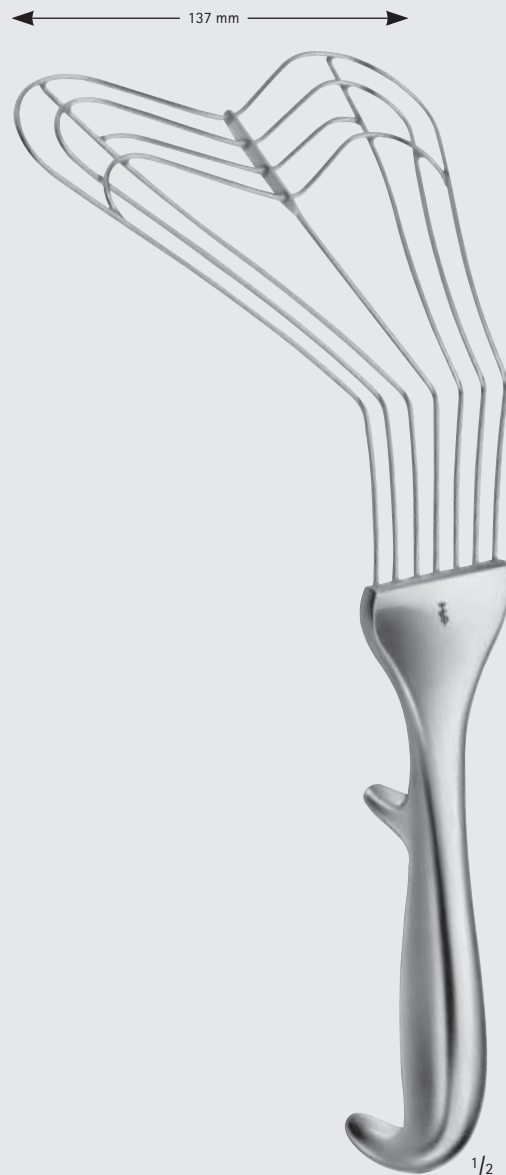

ALLISON

**BT561R**

300 mm, 12"



MILLIMETERS

# Herz- und Gefäß-Chirurgie – Cardiovascular Surgery

Atriumhaken

Atrium Retractors

FB



45 x 48 mm

COOLEY

**FB860R**

rechts  
right

270 mm, 10 <sup>3</sup>/<sub>4</sub>"



45 x 48 mm

COOLEY

**FB861R**

rechts, leicht gezahnt  
right, slightly serrated

270 mm, 10 <sup>3</sup>/<sub>4</sub>"



25 x 46 mm

COOLEY

**FB862R**

links  
left

280 mm, 11"



## Herz- und Gefäß-Chirurgie – Cardiovascular Surgery

Atriumhaken  
Atrium Retractors

FB



45 x 30 mm

1/1

COOLEY MODIF. STRUCK

**FB865R**

leicht gezahnt  
slightly serrated  
265 mm, 10 1/2"



45 x 35 mm

1/1

COOLEY MODIF. STRUCK

**FB866R**

leicht gezahnt  
slightly serrated  
265 mm, 10 1/2"

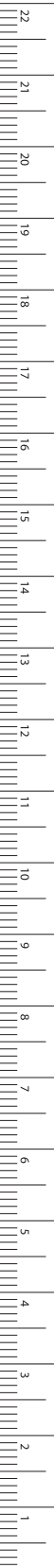

# Herz- und Gefäß-Chirurgie – Cardiovascular Surgery

## Aortenklappenhaken

### Aorta Valve Retractors

FB

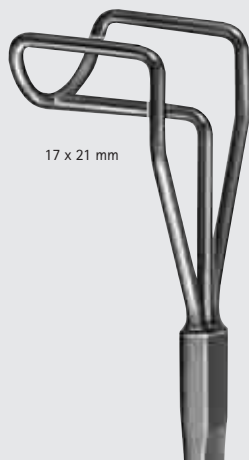

17 x 21 mm

FB971R

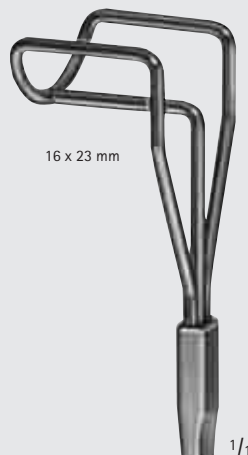

16 x 23 mm

FB972R



20 x 25 mm

FB973R

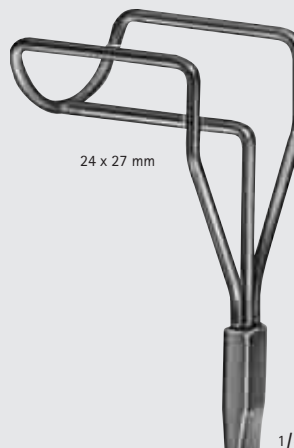

24 x 27 mm

FB974R

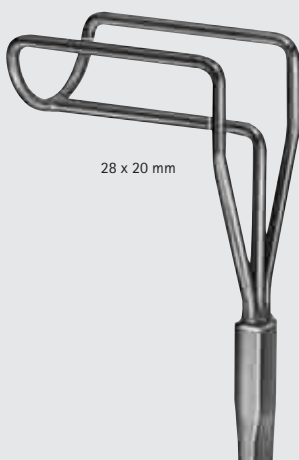

28 x 20 mm

FB975R

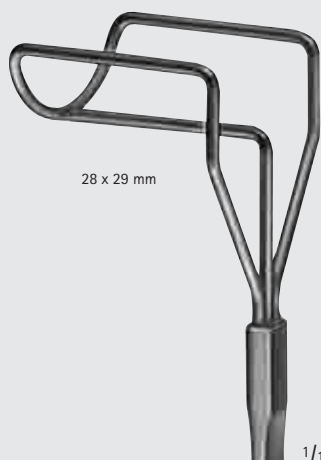

28 x 29 mm

FB976R



1/2

BOROWSKI

FB971R-FB976R

Schaft biegsam

Shaft malleable

270 mm, 10 3/4"





# Herz- und Gefäß-Chirurgie – Cardiovascular Surgery

## Saugkanülen Suction Cannulae

FB



Ø 5 mm  
diam. 5 mm

1/1

Olive Ø 9 mm  
olive diam. 9 mm

**GF947R**

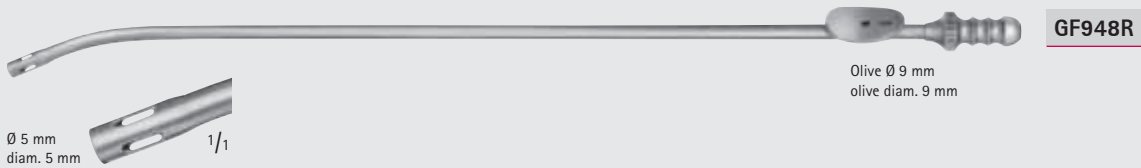

Ø 5 mm  
diam. 5 mm

1/1

Olive Ø 9 mm  
olive diam. 9 mm

**GF948R**

DE BAKEY

**GF947R** 160 mm, 6 1/4"

**GF948R** 270 mm, 10 3/4"

mit Saugunterbrecher und Mandrin  
with finger cut-off and stylet

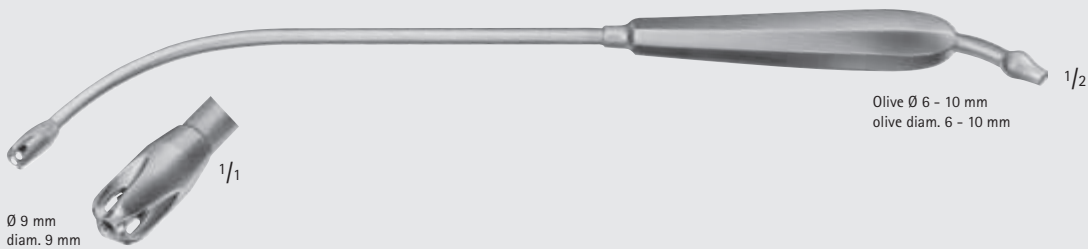

Ø 9 mm  
diam. 9 mm

1/1

Olive Ø 6 - 10 mm  
olive diam. 6 - 10 mm

1/2

DE BAKEY

**GF946R**

mit zentraler Bohrung, Ø 3,0 mm  
und seitlichen Schlitzen  
with central bore, 3.0 mm diam.  
with lateral slots  
275 mm, 10 3/4"



Ø 10 mm  
diam. 10 mm

Olive Ø 7 - 9 mm  
olive diam. 7 - 9 mm

1/2

YANKAUER

**GF944R**

mit zentraler Bohrung, Ø 2,0 mm  
with central bore, 2.0 mm diam.  
285 mm, 11 1/4"



MILLIMETERS

## Herz- und Gefäß-Chirurgie – Cardiovascular Surgery

Saugkanülen

Suction Cannula

FB

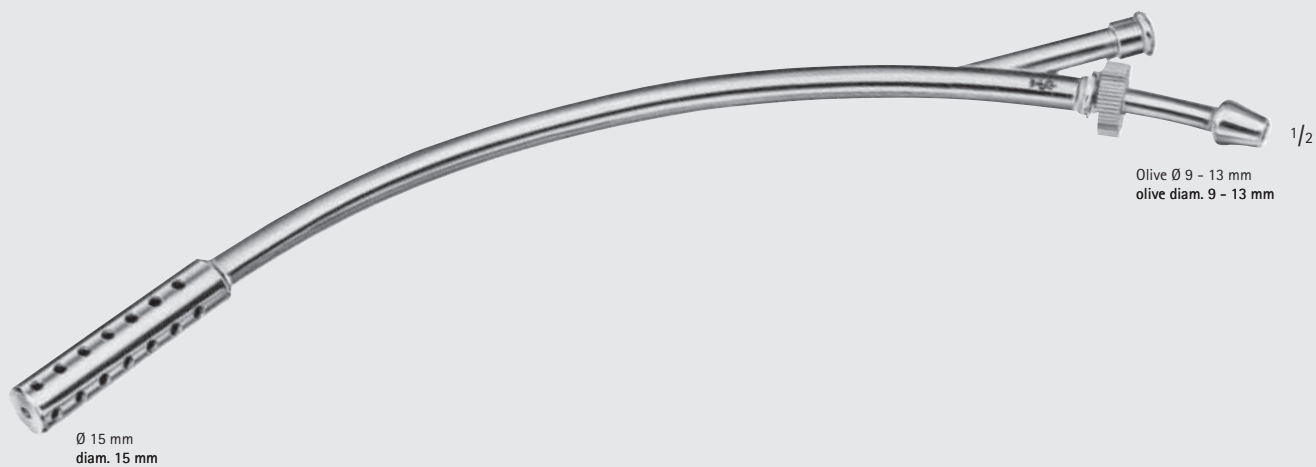

Ø 15 mm  
diam. 15 mm

Olive Ø 9 - 13 mm  
olive diam. 9 - 13 mm

1/2

FINSTERER

**GF867C**

kombinierte Saug- und Spülkanüle

combined suction- and irrigation cannula

320 mm, 12 3/4"



# Herz- und Gefäß-Chirurgie – Cardiovascular Surgery

## Venen-Stripper-Instrumente

### Vein Stripper Instruments

FB

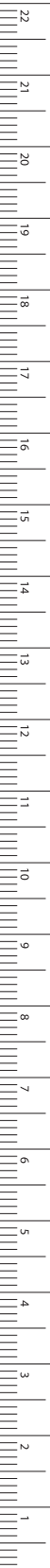

Ersatzteile für FB030R  
Spare parts for FB030R



NABATOFF

**FB033**

Kunststoff-Sondenspitze  
Flexible plastic probe tip



NABATOFF

1/1

Ø  
diam.

**FB034R** 3 mm

Metall-Sondenspitze  
Probe tip, metal



NABATOFF

**FB030R**

Venenstripper-Besteck, bestehend aus:

- FB031R Metalletui
- FB032R Zugseil, 900 mm lang
- FB033 Kunststoff-Sondenspitze
- FB034R Metall-Sondenspitze
- FB035R Metallolive, Ø 6 mm
- FB036R Metallolive, Ø 9 mm
- FB037R Metallolive, Ø 12 mm
- FB038R Metallolive, Ø 15 mm
- FB040R Griff für Zugseil

Vein stripper set, consisting of:

- FB031R Metal case
- FB032R Flexible cable, 36" long
- FB033 Flexible plastic probe tip
- FB034R Metal probe tip
- FB035R Metal olive, diam. 6 mm
- FB036R Metal olive, diam. 9 mm
- FB037R Metal olive, diam. 12 mm
- FB038R Metal olive, diam. 15 mm
- FB040R Handle for flexible cable

NABATOFF

Ø  
diam.

**FB035R** 6 mm

**FB036R** 9 mm

**FB037R** 12 mm

**FB038R** 15 mm

Oliven allein

Olives only



**FB035R**



**FB036R**



**FB037R**



**FB038R**

1/1



NABATOFF

**FB040R**

Griff allein

Handle only



**FB032R**

Zugseil  
Flexible cable  
900 mm, 36"

MILLIMETERS

# Herz- und Gefäß-Chirurgie – Cardiovascular Surgery

## Varizeninstrumente

### Varix Instruments

FB

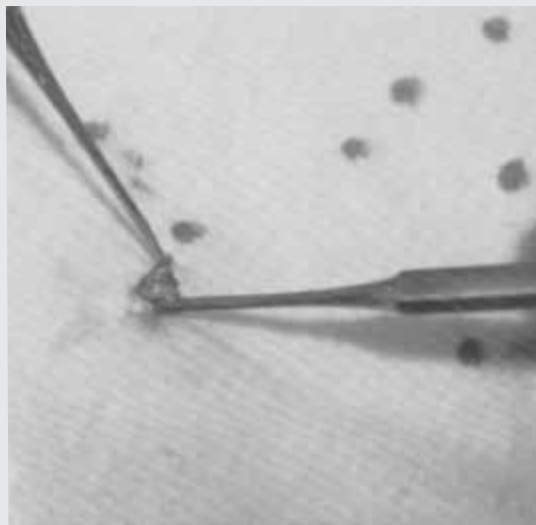

#### VARADY

##### FB050R

Mini-Venenstripper-Set, bestehend aus:

- FB031R Metalletui
- FB051R Zugseil, 450 mm lang, kunststoffummantelt
- FB053R Metallolive, Ø 3 mm
- FB054R Metallolive, Ø 4 mm
- FB055R Metallolive, Ø 5 mm

Mini vein stripper set, consisting of:

- FB031R Metal case
- FB051R Flexible cable, 17 1/2" long, polyethylene coating
- FB053R Metal olive, diam. 3 mm
- FB054R Metal olive, diam. 4 mm
- FB055R Metal olive, diam. 5 mm

Ersatzteile für FB050R  
Spare parts for FB050R

#### VARADY

Ø  
diam.

<b>FB053R</b>	3 mm
<b>FB054R</b>	4 mm
<b>FB055R</b>	5 mm

Oliven allein  
Olives only



**FB053R**



**FB054R**

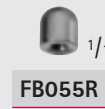

**FB055R** 1/1



#### VARADY

##### FB051R

Zugseil, kunststoffummantelt  
Cable, flexible, polyethylene coating  
450 mm, 17 1/2"



## Herz- und Gefäß-Chirurgie – Cardiovascular Surgery

Varizeninstrumente

Varix Instruments

FB

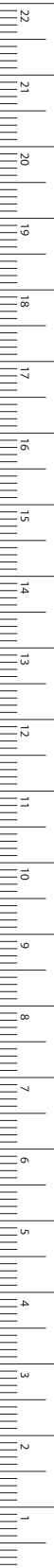

MILLIMETERS



1/2

VARADY

**FB120R**

Phlebodissektor

Phlebodissektor

180 mm, 7"

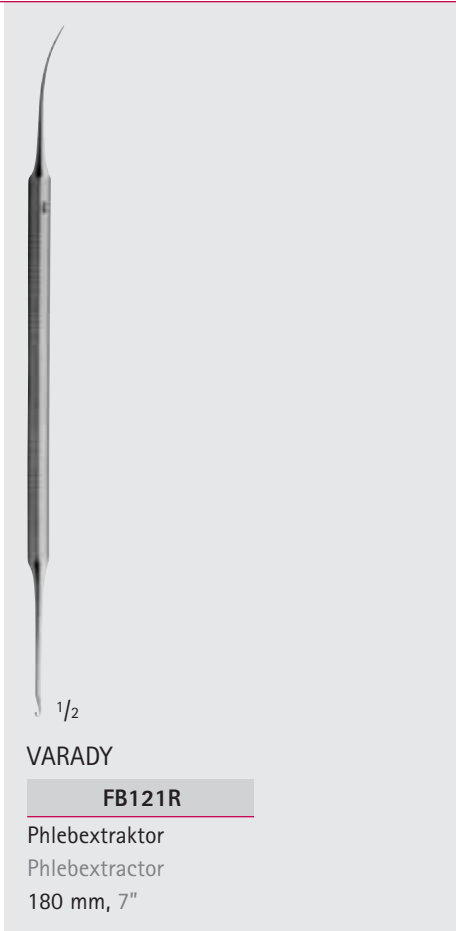

1/2

VARADY

**FB121R**

Phlebextractor

Phlebextractor

180 mm, 7"

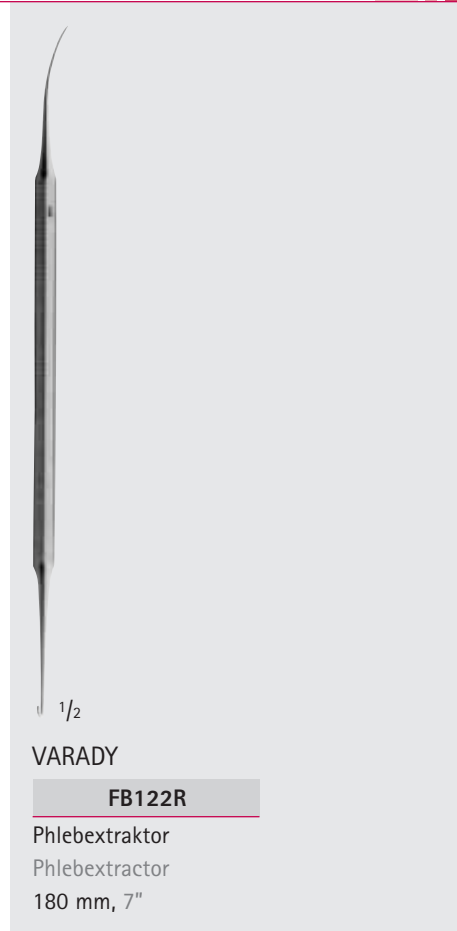

1/2

VARADY

**FB122R**

Phlebextractor

Phlebextractor

180 mm, 7"



1/2

VARADY

**FB124R**

Mikro-Doppelspatel

Micro spatula, double ended

175 mm, 7"



1/2

VARADY

**FB125R**

Mikro-Phlebextractor

Micro phlebextractor

170 mm, 6 3/4"



1/2

VARADY

**FB126R**

Mini-Phlebextractor

Mini phlebextractor

170 mm, 6 3/4"

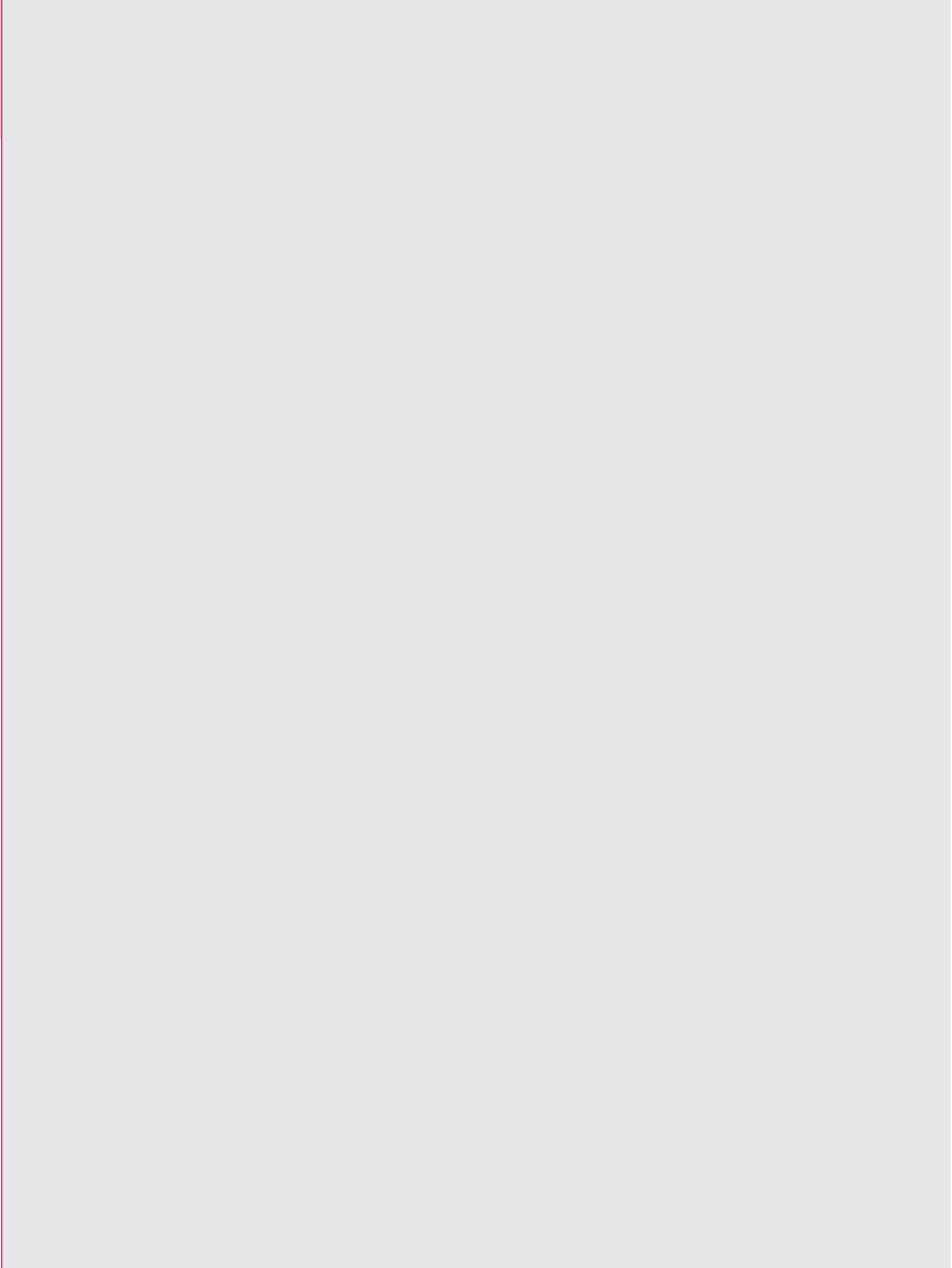

FF



**Knochenstanzen, Rongeurs**  
Bone Punches, Rongeurs

# Knochenstanzen, Rongeurs – Bone Punches, Rongeurs

Stanzen  
Punches

Winkelstellungen bei Stanzen  
Angled positions for punches

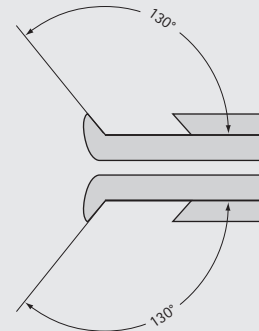
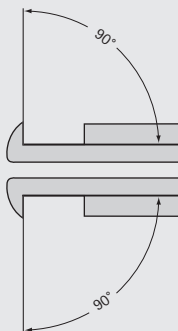
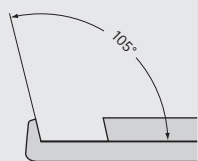

90° nach oben schneidend  
upwards cutting

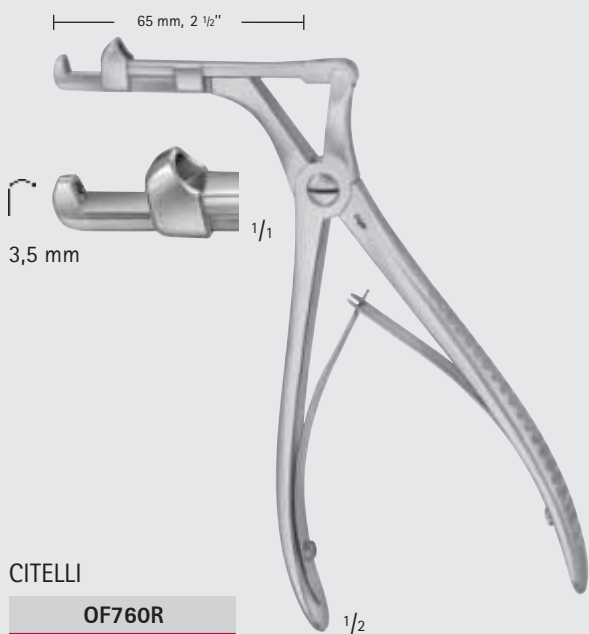

CITELLI

**OF760R**

90° nach oben schneidend  
upwards cutting

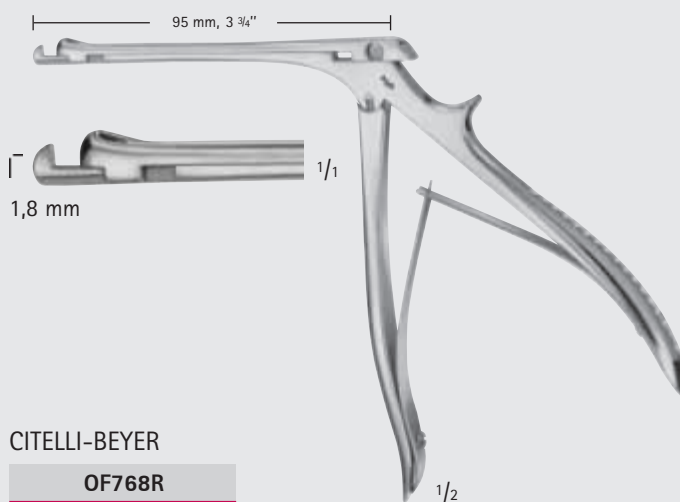

CITELLI-BEYER

**OF768R**

90° nach oben schneidend  
upwards cutting

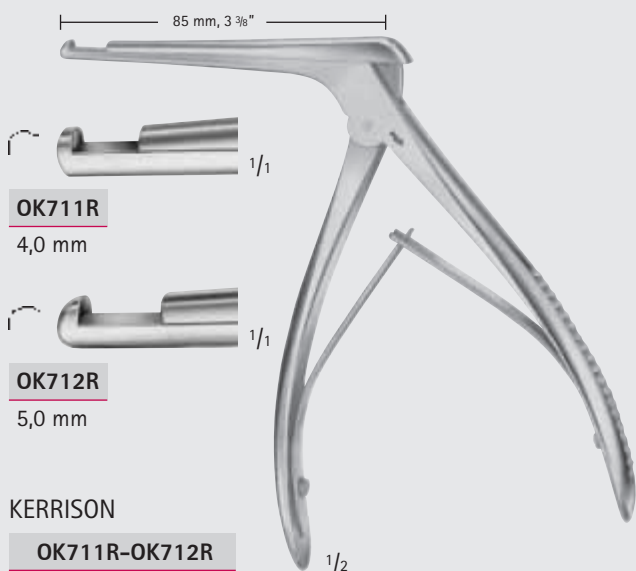

**OK711R**

4,0 mm

**OK712R**

5,0 mm

KERRISON

**OK711R-OK712R**

FF







## Knochenstanzen, Rongeurs – Bone Punches, Rongeurs

Stanzen  
Punches

FF

90° nach oben schneidend  
upwards cutting

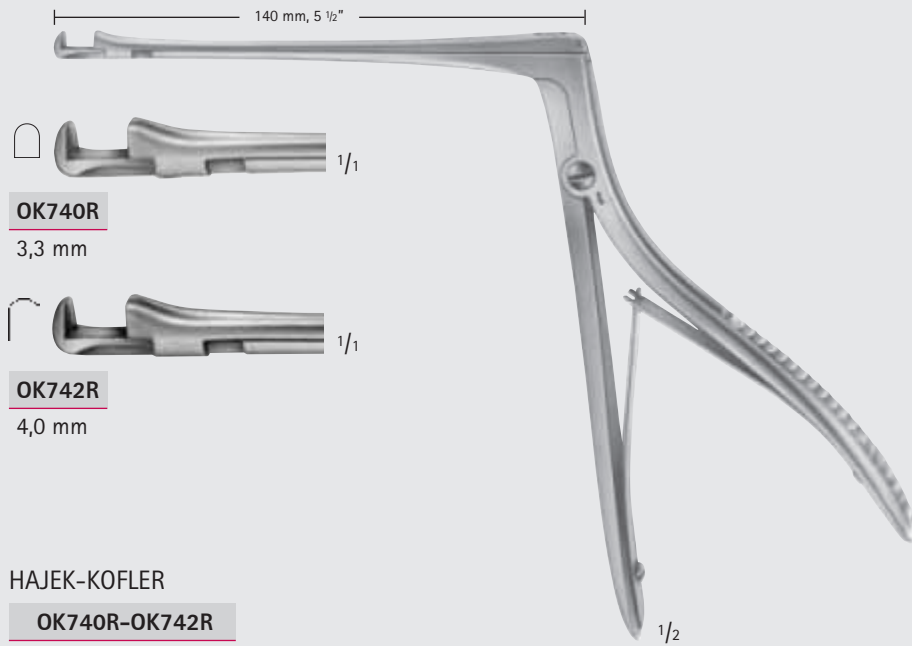

HAJEK-KOFLER

OK740R-OK742R

90° nach unten schneidend  
downwards cutting

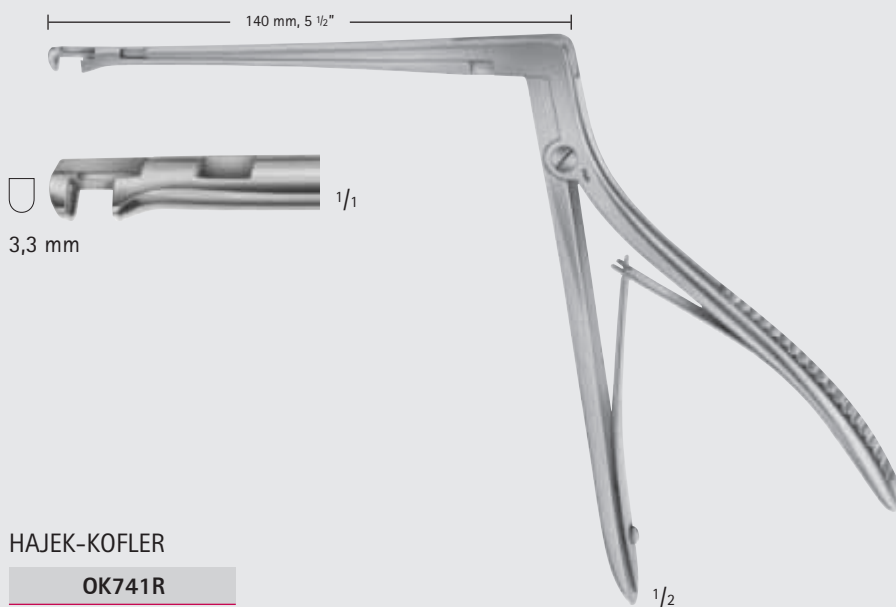

HAJEK-KOFLER

OK741R



MILLIMETERS

## Knochenstanzen, Rongeurs – Bone Punches, Rongeurs

Stanzen  
Punches

90° drehbar 360°  
rotates 360°

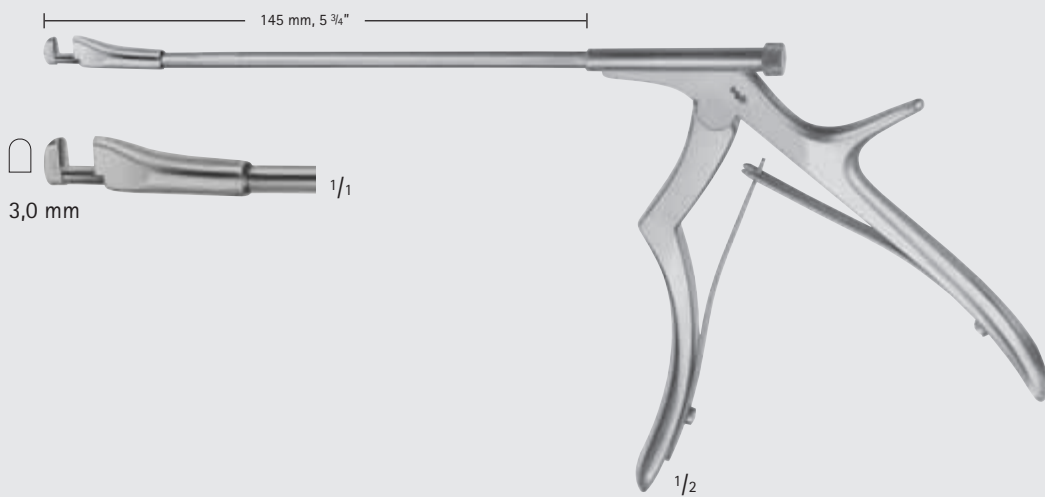

KOFLER

OK737R

90° drehbar 360°  
rotates 360°

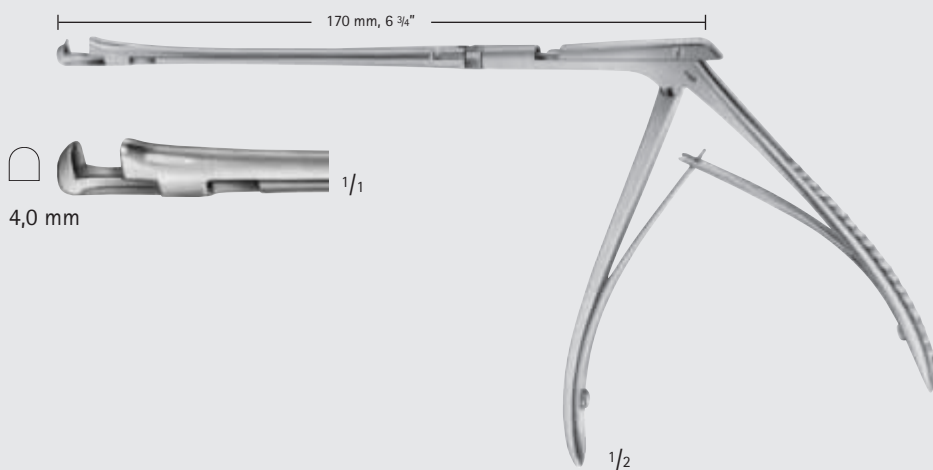

HAJEK-KOFLER

OK745R



# Knochenstanzen, Rongeurs – Bone Punches, Rongeurs

Stanzen  
Punches

FF

130° nach oben schneidend  
upwards cutting

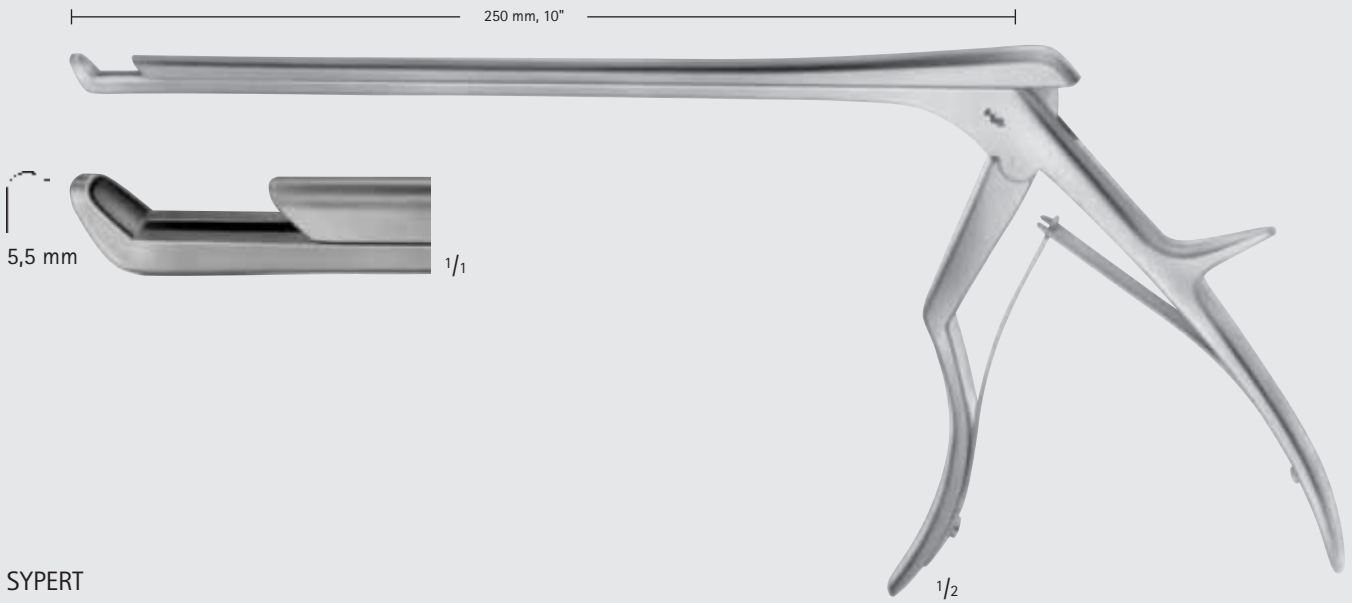

SYPERT

FG055R

MILLIMETERS

# Knochenstanzen, Rongeurs – Bone Punches, Rongeurs

KERRISON Knochenstanzen

KERRISON Bone Punches

**90° nach oben schneidend**  
upwards cutting



Regular



**90° oben**  
90° upwards

STANDARD nicht zerlegbar ohne Ejektor non detachable without ejector	zerlegbar detachable	Ejektor Ejector	NOIR zerlegbar detachable	Ejektor Ejector
--	-------------------------	--------------------	---------------------------------	--------------------

Schaftlänge Shaft length	Breite Width	Fußplatte Footplate					
180 mm, 7"	1,0 mm	regular	<b>FF716R</b>	<b>FK948R</b>	-	<b>FK948B</b>	-
	2,0 mm	regular	<b>FF718R</b>	<b>FK949R</b>	-	<b>FK949B</b>	-
	3,0 mm	regular	<b>FF750R</b>	<b>FK950R</b>		<b>FK950B</b>	
	4,0 mm	regular	<b>FF752R</b>	<b>FK951R</b>		<b>FK951B</b>	
	5,0 mm	regular	<b>FF754R</b>	<b>FK952R</b>		<b>FK952B</b>	
	6,0 mm	regular	<b>FF755R</b>	<b>FK953R</b>		<b>FK953B</b>	

**90° nach unten schneidend**  
downwards cutting



Regular



**90° unten**  
90° downwards

STANDARD nicht zerlegbar, ohne Ejektor non detachable, without ejector	zerlegbar detachable	Ejektor Ejector
--	-------------------------	--------------------

Schaftlänge Shaft length	Breite Width	Fußplatte Footplate			
180 mm, 7"	1,0 mm	regular	<b>FF741R</b>	<b>FK954R</b>	-
	2,0 mm	regular	<b>FF719R</b>	<b>FK955R</b>	-
	3,0 mm	regular	<b>FF721R</b>	<b>FK956R</b>	
	4,0 mm	regular	<b>FF742R</b>	<b>FK957R</b>	
	5,0 mm	regular	<b>FF723R</b>	<b>FK958R</b>	
	6,0 mm	regular	<b>FF743R</b>	<b>FK959R</b>	



## Knochenstanzen, Rongeurs – Bone Punches, Rongeurs

KERRISON Knochenstanzen

KERRISON Bone Punches

**130°** nach oben schneidend  
upwards cutting



Regular

Thin

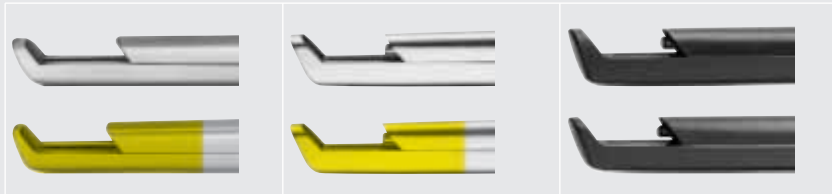

**130° oben**  
130° upwards

**130° oben**  
130° upwards

**130° oben**  
130° upwards

STANDARD  
nicht zerlegbar  
ohne Ejektor  
non detachable  
without ejector

zerlegbar  
detachable

Ejektor  
Ejector

NOIR  
zerlegbar  
detachable

Ejektor  
Ejector

Schaftlänge Shaft length	Breite Width	Fußplatte Footplate					
180 mm, 7"	1,0 mm	regular	FF715R	FK900R	-	FK900B	-
	2,0 mm	regular	FF717R	FK901R	-	FK901B	-
	3,0 mm	regular	FF720R	FK902R	☐	FK902B	☐
	4,0 mm	regular	FF724R	FK903R	☐	FK903B	☐
	5,0 mm	regular	FF722R	FK904R	☐	FK904B	☐
	6,0 mm	regular	FF726R	FK905R	☐	FK905B	☐
200 mm, 8"	2,0 mm	regular	FF737R	FK913R	-	FK913B	-
	3,0 mm	regular	FF738R	FK914R	☐	FK914B	☐
	4,0 mm	regular	FF727R	FK915R	☐	FK915B	☐
	5,0 mm	regular	FF728R	FK916R	☐	FK916B	☐
	6,0 mm	regular	FF729R	FK917R	☐	FK917B	☐
230 mm, 9"	2,0 mm	regular	FF682R	FK919R	-		
	3,0 mm	regular	FF683R	FK920R	☐		
	4,0 mm	regular	FF684R	FK921R	☐		
	5,0 mm	regular	FF685R	FK922R	☐		
180 mm, 7"	1,0 mm	thin	FF771R	FK906R	-	FK906B	-
	2,0 mm	thin	FF772R	FK907R	-	FK907B	-
	3,0 mm	thin	FF773R	FK908R	☐	FK908B	☐
	4,0 mm	thin	FF769R	FK909R	☐	FK909B	☐
	5,0 mm	thin	FF770R	FK910R	☐	FK910B	☐
200 mm, 8"	1,0 mm	thin	FF661R	FK961R	-	FK961B	-
	2,0 mm	thin	FF662R	FK962R	-	FK962B	-
	3,0 mm	thin	FF663R	FK963R	☐	FK963B	☐
	4,0 mm	thin	FF664R	FK964R	☐	FK964B	☐
	5,0 mm	thin	FF665R	FK965R	☐	FK965B	☐
230 mm, 9"	2,0 mm	thin	FF746R	FK925R	-	FK925B	-
	3,0 mm	thin	FF747R	FK926R	☐	FK926B	☐
	4,0 mm	thin	FF748R	FK927R	☐	FK927B	☐
	5,0 mm	thin	FF749R	FK928R	☐	FK928B	☐

FF

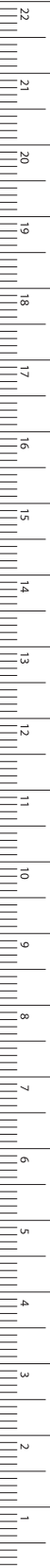

MILLIMETERS

# Knochenstanzen, Rongeurs – Bone Punches, Rongeurs

KERRISON Knochenstanzen

KERRISON Bone Punches

130° nach unten schneidend  
downwards cutting



Regular

Thin



130° unten  
130° downwards

130° unten  
130° downwards

STANDARD  
nicht zerlegbar  
ohne Ejektor  
non detachable  
without ejector

zerlegbar  
detachable

Ejektor  
Ejector

Schaftlänge Shaft length	Breite Width	Fußplatte Footplate			
180 mm, 7"	1,0 mm	regular	FF711R	FK930R	-
	2,0 mm	regular	FF712R	FK931R	-
	3,0 mm	regular	FF713R	FK932R	
	4,0 mm	regular	FF714R	FK933R	
	5,0 mm	regular	FF725R	FK934R	
230 mm, 9"	2,0 mm	regular	FF692R	FK943R	-
	3,0 mm	regular	FF693R	FK944R	
	4,0 mm	regular	FF694R	FK945R	
	5,0 mm	regular	FF695R	FK946R	
180 mm, 7"	1,0 mm	thin	FF781R	FK936R	-
	2,0 mm	thin	FF782R	FK937R	-
	3,0 mm	thin	FF783R	FK938R	
	4,0 mm	thin	FF784R	FK939R	
	5,0 mm	thin	FF785R	FK940R	

FF



INCHES



# Knochenstanzen, Rongeurs – Bone Punches, Rongeurs

Rongeurs  
Rongeurs

Winkelstellungen bei Rongeurs  
Angled positions for rongeurs

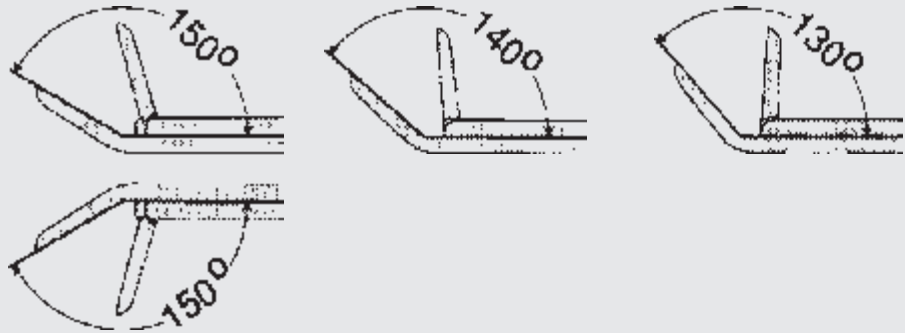

FF

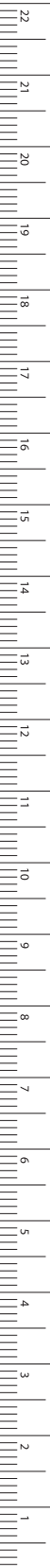

**OK505R**

3,0 mm



**OK506R**

3,6 mm



**OK507R**

4,2 mm



**OK508R**

4,8 mm



**OK509R**

5,6 mm

1/1

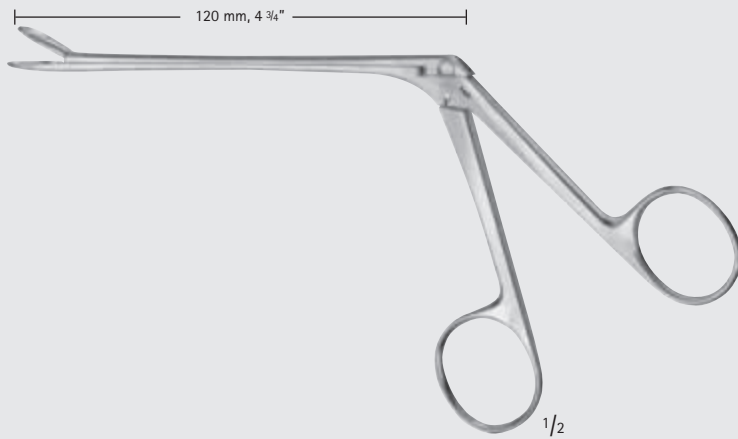

WEIL-BLAKESLEY

**OK505R-OK509R**

1/2

140°



**OK520R**

3,6 mm



**OK521R**

4,2 mm



**OK522R**

4,8 mm

1/1

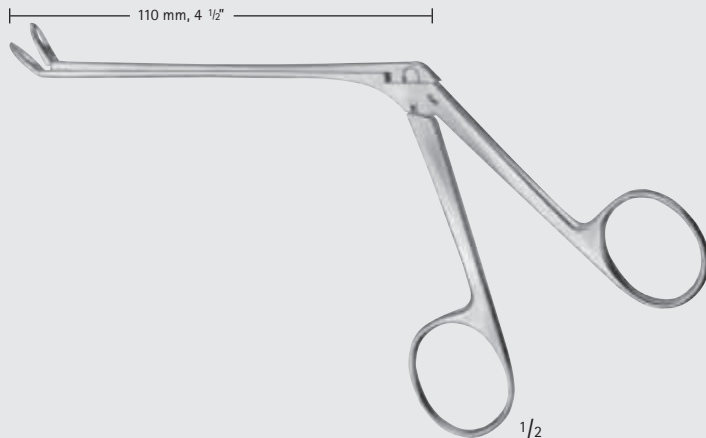

WEIL-BLAKESLEY

**OK520R-OK522R**

1/2

MILLIMETERS

## Knochenstanzen, Rongeurs – Bone Punches, Rongeurs

Rongeurs

Rongeurs

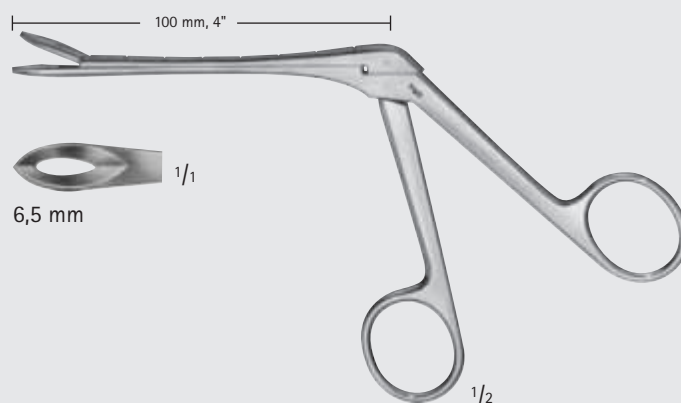

HENCKEL-TILLEY

**OK503R**

Schaft graduiert in cm

Shaft graduated in cm

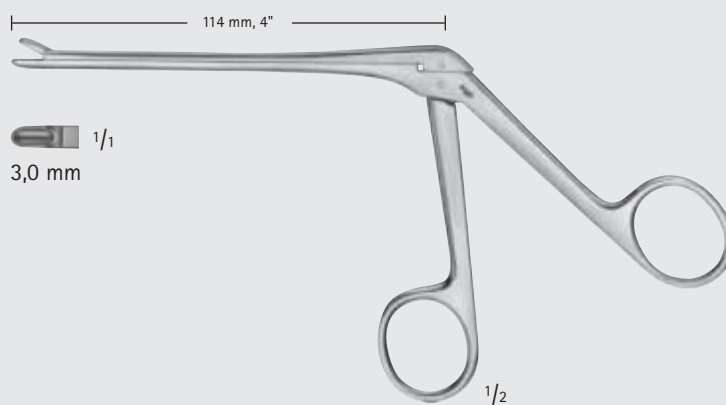

ST. BARTS

**OK536R**

140°

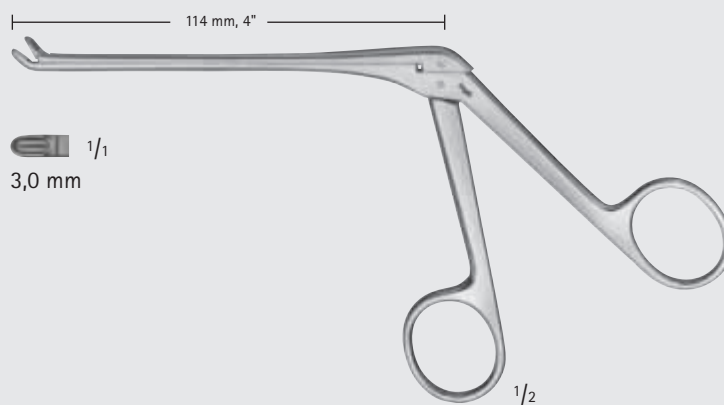

ST. BARTS

**OK537R**

FF







# Knochenstanzen, Rongeurs – Bone Punches, Rongeurs

Rongeurs  
Rongeurs

FF

140°

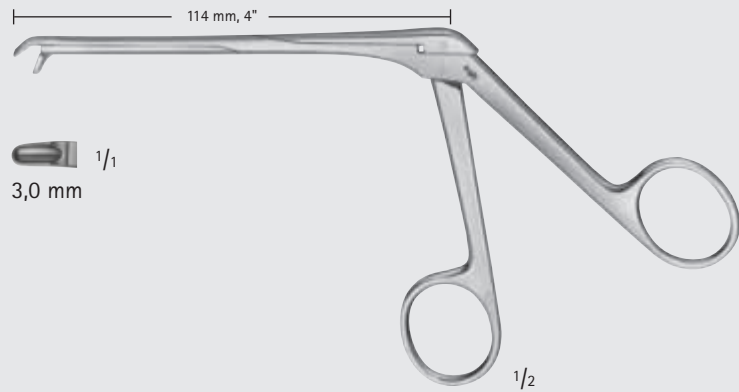

ST. BARTS

OK538R

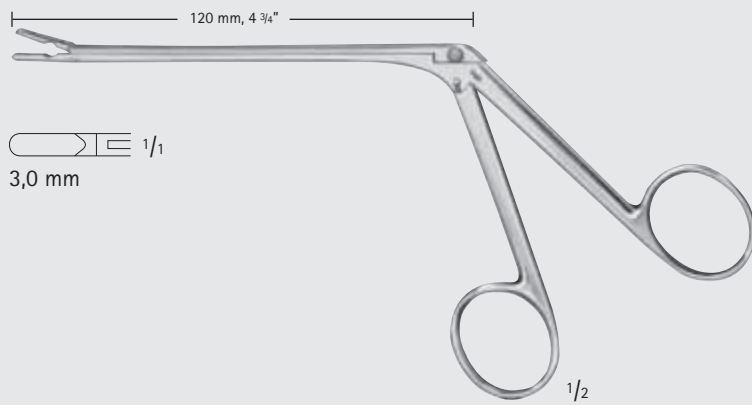

TAKAHASHI

OK525R

130°

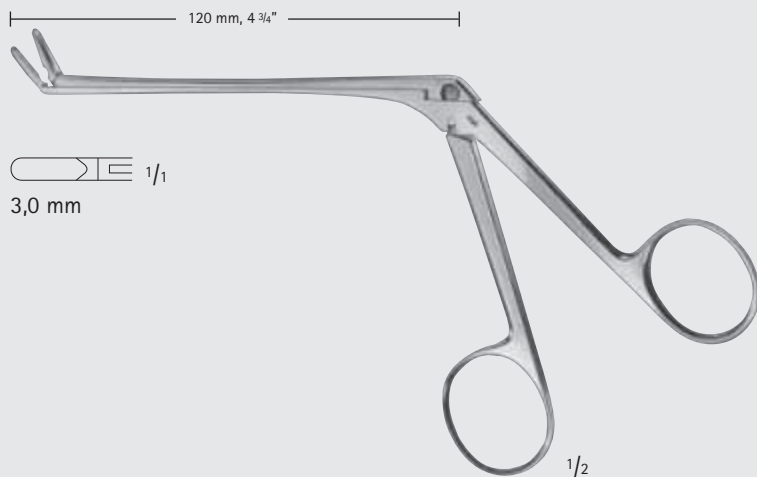

TAKAHASHI

OK526R



MILLIMETERS

## Knochenstanzen, Rongeurs – Bone Punches, Rongeurs

Rongeurs

Rongeurs

FF

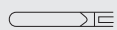

LOVE-GRUENWALD

**FF799R**

2 x 10 mm

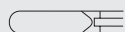

LOVE-GRUENWALD

**FF800R**

3 x 10 mm

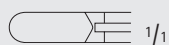

SPURLING

**FF801R**

4 x 10 mm

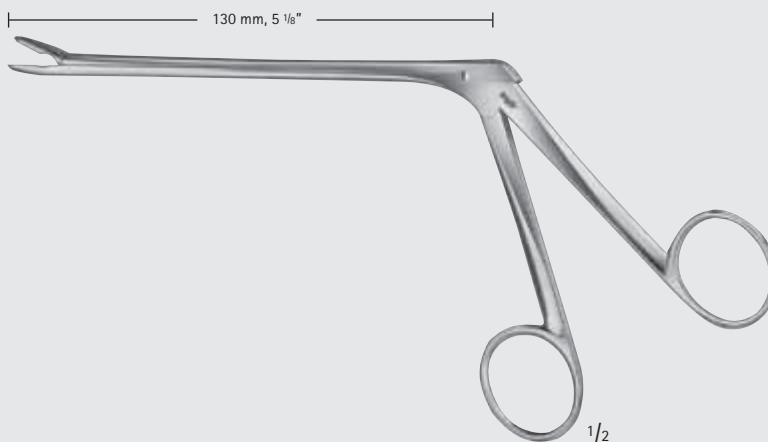

**FF799R-FF810R**

2,0 mm  
1/1

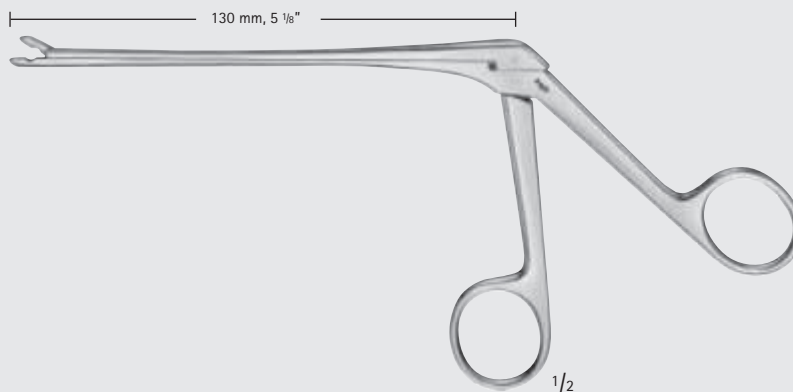

BECK

**FF765R**

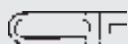

**FF766R**

4,0 mm



**FF767R**

5,0 mm

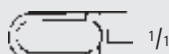

**FF768R**

6,0 mm

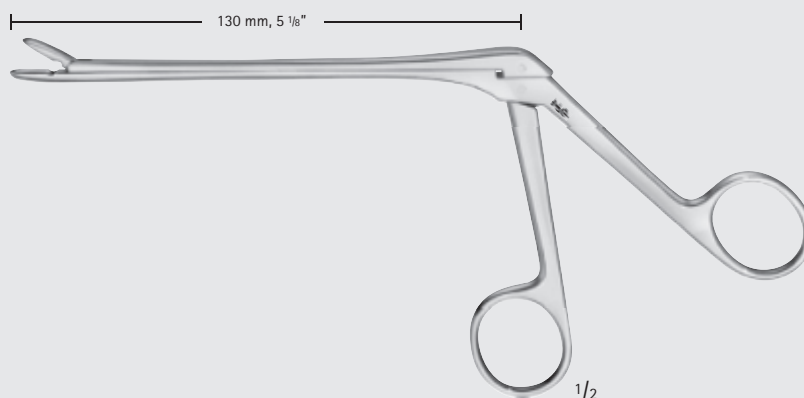

CUSHING

**FF766R-FF768R**

INCHES



# Knochenstanzen, Rongeurs – Bone Punches, Rongeurs

Rongeurs  
Rongeurs

FF

150°

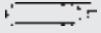

**FF774R**

3,0 mm



**FF775R**

4,0 mm

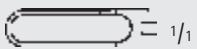

**FF776R**

5,0 mm

130 mm, 5 1/8"

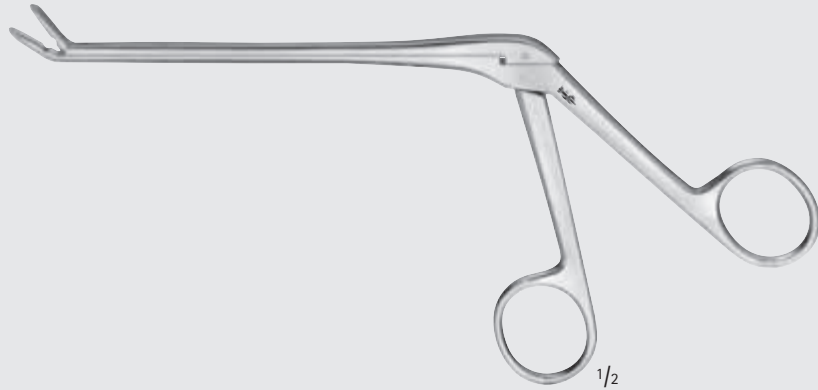

CUSHING

**FF774R-FF776R**

150°

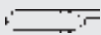

**FF777R**

3,0 mm



**FF778R**

4,0 mm

130 mm, 5 1/8"



CUSHING

**FF777R-FF778R**

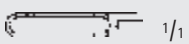

3,0 mm

125 mm, 5"



PENNYBACKER

**FF779R**



MILLIMETERS

## Knochenstanzen, Rongeurs – Bone Punches, Rongeurs

Rongeurs

Rongeurs

FF

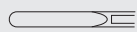

**FF832R**

2,0 mm



**FF833R**

3,0 mm



**FF834R**

4,0 mm

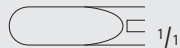

**FF835R**

5,0 mm

150 mm, 6"



CASPAR

**FF832R-FF835R**

150°

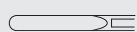

**FF842R**

2,0 mm



**FF843R**

3,0 mm

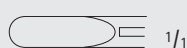

**FF844R**

4,0 mm

150 mm, 6"



CASPAR

**FF842R-FF844R**

150° unteres Maulteil beweglich  
lower part of jaw movable

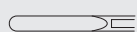

**FF852R**

2,0 mm



**FF853R**

3,0 mm

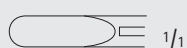

**FF854R**

4,0 mm

150 mm, 6"



CASPAR

**FF852R-FF854R**

INCHES



# Knochenstanzen, Rongeurs – Bone Punches, Rongeurs

Rongeurs  
Rongeurs



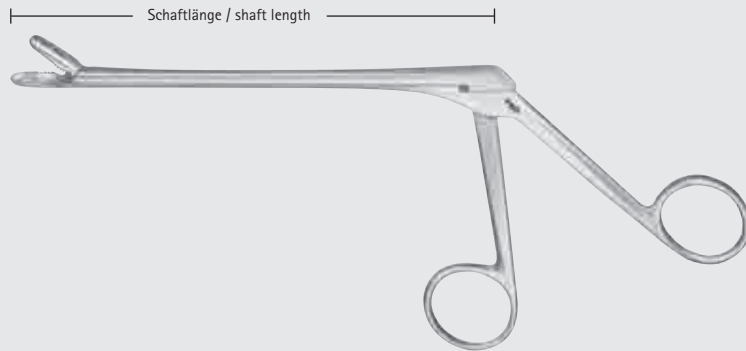

FF



CASPAR

**FF502R-FF566R**

Maulgröße  
Jaw size

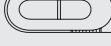
Schaftlänge Shaft length	 2 x 12 mm	 3 x 12 mm	 4 x 14 mm	 5 x 14 mm	 6 x 16 mm
140 mm, 5 1/2"	<b>FF502R</b>	<b>FF503R</b>	<b>FF504R</b>		
160 mm, 6 1/4"	<b>FF532R</b>	<b>FF533R</b>	<b>FF534R</b>	<b>FF535R</b>	<b>FF536R</b>
185 mm, 7 1/4"	<b>FF562R</b>	<b>FF563R</b>	<b>FF564R</b>	<b>FF565R</b>	<b>FF566R</b>

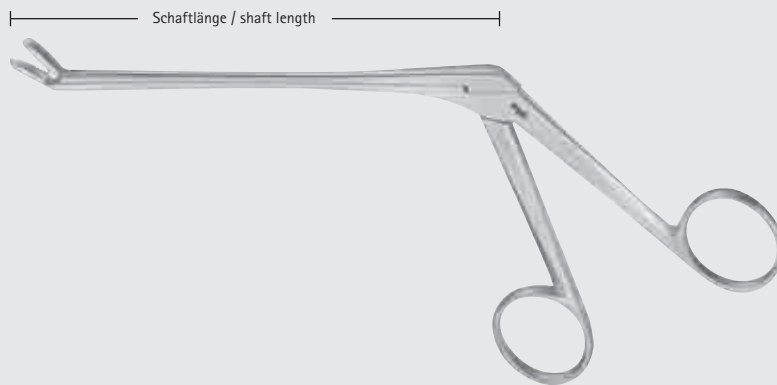

150°



CASPAR

**FF513R-FF575R**

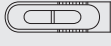
Maulgröße  
Jaw size

Schaftlänge Shaft length	 3 x 12 mm	 4 x 14 mm	 5 x 14 mm
140 mm, 5 1/2"	<b>FF513R</b>	<b>FF514R</b>	
160 mm, 6 1/4"	<b>FF543R</b>	<b>FF544R</b>	<b>FF545R</b>
185 mm, 7 1/4"	<b>FF573R</b>	<b>FF574R</b>	<b>FF575R</b>



MILLIMETERS

# Knochenstanzen, Rongeurs – Bone Punches, Rongeurs

Rongeurs

Rongeurs

150° unteres Maulteil beweglich

lower part of jaw movable

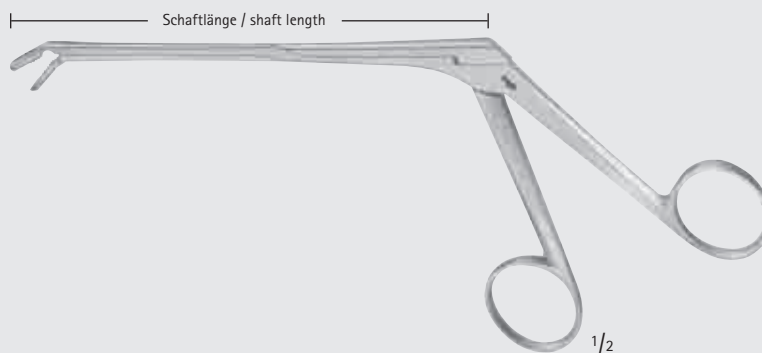



CASPAR

**FF523R-FF584R**

Maulgröße

Jaw size

Schaftlänge Shaft length	 1/1	 1/1
3 x 12 mm		
4 x 14 mm		
140 mm, 5 1/2"	<b>FF523R</b>	<b>FF524R</b>
160 mm, 6 1/4"	<b>FF553R</b>	<b>FF554R</b>
185 mm, 7 1/4"	<b>FF583R</b>	<b>FF584R</b>

 CUSHING

**FF803R**

2 x 10 mm

 LOVE-GRUENWALD

**FF805R**

3 x 10 mm

 1/1 SPURLING

**FF807R**

4 x 10 mm

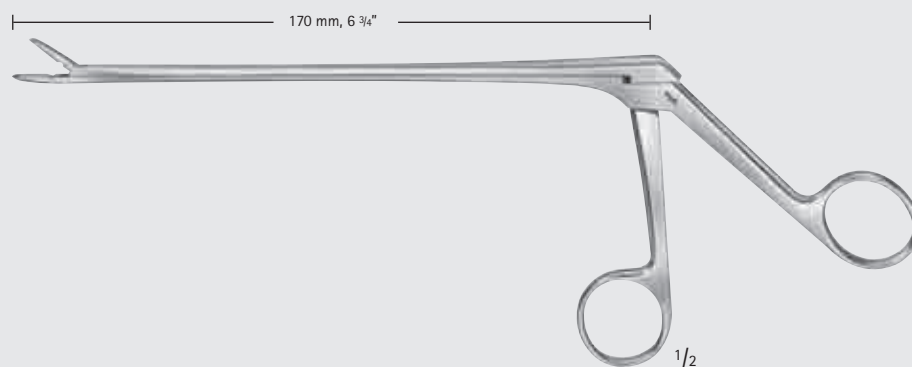

**FF803R-FF807R**



# Knochenstanzen, Rongeurs – Bone Punches, Rongeurs

Rongeurs  
Rongeurs

FF

150°

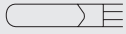

**FF806R**

3 x 10 mm



**FF814R**

4 x 10 mm

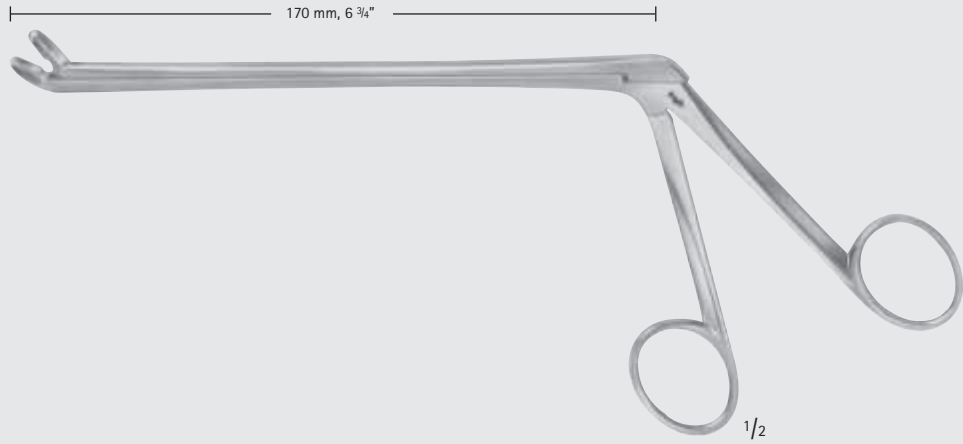

LOVE-GRUENWALD

**FF806R-FF814R**

150° oberes Maulteil beweglich  
upper part of jaw movable

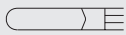

**FF810R**

3 x 10 mm

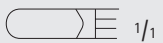

**FF811R**

4 x 10 mm

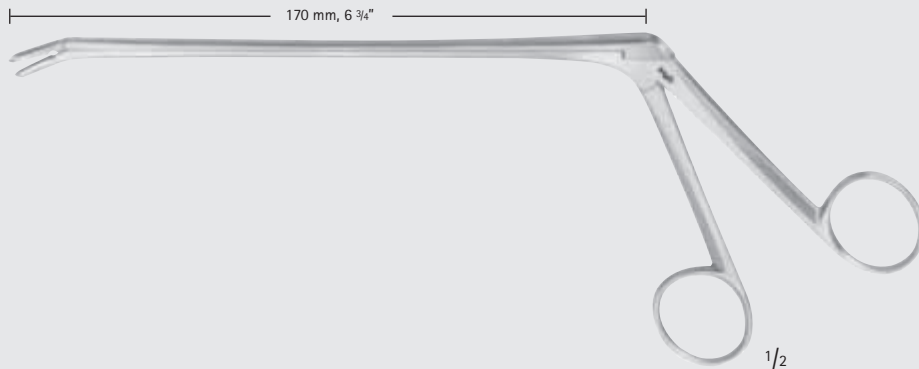

LOVE-GRUENWALD

**FF810R-FF811R**



MILLIMETERS

# Knochenstanzen, Rongeurs – Bone Punches, Rongeurs

Rongeurs

Rongeurs

FF



170 mm, 6 3/4"

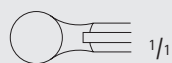

Ø 7,0 mm  
diam. 7.0 mm



OLDBERG

**FF605R**

185 mm, 7 1/4"



**FF599R**

Ø 2,2 mm  
diam. 2.2 mm

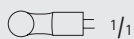

**FF600R**

Ø 3,5 mm  
diam. 3.5 mm

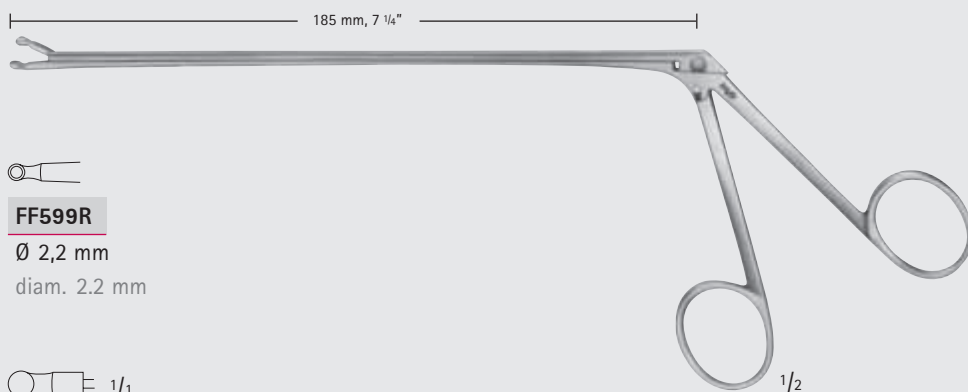

YASARGIL

**FF599R-FF600R**





## Knochenstanzen, Rongeurs – Bone Punches, Rongeurs

Rongeurs  
Rongeurs

FF

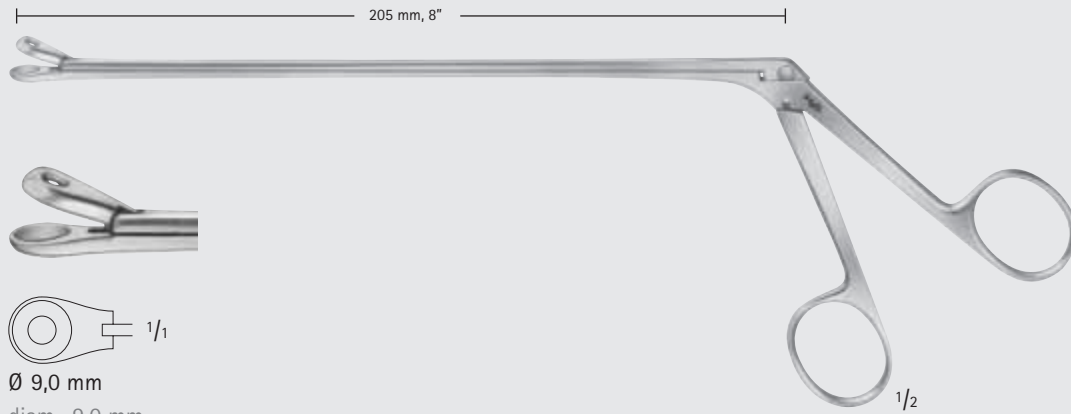

Ø 9,0 mm  
diam. 9.0 mm

LANDOLT

**FF345R**

Tumorfasszange, stumpf  
Tumor grasping forceps, blunt

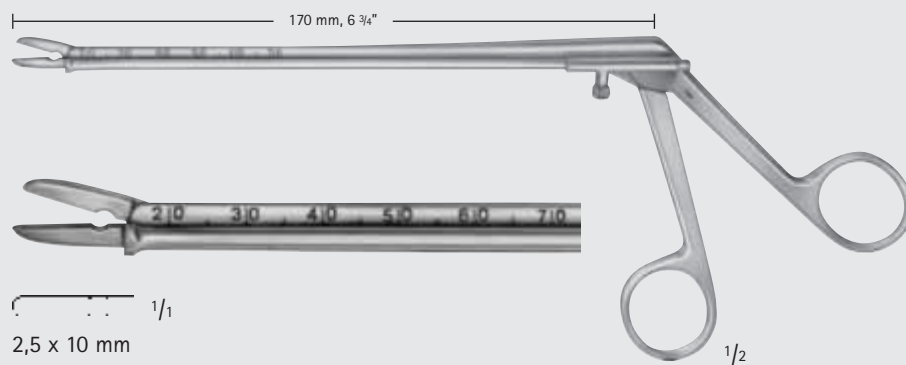

2,5 x 10 mm

KRÄMER

**FF820R**

mit Tiefenanschlag  
with depth guard



MILLIMETERS

# Knochenstanzen, Rongeurs – Bone Punches, Rongeurs

Rongeurs

Rongeurs

FF

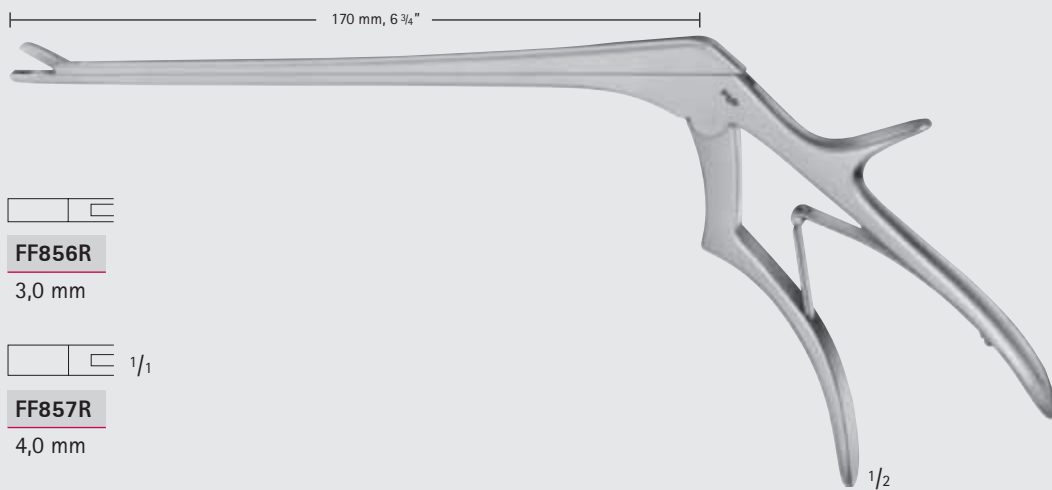

CASPAR

**FF856R-FF857R**

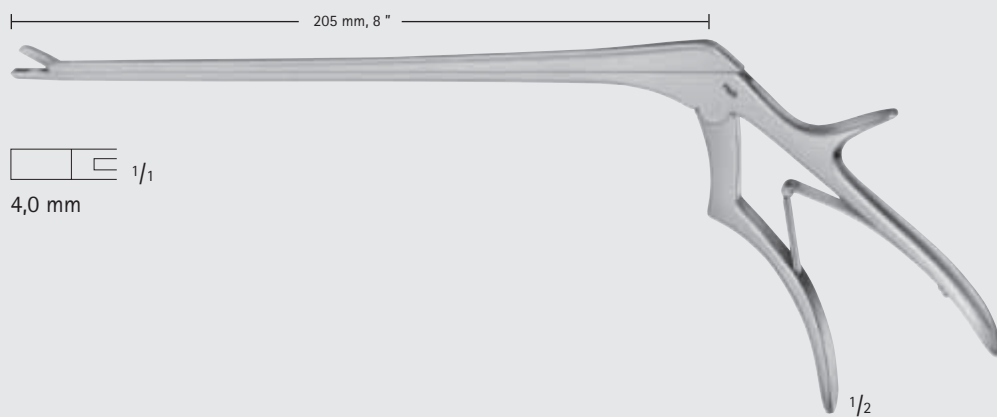

CASPAR

**FF858R**





# Knochenstanzen, Rongeurs – Bone Punches, Rongeurs

Rongeurs  
Rongeurs

FF

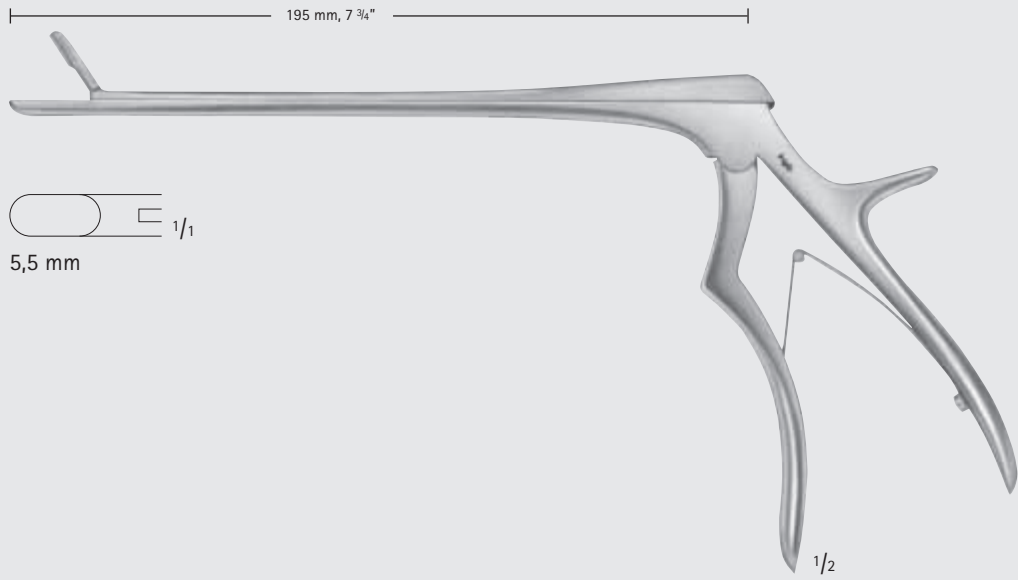

WAGNER

FF818R

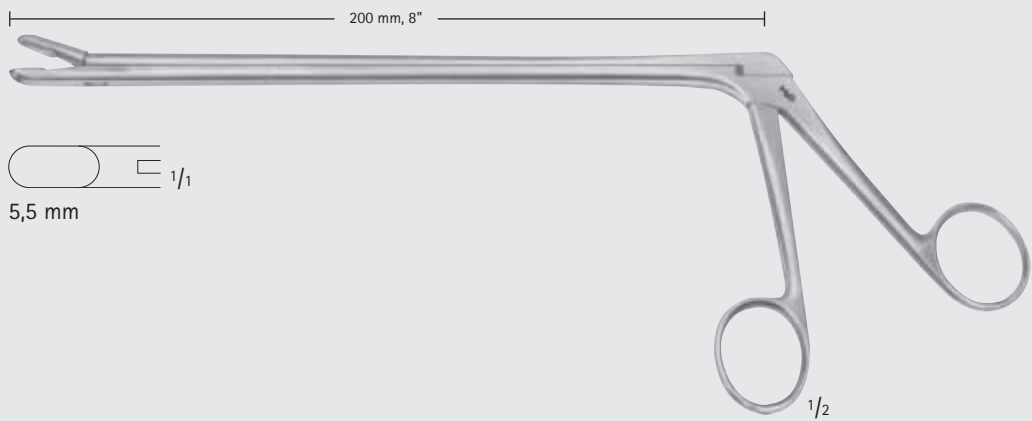

WAGNER

FF808R



MILLIMETERS

# Knochenstanzen, Rongeurs – Bone Punches, Rongeurs

Rongeurs

Rongeurs

FF

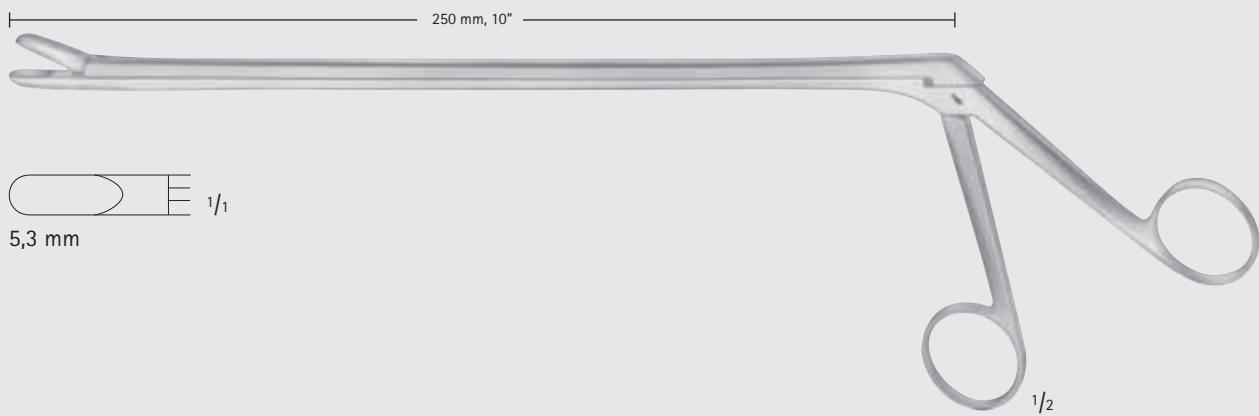

ND087R

150°

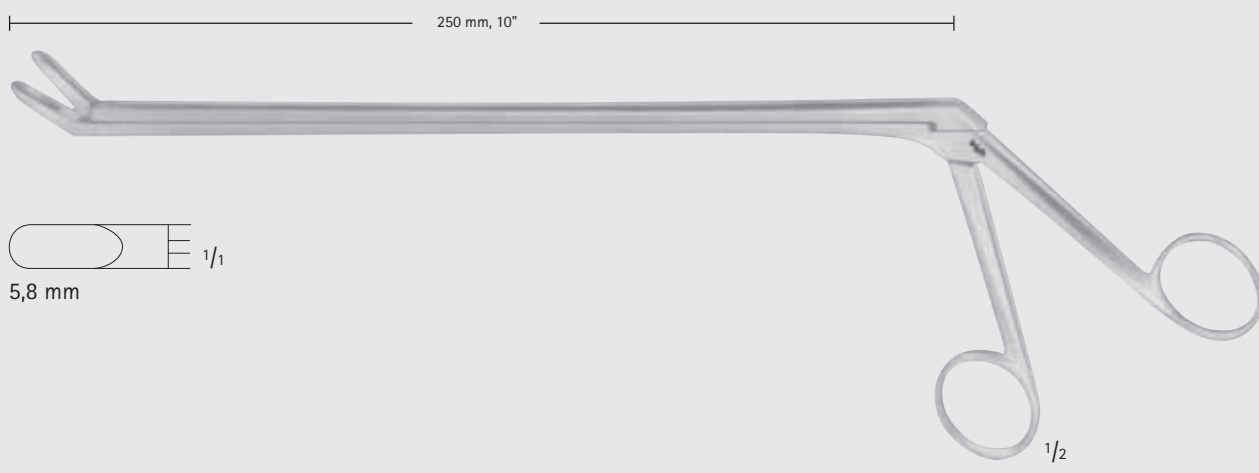

SYPERT  
FG057R



# Knochenstanzen, Rongeurs – Bone Punches, Rongeurs

## Ligamentum Flavum Faszange

### Grasping Forceps for Ligamentum Flavum

FF

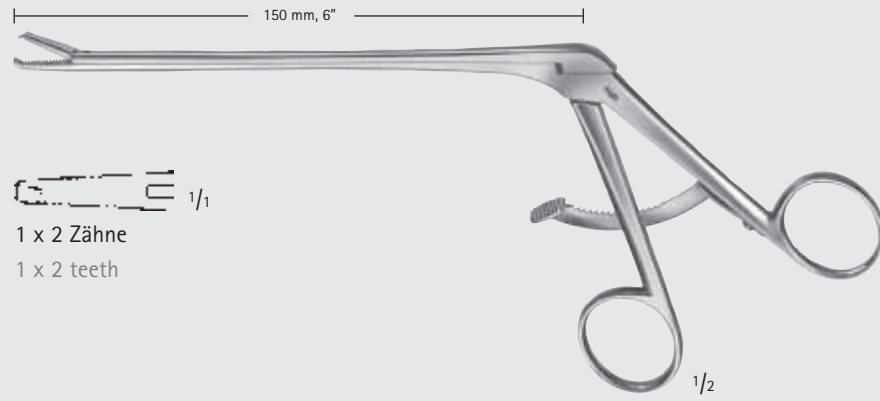

1/1  
1 x 2 Zähne  
1 x 2 teeth

KRÄMER

**FO820R**

mit Sperre  
with catch



MILLIMETERS

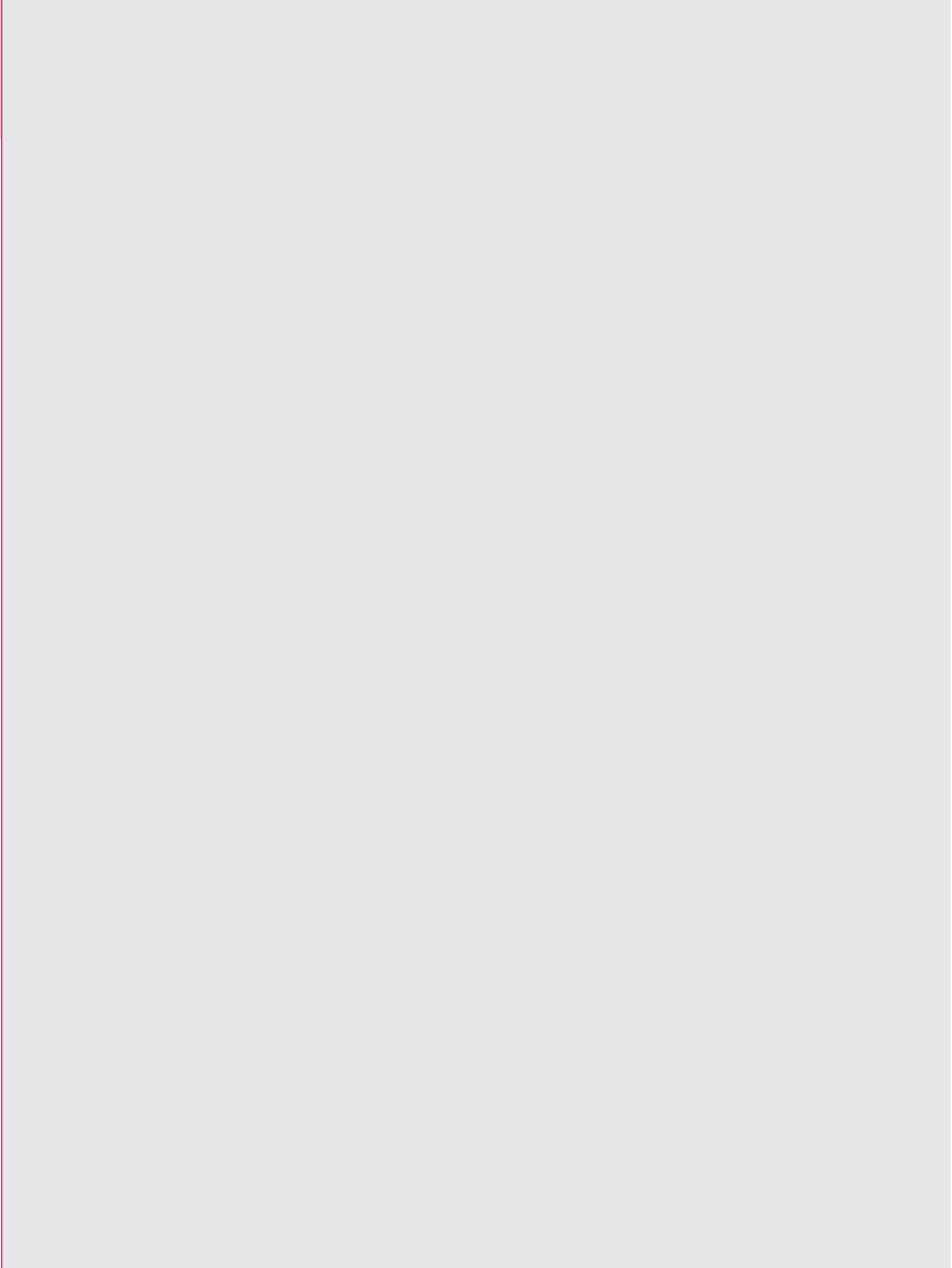



FH



**Amputation**  
Amputation

## Amputation – Amputation

Amputation

Amputation

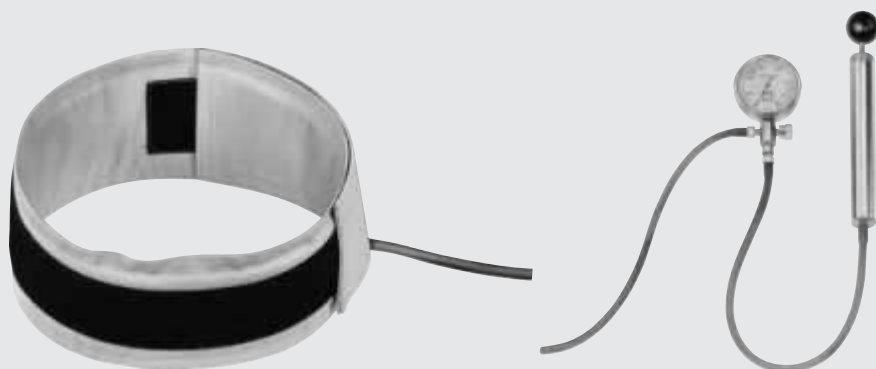

### FH001

Komprimierer zur Erzeugung einer Blutleere in den Extremitäten. Manometer mit Messbereich bis 600 mm Hg.

Komplett, bestehend aus:

FH002 Luftpumpe mit Manometer

FH003 Oberschenkel-Manschette, 13,5 cm x 120 cm

FH014 Oberarm-Manschette, 10 cm x 84 cm

Compression apparatus for producing exsanguination in the extremities.

Manometer registers up to 600 mm Hg.

Complete, consisting of:

FH002 Pump with manometer

FH003 Cuff for the leg, 13,5 cm x 120 cm

FH014 Cuff for the upper arm, 10 cm x 84 cm



**FH003** Oberschenkel-Manschette, 13,5 cm x 120 cm

Cuff for the leg, 13,5 cm x 120 cm

**\*FH004** Unterarm-Manschette, 9,5 x 50 cm

Cuff for the lower arm, 9,5 x 50 cm

**\*FH005** Kinder-Manschette, 7,3 x 36 cm

Cuff for children, 7,3 x 36 cm

**FH014** Oberarm-Manschette, 10 cm x 84 cm

Cuff for the upper arm, 10 cm x 84 cm

\* zusätzlich zu bestellen zu FH001

\* to be ordered separately for FH001



ESMARCH

### FH010

Staubbinde

5 m lang

6 cm breit

Compression bandage

5 m long

6 cm wide





**Amputation – Amputation**  
 Amputationsmesser  
 Amputation Knives

**FH**



doppelschneidig  
 double cutting

**LISTON**

**FH100R-FH103R**

Amputationsmesser  
 Amputation knives

	<b>FH100R</b>	<b>FH101R</b>	<b>FH102R</b>	<b>FH103R</b>
Schnittlänge:	130 mm	160 mm	190 mm	220 mm
Blade length:	5 1/8"	6 1/4"	7 1/2"	8 3/4"

Schnittlänge: 130 mm 160 mm 190 mm 220 mm  
 Blade length: 5 1/8" 6 1/4" 7 1/2" 8 3/4"



doppelschneidig  
 double cutting

**CATLIN**

**FH116R**

Amputationsmesser  
 Amputation knife

Schnittlänge: 160 mm  
 Blade length: 6 1/4"



**LANGENBECK**

**FH150R**

Lappenmesser  
 Flap knife

Schnittlänge: 120 mm  
 Blade length: 6 1/4"

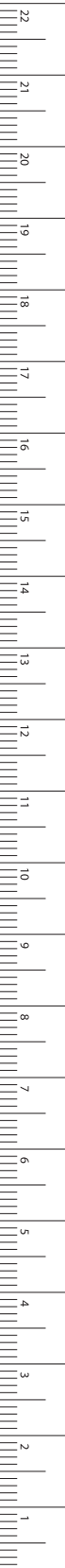

MILLIMETERS

**Amputation – Amputation**  
 Amputations- und Resektionsmesser  
 Amputation- and Resection Knives

**FH**



1/2

**FH160R**

Phalangenmesser  
 Phalangeal knife

Schnittlänge: 105 mm  
 Blade length: 4 1/8"



1/2

**FH166R**

Zwischenknochenmesser  
 Interosseous knife

Schnittlänge: 110 mm  
 Blade length: 4 3/8"

doppelschneidig  
 double cutting



1/2

**FH170R**

Beinhautmesser  
 mit Schaber  
 Periosteum knife  
 with raspatory

Schnittlänge: 65 mm  
 Blade length: 2 1/2"



**FH191R**

**FH192R**

1/1

**LANGENBECK**

**FH191R-FH192R**

Resektionsmesser  
 Resection knives

Schnittlänge: 55 mm  
 Blade length: 2 1/8"



## Amputation – Amputation

Sterilisierahmen für Resektions- und Amputationsmesser  
Sterilizing Racks for Resection- and Amputation Knives

FH

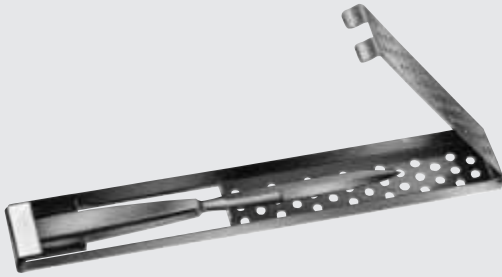

### FH194R

Sterilisierahmen für 1 Messer  
mit Schnittlänge bis 140 mm  
Sterilizing rack for 1 knife  
with length of blade up to 140 mm  
290 x 40 x 14 mm

### FH194R-FH197R

für Resektions- und Amputationsmesser  
for Resection- and Amputation knives



### FH197R

Sterilisierahmen für 2 Messer  
mit Schnittlängen bis 190 mm  
Sterilizing rack for 2 knives  
with length of blade up to 190 mm  
335 x 65 x 14 mm

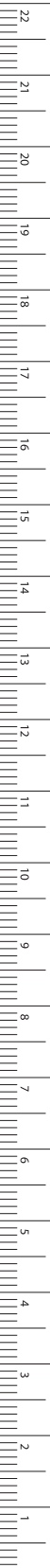

MILLIMETERS

## Amputation – Amputation

Amputationsretractoren

Amputation Retractors

FH

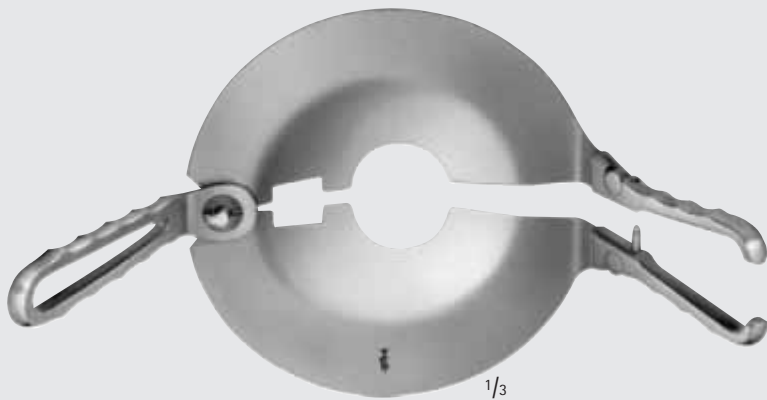

PERCY

**FH220R**

Griffe abnehmbar  
removable handles

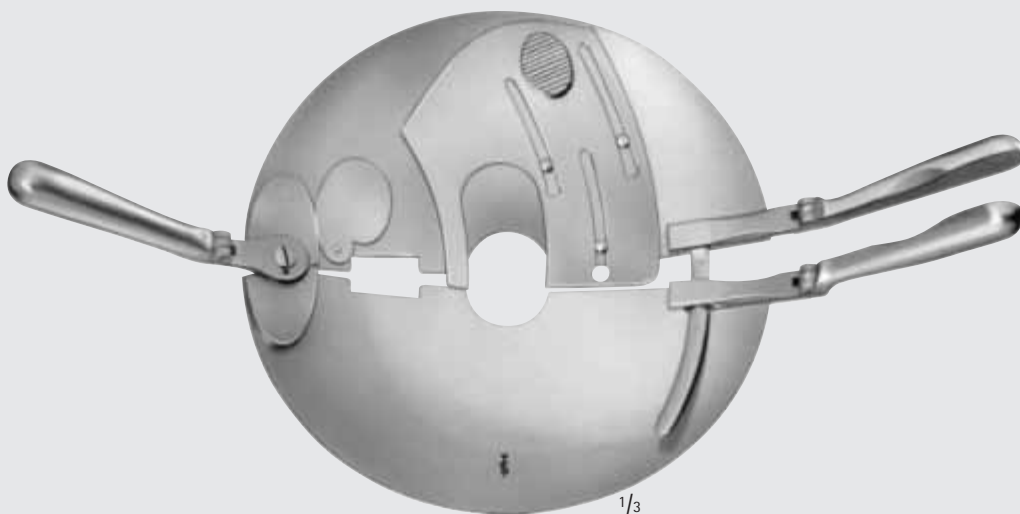

PERCY

**FH222R**

Griffe umlegbar  
reversible handles



## Amputation – Amputation Amputationssägen Amputation Saws

FH



1/3

### CHARRIÈRE

#### FH300R

komplett mit je 1 Sägeblatt  
complete with one saw blade each

FH301C 12 mm

FH302C 18 mm

350 mm, 14"

#### FH301C-FH302C

Ersatz-Sägeblätter, Normalstahl verchromt  
Spare saw blades, carbon steel chromium plated

	Breite Width	Blattlänge Blade length
<b>FH301C</b>	12 mm	215 mm, 8 1/2"
<b>FH302C</b>	18 mm	215 mm, 8 1/2"

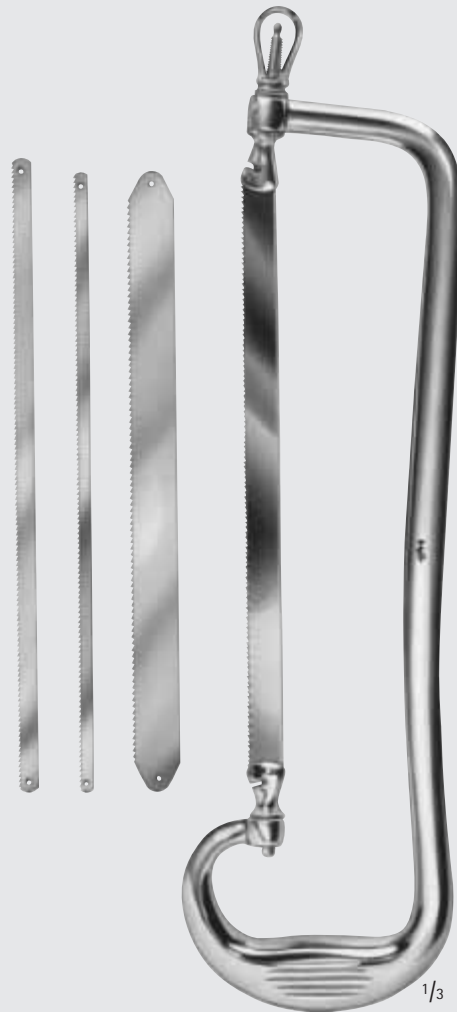

1/3

### RUST

#### FH305R

komplett mit Sägeblättern  
complete with saw blades

1 FH307C 6 mm

1 FH308C 8 mm

2 FH310C 12 mm

390 mm, 15 1/2"

#### FH306R

Bogen allein  
Bow only

#### FH307C-FH312C

Ersatz-Sägeblätter, Normalstahl verchromt  
Spare saw blades, carbon steel chromium plated

	Breite Width	Blattlänge Blade length
<b>FH307C</b>	6 mm	235 mm, 9 1/4"
<b>FH308C</b>	8 mm	235 mm, 9 1/4"
<b>FH310C</b>	12 mm	235 mm, 9 1/4"
<b>FH312C</b>	18 mm	235 mm, 9 1/4"

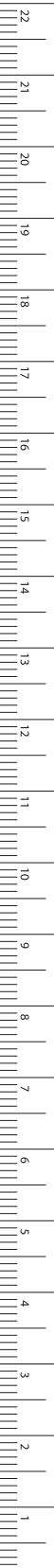

MILLIMETERS

## Amputation – Amputation

Amputationssägen

Amputation Saws

FH

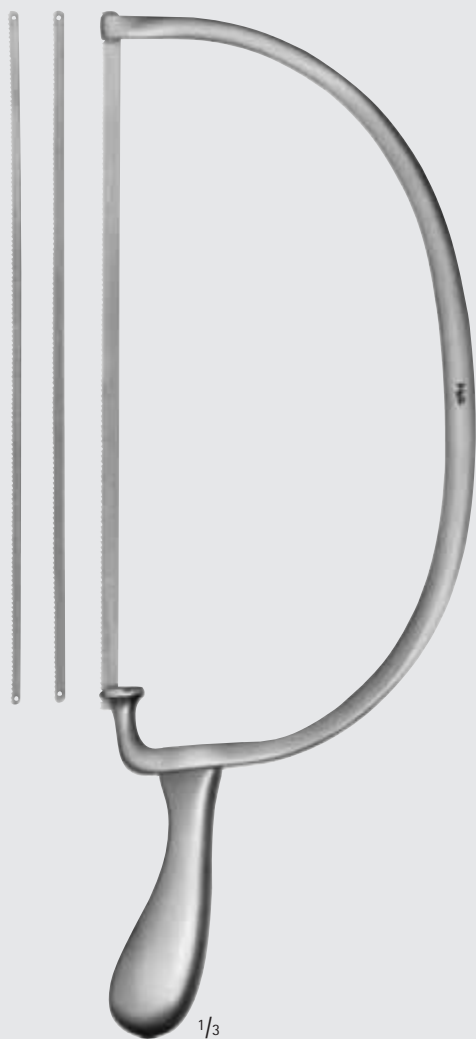

1/3

BIER

**FH313R**

komplett mit je 1 Sägeblatt

complete with one saw blade each

FH314C 4 mm

FH315C 6 mm

FH316C 8 mm

420 mm, 16 3/4"

**FH314C-FH316C**

Ersatz-Sägeblätter, Normalstahl verchromt

Spare saw blades, carbon steel chromium plated

	Breite Width	Blattlänge Blade length
<b>FH314C</b>	4 mm	270 mm, 10 1/2"
<b>FH315C</b>	6 mm	270 mm, 10 1/2"
<b>FH316C</b>	8 mm	270 mm, 10 1/2"



1/2

CHARRIÈRE

**FH320R**

270 mm, 10 1/2"

Blattlänge: 184 mm,

Blade length: 7 1/4"



## Amputation – Amputation Amputationssägen Amputation Saws

FH



SATTERLEE

**FH325R**

290 mm, 11 1/2"

Blattlänge

Blade length

**FH326R** 200 mm, 8"

Ersatz-Sägeblatt

Spare saw blade



LANGENBECK

**FH335R**

Finger-Stichsäge

Metacarpal saw

235 mm, 9 1/4"

Blattlänge: 115 mm,

Blade length: 4 1/2"

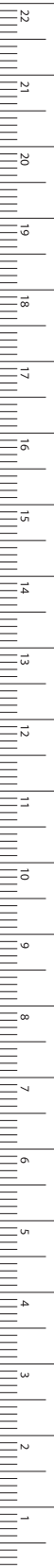

MILLIMETERS

## Amputation – Amputation

Drahtsägen

Wire Saws

FH

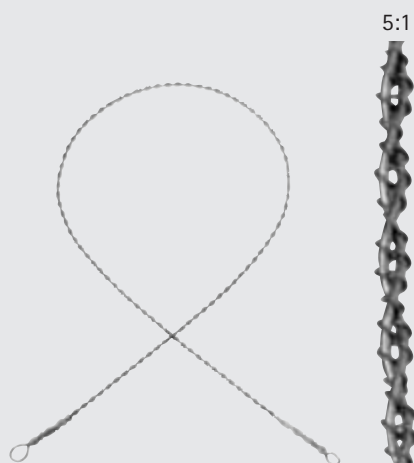

OLIVECRONA

Ø  
Diam.

<b>FH403</b>	1,5 mm	300 mm, 12"
<b>FH404</b>	1,3 mm	400 mm, 16"
<b>FH405</b>	1,2 mm	500 mm, 20"
<b>FH407</b>	1,2 mm	700 mm, 28"

Bestelleinheit:

PAK = Packung à 5 Stück

Sales unit:

PAK = Package of 5 pieces

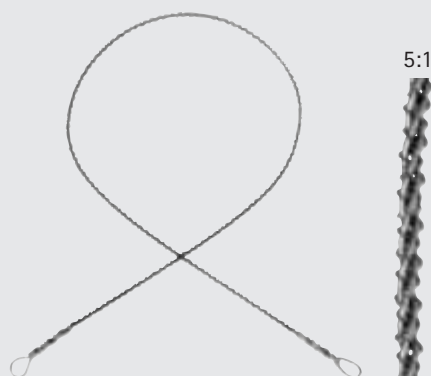

GIGLI

Ø  
Diam.

<b>FH413</b>	1,4 mm	300 mm, 12"
<b>FH414</b>	1,4 mm	400 mm, 16"
<b>FH415</b>	1,4 mm	500 mm, 20"

fein, 6-teilig

fine, 6 wires twisted

**FH430R**

grob, 4-teilig

coarse, 4 wires twisted

500 mm, 20"

Bestelleinheit:

PAK = Packung à 5 Stück

Sales unit:

PAK = Package of 5 pieces



GIGLI

**FH480R**

Griff

Handle





1/2

LEBSCHÉ

**FF133C**

Umführungsinstrument für GIGLI und OLIVECRONA Drahtsägen, biegsam  
 Conductor for GIGLI and OLIVECRONA wire saws, malleable  
 250 mm, 10"



1/2

DE MARTEL

**FF130R**

Umführungsinstrument für GIGLI und OLIVECRONA Drahtsägen, flexibel  
 Conductor for GIGLI and OLIVECRONA wire saws, flexible  
 350 mm, 14"

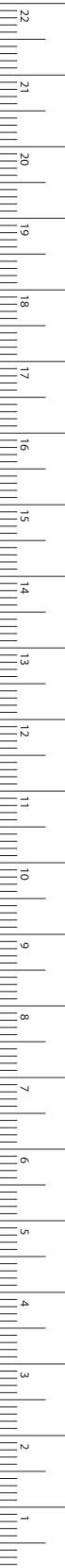

MILLIMETERS

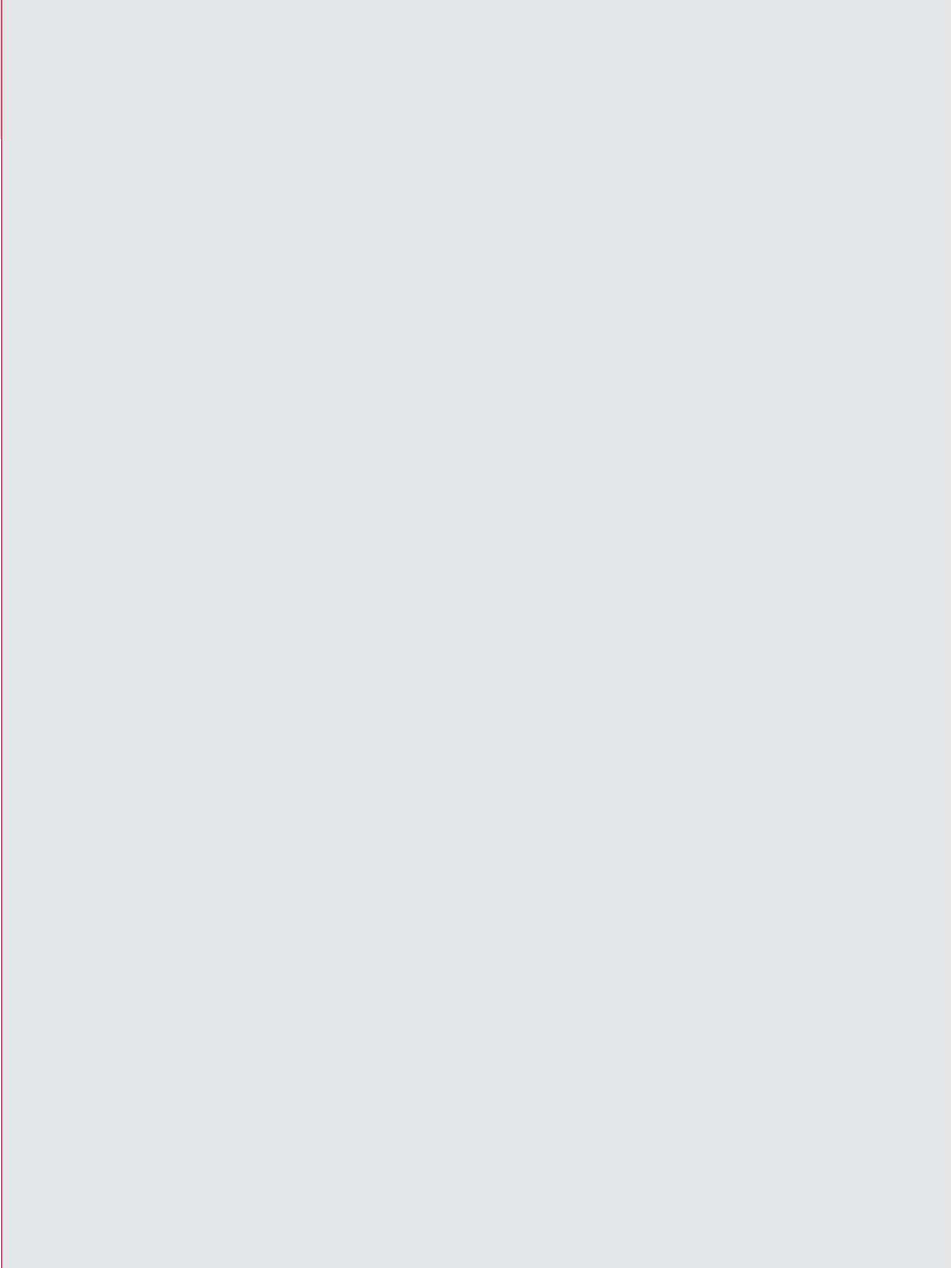

FK



**Knochenhebel, Elevatorien,  
Raspatorien, Scharfe Löffel**  
Bone Levers, Periosteal Elevators,  
Bone Curettes

# Knochenheber, Raspatorien, Scharfe Löffel – Bone Levers, Elevators, Bone Curettes

Dissektoren

Dissectors

FK

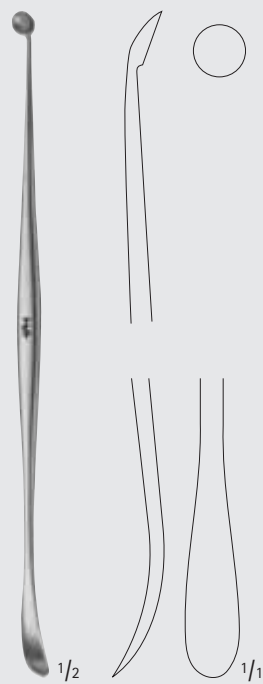

PENFIELD

**FF291R**

Fig. 1  
doppelendig  
double-ended  
175 mm, 7"

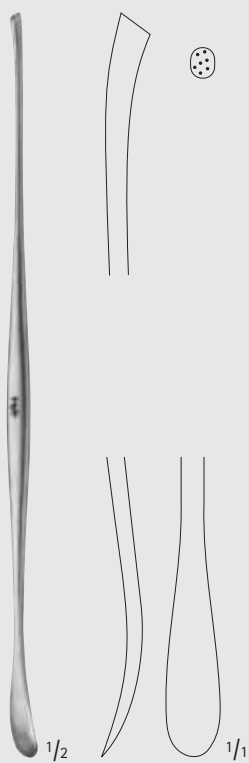

PENFIELD

**FF292R**

Fig. 2  
doppelendig  
double-ended  
195 mm, 7 3/4"

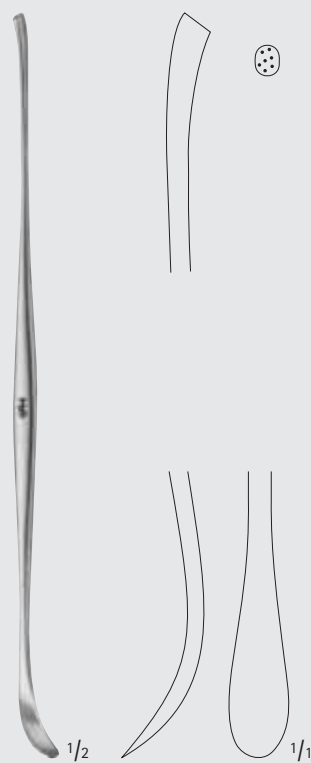

PENFIELD

**FF293R**

Fig. 3  
doppelendig  
double-ended  
195 mm, 7 3/4"



PENFIELD

**FF294R**

Fig. 4  
leicht gebogen  
slightly curved  
205 mm, 8"

# Knochenheber, Raspatorien, Scharfe Löffel – Bone Levers, Elevators, Bone Curettes

Dissektoren, Hohlsonden  
Dissector, Grooved Director

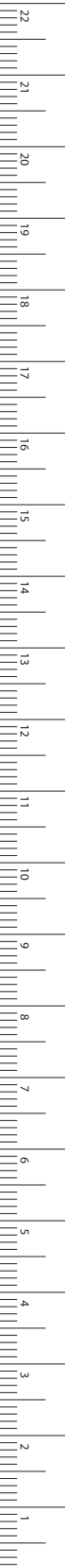
**SWEDISH**
**FF347R** 180 mm, 7"

 leichtes Modell  
light pattern

**FF348R** 200 mm, 8"

 kräftiges Modell  
heavy pattern

**PENNYBACKER**
**FF349R**

 Sonde und Dissektor  
Probe dissector  
230 mm, 9"

**O'CONNELL**
**FF730R**

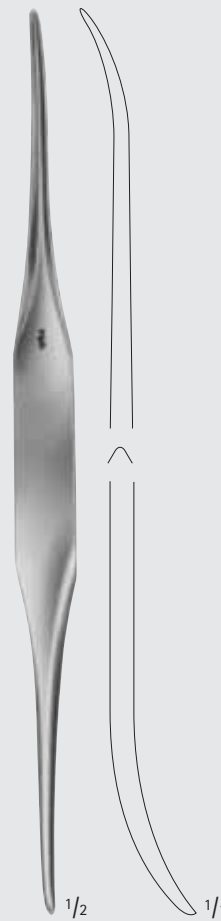
 doppelendig  
double-ended  
220 mm, 8 3/4"

**TÖNNIS**
**FF308R**

 Hohlsonde  
Grooved director  
240 mm, 9 1/2"

**PENFIELD**
**FF295R**

 Fig. 5  
doppelendig, leicht gebogen  
double-ended, slightly curved  
290 mm, 11 1/2"

# Knochenhebel, Raspatorien, Scharfe Löffel – Bone Levers, Elevators, Bone Curettes

Elevatoren und Knochenhebel

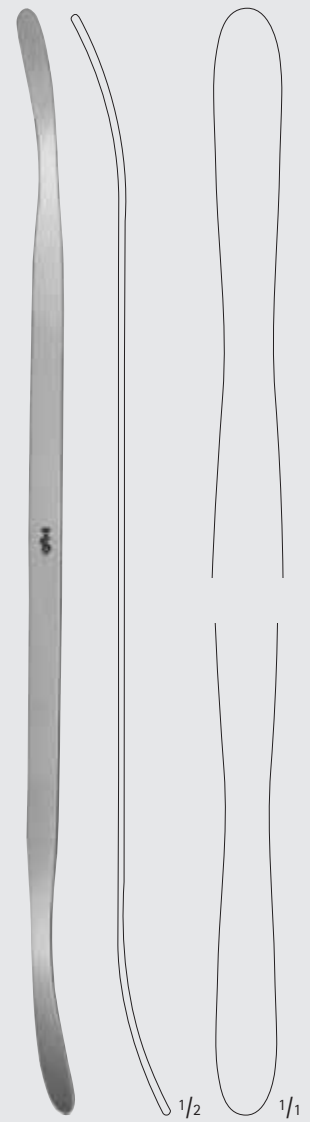
Elevators and Bone Levers

FK

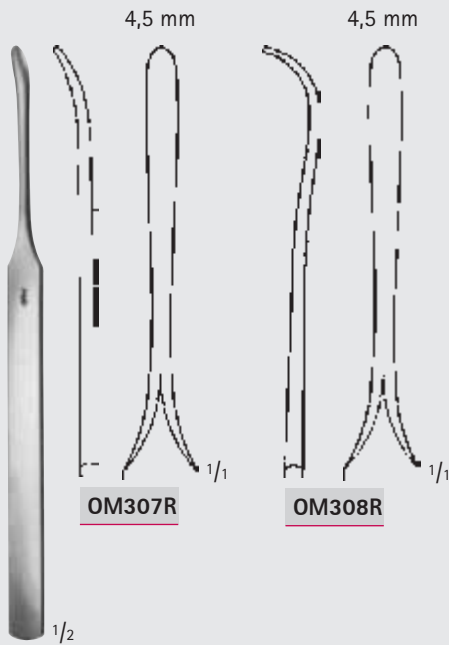

OM307R

OM308R

KÖNIG

OM307R-OM308R

155 mm, 6"

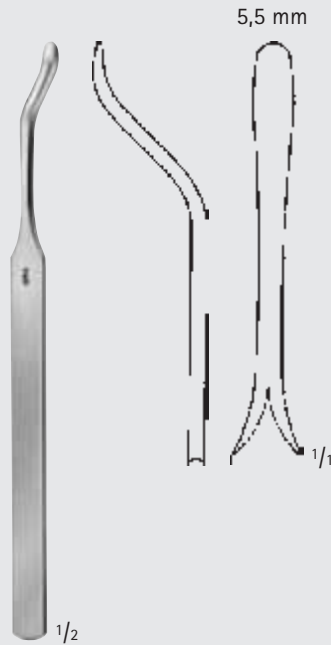

FK110R

155 mm, 6"



CAIRNS

FK141R

175 mm, 6 3/4"

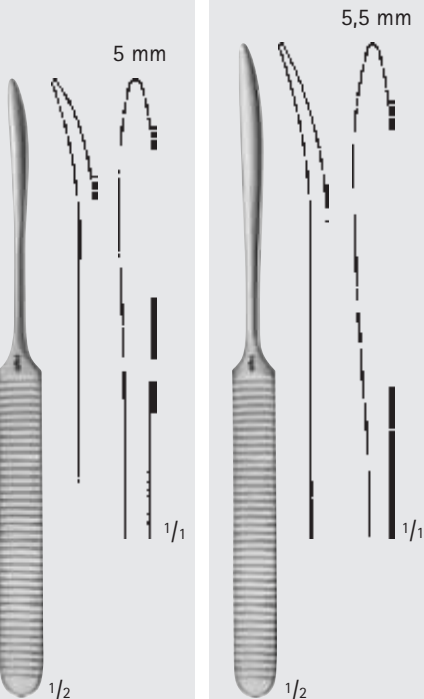

WILLIGER

FK120R

165 mm, 6 1/2"

WILLIGER

FK121R

170 mm, 6 3/4"



CHANDLER

MB275R-MB278R

MB275R

klein

small

14 mm

185 mm

7 1/4"

MB276R

mittel

medium

19 mm

205 mm

8"

MB277R

groß

large

25 mm

235 mm

9 1/4"

MB278R

extra groß

extra large

30 mm

255 mm

10"



# Knochenheber, Raspatorien, Scharfe Löffel – Bone Levers, Elevators, Bone Curettes

Elevatorien und Knochenheber

Elevators and Bone Levers

FK

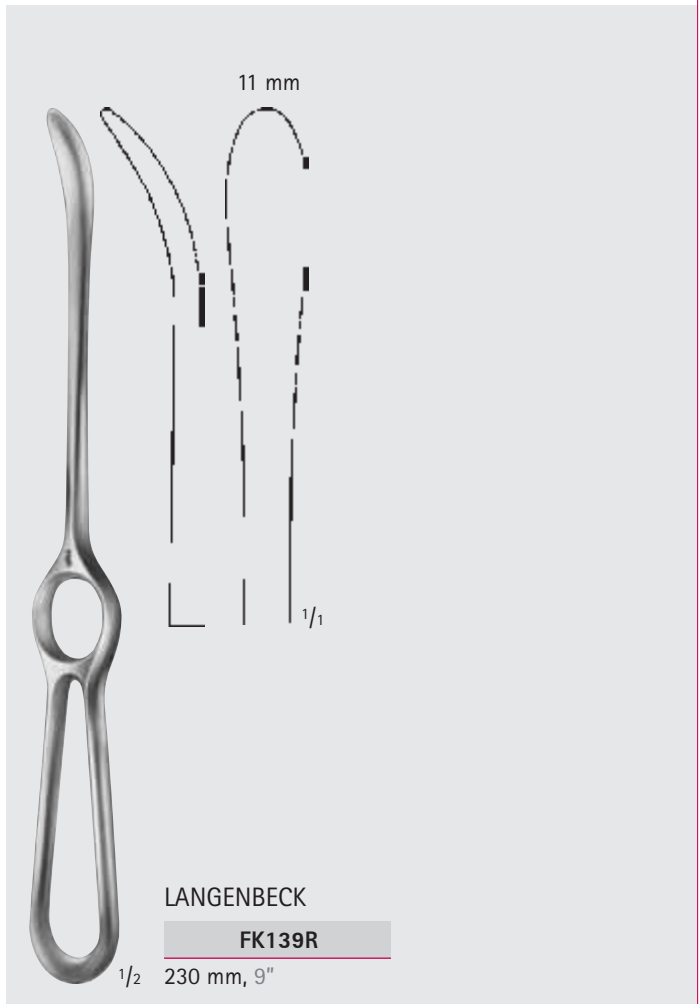
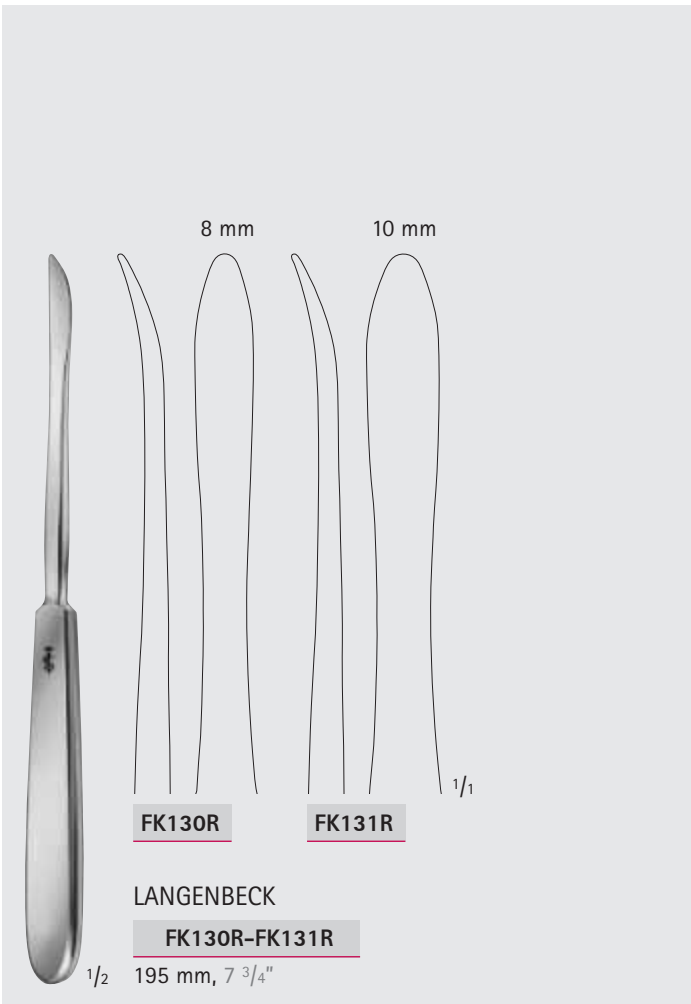
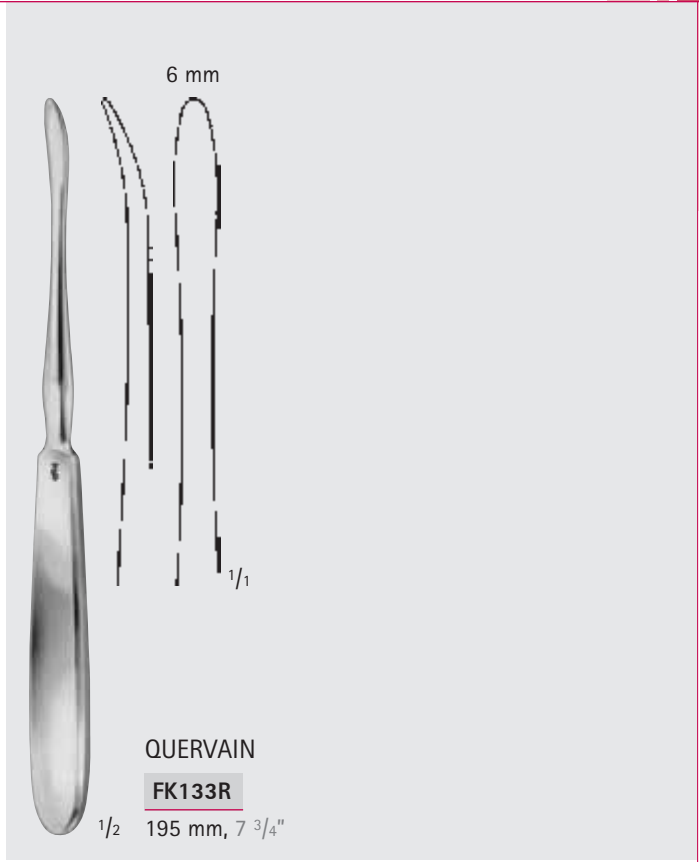
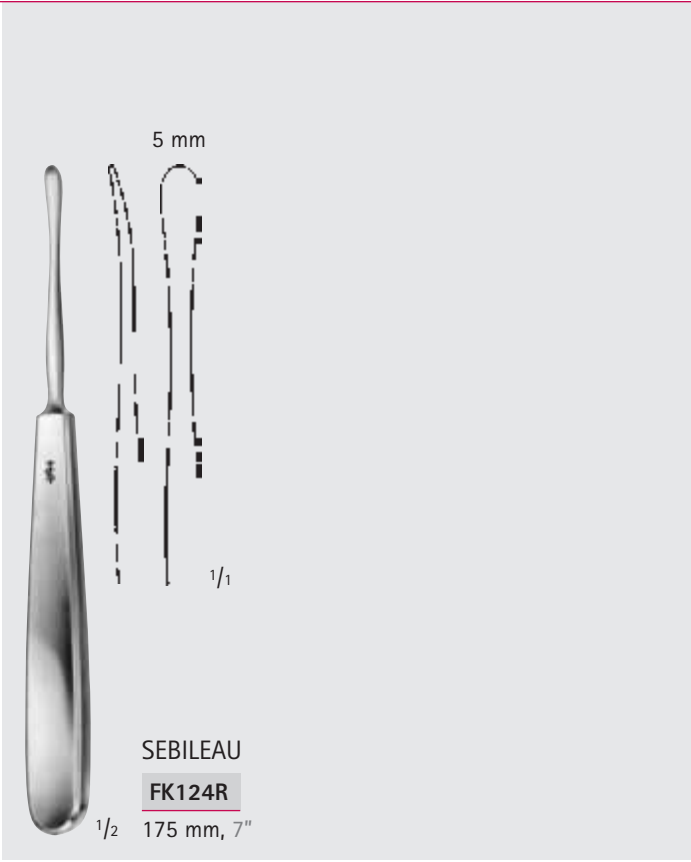

MILLIMETERS

# Knochenheber, Raspatorien, Scharfe Löffel – Bone Levers, Elevators, Bone Curettes

## Knochenheber

### Bone Levers

FK

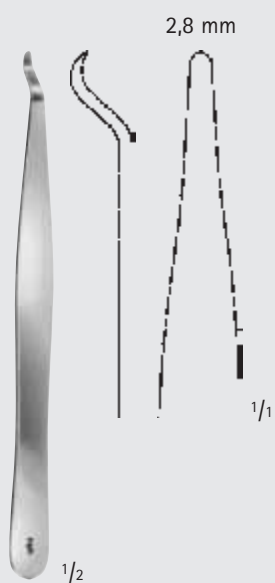

**FK111R**

140 mm, 5 1/2"

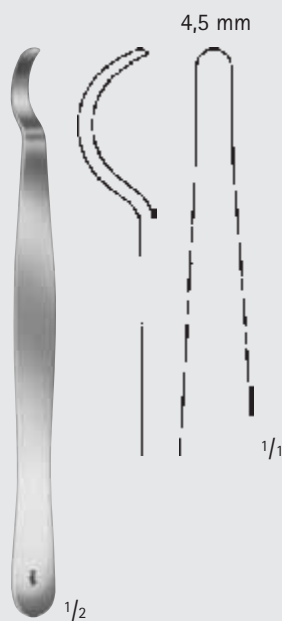

**FK113R**

150 mm, 6"

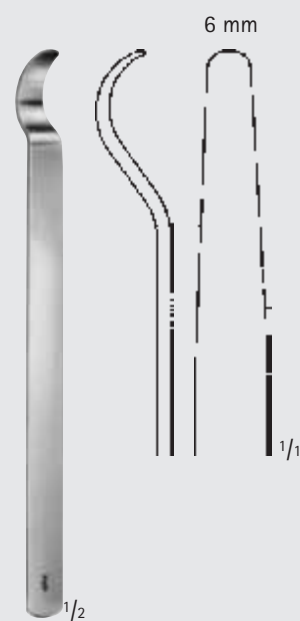

**FK114R**

150 mm, 6"

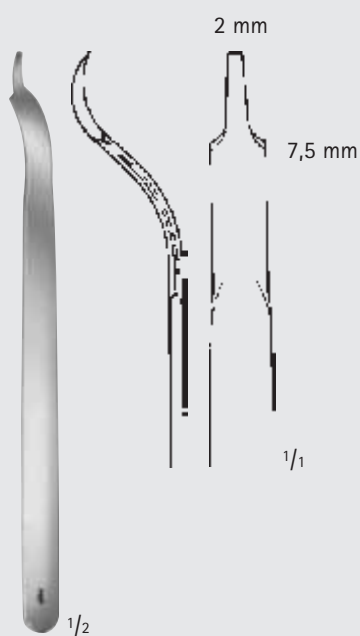

**BUCK-GRAMCKO**

**FK116R**

150 mm, 6"



**FK117R**

160 mm, 6 1/4"

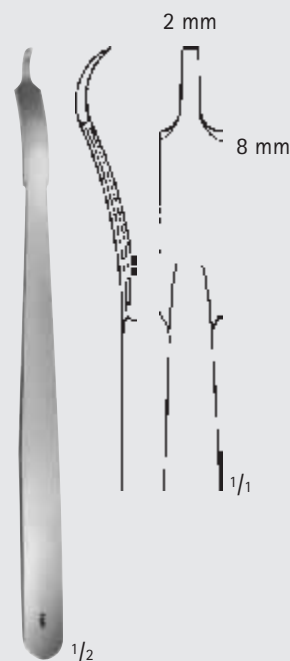

**FK118R**

160 mm, 6 1/4"

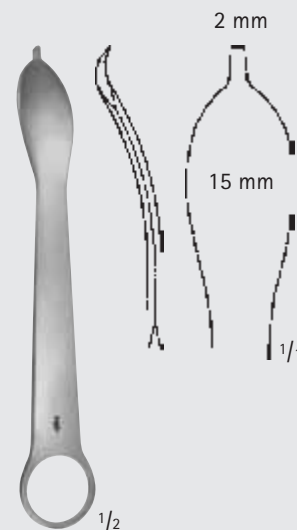

**FK119R**

125 mm, 5"





# Knochenheber, Raspatorien, Scharfe Löffel – Bone Levers, Elevators, Bone Curettes

Knochenheber  
Bone Levers

FK



LANE TRETOWAN

FK135R

215 mm, 8 1/2"

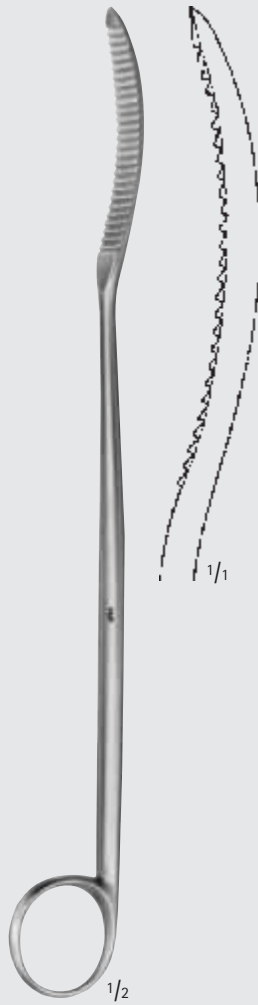

LANE

FK136R

255 mm, 10"

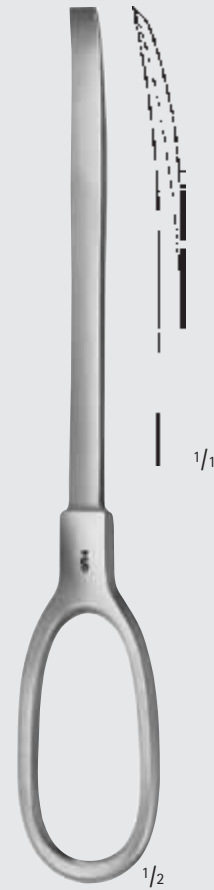

BRISTOW

FK140R

230 mm, 9"



MILLIMETERS

# Knochenheber, Raspatorien, Scharfe Löffel – Bone Levers, Elevators, Bone Curettes

Knochenheber

Bone Levers

FK



WATSON-JONES

**FK156R**

280 mm, 11"

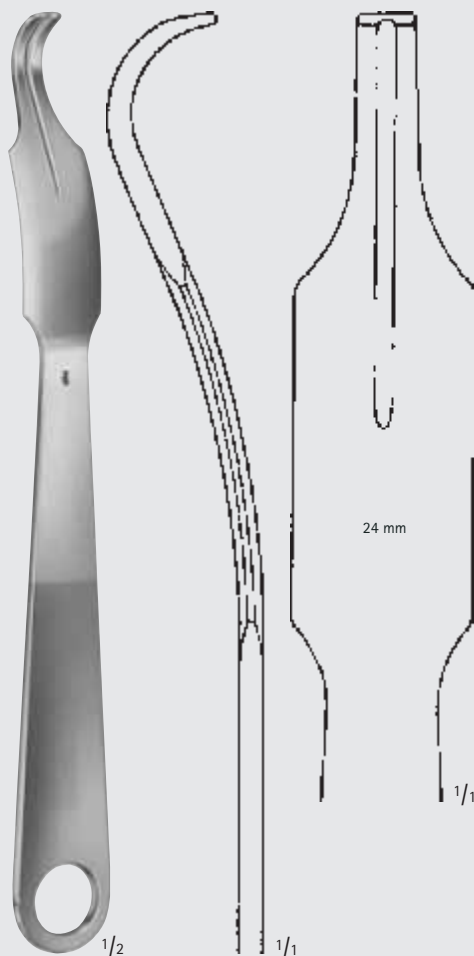

LANGE-HOHMANN

**FK160R**

250 mm, 10"



# Knochenheber, Raspatorien, Scharfe Löffel – Bone Levers, Elevators, Bone Curettes

Knochenheber  
Bone Levers

FK

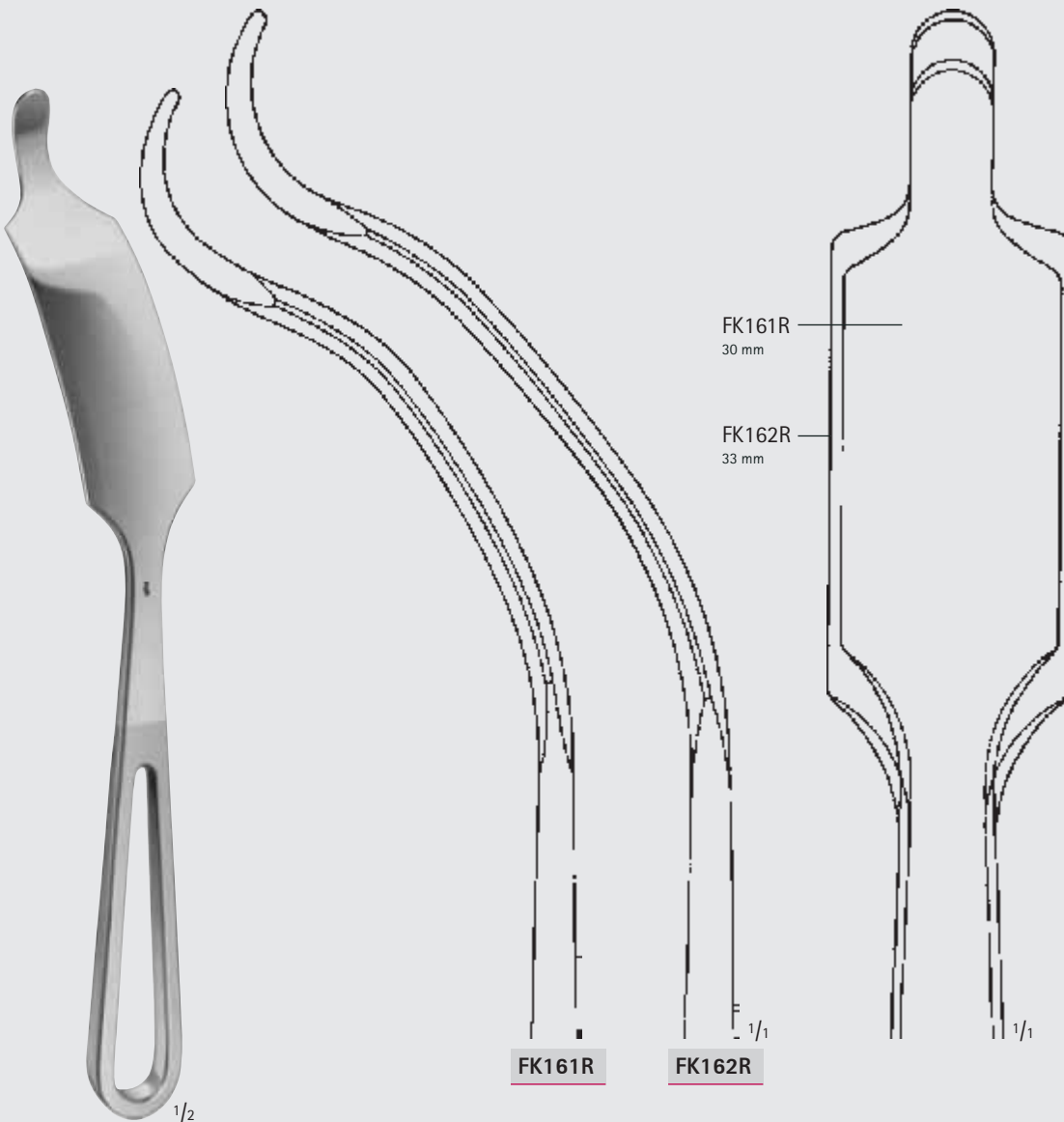

LANGE-HOHMANN MODIF.

<b>FK161R</b>	265 mm	10 1/2"
<b>FK162R</b>	280 mm	11 1/2"

MILLIMETERS

# Knochenheber, Raspatorien, Scharfe Löffel – Bone Levers, Elevators, Bone Curettes

Knochenheber

Bone Levers

FK

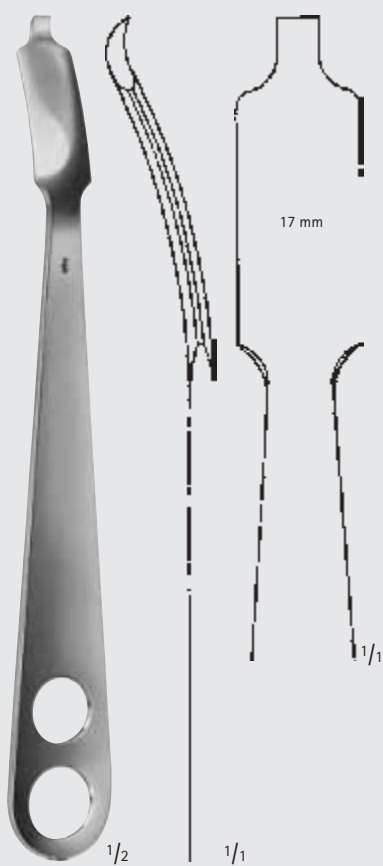

WAGNER

**FK167R**

220 mm, 8 3/4"

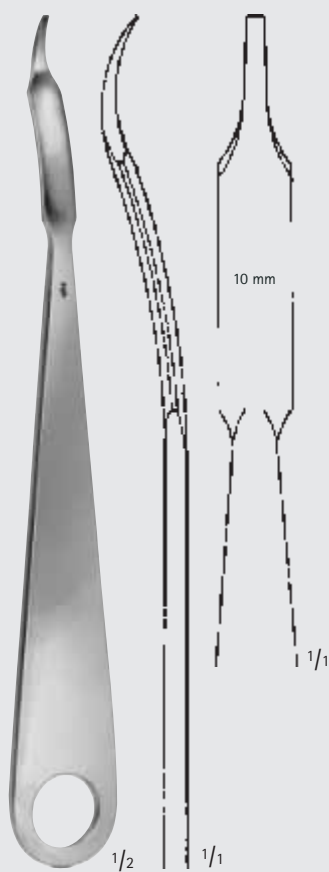

**FK170R**

220 mm, 8 3/4"

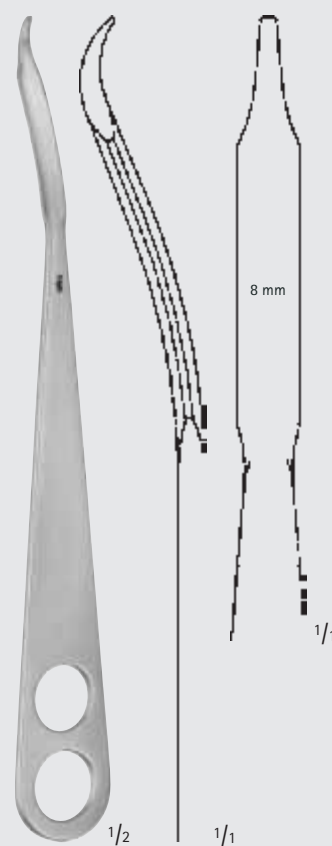

**FK185R**

220 mm, 8 3/4"



# Knochenheber, Raspatorien, Scharfe Löffel – Bone Levers, Elevators, Bone Curettes

Knochenheber  
Bone Levers

**FK**

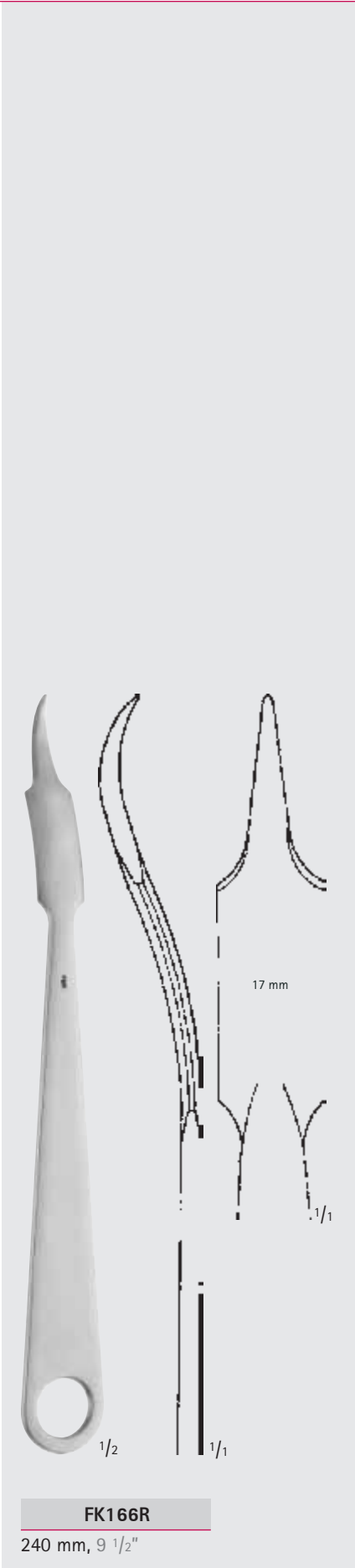

**FK166R**

240 mm, 9 1/2"

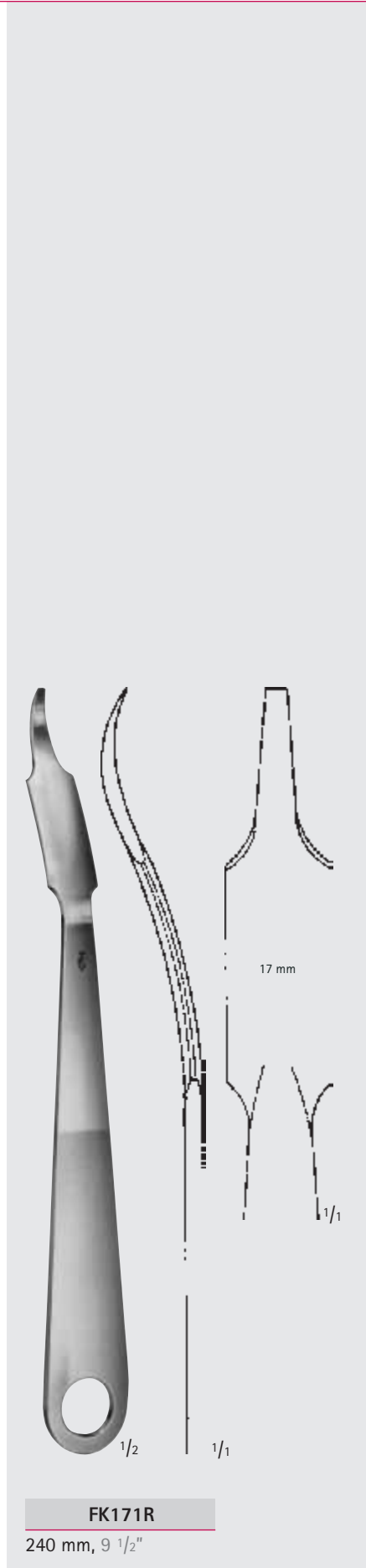

**FK171R**

240 mm, 9 1/2"

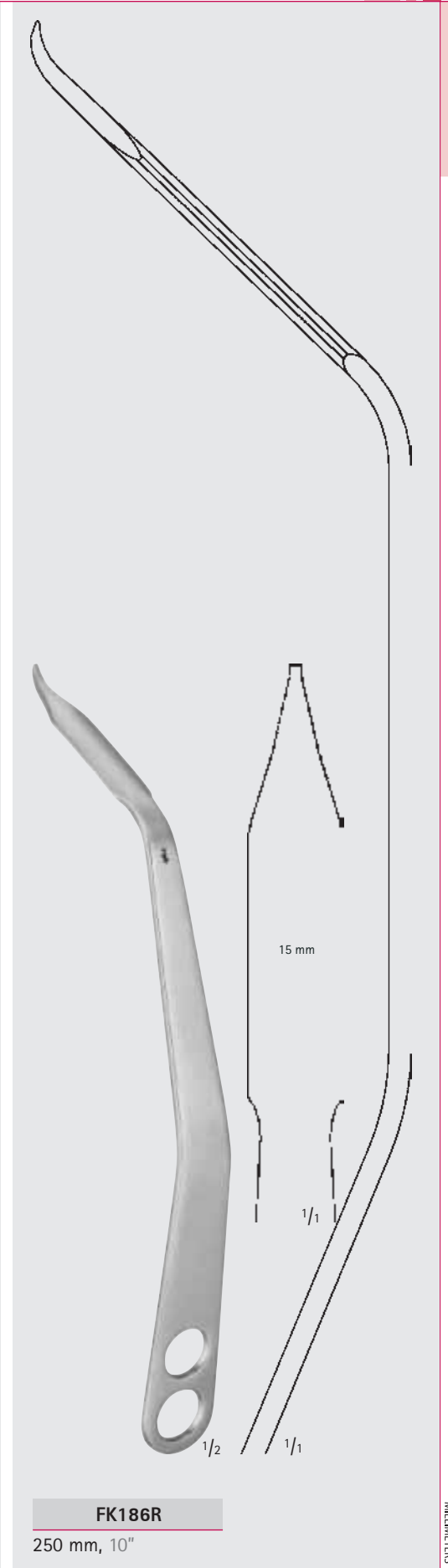

**FK186R**

250 mm, 10"



MILLIMETERS

# Knochenheber, Raspatorien, Scharfe Löffel – Bone Levers, Elevators, Bone Curettes

Knochenheber

Bone Levers

FK

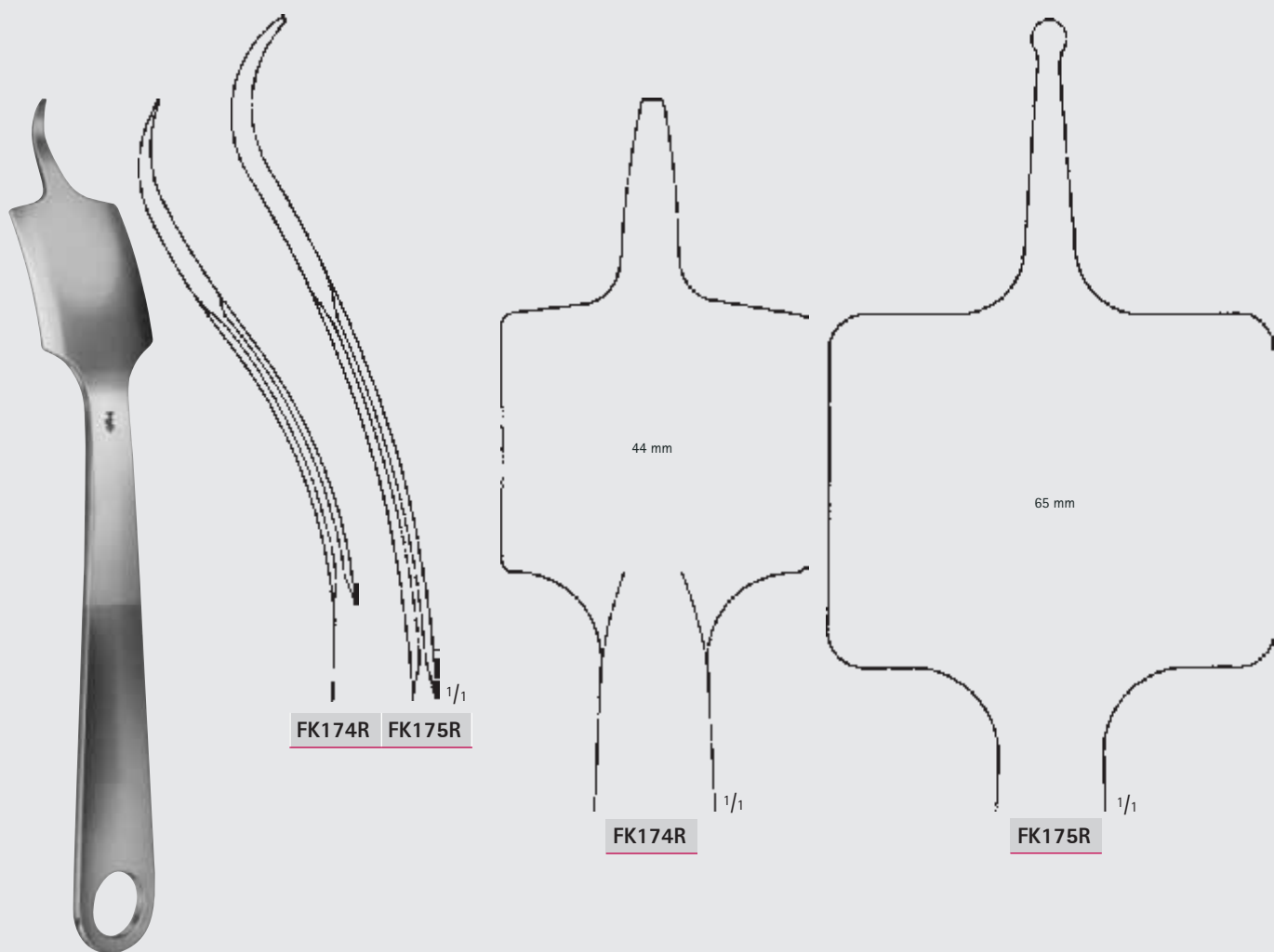

VERBRUGGE-MÜLLER

FK174R	240 mm	9 1/2"
FK175R	255 mm	10"



# Knochenheber, Raspatorien, Scharfe Löffel – Bone Levers, Elevators, Bone Curettes

Knochenheber  
Bone Levers

FK

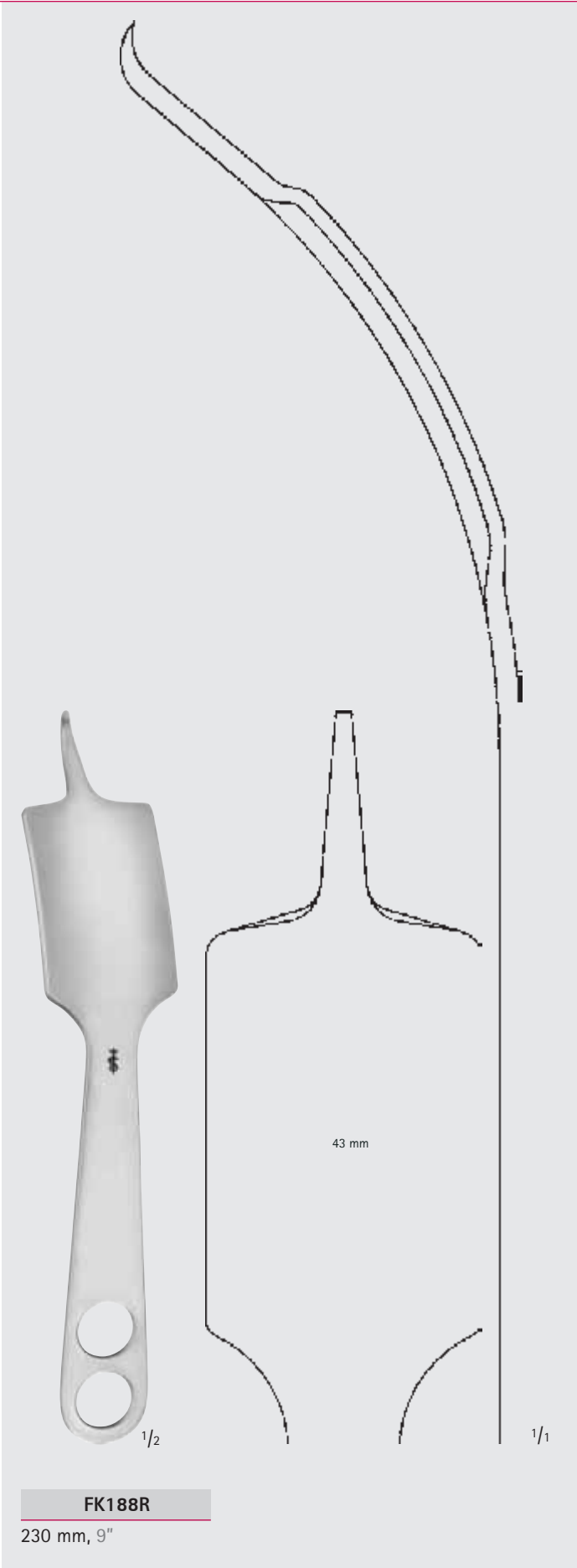

**FK188R**

230 mm, 9"

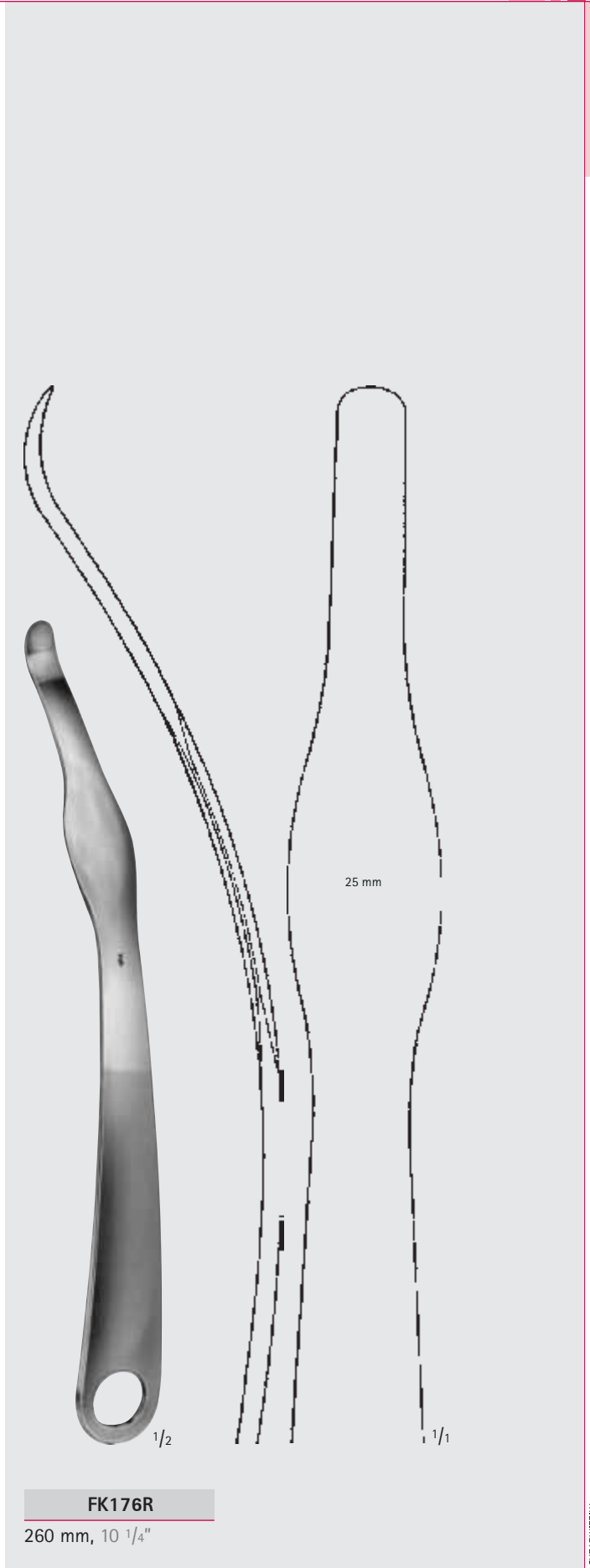

**FK176R**

260 mm, 10 1/4"



MILLIMETERS

# Knochenheber, Raspatorien, Scharfe Löffel – Bone Levers, Elevators, Bone Curettes

Knochenheber

Bone Levers

FK

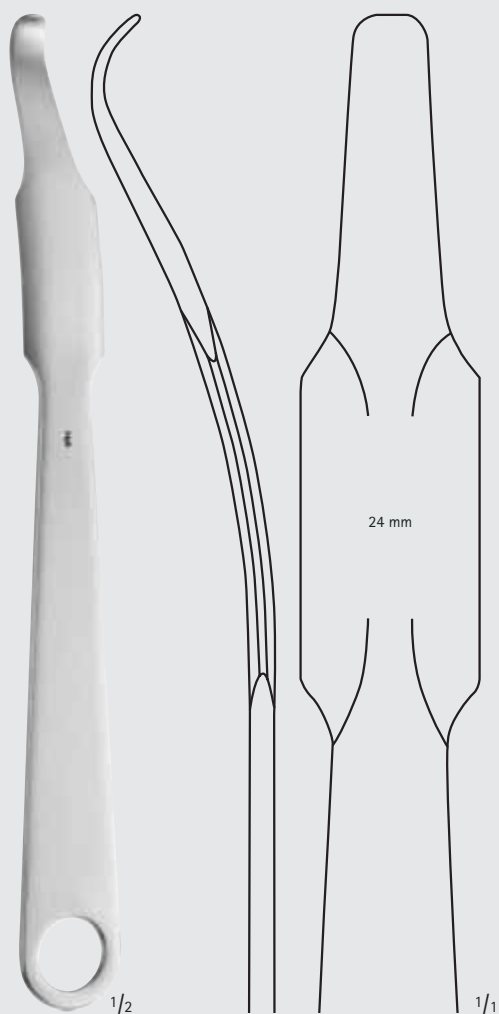

HOHMANN

**FK172R**

260 mm, 10 1/4"

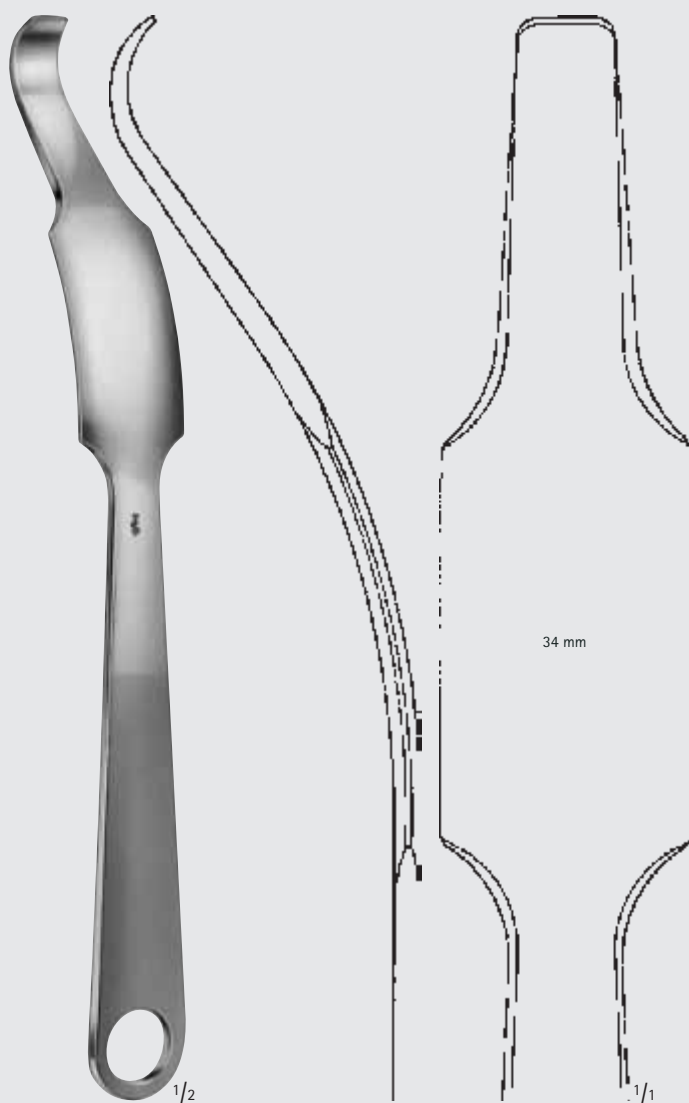

HOHMANN

**FK173R**

285 mm, 11 1/4"





# Knochenheber, Raspatorien, Scharfe Löffel – Bone Levers, Elevators, Bone Curettes

Knochenheber  
Bone Levers

FK

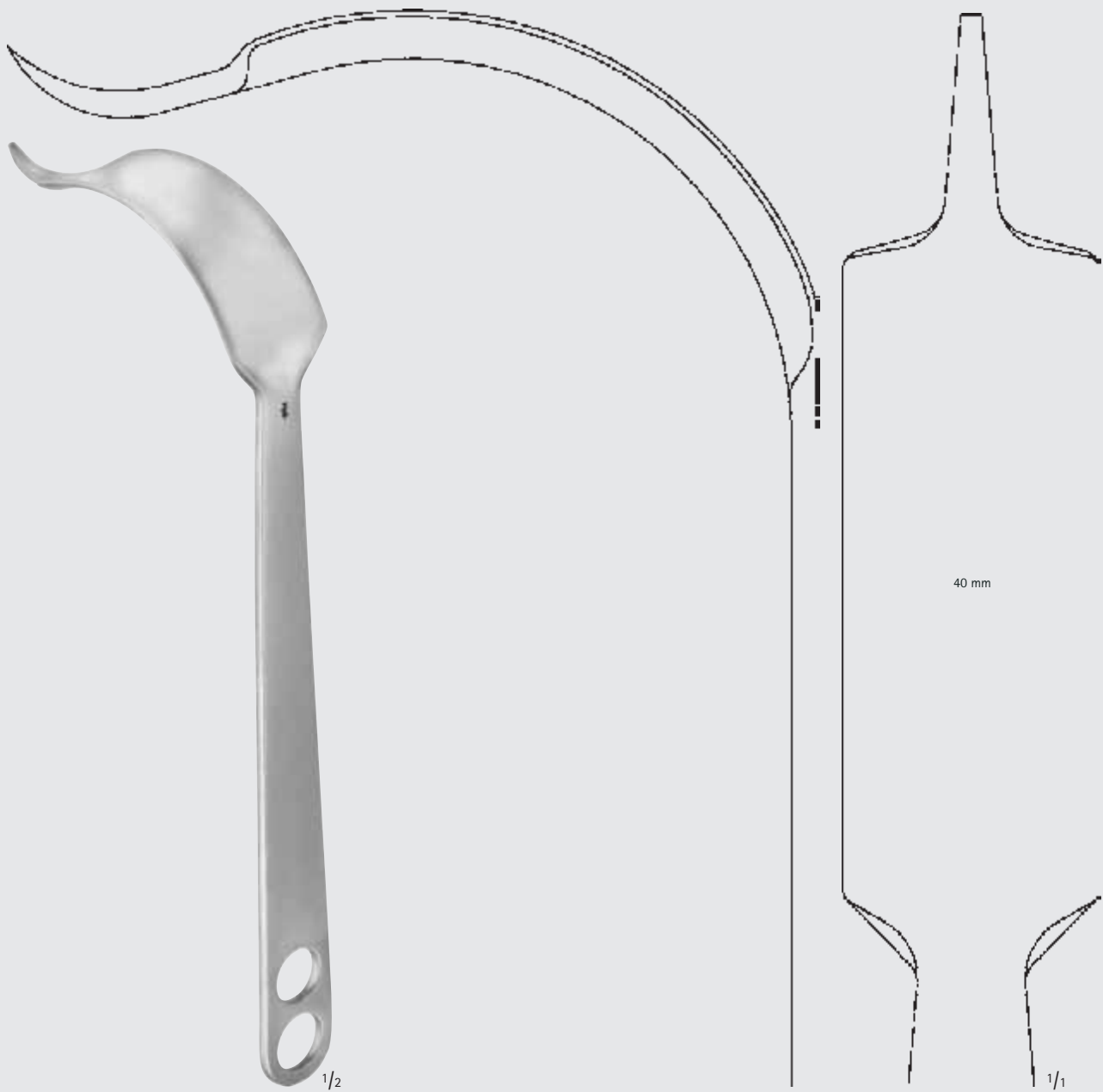

FK189R

290 mm, 11 1/2"

MILLIMETERS

# Knochenheber, Raspatorien, Scharfe Löffel – Bone Levers, Elevators, Bone Curettes

Knochenheber

Bone Levers

FK



1/2

**FK187R**

300 mm, 12"

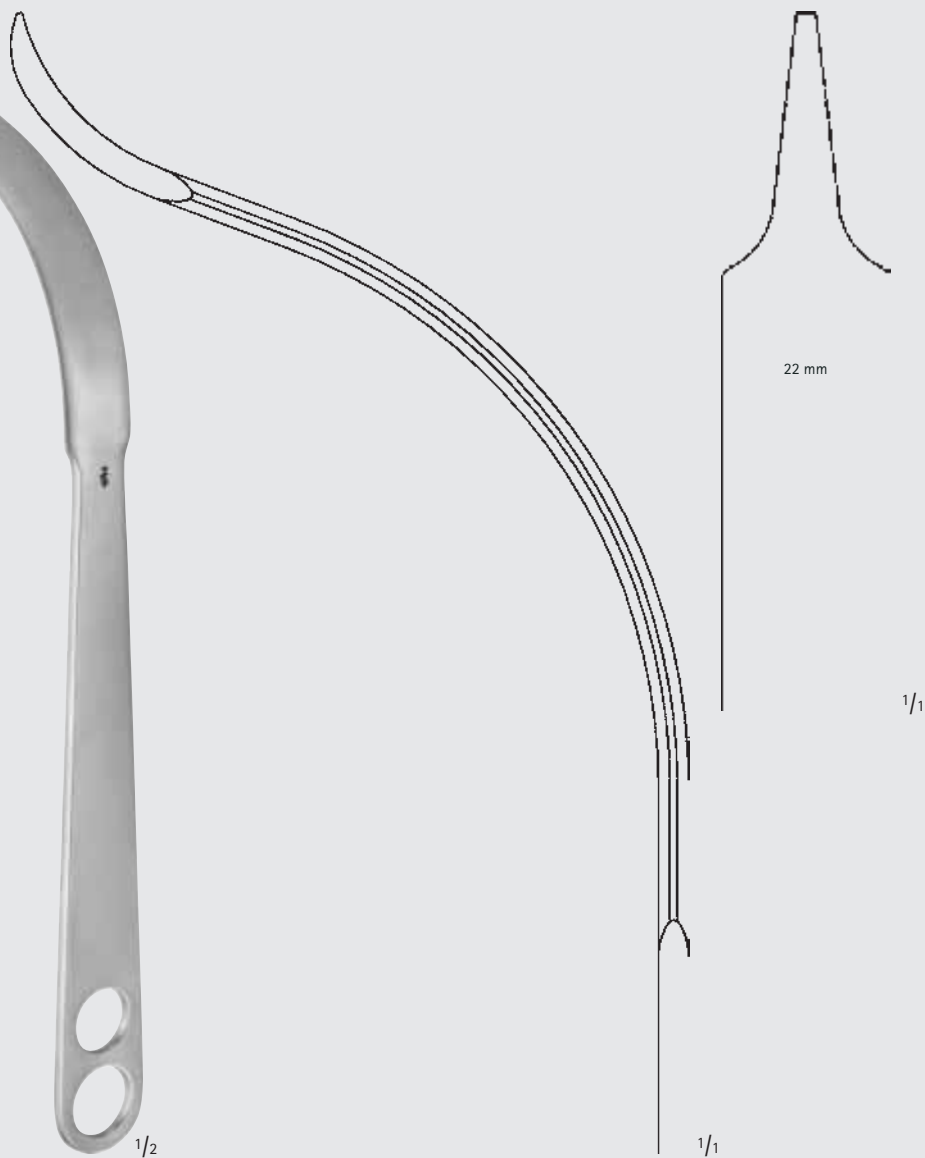

22 mm

1/1

1/1



# Knochenheber, Raspatorien, Scharfe Löffel – Bone Levers, Elevators, Bone Curettes

Knochenheber  
Bone Levers

FK

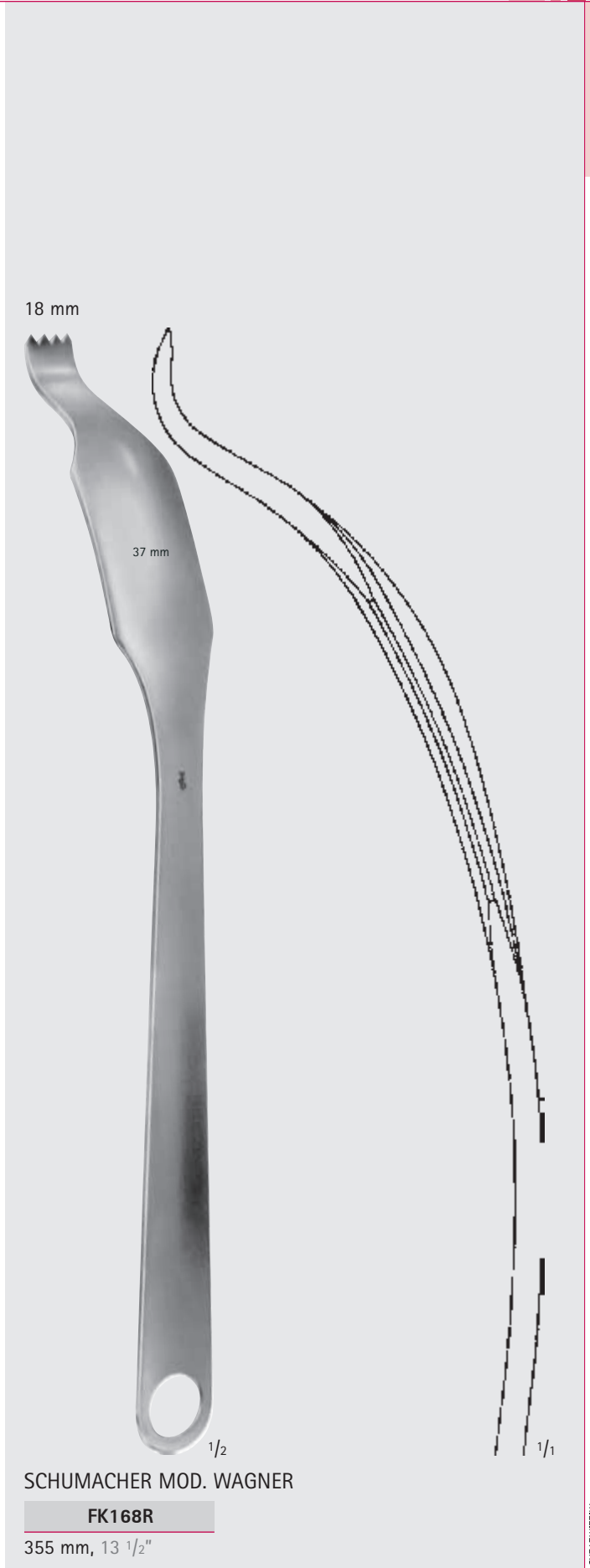
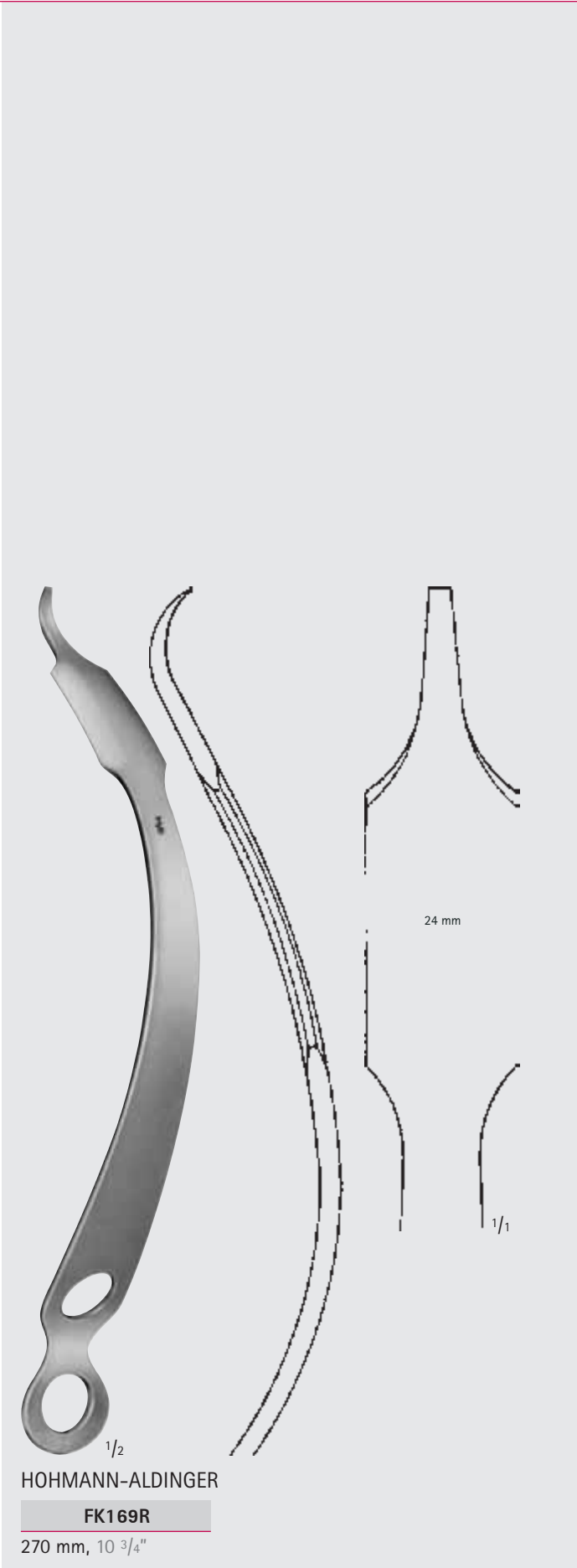

MILLIMETERS

# Knochenheber, Raspatorien, Scharfe Löffel – Bone Levers, Elevators, Bone Curettes

Knochenheber, Spezial-Knochenheber

Bone Levers, Special Bone Levers

FK

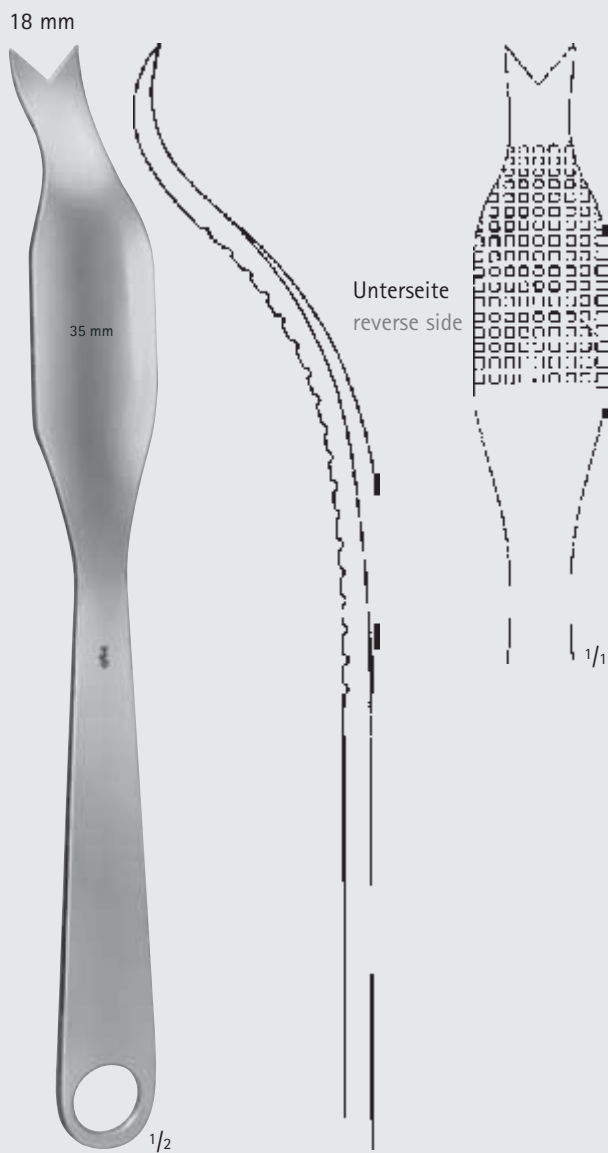

SCHUMACHER

**FK177R**

290 mm, 11 1/2"

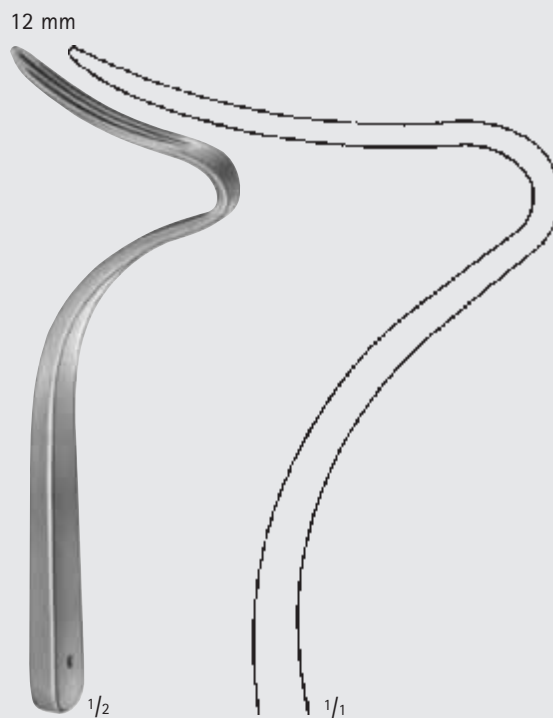

TÄGER

**FK158R**

Knochenheber für Fußgelenkoperationen

Bone lever for angle joint operations

175 mm, 7"



# Knochenheber, Raspatorien, Scharfe Löffel – Bone Levers, Elevators, Bone Curettes

Spezial-Knochenheber  
Special Bone Levers

FK

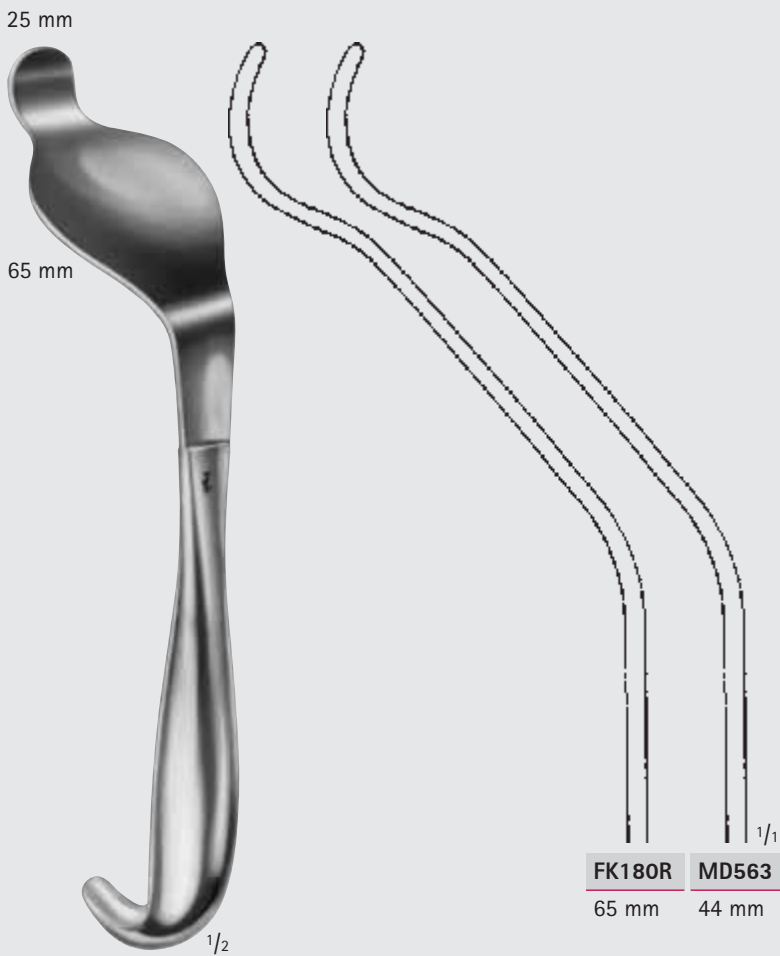

BENNETT

**FK180R-MD563**

235 mm, 9 1/4"



MURPHY-LANE

**FK193R**

Luxationsheber

Luxation lever

330 mm, 13 1/8"



MILLIMETERS

# Knochenheber, Raspatorien, Scharfe Löffel – Bone Levers, Elevators, Bone Curettes

Retraktoren

Retractors

FK

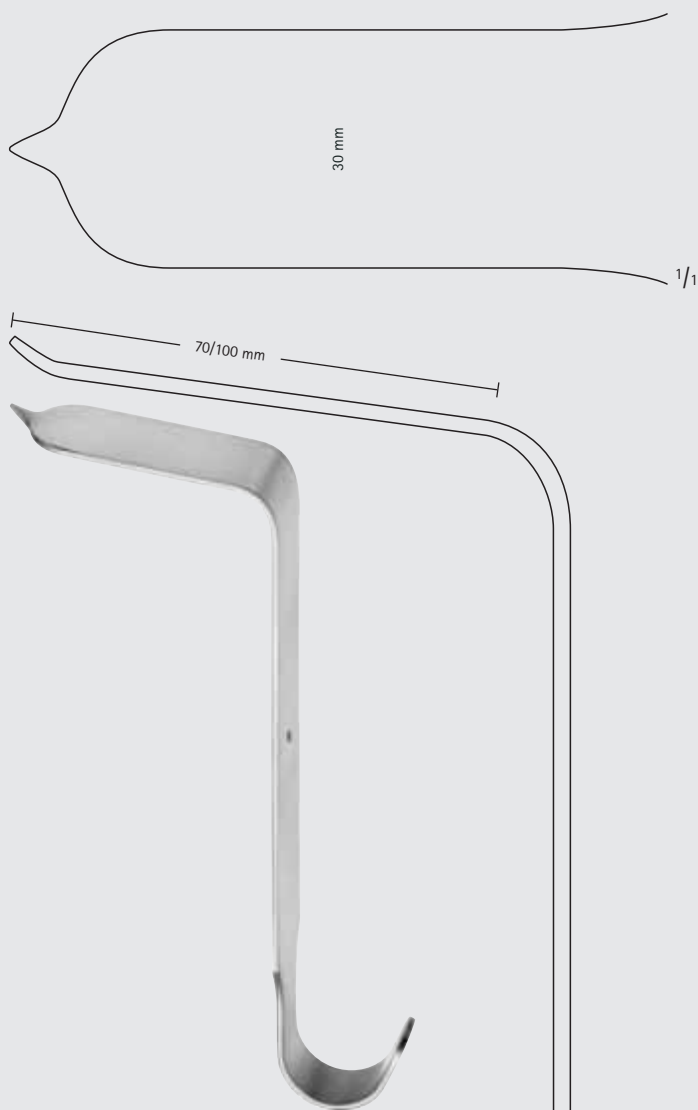

TAYLOR

Blattgröße:  
Blade size:

<b>BT501R</b>	30 x 70 mm	185 mm	7 1/4"
<b>BT502R</b>	30 x 100 mm	200 mm	8"

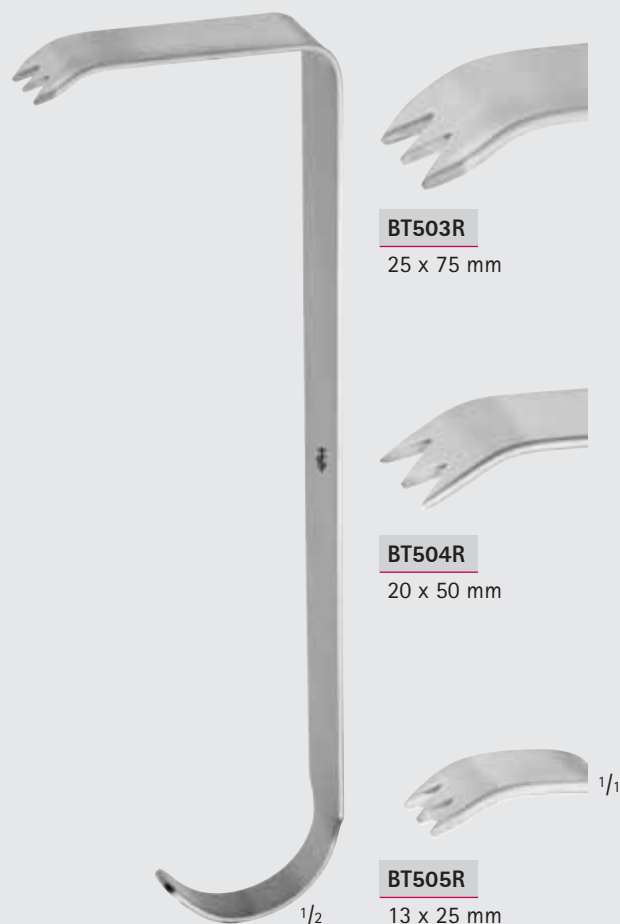

HIBBS

**BT503R–BT505R**

235 mm, 9 1/8"



# Knochenheber, Raspatorien, Scharfe Löffel – Bone Levers, Elevators, Bone Curettes

MIOS Retraktoren

MIOS Retractors

**FK**

90°

**FK213R**

**FK212R**

**FK211R**

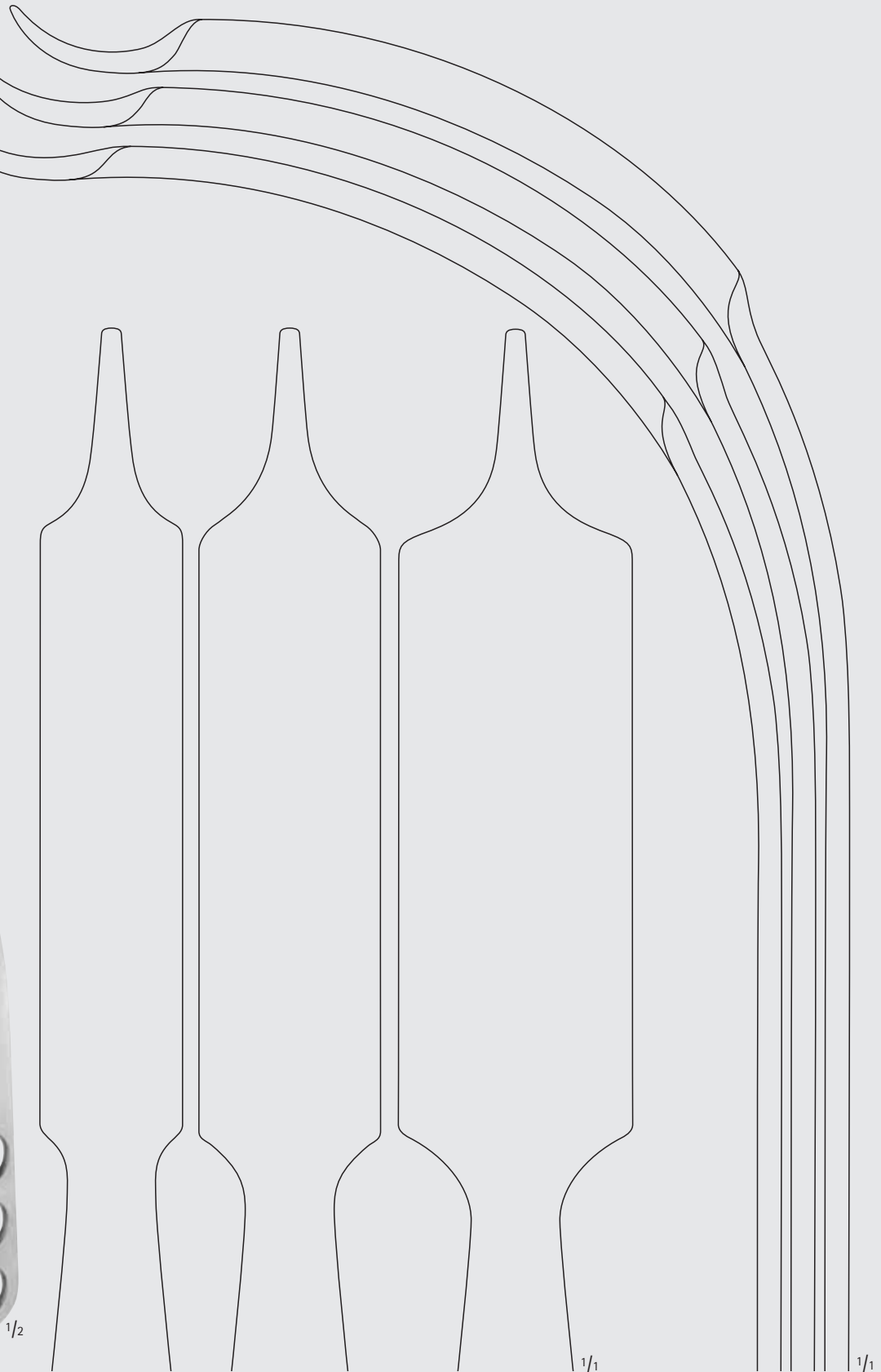

**FK211R-FK213R**

scharfe Spitze  
sharp tip  
240 mm, 9 1/2"

**FK211R**

22 mm

**FK212R**

28 mm

**FK213R**

40 mm

MILLIMETERS

# Knochenheber, Raspatorien, Scharfe Löffel – Bone Levers, Elevators, Bone Curettes

MIOS Retraktoren

MIOS Retractors

90°

FK219R

FK218R

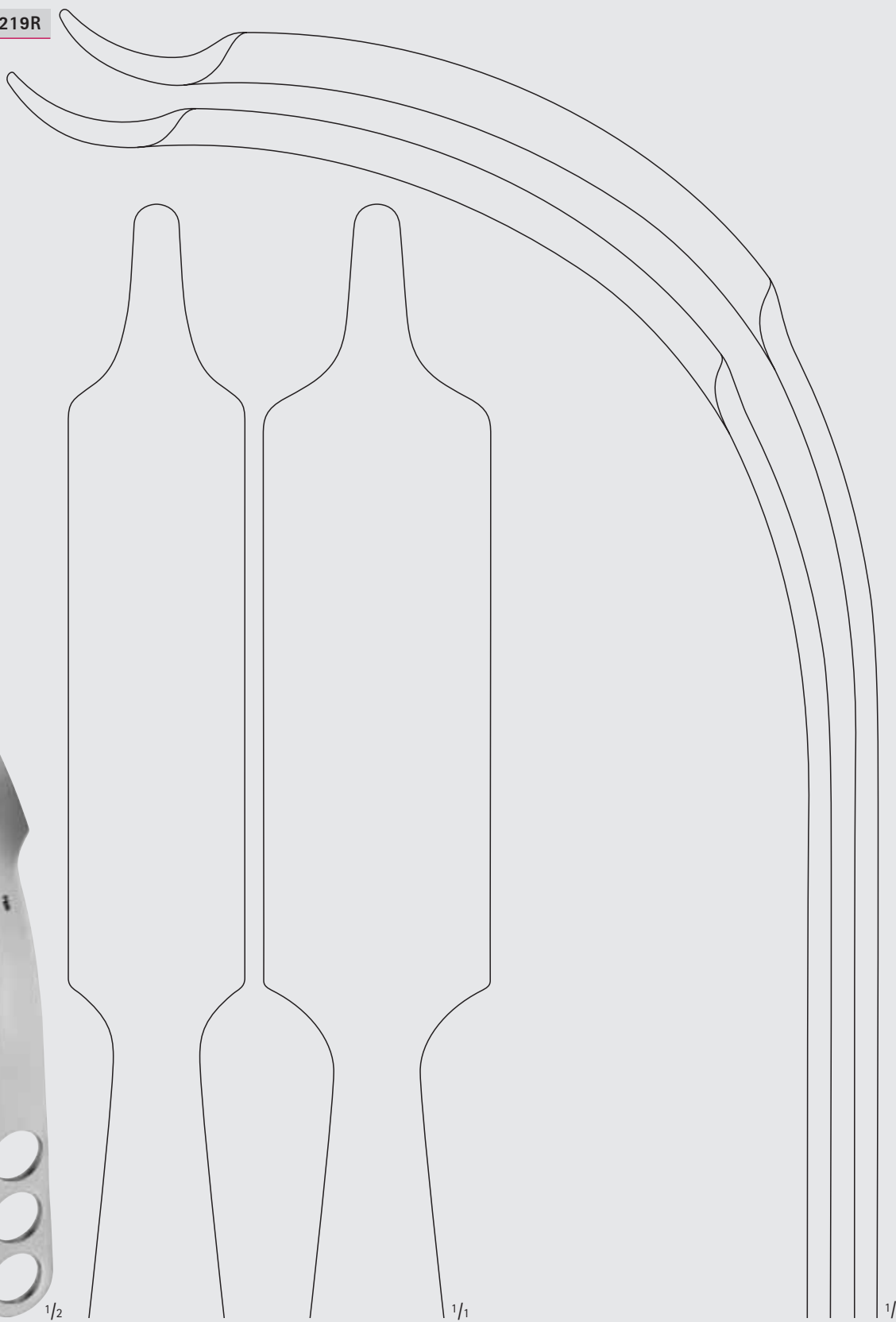

FK218R-FK219R

stumpfe Spitze  
blunt tip  
240 mm, 9 1/2"

FK218R

28 mm

FK219R

40 mm

1/2

1/1

1/1

INCHES





# Knochenheber, Raspatorien, Scharfe Löffel – Bone Levers, Elevators, Bone Curettes

MIOS Retraktoren

MIOS Retractors

FK

90°

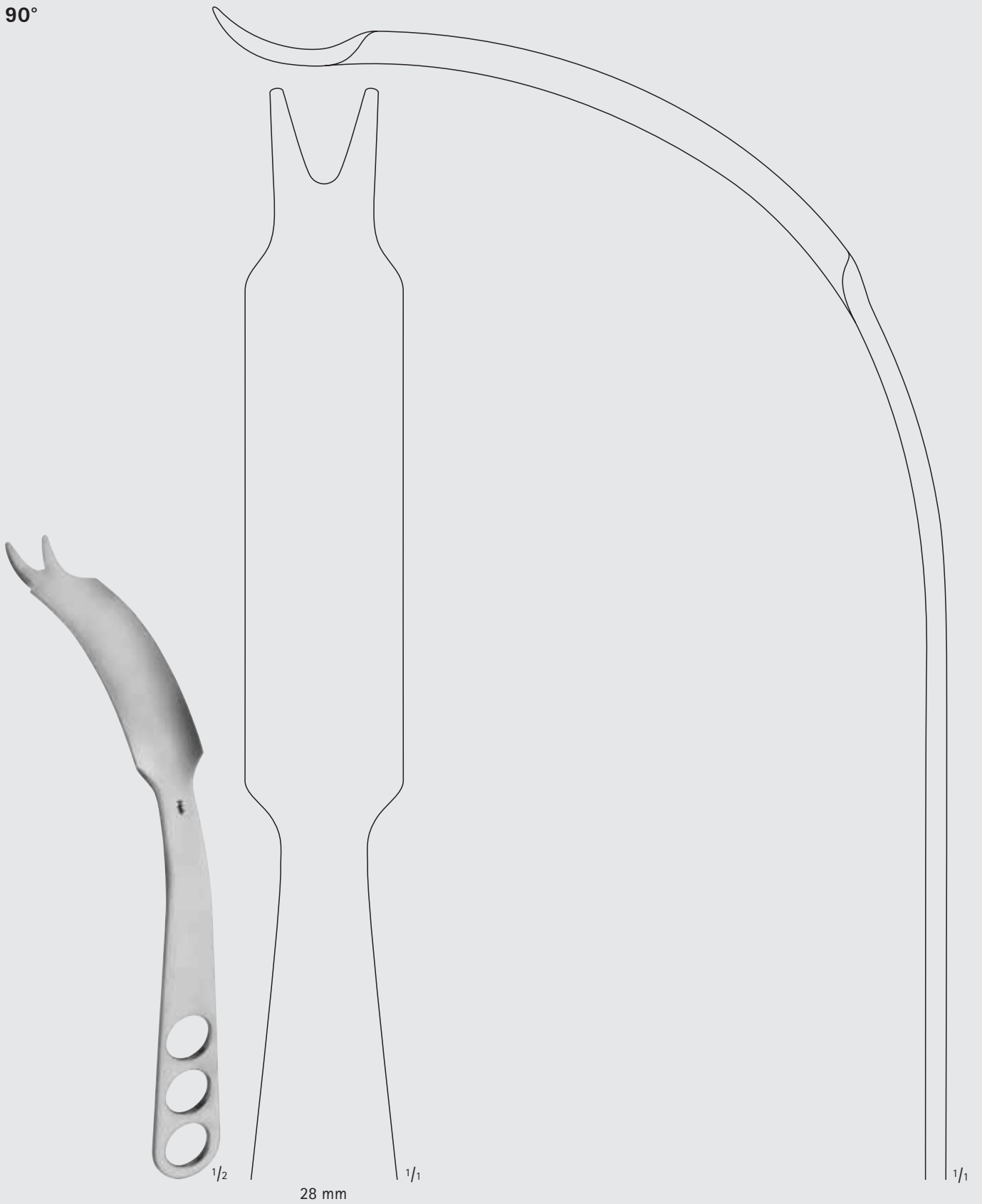

FK224R

V-Spitze

V-tip

240 mm, 9 1/2"

MILLIMETERS

# Knochenheber, Raspatorien, Scharfe Löffel – Bone Levers, Elevators, Bone Curettes

MIOS Retraktoren

MIOS Retractors

90°

FK214R

FK215R



1/2

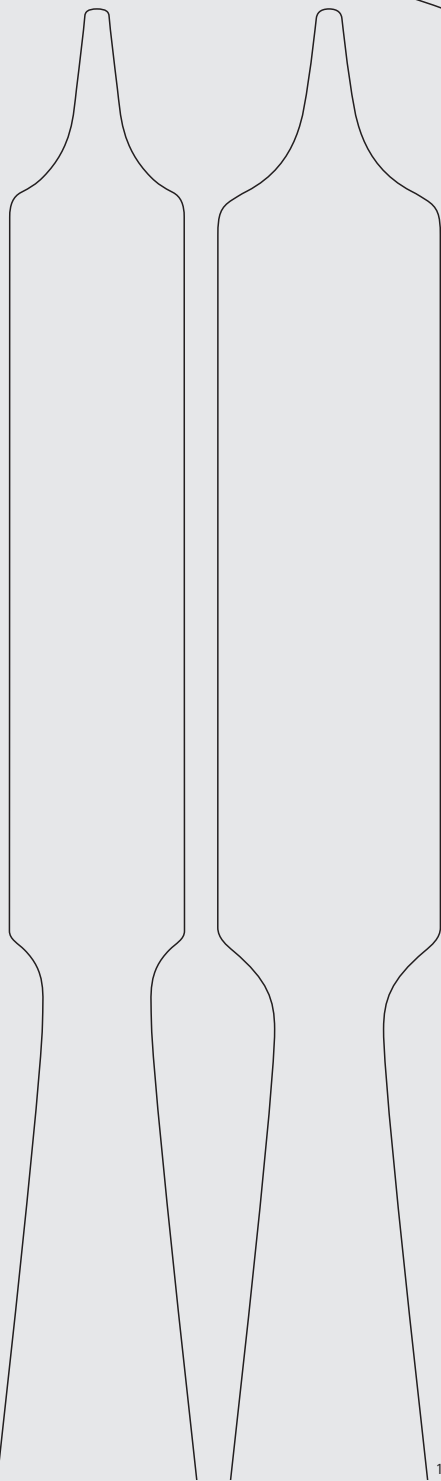

FK214R

22 mm

FK215R

28 mm

1/1

1/1

FK214R-FK215R

kurze Spitze

short tip

240 mm, 9 1/2"

INCHES



# Knochenheber, Raspatorien, Scharfe Löffel – Bone Levers, Elevators, Bone Curettes

MIOS Retraktoren

MIOS Retractors

FK

90°

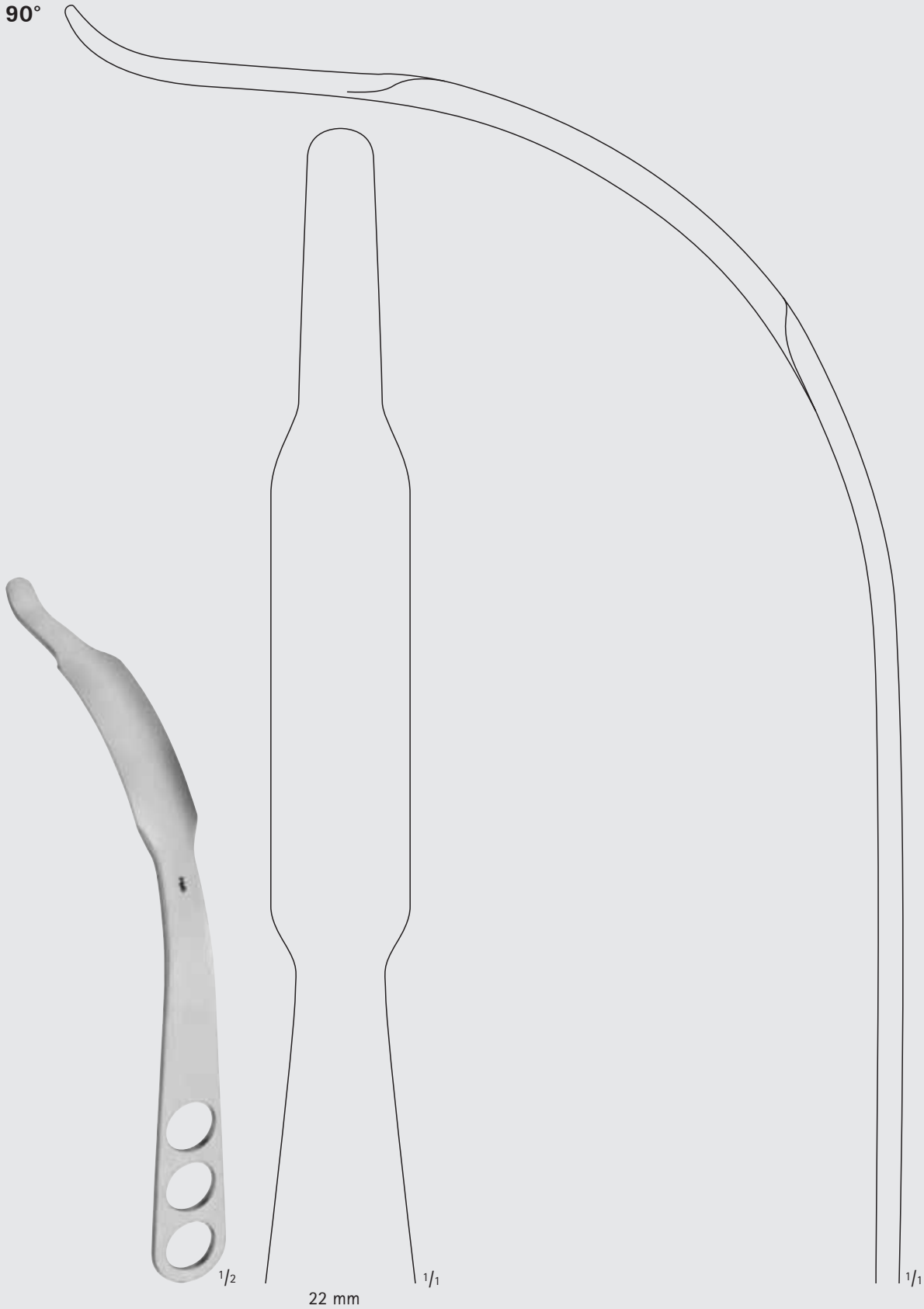

**FK239R**

Schenkelhals-Spitze

femoral neck tip

240 mm, 9 1/2"

MILLIMETERS

# Knochenheber, Raspatorien, Scharfe Löffel – Bone Levers, Elevators, Bone Curettes

MIOS Retraktoren

MIOS Retractors

FK

60°

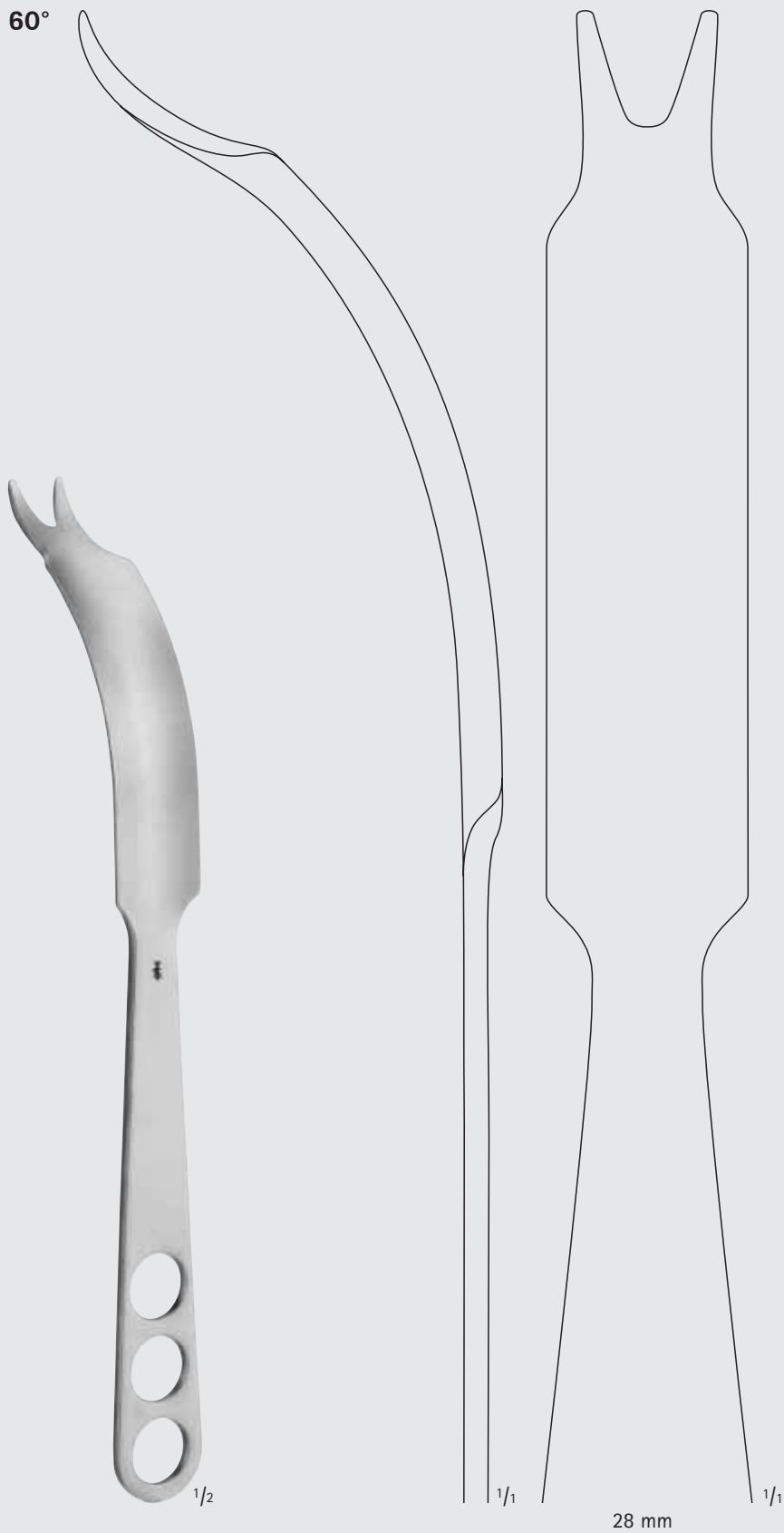

FK223R

V-Spitze

V-tip

300 mm, 12"



# Knochenheber, Raspatorien, Scharfe Löffel – Bone Levers, Elevators, Bone Curettes

MIOS Retraktoren

MIOS Retractors

**FK**

45°

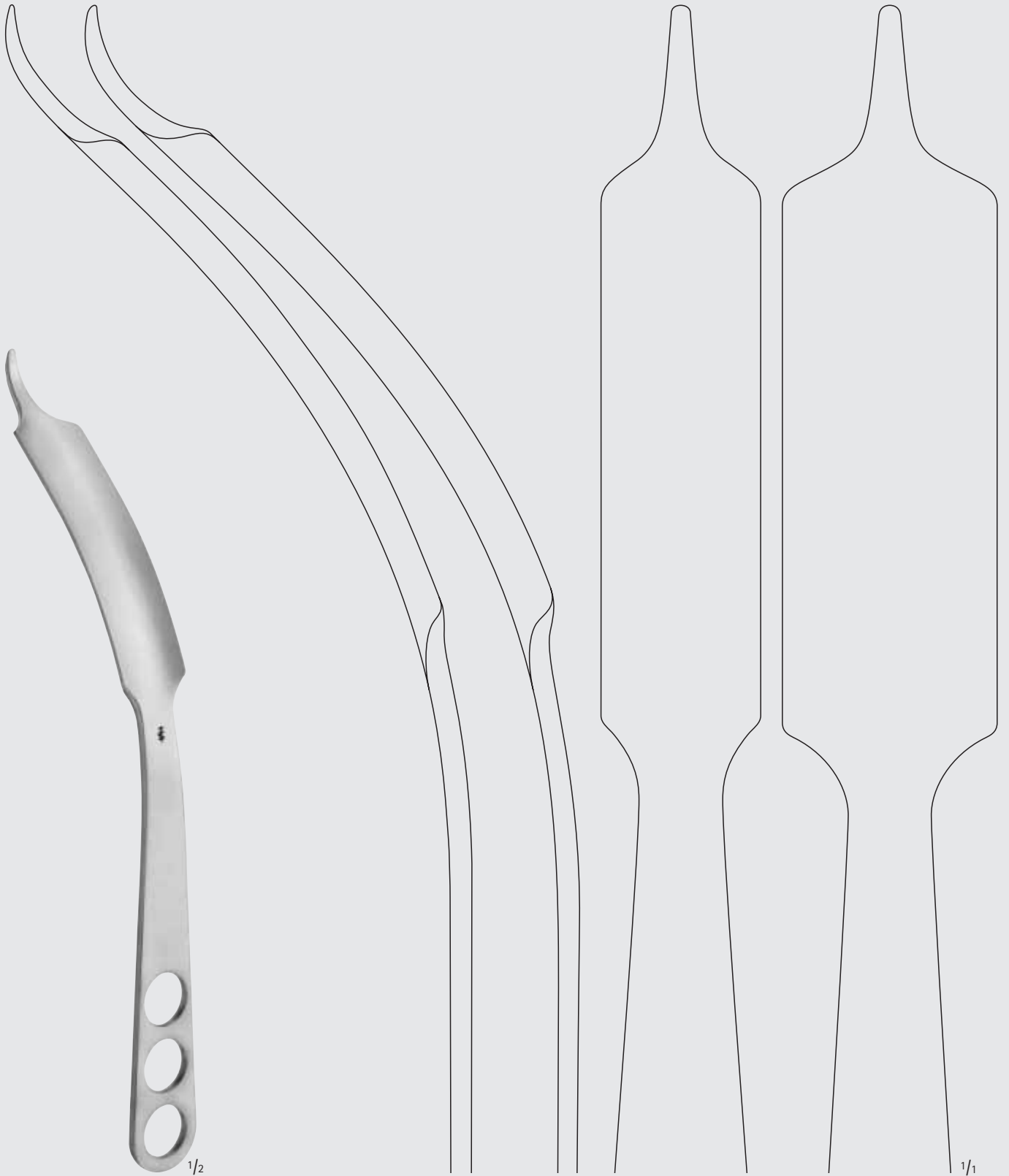

1/2

1/1

**FK243R-FK245R**

scharfe Spitze

sharp tip

300 mm, 12"

**FK243R**

28 mm

**FK245R**

40 mm

MILLIMETERS

# Knochenheber, Raspatorien, Scharfe Löffel – Bone Levers, Elevators, Bone Curettes

MIOS Retraktoren

MIOS Retractors

45°

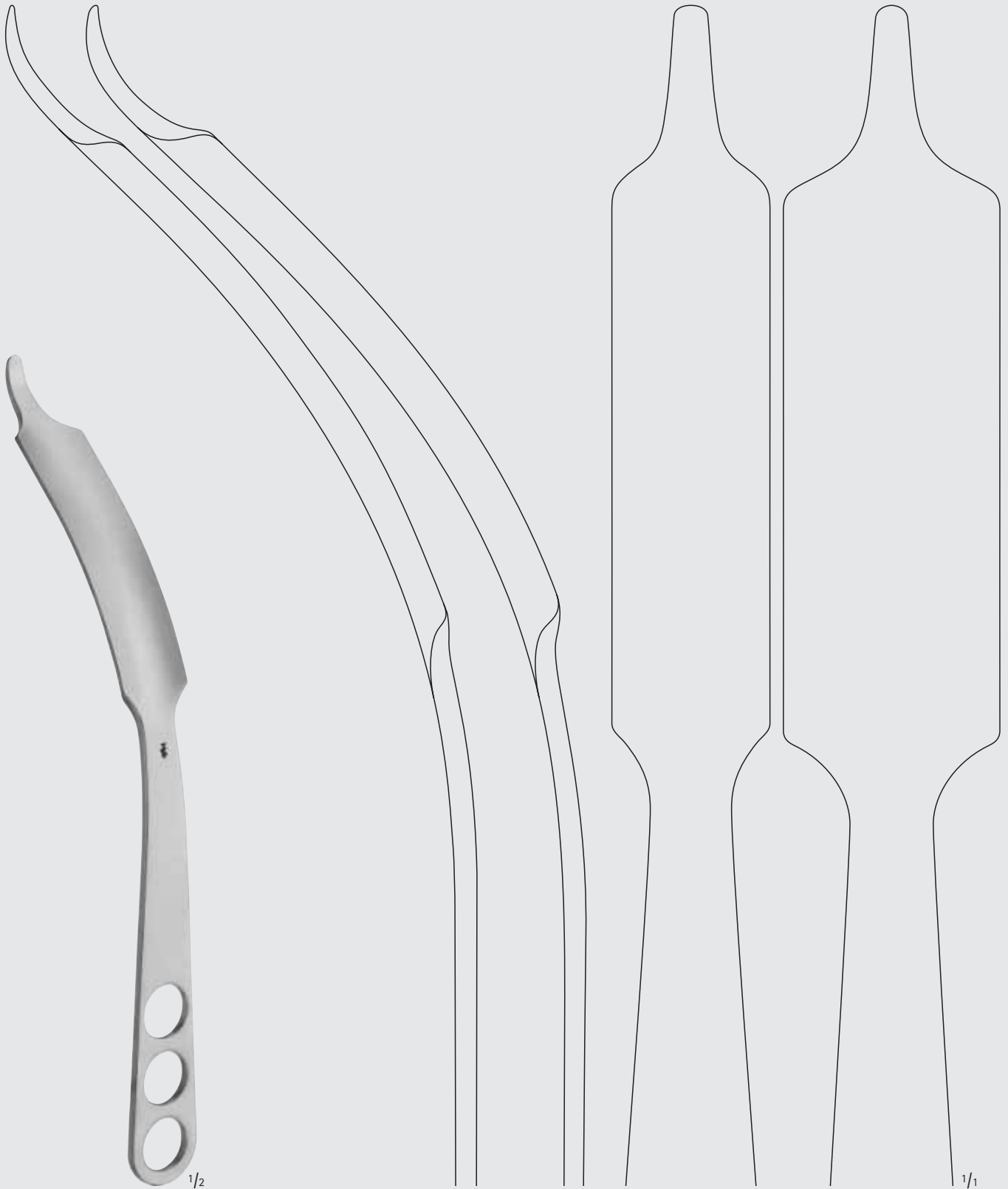

**FK244R-FK246R**

stumpfe Spitze

blunt tip

300 mm, 12"

**FK244R**

28 mm

**FK246R**

40 mm



# Knochenheber, Raspatorien, Scharfe Löffel – Bone Levers, Elevators, Bone Curettes

MIOS Retraktoren

MIOS Retractors

FK

45°

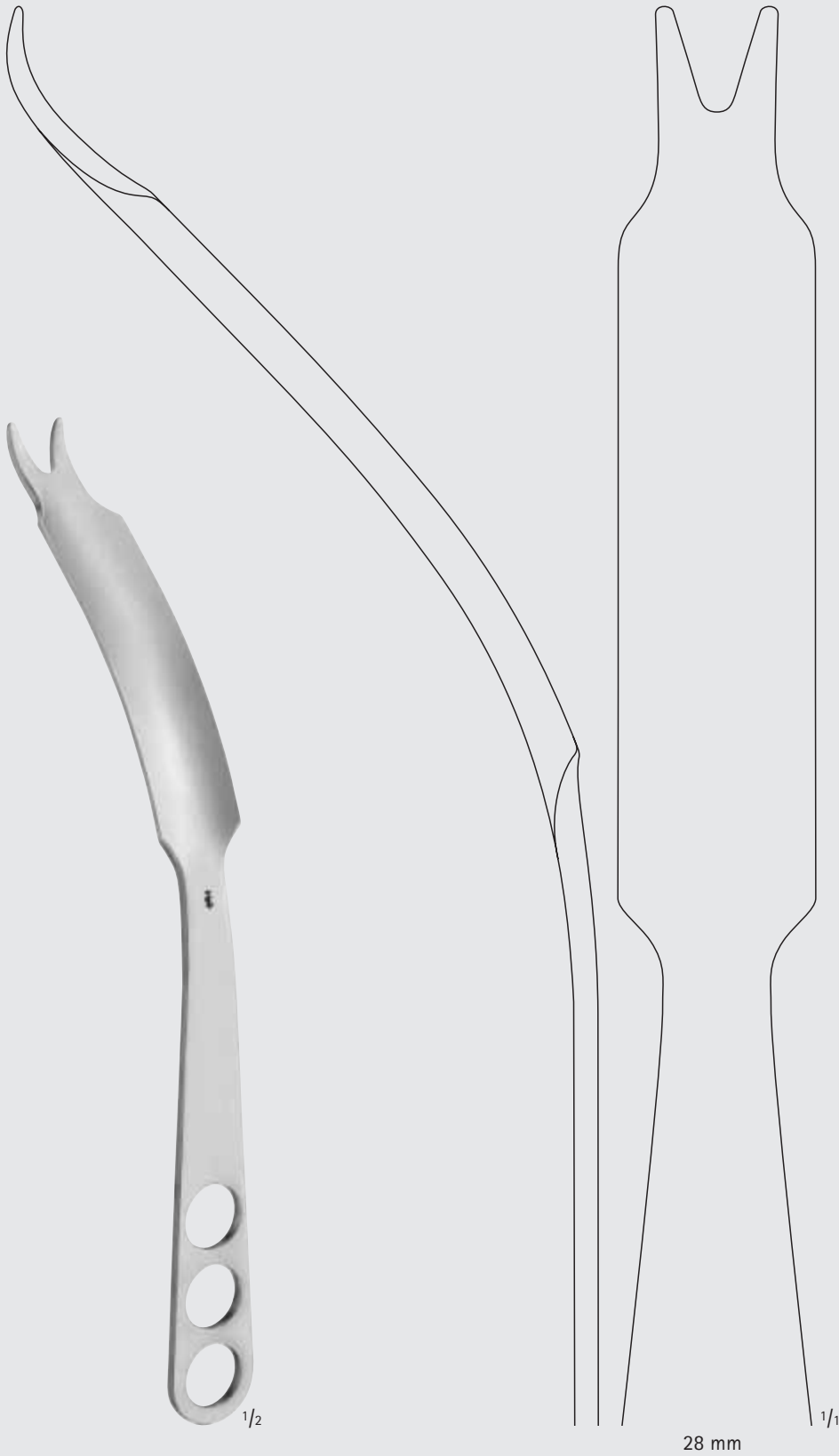

FK222R

V-Spitze

V-tip

300 mm, 12"



# Knochenheber, Raspatorien, Scharfe Löffel – Bone Levers, Elevators, Bone Curettes

MIOS Retraktoren

MIOS Retractors

30°

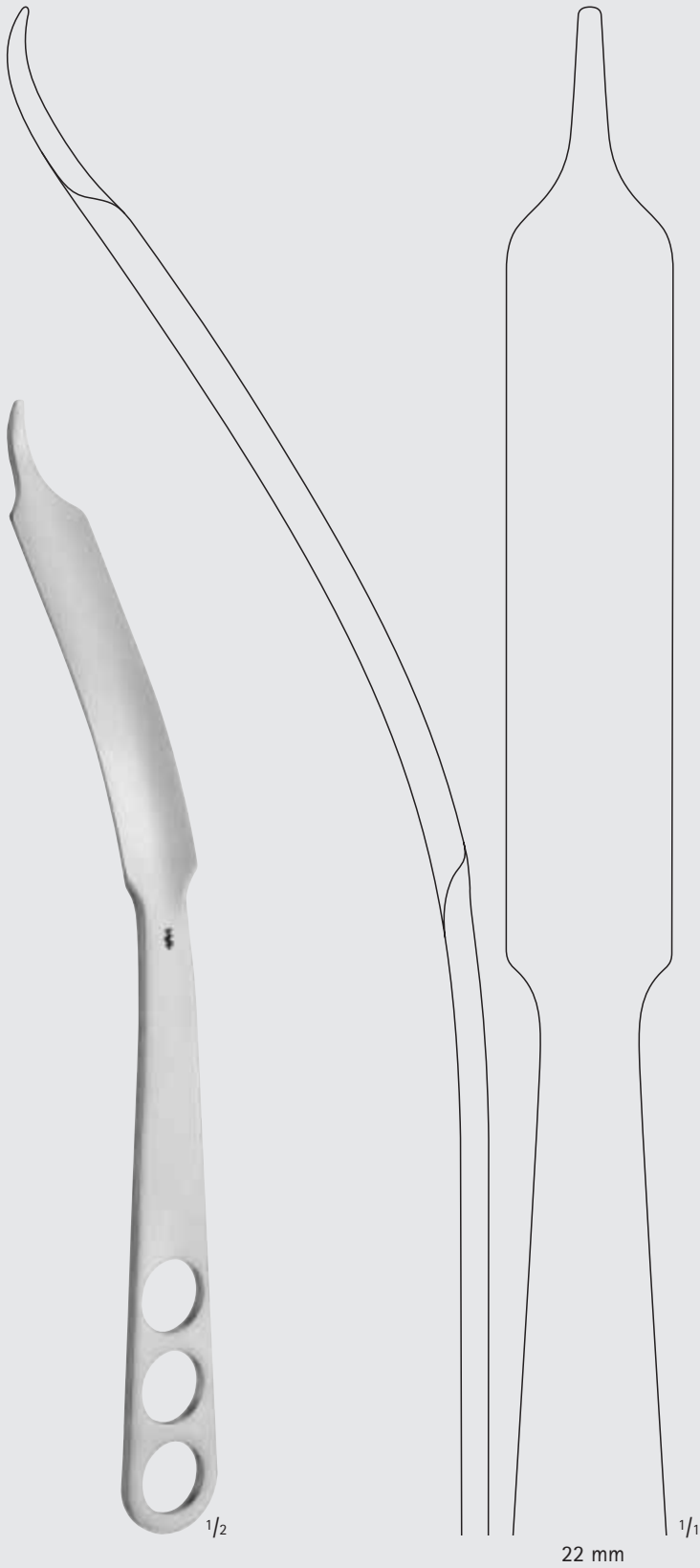

**FK241R**

scharfe Spitze

sharp tip

315 mm, 12 1/2"

INCHES





# Knochenheber, Raspatorien, Scharfe Löffel – Bone Levers, Elevators, Bone Curettes

MIOS Retraktoren

MIOS Retractors

FK

30°

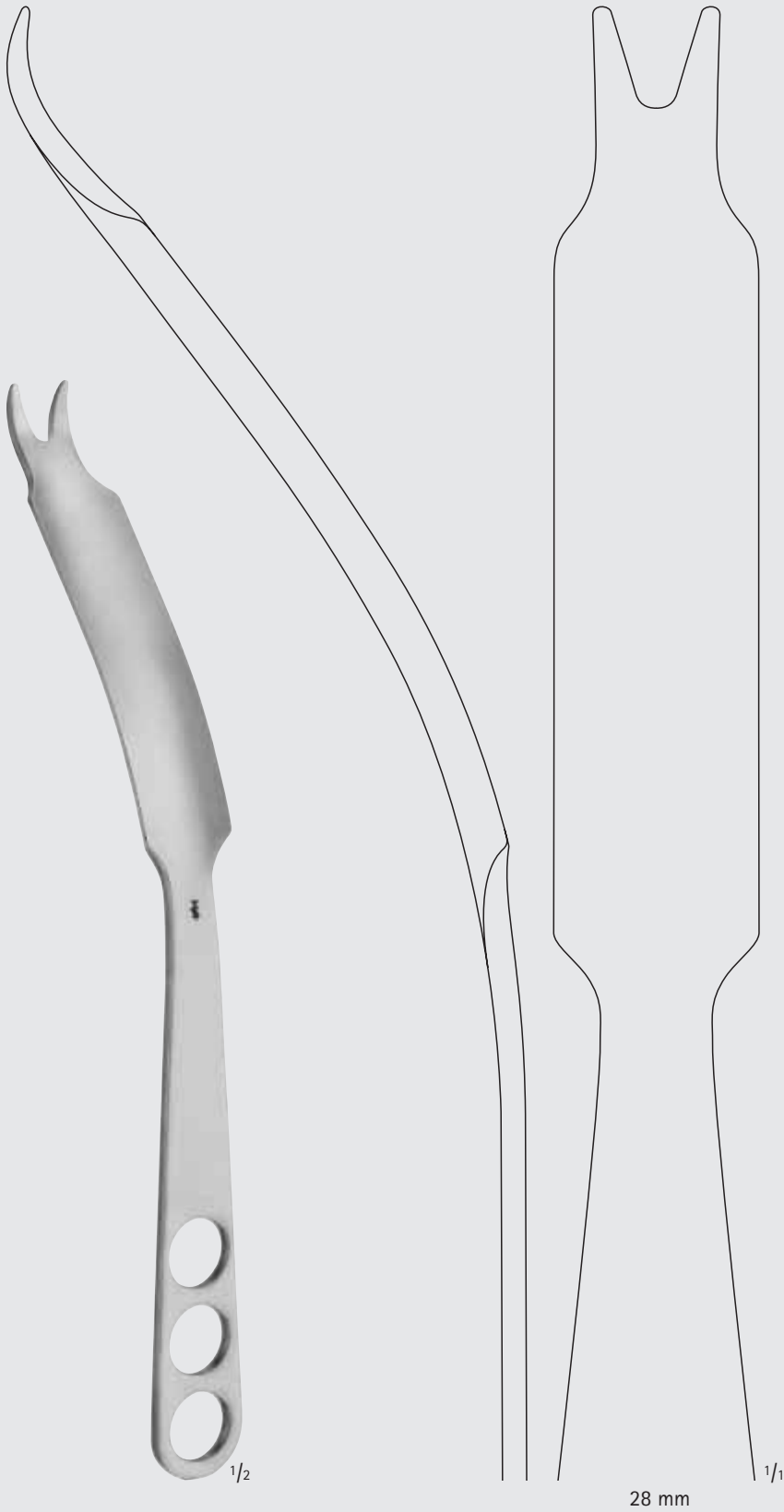

FK221R

V-Spitze

V-tip

315 mm, 12 1/2"

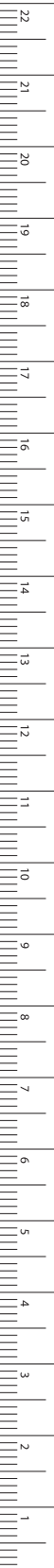

MILLIMETERS

# Knochenheber, Raspatorien, Scharfe Löffel – Bone Levers, Elevators, Bone Curettes

MIOS Retraktoren

MIOS Retractors

30°

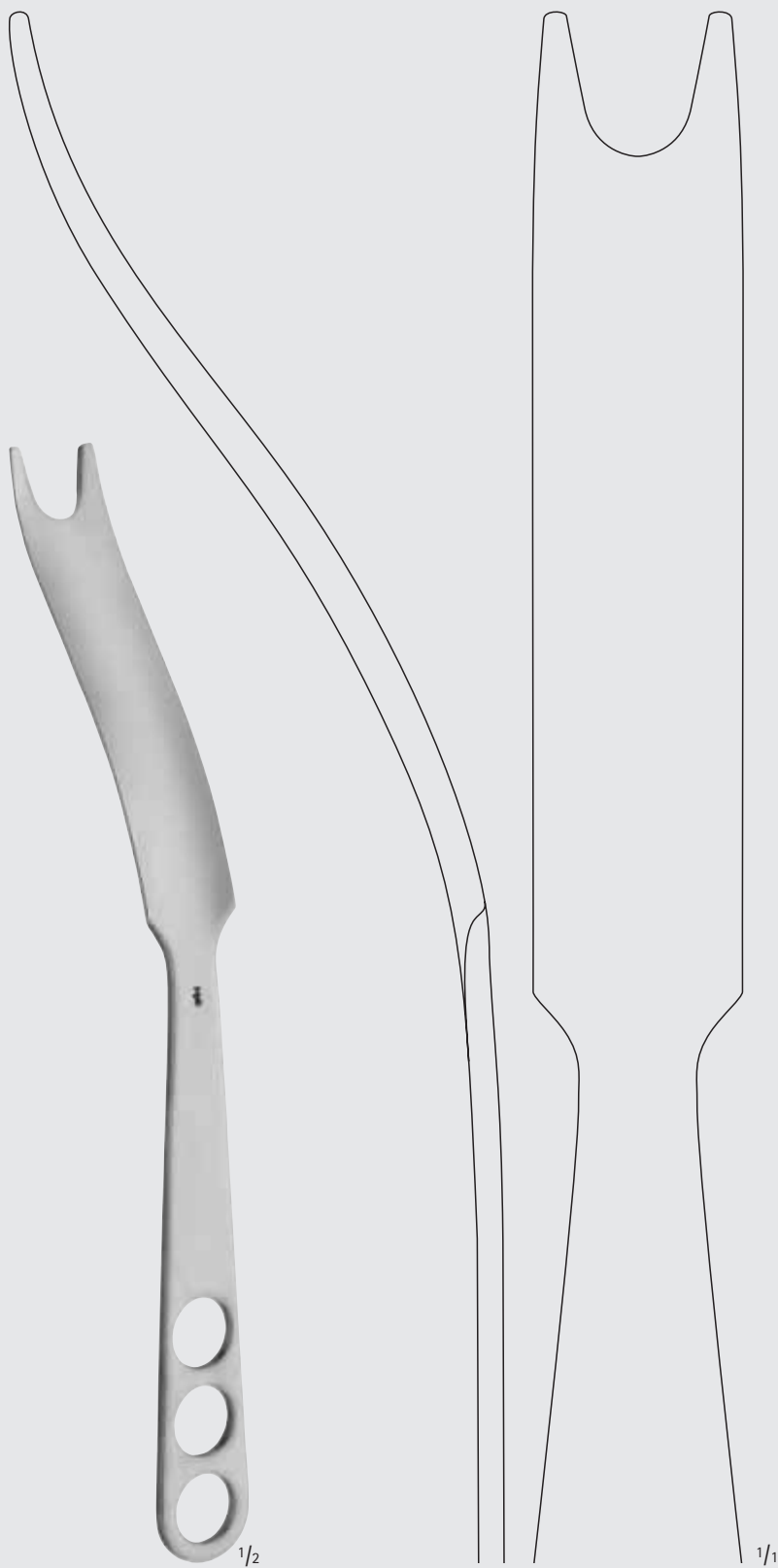

**FK231R**

U-Spitze

U-tip

315 mm, 12 1/2"

28 mm

1/2

1/1

INCHES

# Knochenheber, Raspatorien, Scharfe Löffel – Bone Levers, Elevators, Bone Curettes

MIOS Retraktoren

MIOS Retractors

FK

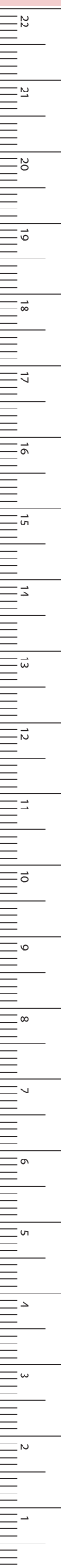

30°

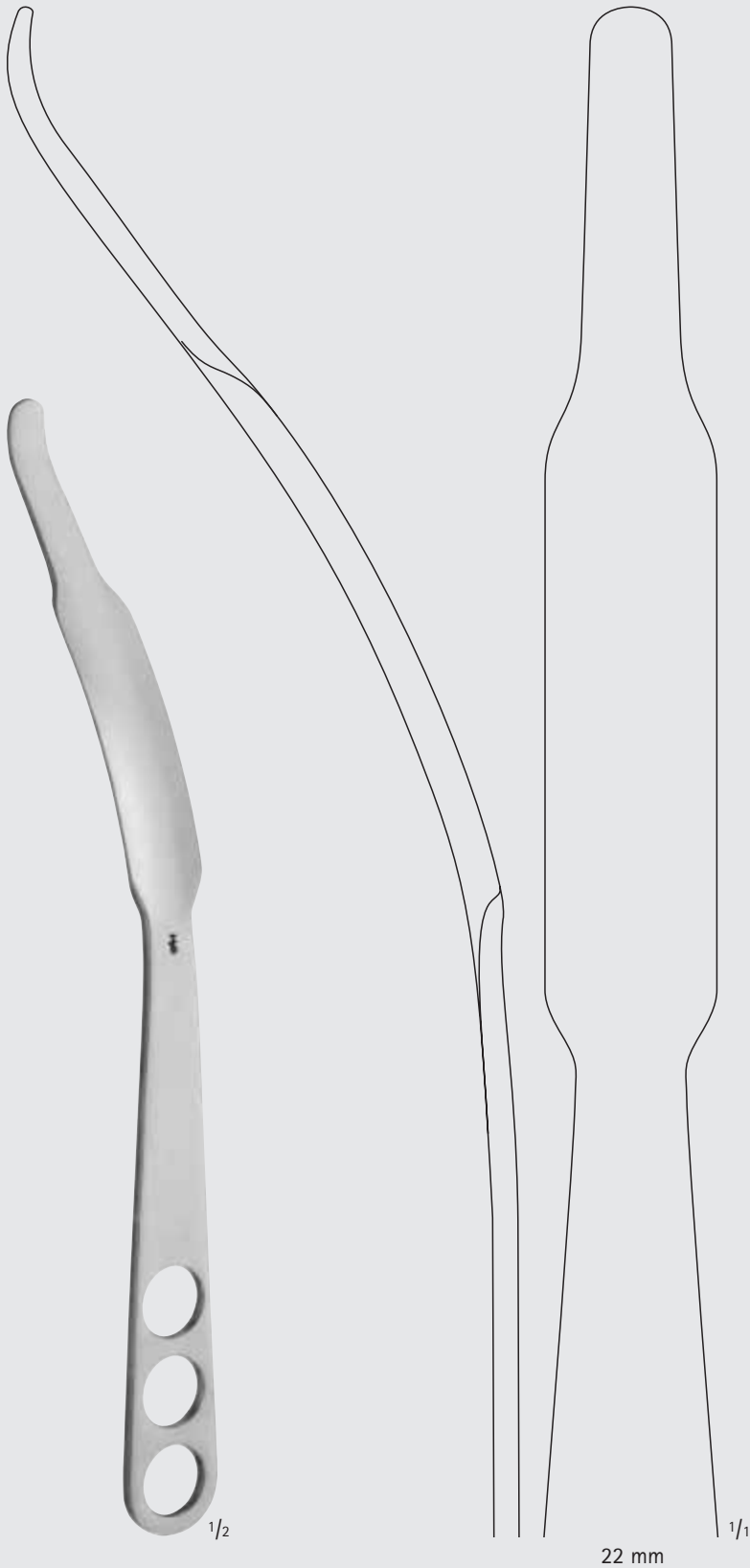

**FK238R**

Schenkelhals-Spitze  
femoral neck tip  
315 mm, 12 1/2"



### Farbige MIOS Standardgriffe

Die farbigen Griffe können zur intraoperativen Zuordnung der MIOS Instrumente verwendet werden.

### Colored MIOS standard hand grips

The colored hand grips can be used for the intra-operative allocation of the MIOS instruments.



**FK251**

MIOS Standardgriff  
MIOS standard hand grip



**FK252**

MIOS Standardgriff  
MIOS standard hand grip



**FK253**

MIOS Standardgriff  
MIOS standard hand grip



**FK254**

MIOS Standardgriff  
MIOS standard hand grip

MILLIMETERS

# Knochenheber, Raspatorien, Scharfe Löffel – Bone Levers, Elevators, Bone Curettes

Raspatorien

Raspatories

FK

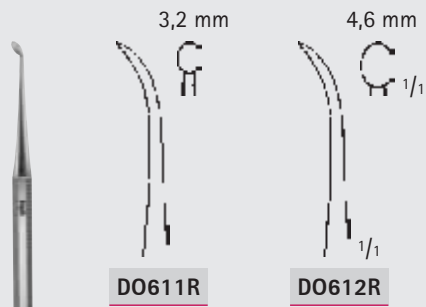

DO611R

DO612R

1/2

PARTSCH

DO611R-DO612R

150 mm, 6"

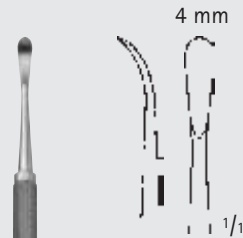

1/2

PARTSCH MOD. LANGE

DO642R

145 mm, 5 3/4"



1/2

MC KENTY

OL192R

115 mm, 6"

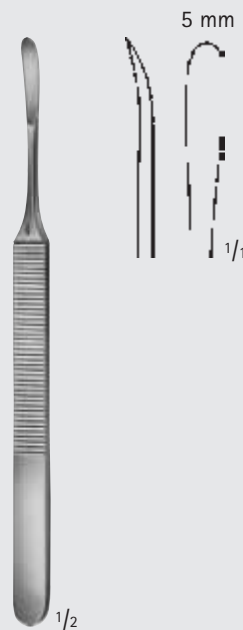

1/2

KÖNIG

OM309R

155 mm, 6"

# Knochenheber, Raspatorien, Scharfe Löffel – Bone Levers, Elevators, Bone Curettes

Raspatorien  
Raspatories

**FK**

8 mm  
1/1

**TRELAT**  
**OM311R**  
150 mm, 6"

4 mm 4 mm  
1/1

**OM314R-OM315R**  
140 mm, 5 1/2"

4,2 mm  
1/1

**WILLIGER**  
**D0510R**  
140 mm, 5 1/2"

6 mm 8 mm  
1/1

**WILLIGER**  
**FK300R-FK303R**  
160 mm, 6 1/4"

5,5 mm  
1/1

**WARD**  
**D0546R**  
170 mm, 6 3/4"

4 mm  
1/1

**JOSEPH**  
**FK310R**  
180 mm, 7"



# Knochenheber, Raspatorien, Scharfe Löffel – Bone Levers, Elevators, Bone Curettes

Raspatorien

Raspatories

FK



LEMPERT

**OG165R**

Raspatorium, stumpf

Raspatory, blunt

165 mm, 6 1/2"

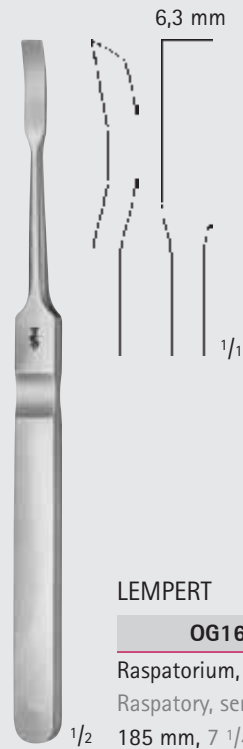

LEMPERT

**OG164R**

Raspatorium, halbscharf

Raspatory, semi-sharp

185 mm, 7 1/4"



ALLEN

**FF346R**

Osteophytenmeißel und Schaber

Osteophyte chisel and scraper

230 mm, 9"



# Knochenheber, Raspatorien, Scharfe Löffel – Bone Levers, Elevators, Bone Curettes

Raspatorien  
Raspatories

**FK**

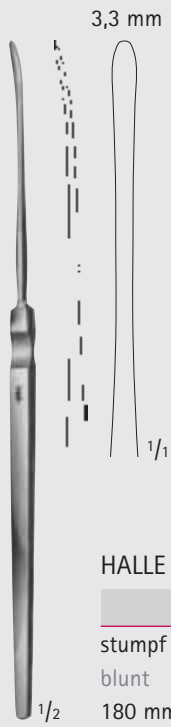

HALLE

**OL160R**

stumpf

blunt

180 mm, 7"



FREER

**OL163R**

stumpf

blunt

190 mm, 7 1/2"



FREER

**OL162R**

scharf

sharp

190 mm, 7 1/2"



SEWALL

**OL198R**

stumpf

blunt

200 mm, 8"

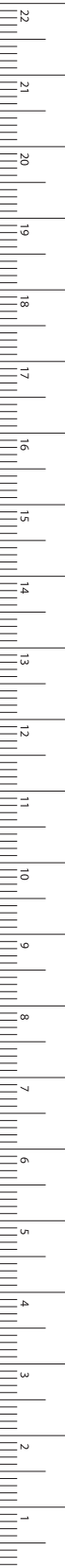

MILLIMETERS

# Knochenheber, Raspatorien, Scharfe Löffel – Bone Levers, Elevators, Bone Curettes

Raspatorien

Raspatories

FK

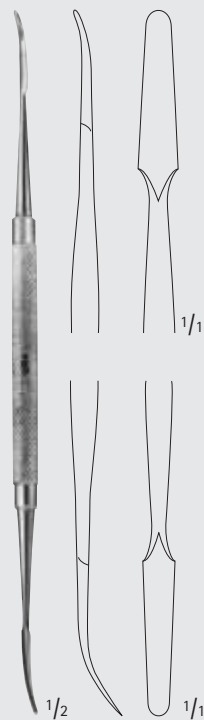

KILLIAN

**OL170R**

scharf/stumpf  
sharp/blunt

185 mm, 7 1/4"



HOWARTH

**OL171R**

scharf/stumpf  
sharp/blunt

215 mm, 8 1/2"

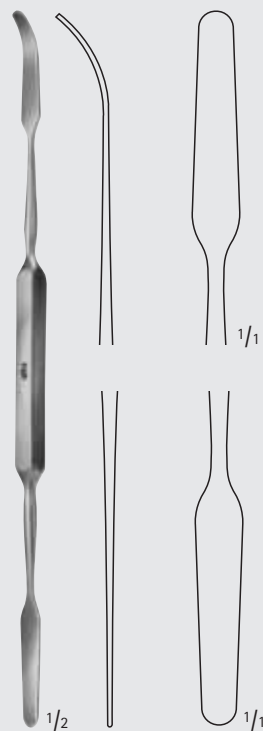

MAC DONALD

**FK291R**

stumpf/stumpf  
blunt/blunt

190 mm, 7 1/2"

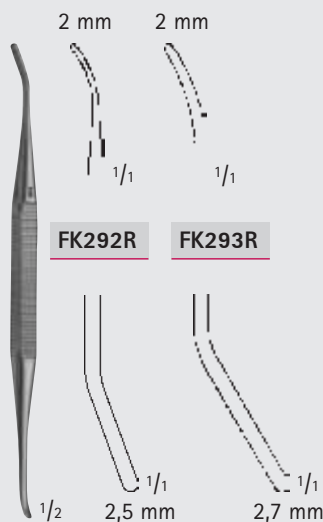

WATSON-CHEYNE

**FK292R** 130 mm 5 1/8"

**FK293R** 190 mm 7 1/2"



FREER

**OL164R**

180 mm, 7"





# Knochenheber, Raspatorien, Scharfe Löffel – Bone Levers, Elevators, Bone Curettes

Raspatorien  
Raspatories

**FK**

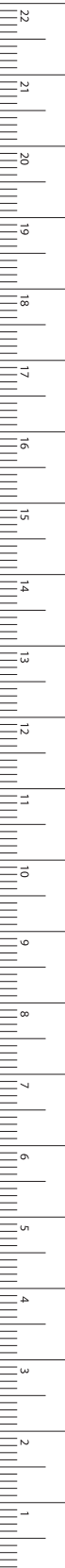
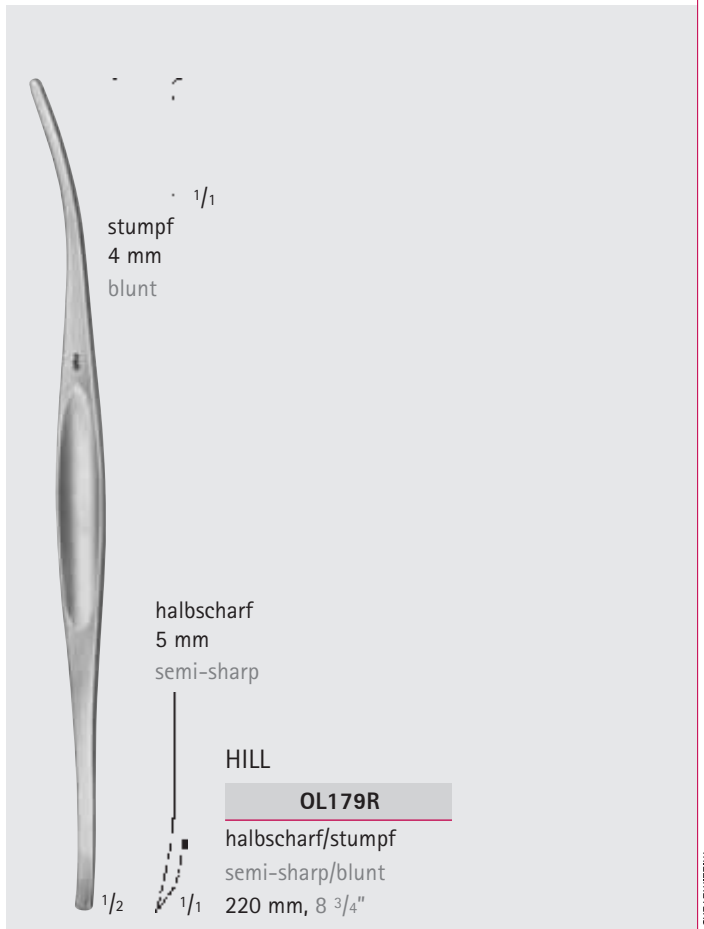
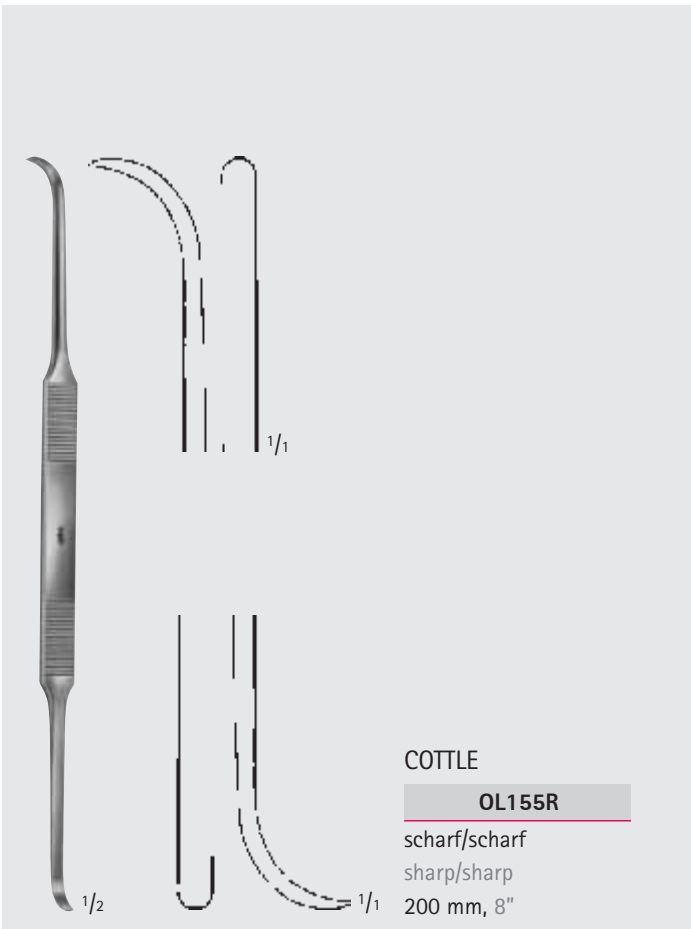
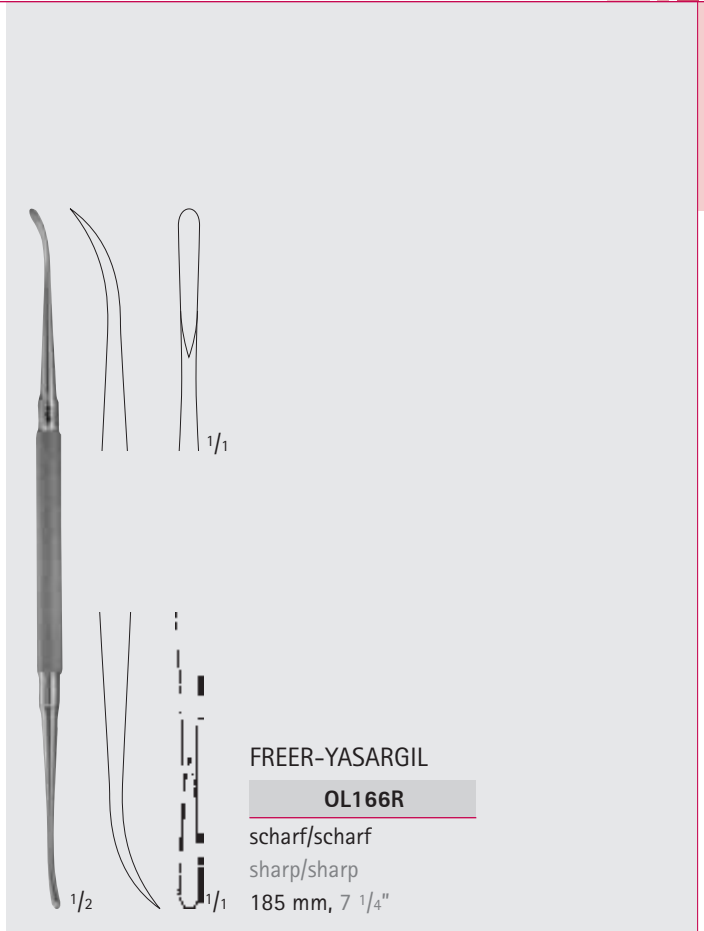
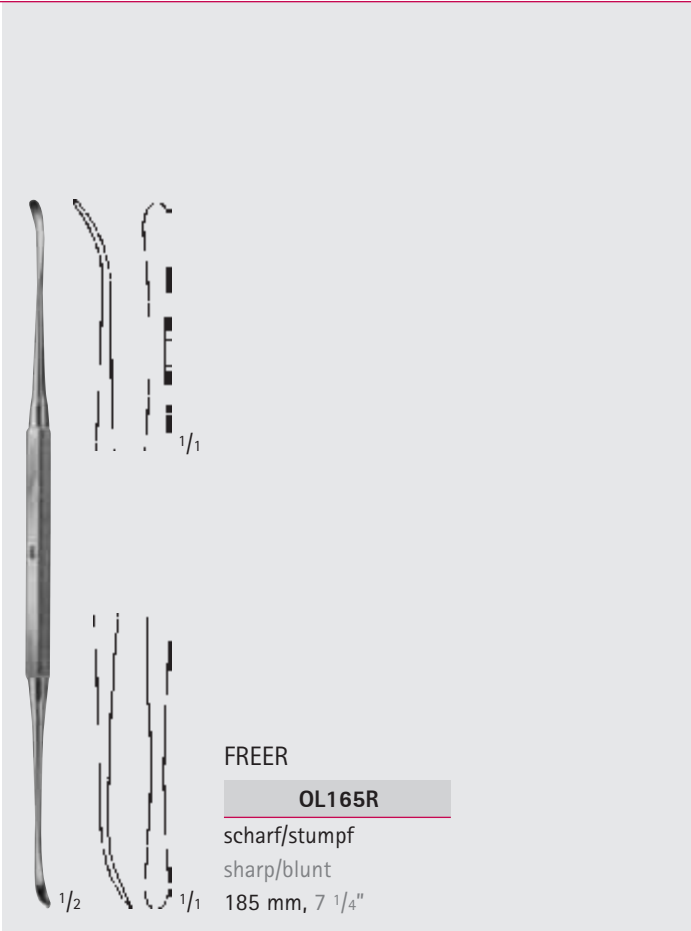

MILLIMETERS

# Knochenheber, Raspatorien, Scharfe Löffel – Bone Levers, Elevators, Bone Curettes

Raspatorien

Raspatories

FK



MEAD

**DO520R**

scharf/scharf  
sharp/sharp  
165 mm, 6 1/4"



MOLT

**DO543R**

scharf/scharf  
sharp/sharp  
180 mm, 7"



SYME

**DO547R**

scharf  
sharp  
185 mm, 7 1/4"

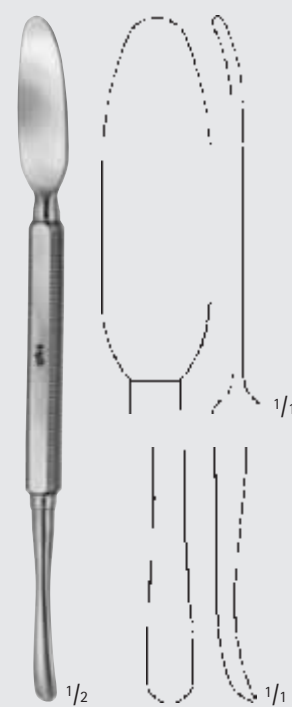

ROBERTS

**DO548R**

stumpf  
blunt  
185 mm, 7 1/4"

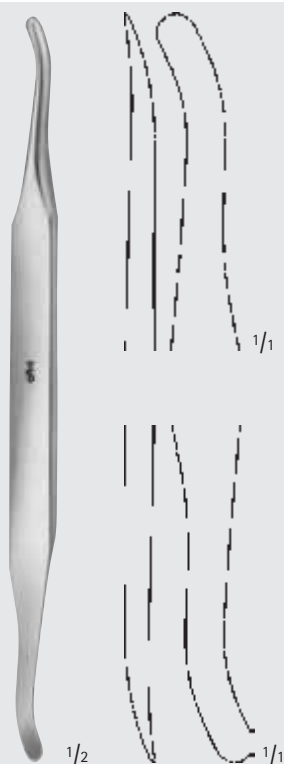

SELDIN

**DO552R**

195 mm, 7 3/4"



SELDIN

**DO553R**

195 mm, 7 3/4"



# Knochenheber, Raspatorien, Scharfe Löffel – Bone Levers, Elevators, Bone Curettes

Raspatorien  
Raspatories

FK



**FK530R**

4 mm

**FK532R**

7 mm

**FK534R**

9 mm



**FK541R**

3 mm

**FK542R**

6 mm

**FK543R**

6 mm



**FK552R**

8 mm



**FK562R**

6 mm

90°



1/2

MANNERFELT, MODIF.

**FK530R-FK562R**

155 mm, 6"

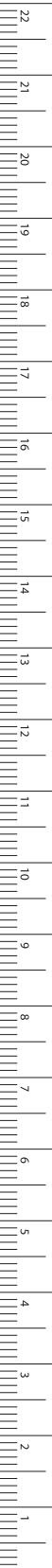

MILLIMETERS

# Knochenheber, Raspatorien, Scharfe Löffel – Bone Levers, Elevators, Bone Curettes

Raspatorien

Raspatories

FK

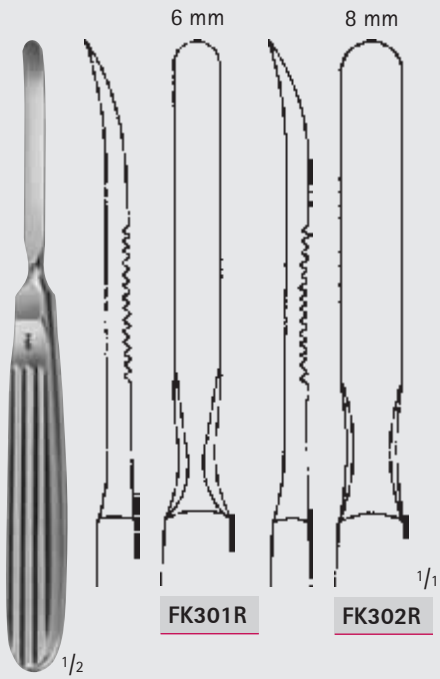
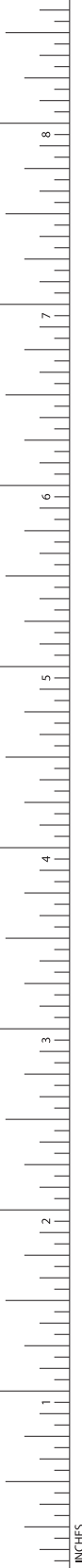

FK301R

FK302R

FK301R-FK302R

165 mm, 6 1/2"

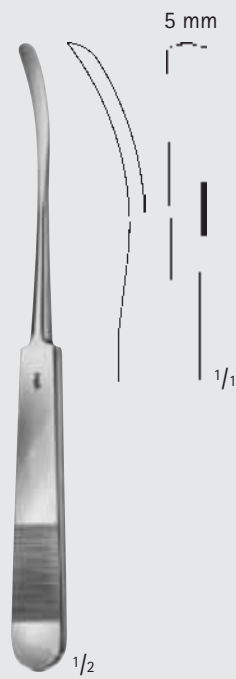

ADSON

FK299R

165 mm, 6 1/2"

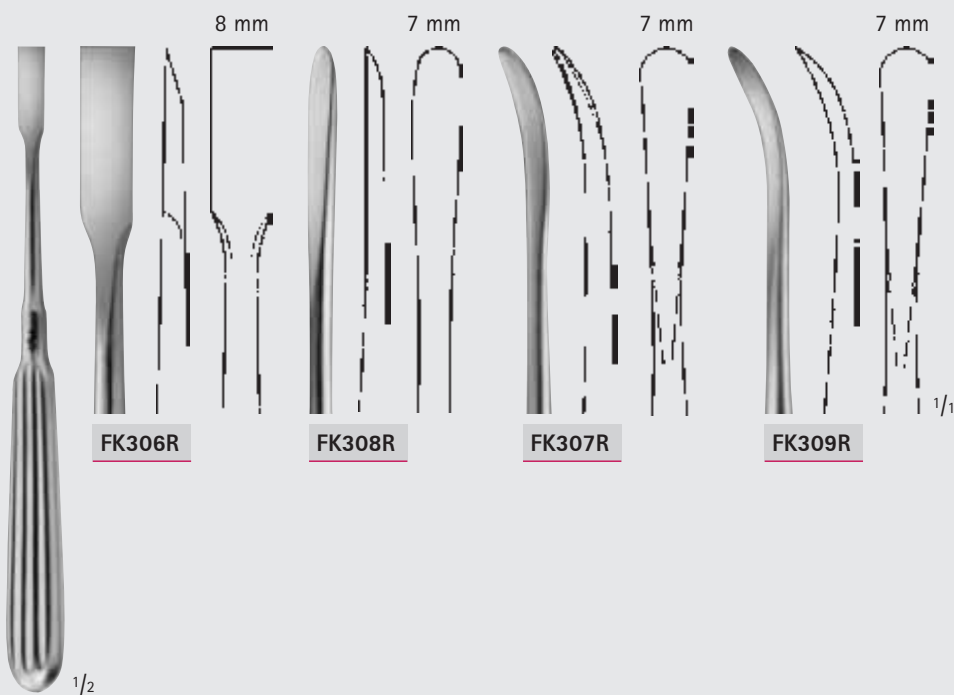

FK306R

FK308R

FK307R

FK309R

ADSON

FK306R-FK309R

170 mm, 6 3/4"



# Knochenheber, Raspatorien, Scharfe Löffel – Bone Levers, Elevators, Bone Curettes

Raspatorien  
Raspatories

FK

4 mm

4 mm

4 mm

4 mm

FK394R

FK395R

FK396R

FK397R

1/2

MÜHLING

FK394R-FK397R

170 mm, 6 3/4"

8 mm

1/1

1/2

COTTLE

OL157R

195 mm, 7 3/4"

4,7 mm

1/1

1/2

LANDOLT

FK314R

175 mm, 7"

6,2 mm

1/1

1/2

CASPAR

FK328R

180 mm, 7"

6,2 mm

1/1

1/2

CASPAR

FK329R

180 mm, 7"

6 mm

1/1

1/2

D0523R

170 mm, 6 3/4"



# Knochenheber, Raspatorien, Scharfe Löffel – Bone Levers, Elevators, Bone Curettes

Raspatorien mit PEEK-Griff

Raspatories with PEEK-Handle

Dampfsterilisierbar bis 143°C (3 bar)

Can be sterilized in a steam sterilizer up to 143°C (3 bar)

FK



6 mm

1/2

**FK318R**

190 mm, 7 1/2"

3 mm

1/2

**FK317R**

185 mm, 7 1/4"

6 mm

1/2

**FK319R**

190 mm, 7 1/2"

6 mm

1/2

**FK321R**

190 mm, 7 1/2"

13 mm

1/2

**FK323R**

175 mm, 7"

14 mm

1/2

**FK324R**

190 mm, 7 1/2"

14 mm

1/2

**FK325R**

180 mm, 7"



# Knochenheber, Raspatorien, Scharfe Löffel – Bone Levers, Elevators, Bone Curettes

Raspatorien  
Raspatories

FK

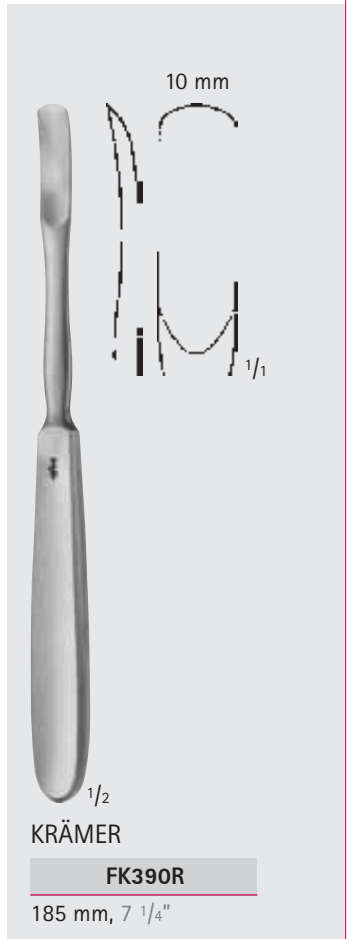
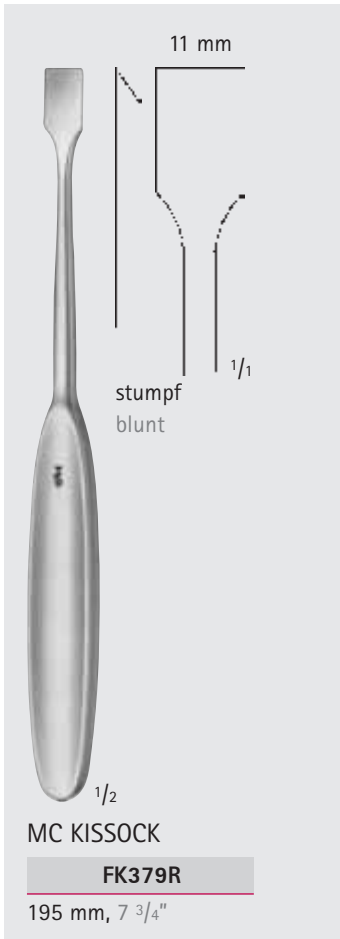
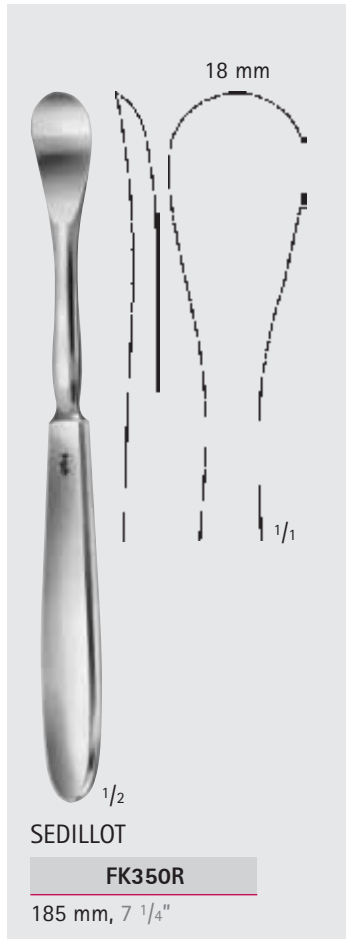
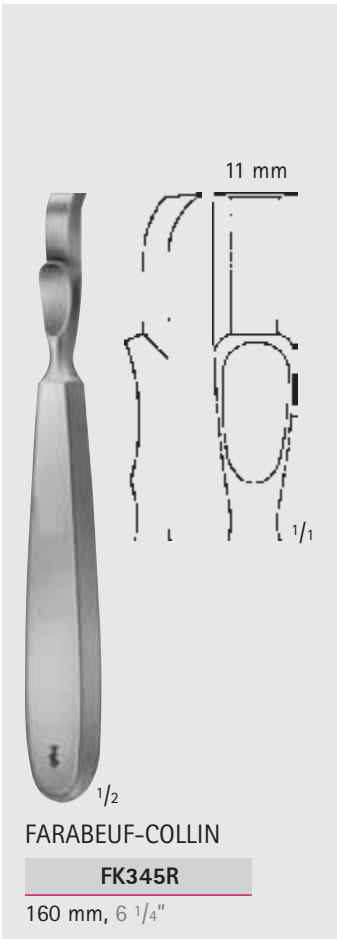
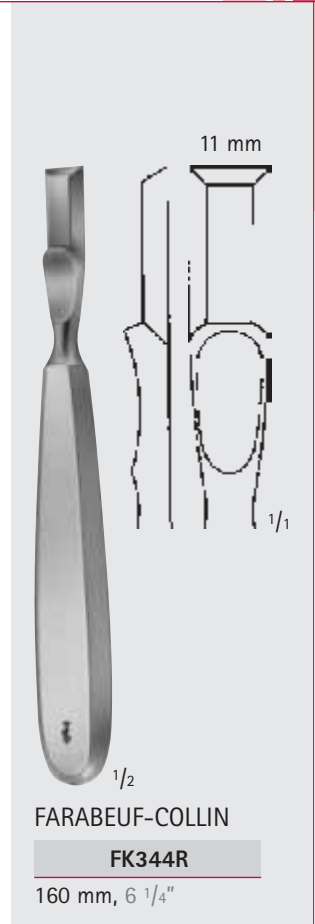
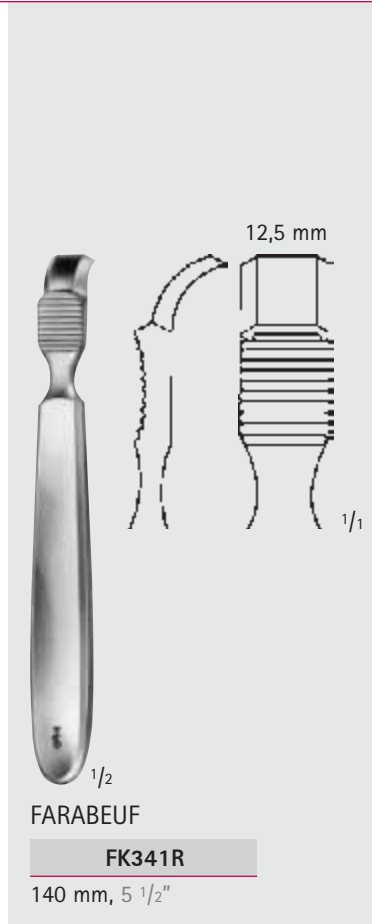
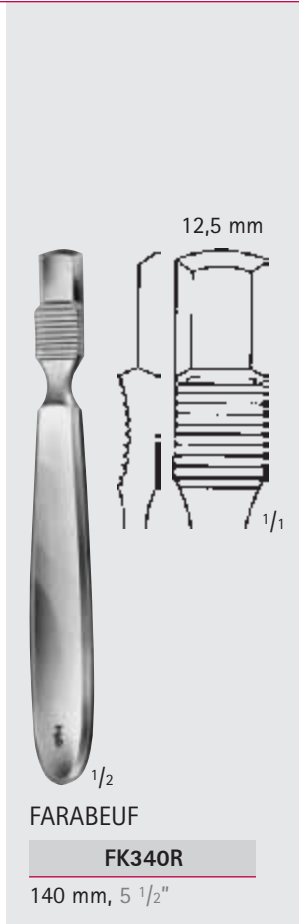
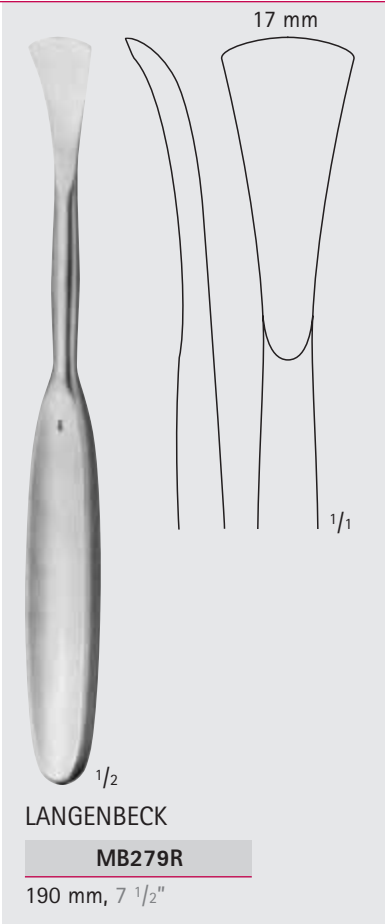

MILLIMETERS

# Knochenheber, Raspatorien, Scharfe Löffel – Bone Levers, Elevators, Bone Curettes

Raspatorien  
Raspatories

FK

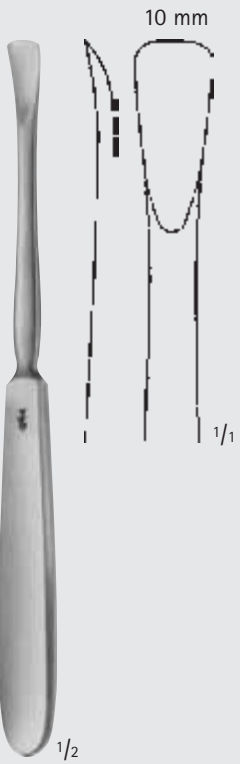

KRÄMER

**FK391R**

190 mm, 7 1/2"

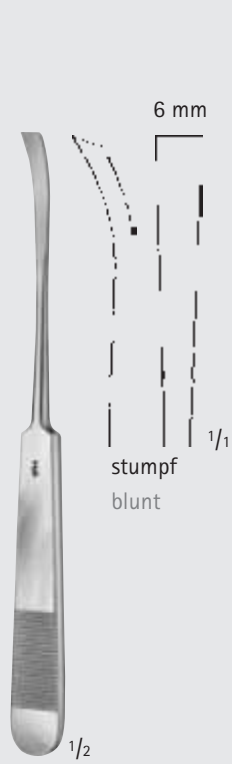

PENNYBAKER

**FK378R**

165 mm, 6 1/2"

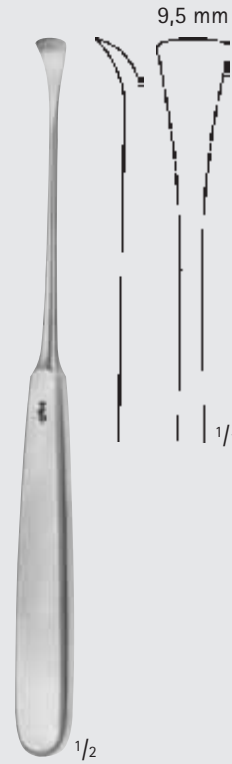

BÜCHS

**D0518R**

190 mm, 7 1/2"

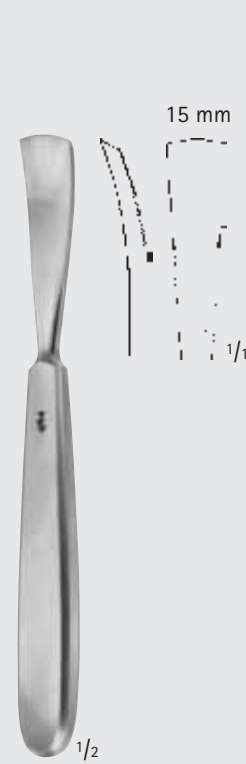

JANSEN

**FK362R**

165 mm, 6 1/2"

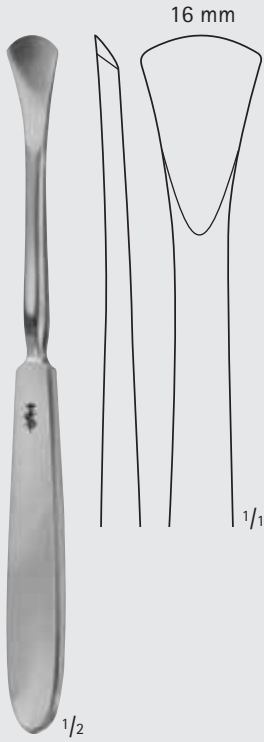

LANGENBECK

**FK360R**

190 mm, 7 1/2"

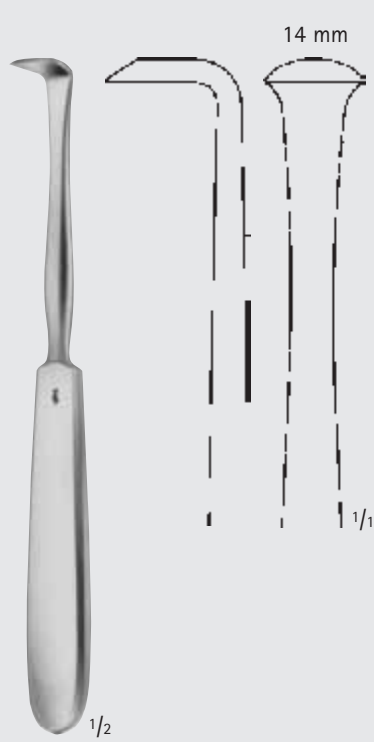

LANGENBECK

**FK361R**

180 mm, 7"



KEY

**FK410R-FK414R**

	Breite Width	Länge Length	
<b>FK410R</b>	6 mm	180 mm	7"
<b>FK411R</b>	10 mm	190 mm	7 1/2"
<b>FK412R</b>	13 mm	190 mm	7 1/2"
<b>FK413R</b>	19 mm	200 mm	8"
<b>FK414R</b>	25 mm	210 mm	8 1/4"





# Knochenheber, Raspatorien, Scharfe Löffel – Bone Levers, Elevators, Bone Curettes

Raspatorien  
Raspatories

FK

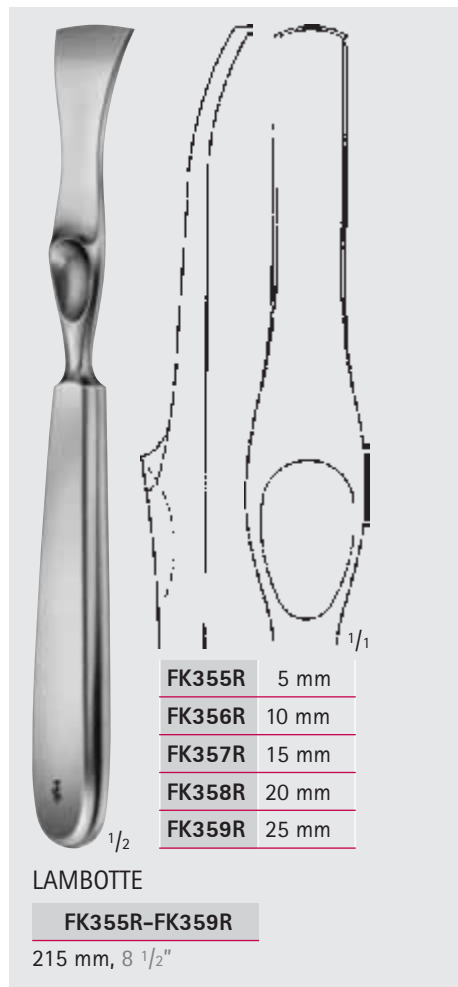
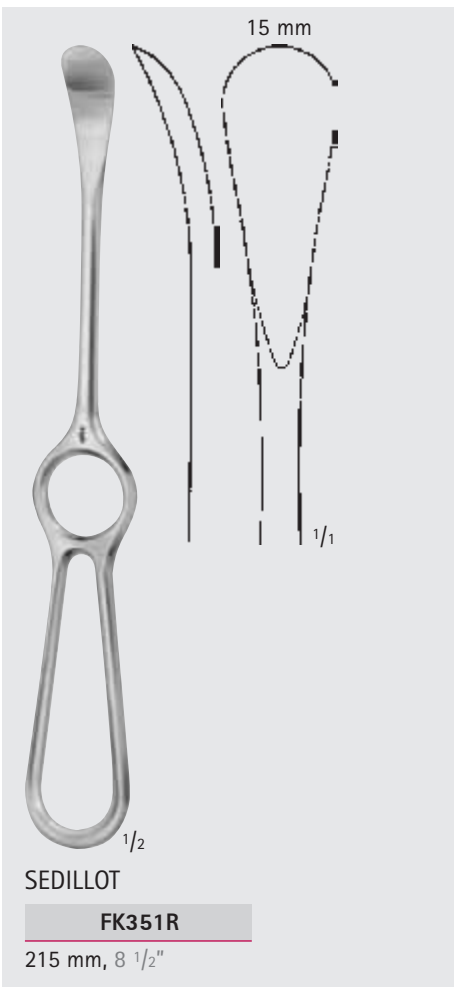
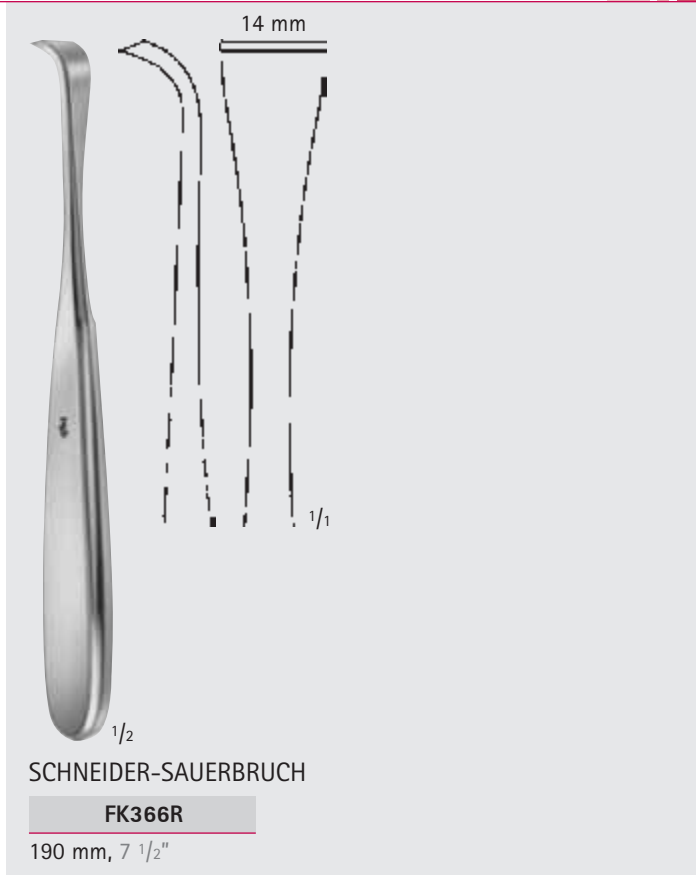
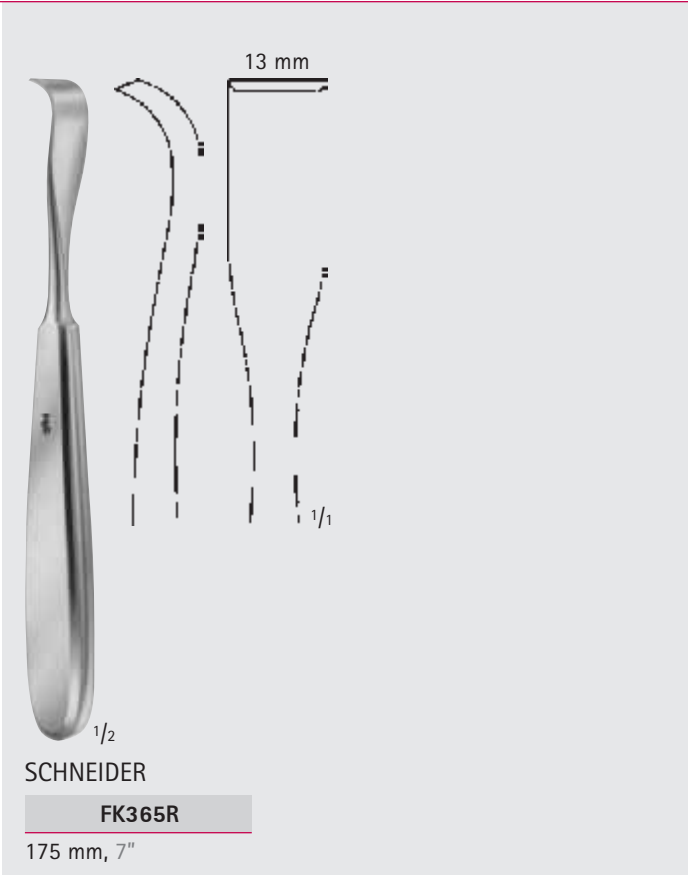

MILLIMETERS

**Knochenheber, Raspatorien, Scharfe Löffel – Bone Levers, Elevators, Bone Curettes**

Raspatorien

Raspatories

**FK**



**FK146R**

**FK147R**

**FK148R**

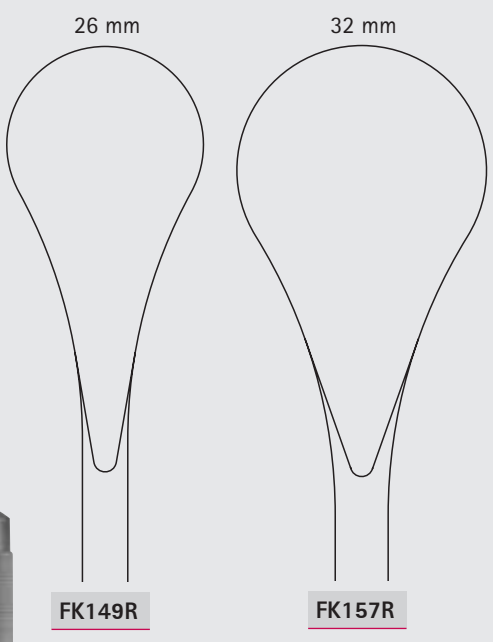

**FK149R**

**FK157R**



**COBB**  
**FK146R-FK157R**

280 mm, 11"

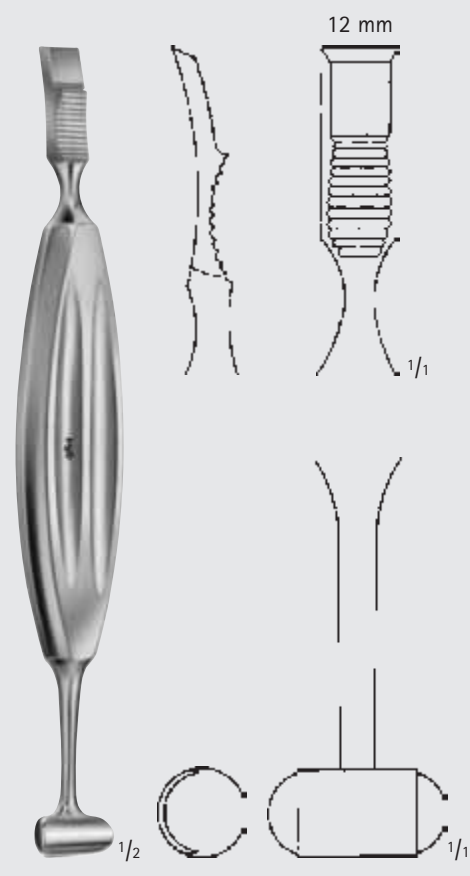

**ALEXANDER**  
**FK420R**

210 mm, 8 1/4"





# Knochenheber, Raspatorien, Scharfe Löffel – Bone Levers, Elevators, Bone Curettes

Raspatorien  
Raspatories

FK

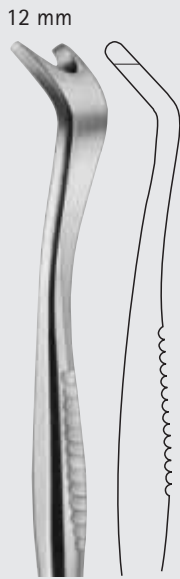
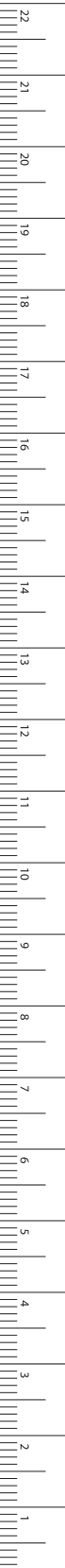

**FK381R**

190 mm

7 1/2"

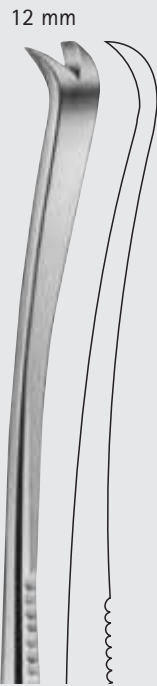

**FK382R**

230 mm

9"



**FK383R**

230 mm

9"



**FK384R**

230 mm

9"



**FK387R**

230 mm

9"

SEMB

**FK381R-FK387R**

# Knochenheber, Raspatorien, Scharfe Löffel – Bone Levers, Elevators, Bone Curettes

Raspatorien  
Raspatories

FK



FK400R

FK401R



DOYEN

**FK400R-FK401R**

für Kinder  
for children

1/2 175 mm, 7"



FK402R

FK403R



DOYEN

**FK402R-FK403R**

für Erwachsene  
for adults

1/2 175 mm, 7"



FK408R

FK409R

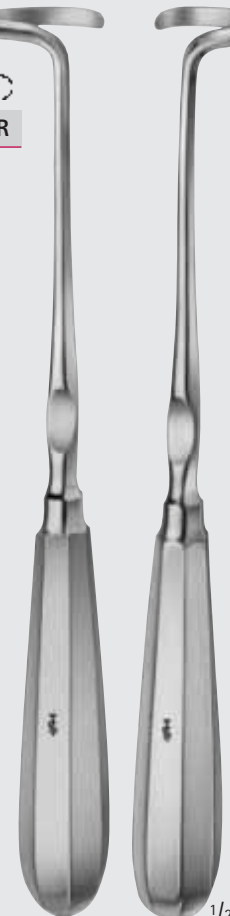

DOYEN

**FK408R-FK409R**

1/2 240 mm, 9 1/2"



## Knochenheber, Raspatorien, Scharfe Löffel – Bone Levers, Elevators, Bone Currettes

Raspatorien mit PEEK-Griff  
Raspatories with PEEK Handle

Dampfsterilisierbar bis 143°C

Can be sterilized in a steam sterilizer up to 143°C (3 bar)

FK

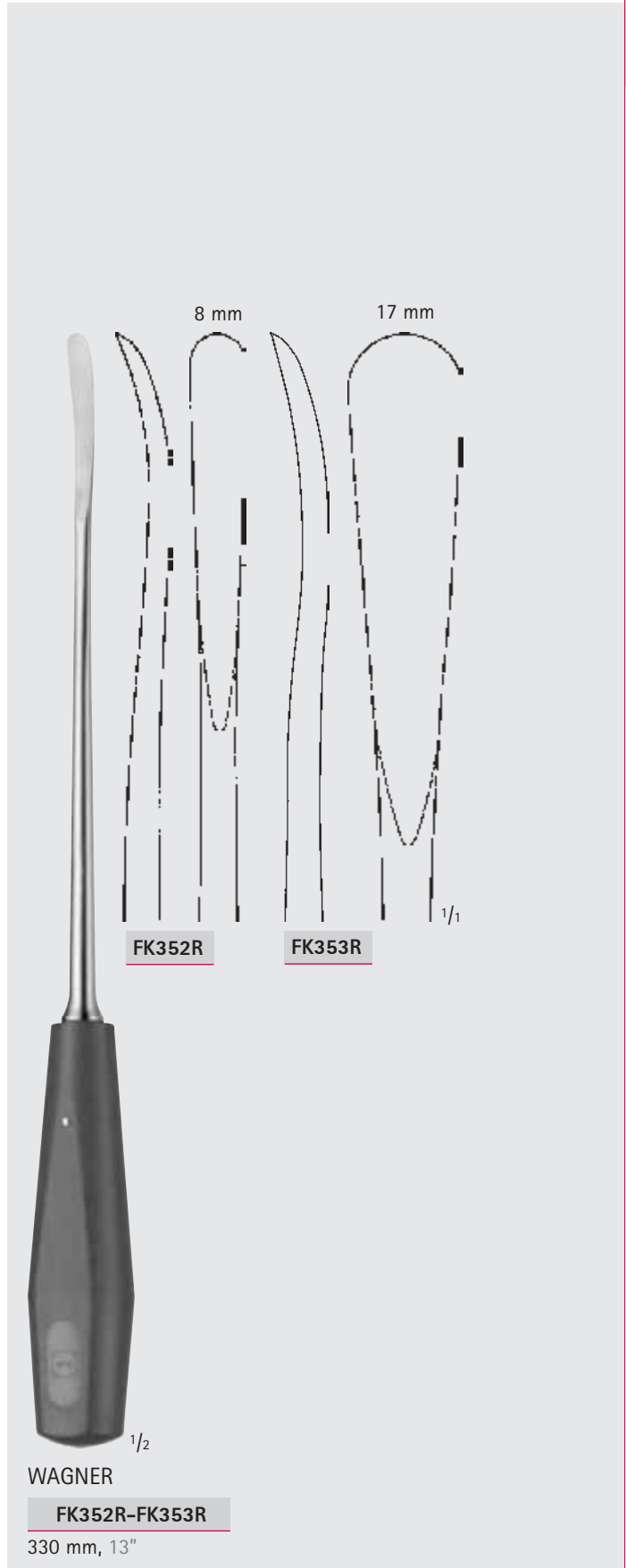
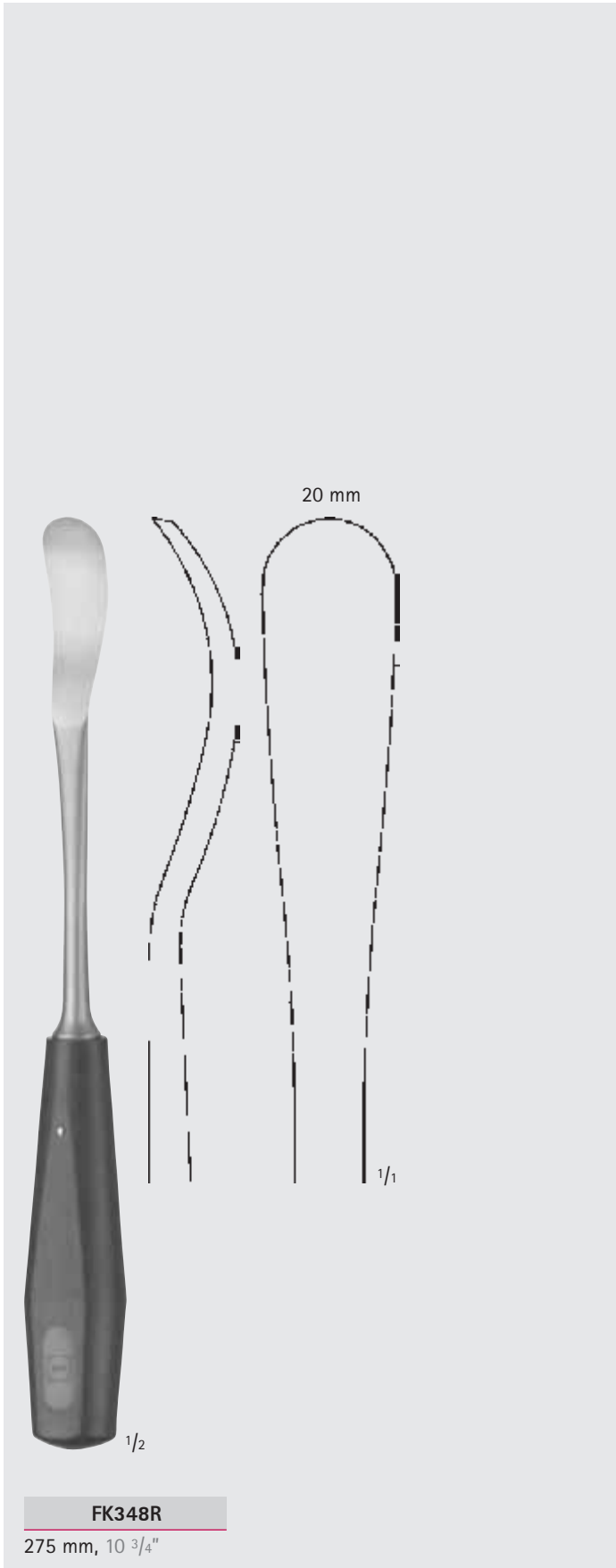

# Knochenheber, Raspatorien, Scharfe Löffel – Bone Levers, Elevators, Bone Curettes

Knochen-Feilen und -Raspeln

Bone Files and Rasps

FK



7,5 mm

9 mm



**OL401R**

kariert, fein  
fine, chequered

**OL403R**

kariert, grob  
coarse, chequered

JOSEPH

**OL401R-OL403R**

165 mm, 6 1/2"

1/2

8 mm

8 mm



**OL408R**

feine Zahnung  
fine teeth

**OL409R**

grobe Zahnung  
coarse teeth

LEWIS

**OL408R-OL409R**

175 mm, 7"

1/2

9 mm



**OL407R**

auf Zug  
down stroke

MALTZ

**OL407R**

180 mm, 7"

1/2

9 mm

9 mm



**OL410R**

auf Druck  
up stroke

**OL411R**

auf Zug  
down stroke

AUFRIECHT

**OL410R-OL411R**

220 mm, 8 3/4"

1/2

6,5 mm

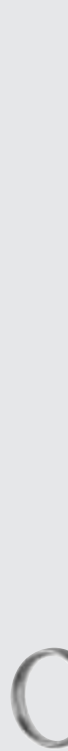

**OL412R**

auf Zug  
down stroke

GALLAHER

**OL412R**

190 mm, 7 1/2"

1/2



# Knochenheber, Raspatorien, Scharfe Löffel – Bone Levers, Elevators, Bone Curettes

Knochen-Feilen und -Raspeln, DUROGRIP® Raspeln

Bone Files and Rasps, DUROGRIP® Rasps

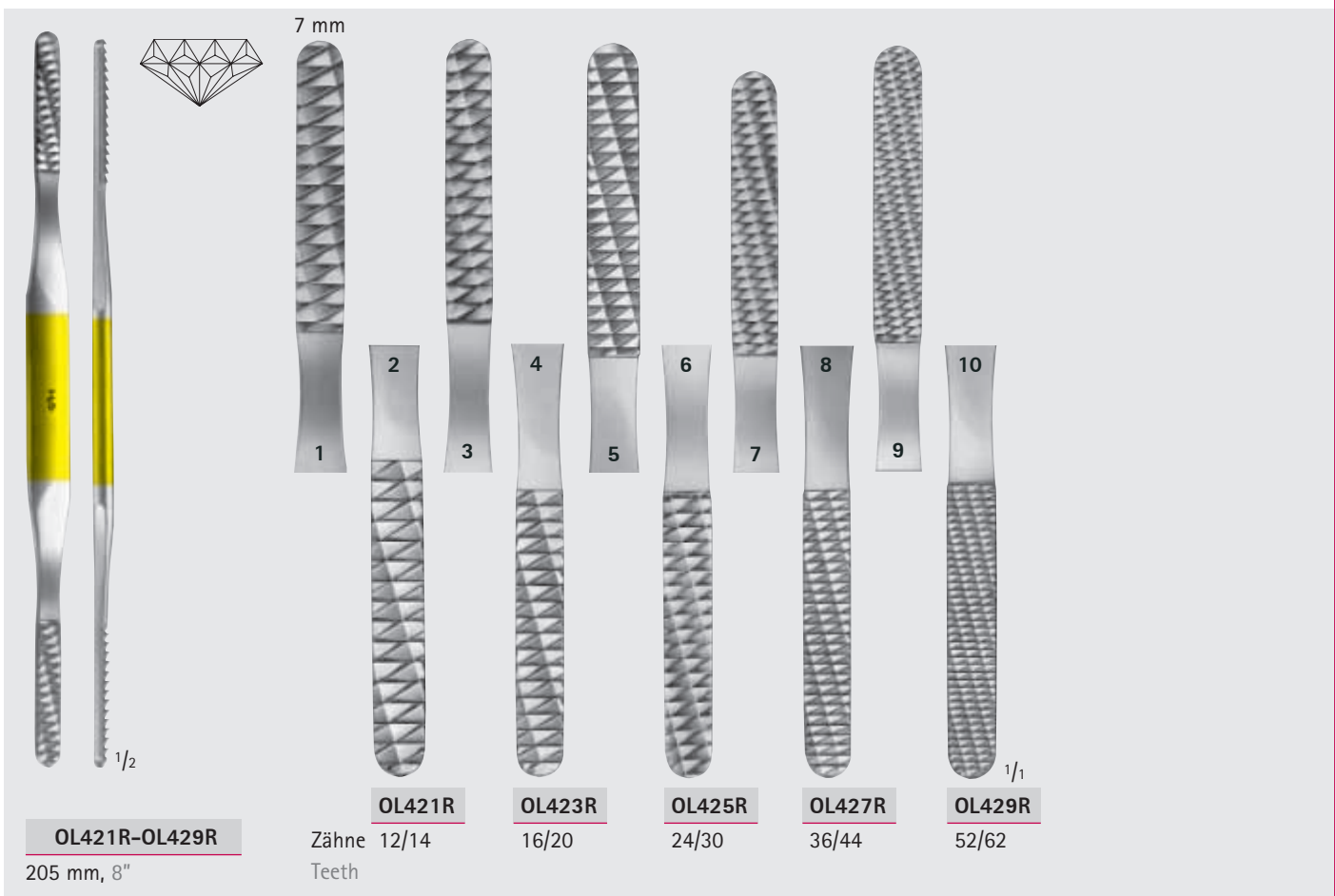
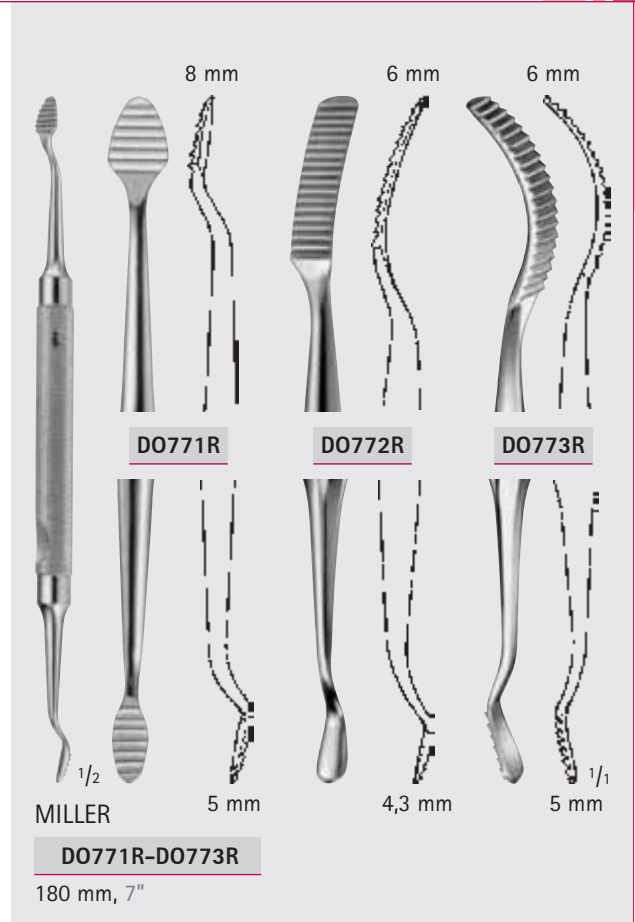
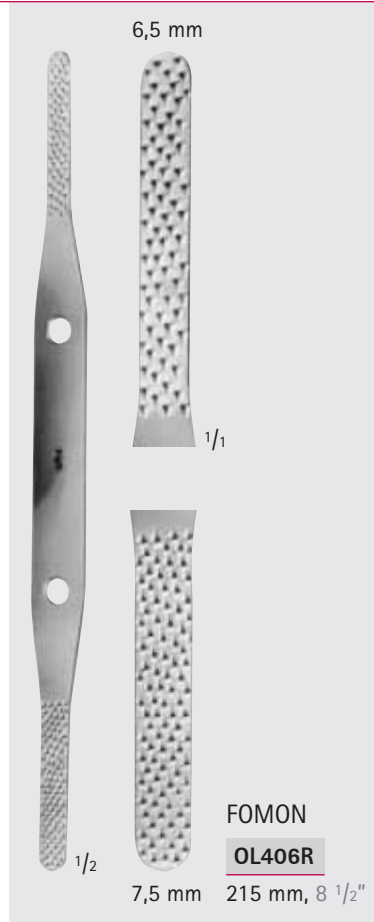
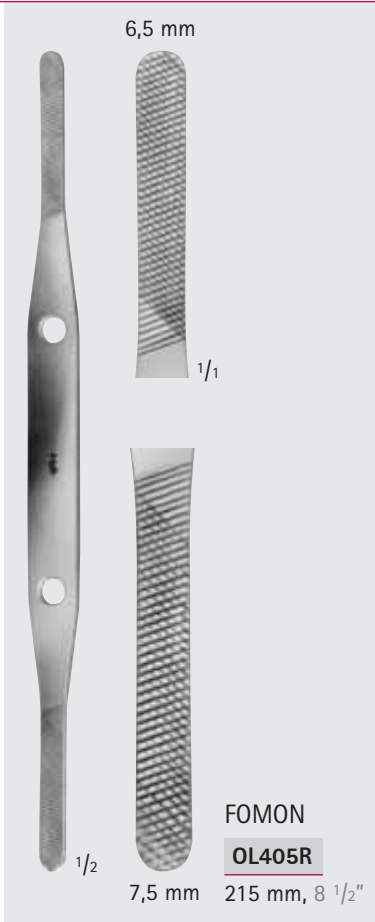

**FK**

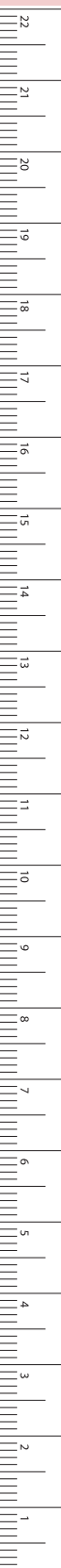

MILLIMETERS

# Knochenheber, Raspatorien, Scharfe Löffel – Bone Levers, Elevators, Bone Curettes

Knochen-Feilen und -Raspeln

Bone Files and Rasps

FK



20 mm



eine Seite Feilenhieb,  
andere Seite Raspelhieb  
one side file cut one  
side rasp cut

1/2

**FK507R**

220 mm, 8 3/4"

20 mm



1/2

**FK510R**

295 mm, 11 3/4"

13 mm

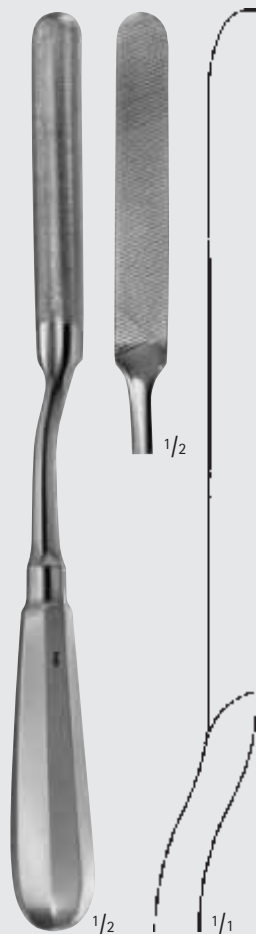

1/2

1/1

**FK511R**

240 mm, 9 1/2"

18 mm



1/2

1/1

20 mm

PUTTI

**FK505R**

270 mm, 10 3/4"





# Knochenheber, Raspatorien, Scharfe Löffel – Bone Levers, Elevators, Bone Curettes

Scharfe Löffel  
Bone Curettes

**FK**



JACOBSON

**FK813R**

140 mm, 5 1/2"



MARTINI

**FK800R**

140 mm, 5 1/2"



MARTINI

**FK801R**

140 mm, 5 1/2"



WILLIGER

**FK814R**

145 mm, 5 3/4"



JANSEN

**FK803R**

160 mm, 6 1/4"



BARTH

**FK817R**

180 mm, 7"



**FK850R**

210 mm, 8 1/4"

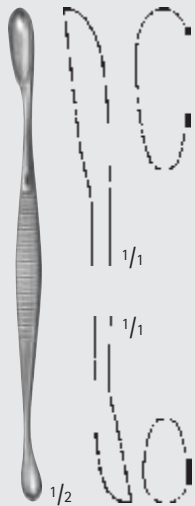

VOLKMANN

**FK840R**

130 mm, 5 1/8"

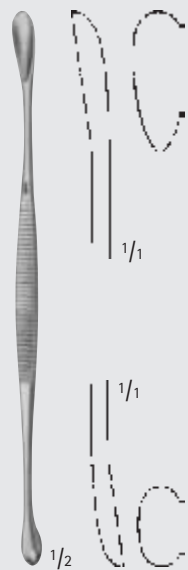

VOLKMANN

**FK841R**

145 mm, 5 3/4"

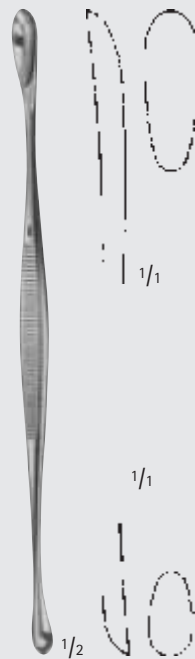

VOLKMANN

**FK842R**

170 mm, 6 3/4"

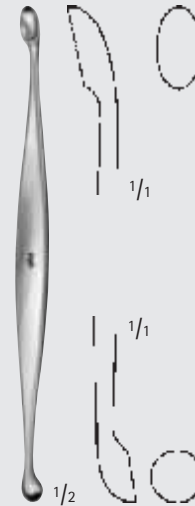

**FK845R**

130 mm, 5 1/8"

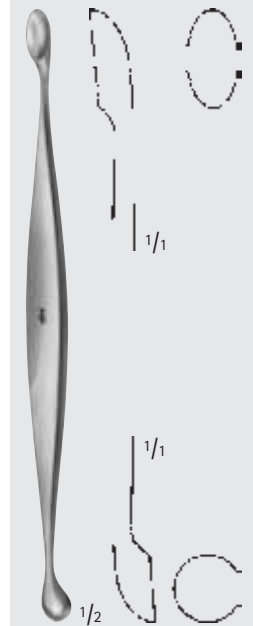

**FK846R**

160 mm, 6 1/4"

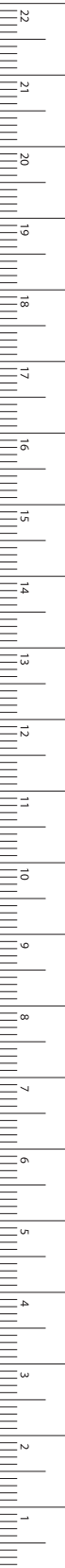

MILLIMETERS

# Knochenheber, Raspatorien, Scharfe Löffel – Bone Levers, Elevators, Bone Curettes

Scharfe Löffel  
Bone Curettes

FK

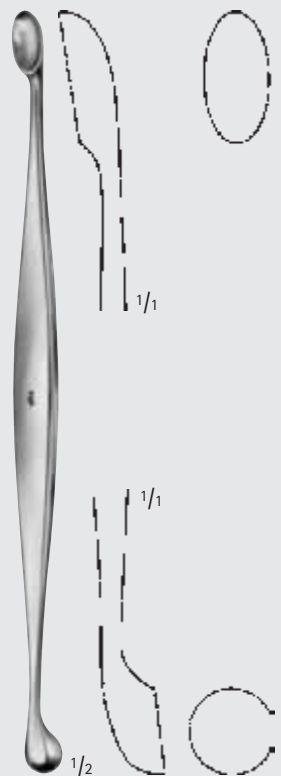

**FK848R**

200 mm, 8"



**DO650R**

160 mm, 6 1/4"



JANSEN

**DO651R**

160 mm, 6 1/4"

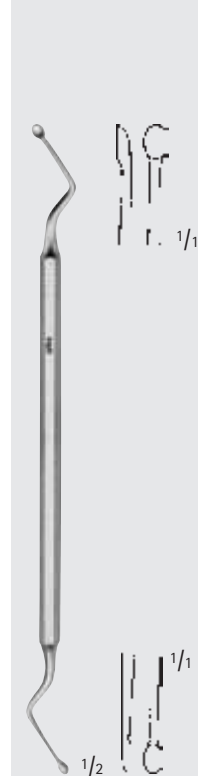

HEMINGWAY

**DO655R**

170 mm, 6 3/4"

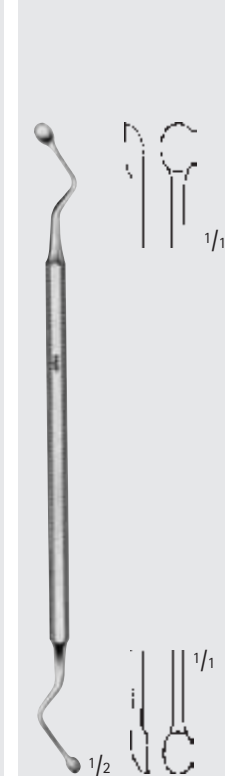

HEMINGWAY

**DO656R**

170 mm, 6 3/4"



HEMINGWAY

**DO670R**

Fig. 0  
170 mm, 6 3/4"



HEMINGWAY

**DO671R**

Fig. 1  
170 mm, 6 3/4"



HEMINGWAY

**DO672R**

Fig. 2  
170 mm, 6 3/4"



HEMINGWAY

**DO673R**

Fig. 3  
170 mm, 6 3/4"

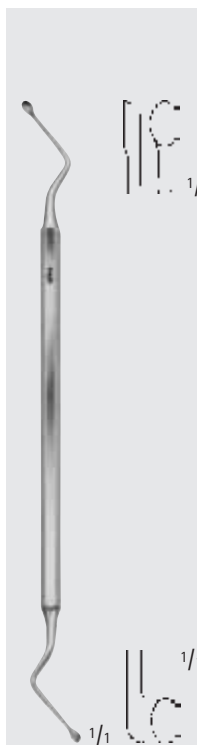

HEMINGWAY

**DO674R**

Fig. 4  
170 mm, 6 3/4"

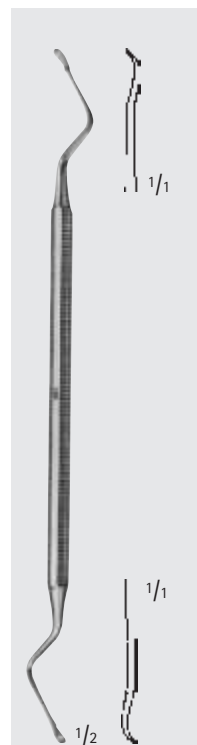

LUCAS

**DO608R**

180 mm, 7"

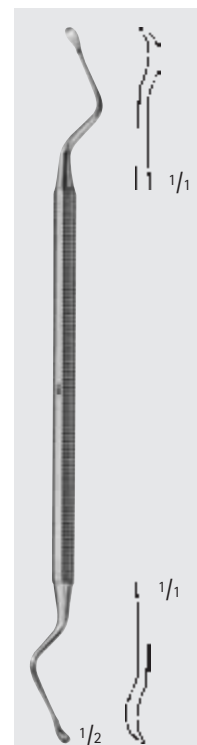

LUCAS

**DO609R**

185 mm, 7 1/4"



# Knochenheber, Raspatorien, Scharfe Löffel – Bone Levers, Elevators, Bone Curettes

Scharfe Löffel  
Bone Curettes

FK



DO630R

DO632R

1/2

KERPEL

DO630R-DO632R

145 mm, 5 3/4"



DO631R

DO633R

1/2

KERPEL

DO631R-DO633R

145 mm, 5 3/4"

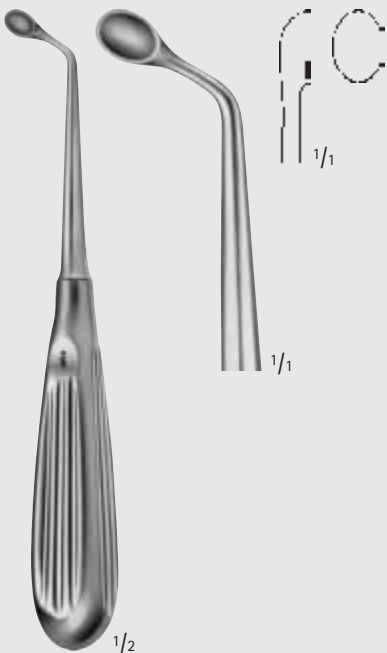

1/2

UFFENORDE

FK660R

170 mm, 6 3/4"

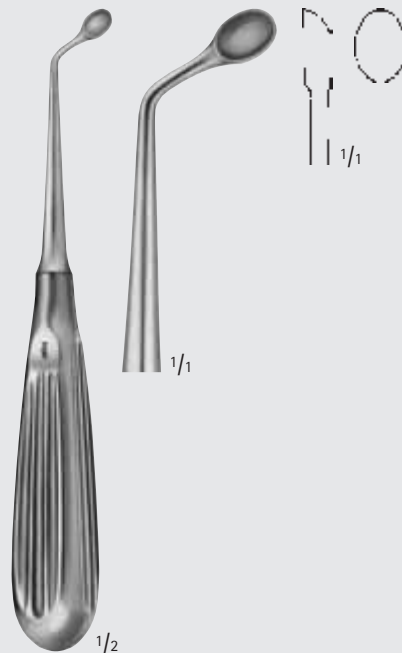

1/2

UFFENORDE

FK661R

170 mm, 6 3/4"

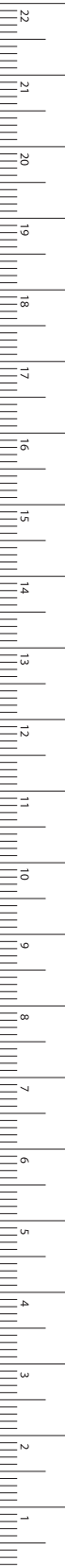

MILLIMETERS

# Knochenhebel, Raspatorien, Scharfe Löffel – Bone Levers, Elevators, Bone Curettes

## Scharfe Löffel

### Bone Curettes

FK

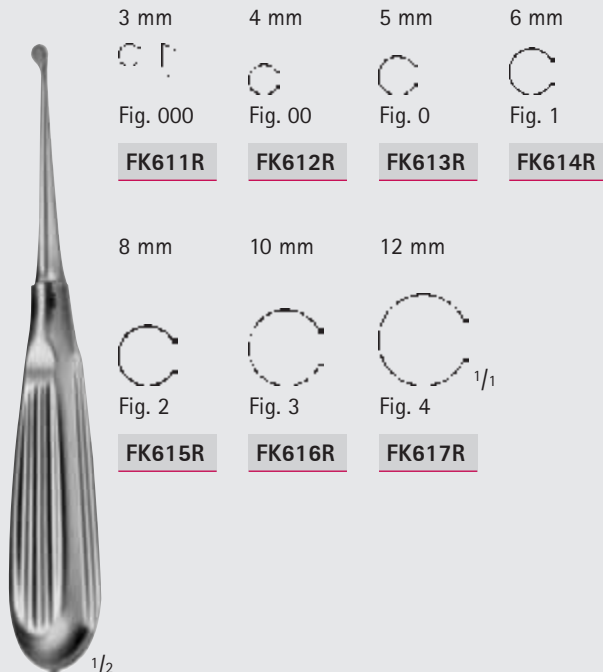

BRUNS

**FK611R-FK617R**

165 mm, 6 1/2"

3 mm      4 mm      5 mm      6 mm

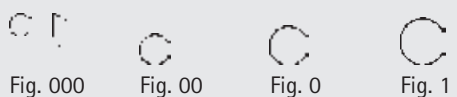

Fig. 000      Fig. 00      Fig. 0      Fig. 1

**FK611R**      **FK612R**      **FK613R**      **FK614R**

8 mm      10 mm      12 mm



Fig. 2      Fig. 3      Fig. 4 1/1

**FK615R**      **FK616R**      **FK617R**

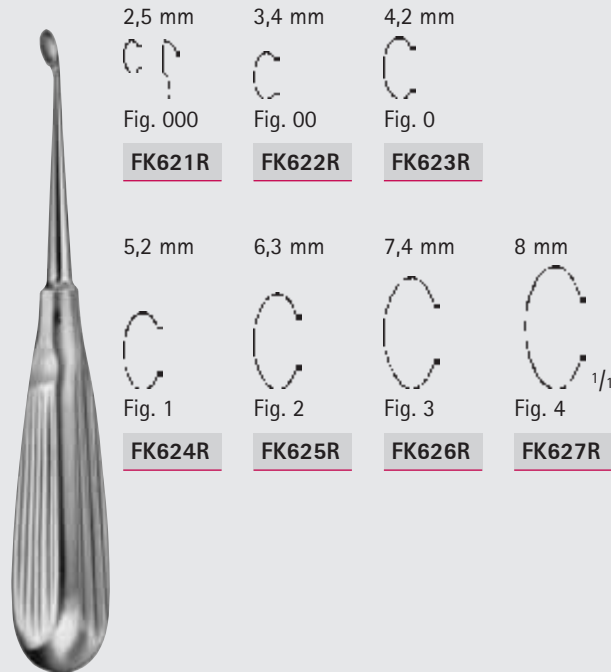

SCHEDE

**FK621R-FK627R**

170 mm, 6 3/4"

2,5 mm      3,4 mm      4,2 mm



Fig. 000      Fig. 00      Fig. 0

**FK621R**      **FK622R**      **FK623R**

5,2 mm      6,3 mm      7,4 mm      8 mm



Fig. 1      Fig. 2      Fig. 3      Fig. 4 1/1

**FK624R**      **FK625R**      **FK626R**      **FK627R**

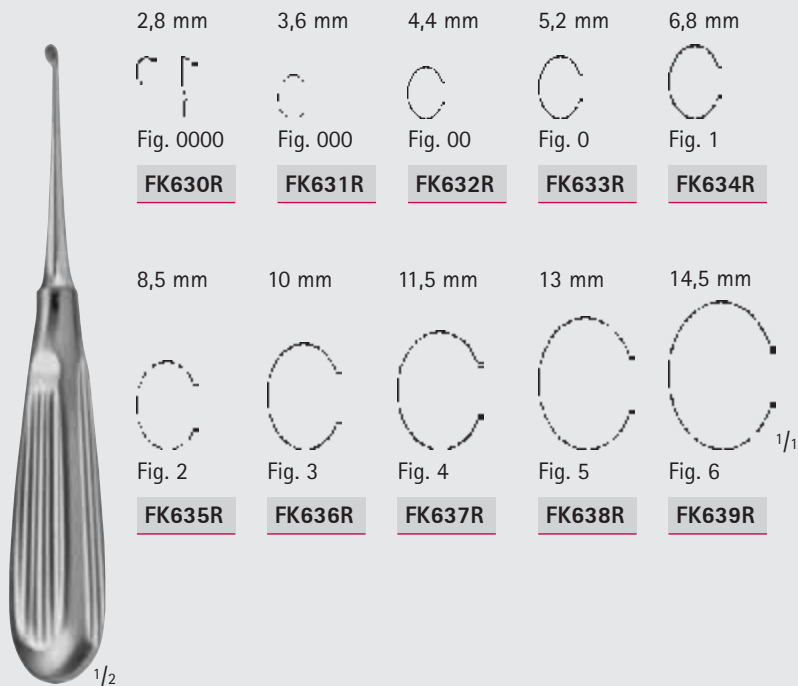

VOLKMANN

**FK630R-FK639R**

170 mm, 6 3/4"

2,8 mm      3,6 mm      4,4 mm      5,2 mm      6,8 mm



Fig. 0000      Fig. 000      Fig. 00      Fig. 0      Fig. 1

**FK630R**      **FK631R**      **FK632R**      **FK633R**      **FK634R**

8,5 mm      10 mm      11,5 mm      13 mm      14,5 mm



Fig. 2      Fig. 3      Fig. 4      Fig. 5      Fig. 6 1/1

**FK635R**      **FK636R**      **FK637R**      **FK638R**      **FK639R**

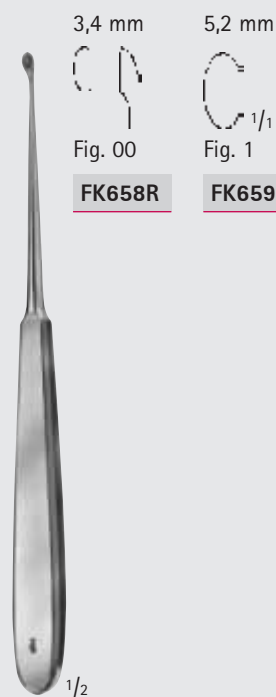

WILLIGER

**FK658R-FK659R**

170 mm, 6 3/4"

3,4 mm      5,2 mm



Fig. 00      Fig. 1 1/1

**FK658R**      **FK659R**

# Knochenheber, Raspatorien, Scharfe Löffel – Bone Levers, Elevators, Bone Curettes

Scharfe Löffel  
Bone Curettes

**FK**

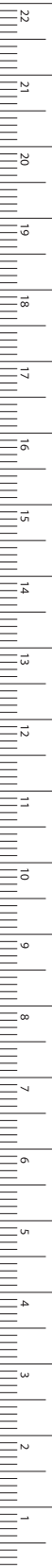

LEMPERT

**FK675R-FK679R**

215 mm, 8 1/2"



HALLE

**FK684R-FK686R**

215 mm, 8 1/2"



DAUBENSPECK

**FK662R-FK665R**

200 mm, 8"

# Knochenheber, Raspatorien, Scharfe Löffel – Bone Levers, Elevators, Bone Curettes

Scharfe Löffel  
Bone Curettes

FK

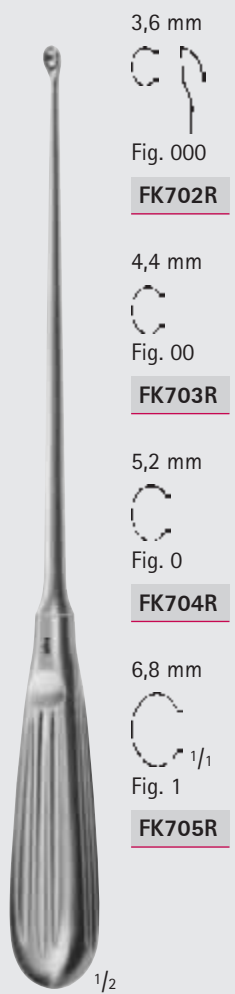

3,6 mm



Fig. 000

**FK702R**

4,4 mm



Fig. 00

**FK703R**

5,2 mm



Fig. 0

**FK704R**

6,8 mm



Fig. 1

**FK705R**

1/2

**FK702R-FK705R**

250 mm, 10"



3,6 mm



Fig. 000

**FK712R**

4,4 mm



Fig. 00

**FK713R**

5,2 mm



Fig. 0

**FK714R**

6,8 mm



Fig. 1

**FK715R**

1/2

**FK712R-FK715R**

250 mm, 10"



3 mm



Fig. 000

**FK723R**

4 mm



Fig. 00

**FK724R**

5 mm



Fig. 1/1

**FK725R**

1/2

BUSHE

**FK723R-FK725R**

250 mm, 10"



# Knochenheber, Raspatorien, Scharfe Löffel – Bone Levers, Elevators, Bone Currettes

Scharfe Löffel  
Bone Currettes

**FK**

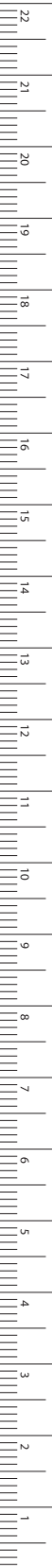

2,0 mm



Fig. 000

**MB872R**

2,5 mm



Fig. 00

**MB873R**

3,3 mm



Fig. 0

**MB874R**

3,8 mm



Fig. 1

**MB875R**

4,8 mm



Fig. 2

**MB876R**

5,3 mm



Fig. 3

**MB877R**

6,0 mm



Fig. 4

**MB878R**

6,7 mm



Fig. 5

**MB879R**

7,3 mm



Fig. 6

**MB880R**

<sup>1</sup>/<sub>2</sub>

BRUNS

**MB872R-MB880R**

230 mm, 9"

MILLIMETERS

# Knochenheber, Raspatorien, Scharfe Löffel – Bone Levers, Elevators, Bone Curettes

## Scharfe Löffel Bone Curettes

FK

3,6 mm



Fig. 000

**FK688R**

4,4 mm



Fig. 00

**FK689R**

5,2 mm



Fig. 0

**FK690R**

SIMON

**FK688R-FK690R**

1/2 235 mm, 9 1/4"

6,8 mm



Fig. 1

**ER101R**

8,5 mm



Fig. 2

**ER102R**

10 mm



Fig. 3

**ER103R**

11,5 mm



Fig. 4

**ER104R**

13 mm



Fig. 5

**ER105R**

14,5 mm



Fig. 6

**ER106R**

SIMON

**ER101R-ER106R**

1/2 max. 240 mm, 9 1/2"

3,6 mm



Fig. 000

**FK773R**

4,4 mm



Fig. 00

**FK774R**

5,2 mm



Fig. 0

**FK775R**

CASPAR

**FK773R-FK775R**

220 mm, 8 3/4"

1/2

3,6 mm



Fig. 000

**FK783R**

4,4 mm



Fig. 00

**FK784R**

5,2 mm

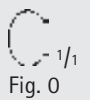

Fig. 0

**FK785R**

CASPAR

**FK783R-FK785R**

220 mm, 8 3/4"

1/2



4 mm

**FK834R**



5 mm

**FK835R**



6 mm

**FK836R**

CASPAR

**FK834R-FK836R**

gezahnt  
toothed

1/2 220 mm, 8 3/4"







# Knochenheber, Raspatorien, Scharfe Löffel – Bone Levers, Elevators, Bone Curettes

Scharfe Löffel  
Bone Curettes

Dampfsterilisierbar bis 143°C (3 bar)  
Can be sterilized in a steam sterilizer  
up to 143°C (3 bar overpressure)

FK

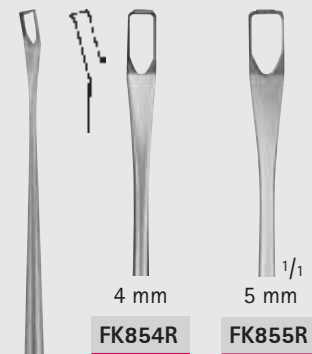
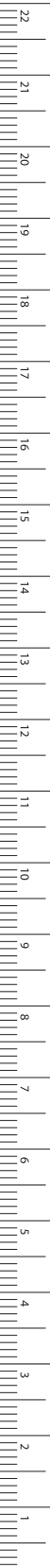

FK854R

FK855R

1/2  
CASPAR

FK854R-FK855R

gezahnt  
toothed  
250 mm, 10"

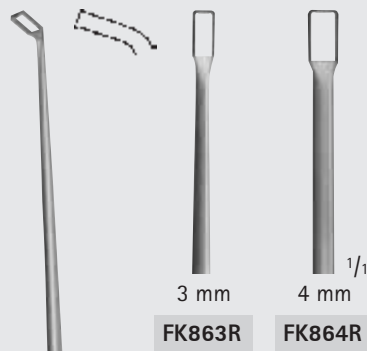

FK863R

FK864R

1/2  
CASPAR

FK863R-FK864R

gezahnt  
toothed  
270 mm, 10 3/4"



4,4 mm

Fig. 00

FK666R

6,8 mm

Fig. 1

FK668R

8,5 mm

Fig. 2

FK670R

10 mm

Fig. 3

FK672R

1/2

FK666R-FK672R

270 mm, 10 3/4"

MILLIMETERS



INCHES

FL



Hämmer, Meißel

Mallets, Chisels and Gouges

## Hämmer und Meißel – Mallets, Chisels and Gouges

### Hämmer

### Mallets

Die Gewichtsangaben beziehen sich auf den Kopf des jeweiligen Hammers

Weights refer to the heads of the mallets



Ø 20 mm  
diam. 20 mm

#### MEAD

**FL035R** 180 g

mit auswechselbaren  
Kunststoffbacken  
with interchangeable  
plastic discs

190 mm, 7 1/2"

#### FL034

Ersatzbackenpaar  
Pair of spare discs

1/2

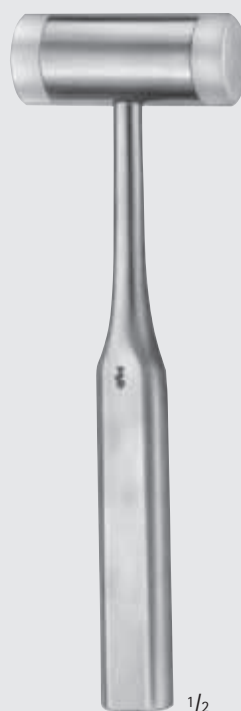

Ø 25 mm  
diam. 25 mm

**FL036R** 135 g

mit auswechselbaren  
Kunststoffbacken  
with interchangeable  
plastic discs

185 mm, 7 1/4"

#### FL037

Ersatzbackenpaar  
Pair of spare discs

1/2



Ø 30 mm  
diam. 30 mm

#### COTTLE

**FL038R** 235 g

1 Seite flach, 1 Seite convex

1 side flat, 1 side convex

185 mm, 7 1/4"

1/2



Ø 25 mm  
diam. 25 mm

**FL039R** 130 g

mit einer flachen und einer  
aufgerauhten Fläche  
with one smooth and one  
rough surface

185 mm, 7 1/4"

1/2

FL





## Hämmer und Meißel – Mallets, Chisels and Gouges

Hämmer  
Mallets

Die Gewichtsangaben beziehen sich auf den Kopf des jeweiligen Hammers  
Weights refer to the heads of the mallets

FL



Ø 22 mm  
diam. 22 mm

**DF112R** 80 g  
165 mm, 6 1/2"

1/2



Ø 22 mm  
diam. 22 mm

**DF114R** 155 g  
190 mm, 7 1/2"

1/2



Ø 27 mm  
diam. 27 mm

**HAJEK**  
**FLO44R** 135 g  
220 mm, 8 3/4"

1/2

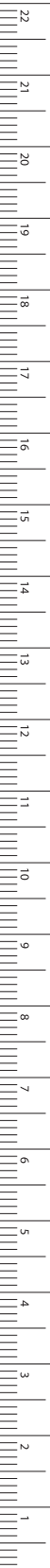

MILLIMETERS

## Hämmer und Meißel – Mallets, Chisels and Gouges

### Hämmer

### Mallets

Die Gewichtsangaben beziehen sich auf den Kopf des jeweiligen Hammers

Weights refer to the heads of the mallets

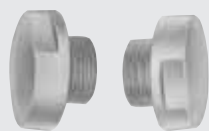

**FL047**

Ersatzbackenpaar  
Pair of spare disks

Dampfsterilisierbar bis  
143°C (3 bar)

Can be sterilized in a  
steam sterilizer up to  
143°C (3 bar)



**FL064R** 215 g

1 Metallbacke, plan  
1 Metallbacke, convex  
1 metal disc, flat  
1 metal disc, convex

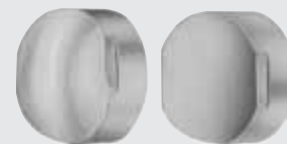

**FL065** 30 g

1 Kunststoffbacke, plan  
1 Kunststoffbacke, convex  
1 plastic disc, flat  
1 plastic disc, convex



**FL045R** 200 g

mit auswechselbaren  
Kunststoffbacken  
with interchangeable  
plastic discs  
245 mm, 9 3/4"



**FL010** 42 mm

**FL011** 50 mm  
250 mm, 10"



Hammerkopf ohne Backen 125 g  
Mallet head without disks 125 g

WAGNER

**FL062**

komplett mit:

FL064R 1 Paar Metallbacken  
FL065 1 Paar Kunststoffbacken  
1 Schlüssel

complete with:

FL064R 1 pair of metal discs  
FL065 1 pair of plastic discs  
1 wrench

235 mm, 9 1/4"



## Hämmer und Meißel – Mallets, Chisels and Gouges

Hämmer  
Mallets

Die Gewichtsangaben beziehen sich auf den Kopf des jeweiligen Hammers  
Weights refer to the heads of the mallets



**FLO70S** 425 g

Kopf aus Implantatwerkstoff  
Head made of material  
used for implants  
235 mm, 9 1/4"



**BERGMANN**

**FLO60R** 300 g

245 mm, 9 3/4"



**BERGMANN**

**FLO55R** 245 g

235 mm, 9 1/4"

FL

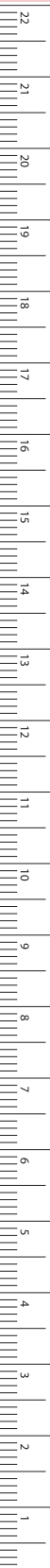

# Hämmer und Meißel – Mallets, Chisels and Gouges

## Hämmer

### Mallets

Die Gewichtsangaben beziehen sich auf den Kopf des jeweiligen Hammers

Weights refer to the heads of the mallets



**FL059R** 285 g  
240 mm, 9 1/2"



**OMBREDANNE**  
**FL066R** 520 g  
240 mm, 9 1/2"



**HEATH**  
**FL068C** 660 g 40 mm 185 mm, 7 1/4"  
**FL069C** 725 g 45 mm 200 mm, 8"

mit Kupferfüllung  
with cooper filled head

FL







# Hämmer und Meißel – Mallets, Chisels and Gouges

Stößel  
Tampers

FL

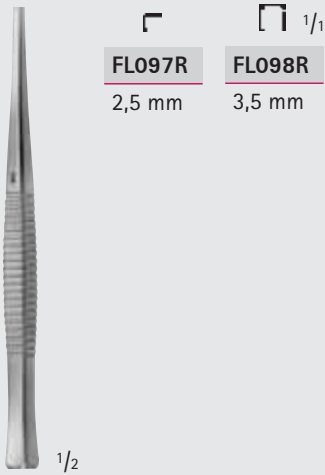

**FL097R**  
2,5 mm

**FL098R**  
3,5 mm

PASSOW

**FL097R-FL098R**

120 mm, 4 3/4"

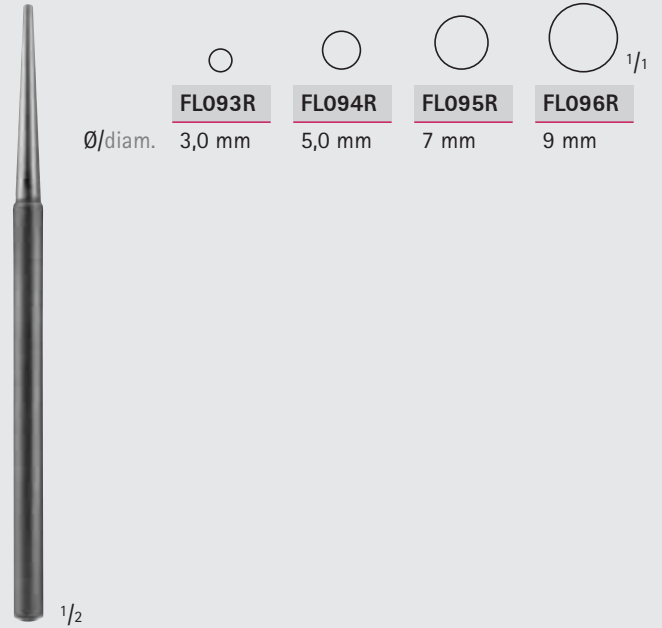

**FL093R**  
Ø/diam. 3,0 mm

**FL094R**  
5,0 mm

**FL095R**  
7 mm

**FL096R**  
9 mm

**FL093R-FL096R**

160 mm, 6 1/2"



**FF913R**  
Ø/diam. 3 mm

**FF914R**  
5 mm

**FF915R**  
8 mm

CASPAR

**FF913R-FF915R**

200 mm, 8"



**FL090R**  
Ø/diam. 12 mm

**FL091R**  
14 mm

**FL092R**  
16 mm

**FL090R-FL092R**

200 mm, 8"



MILLIMETERS

## Hämmer und Meißel – Mallets, Chisels and Gouges

Osteotome, Flach- und Hohlmeißel

Osteotomes, Chisels and Gouges

FL

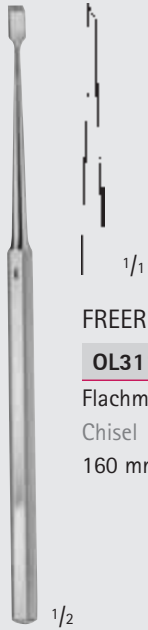

FREER

**OL311R** 4 mm

Flachmeißel

Chisel

160 mm, 6 1/4"

1/2

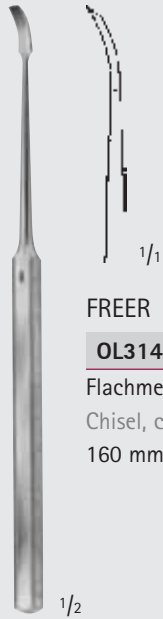

FREER

**OL314R** 4 mm

Flachmeißel, gebogen

Chisel, curved

160 mm, 6 1/4"

1/2

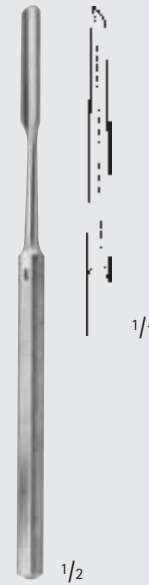

FREER

**OL316R** 6 mm

Hohlmeißel

Gouge

150 mm, 6"

1/2



MANNERFELT MODIF.

**FL144R** 4 mm

**FL146R** 6 mm

**FL148R** 8 mm

Osteotome

Osteotomes

155 mm, 6"

1/2



MANNERFELT MODIF.

**FL153R** 3 mm

Hohlmeißel

Gouge

155 mm, 6"

1/2



KRÄMER

**FL711R** 2,6 mm

Osteophyten-Meißel  
mit Griff

Chisel for osteophytes  
with handle

215 mm, 8 1/2"



1/2



## Hämmer und Meißel – Mallets, Chisels and Gouges

Osteotome, Flach- und Hohlmeißel  
Osteotomes, Chisels and Gouges

FL

<b>FL110R</b>	4 mm
<b>FL112R</b>	6 mm
<b>FL114R</b>	8 mm
<b>FL116R</b>	10 mm
<b>FL118R</b>	12 mm

Osteotome  
Osteotomes  
140 mm, 5 1/2"

<b>FL120R</b>	4 mm
<b>FL122R</b>	6 mm
<b>FL124R</b>	8 mm
<b>FL126R</b>	10 mm
<b>FL128R</b>	12 mm

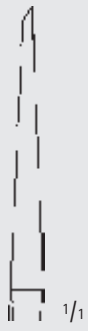
Flachmeißel  
Chisels  
140 mm, 5 1/2"

GILLIES

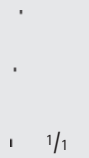
<b>OL341R</b>	5 mm
<b>OL342R</b>	7 mm
<b>OL343R</b>	9 mm

Osteotome  
Osteotomes  
140 mm, 5 1/2"

<b>FL130R</b>	4 mm
<b>FL132R</b>	6 mm
<b>FL134R</b>	8 mm
<b>FL136R</b>	10 mm
<b>FL138R</b>	12 mm

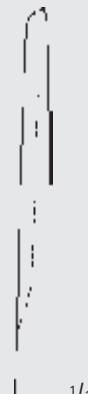
Hohlmeißel  
Gouges  
140 mm, 5 1/2"

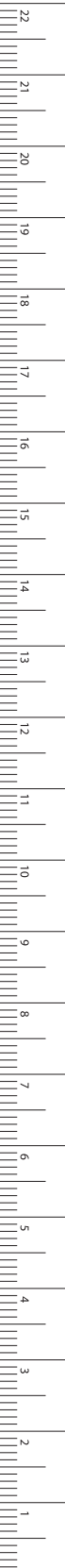

MILLIMETERS

## Hämmer und Meißel – Mallets, Chisels and Gouges

Flach- und Hohlmeißel

Chisels and Gouges

FL



PARTSCH

<b>FL173R</b>	3 mm
<b>FL174R</b>	4 mm
<b>FL175R</b>	5 mm
<b>FL176R</b>	6 mm

Flachmeißel

Chisels

140 mm, 5 1/2"

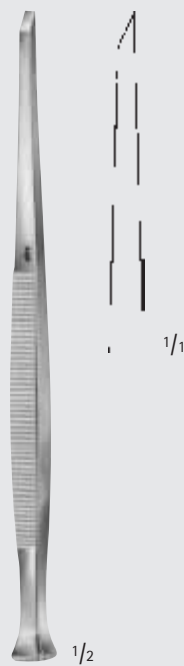

PARTSCH

<b>FL183R</b>	3 mm
<b>FL184R</b>	4 mm
<b>FL185R</b>	5 mm
<b>FL186R</b>	6 mm
<b>FL187R</b>	7 mm

Flachmeißel

Chisels

170 mm, 6 3/4"



PARTSCH

<b>FL213R</b>	3 mm
<b>FL214R</b>	4 mm
<b>FL215R</b>	5 mm
<b>FL216R</b>	6 mm

Hohlmeißel

Gouges

140 mm, 5 1/2"

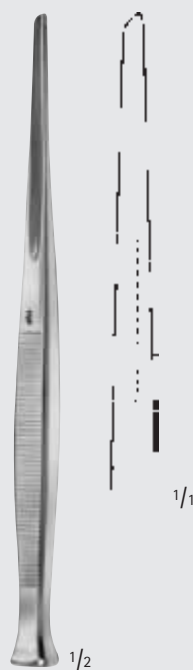

PARTSCH

<b>FL223R</b>	3 mm
<b>FL224R</b>	4 mm
<b>FL225R</b>	5 mm
<b>FL226R</b>	6 mm
<b>FL227R</b>	7 mm

Hohlmeißel

Gouges

170 mm, 6 3/4"



## Hämmer und Meißel – Mallets, Chisels and Gouges

Osteotome, Flach- und Hohlmeißel  
Osteotomes, Chisels and Gouges

FL

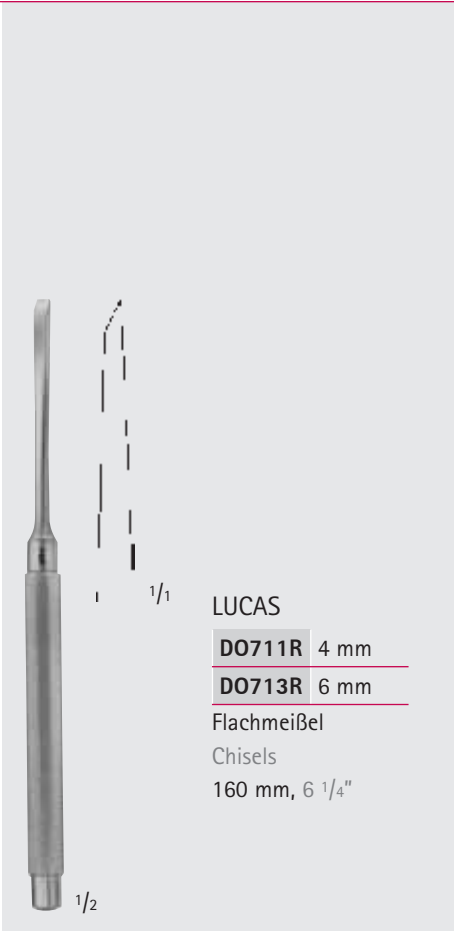

LUCAS

<b>DO711R</b>	4 mm
<b>DO713R</b>	6 mm

Flachmeißel

Chisels

160 mm, 6 1/4"

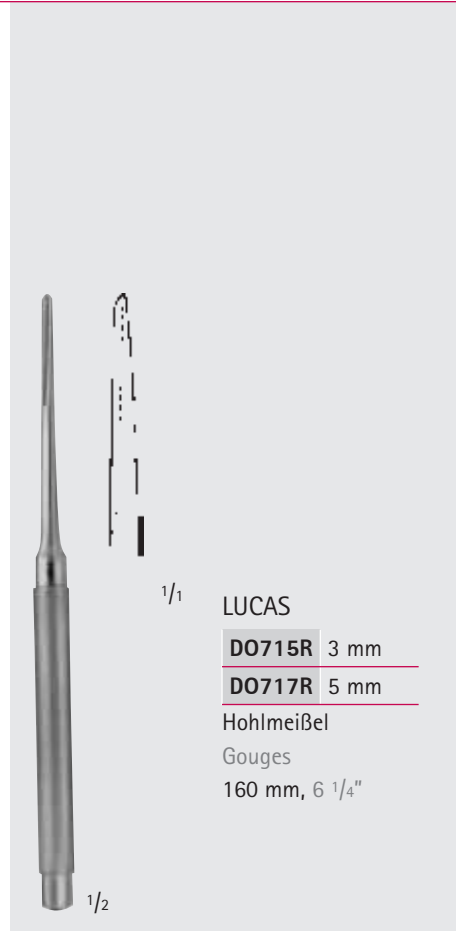

LUCAS

<b>DO715R</b>	3 mm
<b>DO717R</b>	5 mm

Hohlmeißel

Gouges

160 mm, 6 1/4"



ALEXANDER

<b>FL343R</b>	7 mm
<b>FL345R</b>	9 mm
<b>FL347R</b>	11 mm

Hohlmeißel

Gouges

170 mm, 6 3/4"

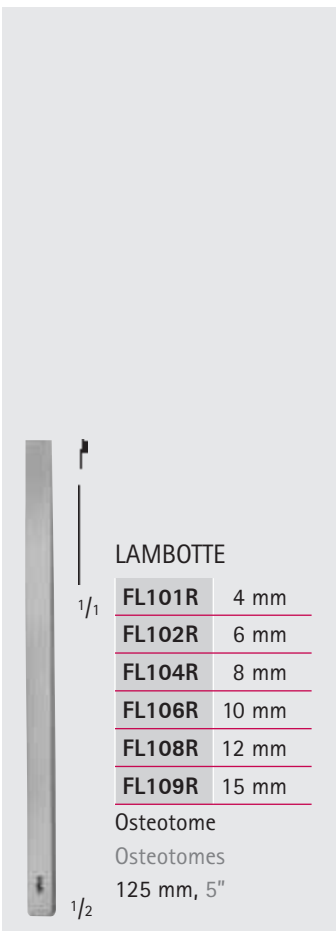

LAMBOTTE

<b>FL101R</b>	4 mm
<b>FL102R</b>	6 mm
<b>FL104R</b>	8 mm
<b>FL106R</b>	10 mm
<b>FL108R</b>	12 mm
<b>FL109R</b>	15 mm

Osteotome

Osteotomes

125 mm, 5"

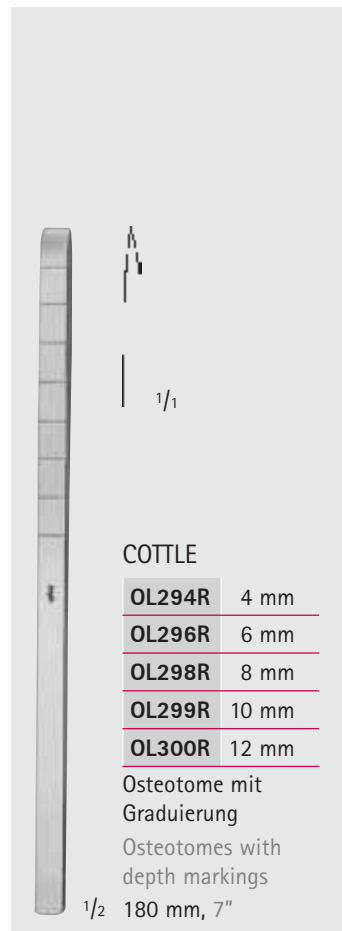

COTTLE

<b>OL294R</b>	4 mm
<b>OL296R</b>	6 mm
<b>OL298R</b>	8 mm
<b>OL299R</b>	10 mm
<b>OL300R</b>	12 mm

Osteotome mit  
Graduierung

Osteotomes with  
depth markings

180 mm, 7"

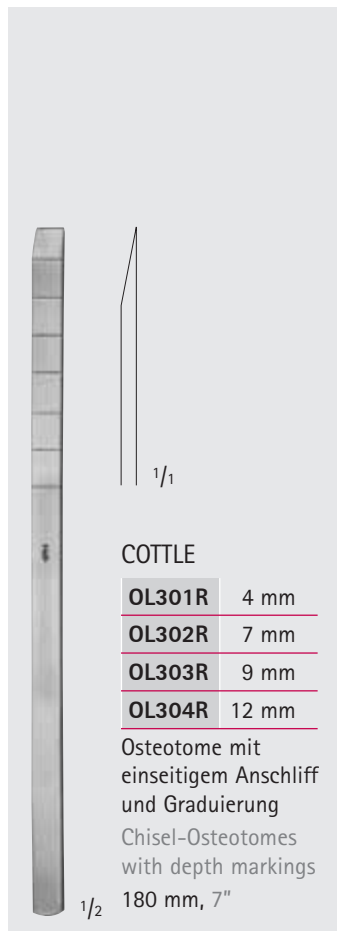

COTTLE

<b>OL301R</b>	4 mm
<b>OL302R</b>	7 mm
<b>OL303R</b>	9 mm
<b>OL304R</b>	12 mm

Osteotome mit  
einseitigem Anschlag  
und Graduierung

Chisel-Osteotomes  
with depth markings

180 mm, 7"

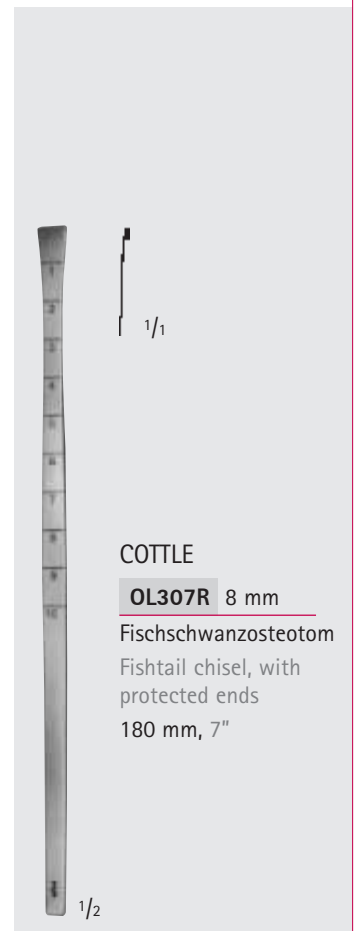

COTTLE

<b>OL307R</b>	8 mm
---------------	------

Fischschwanzosteotom

Fishtail chisel, with  
protected ends

180 mm, 7"



MILLIMETERS

## Hämmer und Meißel – Mallets, Chisels and Gouges

Flachmeißel und Osteotome

Chisels and Osteotomes

FL



EAST GRINSTEAD (WARD)

**DO722R** 3 mm

**DO723R** 5 mm

Flachmeißel

Chisels

180 mm, 7"

1/2



EASTMAN

**DO725R** 3 mm

**DO726R** 5 mm

Flachmeißel

Chisels

190 mm, 7 1/2"

1/2



EAST GRINSTEAD (WARD)

**DO732R** 3 mm

**DO733R** 5 mm

Osteotome

Osteotomes

180 mm, 7"

1/2



## Hämmer und Meißel – Mallets, Chisels and Gouges

Flach- und Hohlmeißel, Osteotome  
Chisels and Gouges, Osteotomes

FL

1/1

1/2 205 mm, 8"

**STILLE**

<b>FL503R</b>	10 mm
<b>FL504R</b>	12 mm
<b>FL505R</b>	15 mm
<b>FL506R</b>	20 mm
<b>FL507R</b>	25 mm

Flachmeißel  
Chisels

1/1

1/2 205 mm, 8"

**STILLE**

<b>FL573R</b>	10 mm
<b>FL574R</b>	12 mm
<b>FL575R</b>	15 mm
<b>FL576R</b>	20 mm
<b>FL577R</b>	25 mm

Hohlmeißel  
Gouges

1/1

1/2 205 mm, 8"

**WALTER**

<b>FL583R</b>	10 mm
<b>FL585R</b>	15 mm

Hohlmeißel zur  
Knorpelentnahme aus der  
Rippe  
Gouges for taking grafts  
from the ribs

1/1

1/2 205 mm, 8"

**STILLE**

<b>FL512R</b>	8 mm
<b>FL513R</b>	10 mm
<b>FL514R</b>	12 mm
<b>FL515R</b>	15 mm
<b>FL516R</b>	20 mm
<b>FL517R</b>	25 mm

Osteotome  
Osteotomes

1/1

1/2 205 mm, 8"

**STILLE**

<b>FL523R</b>	10 mm
<b>FL524R</b>	12 mm
<b>FL525R</b>	15 mm
<b>FL526R</b>	20 mm
<b>FL527R</b>	25 mm

Osteotome  
Osteotomes

1/1

1/2 205 mm, 8"

**STILLE**

<b>FL553R</b>	10 mm
<b>FL554R</b>	12 mm
<b>FL555R</b>	15 mm
<b>FL556R</b>	20 mm
<b>FL557R</b>	25 mm

Osteotome, gebogen  
Osteotomes, curved



# Hämmer und Meißel – Mallets, Chisels and Gouges

Osteotome

Osteotomes

FL



MB657R-MB662R



MB663R-MB669R



MB675R-MB684R



MB685R-MB694R



## SMITH-PETERSEN

MB657R	7 mm
MB658R	11 mm
MB659R	14 mm
MB660R	17 mm
MB661R	19 mm
MB662R	25 mm
MB663R	6 mm
MB664R	9,5 mm
MB665R	13 mm
MB666R	16 mm
MB667R	19 mm
MB668R	25 mm
MB669R	32 mm

1/2

205 mm, 8 1/8"



## HIBBS

MB675R	6 mm
MB676R	10 mm
MB677R	13 mm
MB678R	16 mm
MB679R	19 mm
MB680R	22 mm
MB681R	25 mm
MB682R	28 mm
MB683R	32 mm
MB684R	38 mm
MB685R	6 mm
MB686R	10 mm
MB687R	13 mm
MB688R	16 mm
MB689R	19 mm
MB690R	22 mm
MB691R	25 mm
MB692R	28 mm
MB693R	32 mm
MB694R	38 mm

1/2

240 mm, 9 1/2"





# Hämmer und Meißel – Mallets, Chisels and Gouges

Osteotome  
Osteotomes

FL



1/1

## LAMBOTTE

<b>FL650R</b>	4 mm
<b>FL651R</b>	8 mm
<b>FL652R</b>	10 mm
<b>FL653R</b>	13 mm
<b>FL654R</b>	15 mm
<b>FL655R</b>	18 mm
<b>FL656R</b>	20 mm
<b>FL658R</b>	25 mm
<b>FL659R</b>	30 mm
<b>FL660R</b>	38 mm
<b>FL661R</b>	44 mm
<b>FL662R</b>	50 mm

245 mm, 9 3/4"

1/2

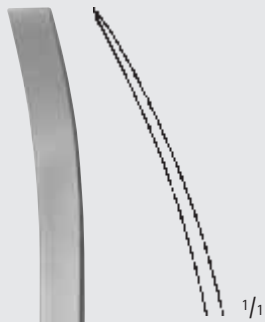

1/1

## LAMBOTTE

<b>FL781R</b>	8 mm
<b>FL783R</b>	13 mm
<b>FL785R</b>	18 mm
<b>FL788R</b>	25 mm
<b>FL789R</b>	30 mm
<b>FL790R</b>	38 mm

gebogen  
curved  
245 mm, 9 3/4"

1/2



1/1

## OBWEGESER

<b>DO720R</b>	11 mm
---------------	-------

gebogen  
curved  
235 mm, 9 1/4"

1/2

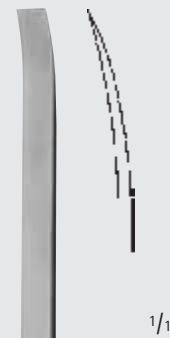

1/1

## NIEDERDELLMANN

<b>DO728R</b>	8 mm
<b>DO730R</b>	10 mm

gebogen  
curved  
250 mm, 10"

1/2

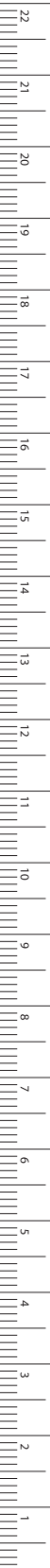

MILLIMETERS

## Hämmer und Meißel – Mallets, Chisels and Gouges

Osteotome, Flach- und Hohlmeißel mit PEEK-Griff

Osteotomes, Chisels and Gouges with PEEK-Handle

Dampfsterilisierbar bis 143°C (3 bar)

Can be sterilized in a steam sterilizer up to 143°C (3 bar)

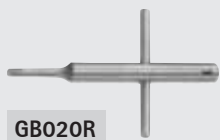

**FL665R**  
Meißelgriff für  
auswechselbare Klingen  
mit Spannschlüssel GB020R  
Handle for interchangeable  
blades, with key GB020R

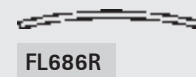
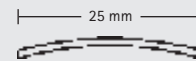
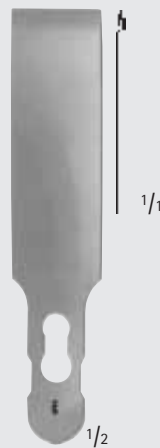
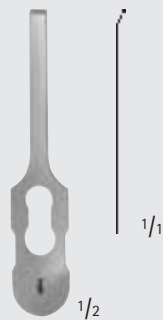



## Hämmer und Meißel – Mallets, Chisels and Gouges

Osteotome, Flach- und Hohlmeißel mit PEEK-Griff  
Osteotomes, Chisels and Gouges with PEEK-Handle

Dampfsterilisierbar bis 143°C (3 bar)

Can be sterilized in a steam sterilizer up to 143°C (3 bar)

FL



<b>DO750R</b>	10 mm
<b>DO752R</b>	15 mm
<b>DO754R</b>	20 mm

Flachmeißel  
Chisels  
200 mm, 8"



<b>DO751R</b>	10 mm
<b>DO753R</b>	15 mm
<b>DO755R</b>	20 mm

Flachmeißel, gebogen  
Chisels, curved  
200 mm, 8"



LEXER-MINI

<b>FL380R</b>	4 mm
<b>FL381R</b>	6 mm
<b>FL382R</b>	8 mm
<b>FL383R</b>	10 mm
<b>FL384R</b>	12 mm

Osteotome  
Osteotomes  
180 mm, 7"



LEXER-MINI

<b>FL390R</b>	4 mm
<b>FL391R</b>	6 mm
<b>FL392R</b>	8 mm
<b>FL393R</b>	10 mm
<b>FL394R</b>	12 mm

Hohlmeißel  
Gouges  
180 mm, 7"

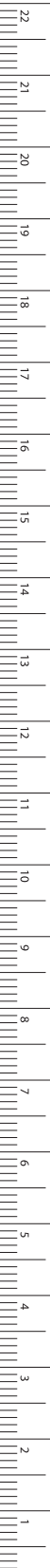

## Hämmer und Meißel – Mallets, Chisels and Gouges

Osteotome und Hohlmeißel mit PEEK-Griff

Osteotome and Gouges with PEEK-Handle

Dampfsterilisierbar bis 143°C (3 bar)

Can be sterilized in a steam sterilizer up to 143°C (3 bar)

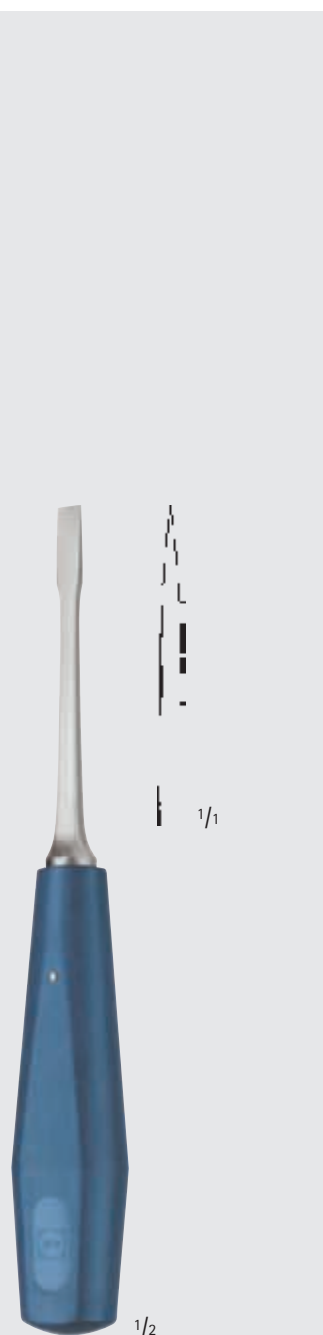

LEXER

<b>FL401R</b>	5 mm
<b>FL402R</b>	7 mm
<b>FL403R</b>	10 mm
<b>FL405R</b>	15 mm
<b>FL406R</b>	20 mm
<b>FL407R</b>	25 mm
<b>FL408R</b>	30 mm

Osteotome  
Osteotomes

220 mm, 8 3/4"

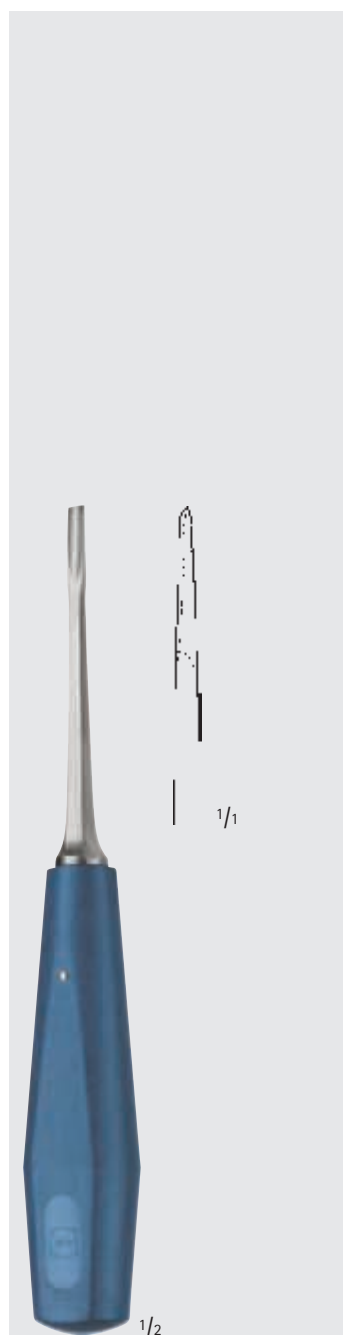

LEXER

<b>FL411R</b>	5 mm
<b>FL412R</b>	7 mm
<b>FL413R</b>	10 mm
<b>FL415R</b>	15 mm
<b>FL416R</b>	20 mm
<b>FL417R</b>	25 mm
<b>FL418R</b>	30 mm

Hohlmeißel  
Gouges

220 mm, 8 3/4"

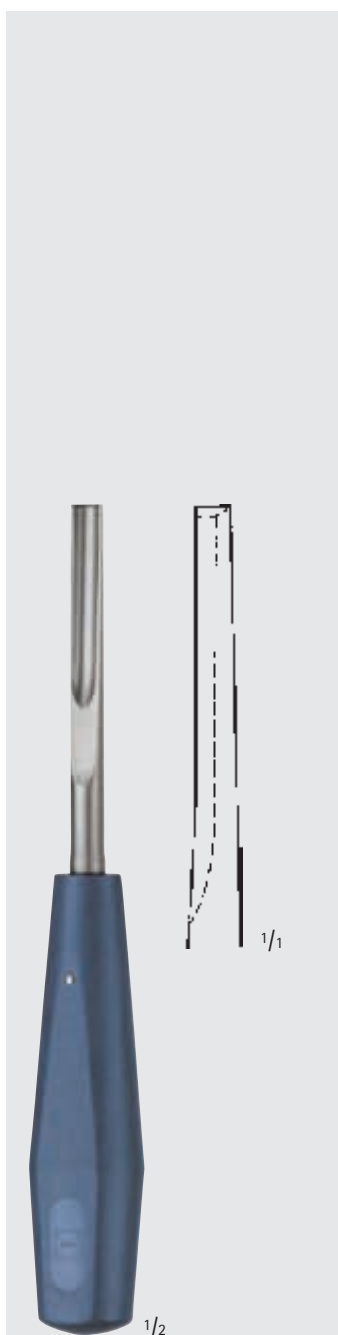

**FL420R** 9 mm

Hohlmeißel zum Freilegen  
abgebrochener Schrauben

Gouge for excavating  
broken screws

220 mm, 8 3/4"



ZIELKE

<b>FL701R</b>	5,5 mm
<b>FL702R</b>	9,0 mm

Hohlmeißel für  
Skoliose-Operationen

Gouges for scoliosis  
operations

230 mm, 9"

FL





## Hämmer und Meißel – Mallets, Chisels and Gouges

Hohlmeißel

Gouges

Dampfsterilisierbar bis 143°C (3 bar)

Can be sterilized in a steam sterilizer up to 143°C (3 bar)



<b>FL437R</b>	6 mm
<b>FL438R</b>	8 mm
<b>FL439R</b>	11 mm
<b>FL440R</b>	16 mm

Wirbelsäulenmeißel,  
bajonettförmig  
Lamina gouge, cranked  
235 mm, 9 1/4"

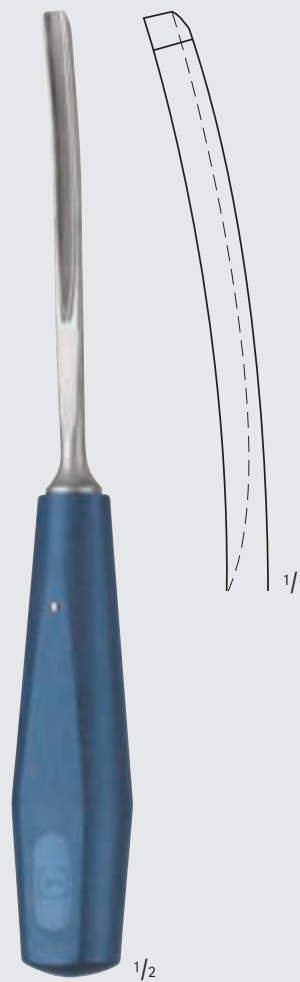

<b>FL441R</b>	5 mm
<b>FL443R</b>	10 mm
<b>FL445R</b>	15 mm

Spongiosa-Hohlmeißel,  
gebogen  
Spongiosa gouges, curved  
250 mm, 10"

FL

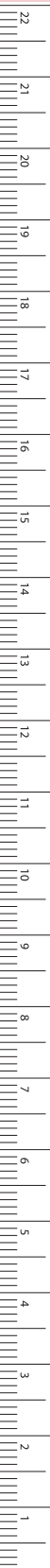

MILLIMETERS

## Hämmer und Meißel – Mallets, Chisels and Gouges

Osteotome und Flachmeißel mit PEEK-Griff

Osteotomes and Chisels with PEEK-Handle

Dampfsterilisierbar bis 143°C (3 bar)

Can be sterilized in a steam sterilizer up to 143°C (3 bar)

FL



**FL430R** 20 mm

Flachmeißel

Chisel

245 mm, 9 3/4"



**ND105R** 16 mm

Flachmeißel, gebogen

Chisel, curved

265 mm, 10 1/2"



LEXER

**ND108R** 10 mm

**ND109R** 15 mm

Osteotome, abgewinkelt

Osteotomes, angled

275 mm, 10 3/4"



LEXER

**FL423R**

Spongiosa-Hohlmeißel

Spongiosa gouge

280 mm, 11"



# Hämmer und Meißel – Mallets, Chisels and Gouges

Hohlmeißel





Gouges

Dampfsterilisierbar bis 143°C (3 bar)

Can be sterilized in a steam sterilizer up to 143°C (3 bar)

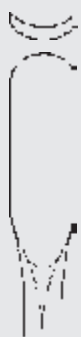
FL



		
	9 mm	15 mm <sup>1/1</sup>
	<b>ND120R</b>	<b>ND122R</b>
aufgebogen inclined forward		
	<b>ND121R</b>	<b>ND123R</b>
rückwärts gebogen inclined backward		
	<b>ND124R</b>	<b>ND125R</b>
gerade straight		

**WAGNER**

**ND120R-ND125R** <sup>1/2</sup>

Hohlmeißel zum Abtragen von Osteophyten sowie zum Anbringen von Verankerungsrillen im Acetabulum. Auch sehr gut geeignet zur Zemententfernung bei Reoperationen von Schaftprothesen.

Long handled thin concave gouges for removal of osteophytes as well as for creating small notches throughout the acetabular surface. The instruments can also be used for removing bone cement from the marrow-cavity when removing a total hip prosthesis.

340 mm, 13 1/2"

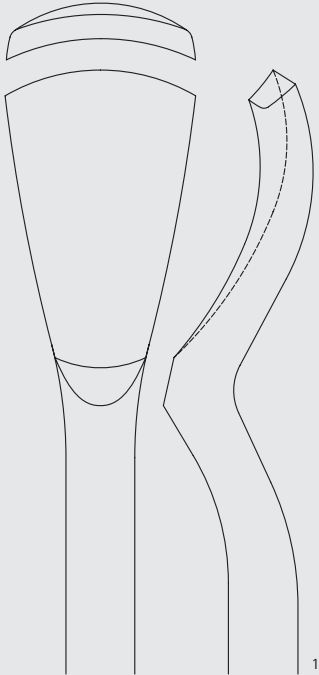
**ND118R** 25 mm <sup>1/2</sup>

290 mm, 11 1/4"



MILLIMETERS



INCHES



FO



**Knochenhaltezangen, Hohlmeißelzangen,  
Knochensplitterzangen**

Bone Holding Forceps, Bone Rongeurs,  
Bone Cutting Forceps

## Knochenhaltezangen, Hohlmeißelzangen – Bone Holding Forceps, Bone Rongeurs

Distraktor, Repositionszangen

Distractor, Reposition Forceps

FO

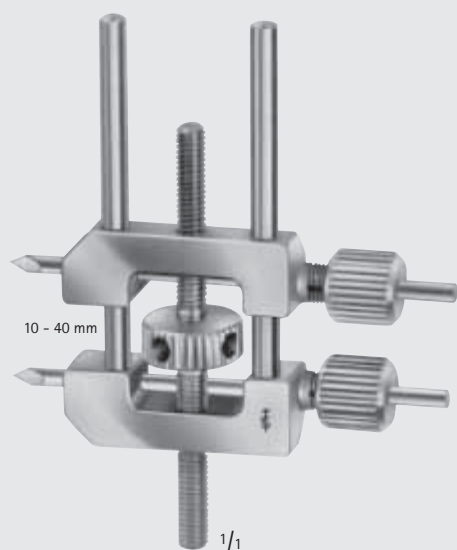

**LX310R**

Kleiner Distraktor, zum Distrahieren und Komprimieren von kleinen Knochen, für Bohrdrähte Ø 3,0 mm  
Small distractor, a repositioning device for distraction and compression of small bones, for wires with 3.0 mm diam.

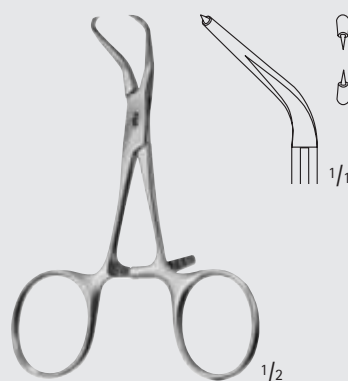

**FO113R**

Repositionszange mit abgesetzten Spitzen  
Reposition forceps with stepped tips  
95 mm, 3 3/4"

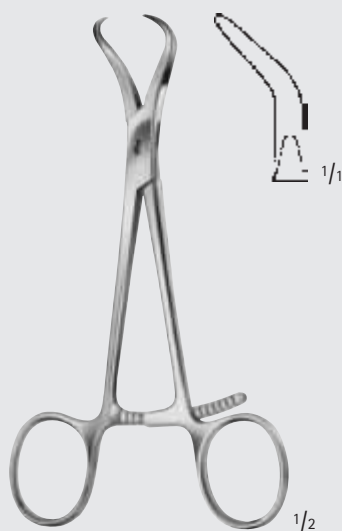

**FO115R**

Repositionszange für Kleinfragmente  
Reposition forceps for small fragments  
135 mm, 5 1/4"

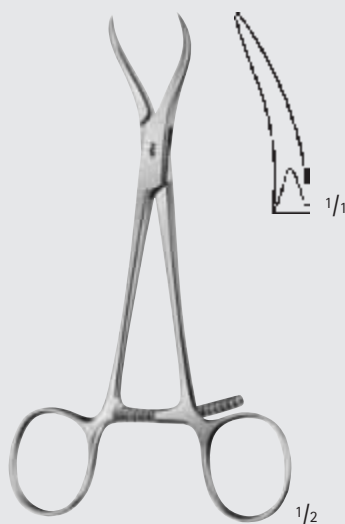

**FO117R**

Repositionszange, speziell für Kieferrepositionen  
Reposition forceps, especially for maxillary reposition  
135 mm, 5 1/4"

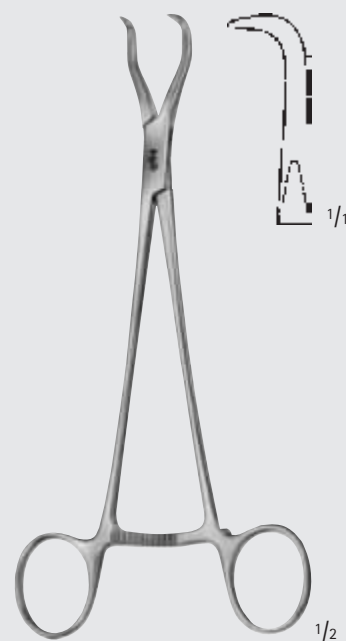

**HAASE**

**FO119R**

Repositionszange für Unterkieferfrakturen  
Reposition forceps for mandibular fractures  
165 mm, 6 1/2"



# Knochenhaltezangen, Hohlmeißelzangen – Bone Holding Forceps, Bone Rongeurs

## Repositionszangen, Repositionsstößel

### Reposition Forceps, Reposition Tamper

FO

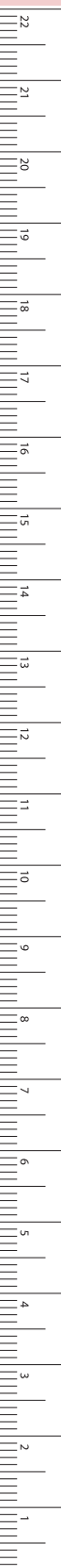

1/2

1/1

Zum Fixieren eines anzuschraubenden Knochenteils mittels KIRSCHNER-Bohrdraht bis Ø 2 mm  
A bone part to be screwed on is fixed by using a KIRSCHNER wire up to diam. 2 mm

**WÖRRLEIN**

**FO105R**

Repositionsstößel (Kronenspieß), längsdurchbohrt  
Reposition tamper, cannulated  
165 mm, 6 1/2"

1/2

1/1

**REILL**

**FO116R**

Repositionszange  
Reposition forceps  
170 mm, 6 3/4"

1/2

1/1

**FO118R**

Repositionszange  
Reposition forceps  
205 mm, 8"

1/2

1/1

**MEYER**

**FO106R**

Repositionszange für Finger, mit Bohrbüchse für KIRSCHNER-Drähte bis Ø 1 mm  
Reposition forceps for fingers, with drill guide for KIRSCHNER wires up to diam. 1 mm

170 mm, 6 3/4"

1/2

1/1

**MEYER**

**FO108R**

Repositionszange mit Bohrbüchse für KIRSCHNER-Drähte bis Ø 2 mm  
Reposition forceps with drill guide for KIRSCHNER wires up to diam. 2 mm

205 mm, 8"

## Knochenhaltezangen, Hohlmeißelzangen – Bone Holding Forceps, Bone Rongeurs

Repositionierzangen, Knochenhaltezangen  
 Reposition Forceps, Bone Holding Forceps

FO



1/2

**FO153R**

Patellazange  
 Patella forceps  
 185 mm, 7 1/4"



1/2

**FO112R**

Knöchelfasszange  
 Malleolar forceps  
 210 mm, 8 1/4"



1/2

**FO123R**

Zange mit Zahnsperre  
 Forceps with ratchet fixation  
 140 mm, 5 1/2"



1/2

**FO124R**

Zange mit Gewindesperre  
 Forceps with thread fixation  
 170 mm, 6 3/4"



1/2

**FO125R**

Zange mit Gewindesperre  
 Forceps with thread fixation  
 235 mm, 9 1/4"



# Knochenhaltezangen, Hohlmeißelzangen – Bone Holding Forceps, Bone Rongeurs

Knochenhaltezangen  
Bone Holding Forceps

FO



DINGMANN

**FO110R**

185 mm, 7 1/4"

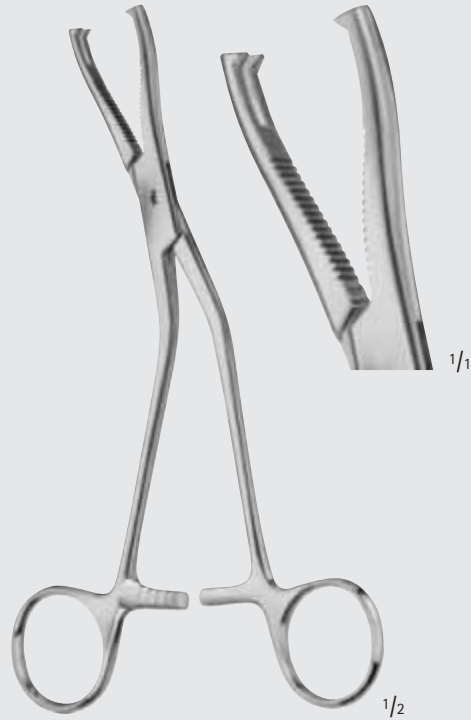

DINGMANN, MODIF.

**FO111R**

185 mm, 7 1/4"



**FO100R**

Sequesterzange  
Sequestrum forceps  
200 mm, 8"

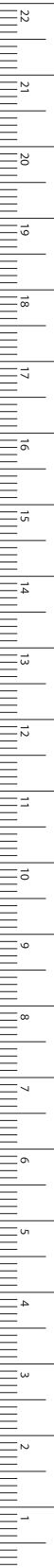

MILLIMETERS

# Knochenhaltezangen, Hohlmeißelzangen – Bone Holding Forceps, Bone Rongeurs

Knochenhaltezangen  
Bone Holding Forceps

FO



5 mm  
1/1

1/2

**FO120R**

200 mm, 8"



11 mm  
1/1

1/2

**LANGENBECK**

**FO127R**

205 mm, 8"



12 mm  
1/1

1/2

**FERGUSSON**

**FO130R**

205 mm, 8"



8 mm  
1/1

1/2

**SEMB**

**FO135R**

190 mm, 7 1/2"



8 mm  
1/1

1/2

**SEMB**

**FO136R**

190 mm, 7 1/2"



# Knochenhaltezangen, Hohlmeißelzangen – Bone Holding Forceps, Bone Rongeurs

Knochenhaltezangen  
Bone Holding Forceps

FO



im Maul verstellbar  
jaw adjustable



FARABEUF

**FO140R**

230 mm, 9"



FARABEUF

**FO141R**

255 mm, 10"



FARABEUF-LAMBOTTE

**FO143R**

255 mm, 10"



MILLIMETERS

# Knochenhaltezangen, Hohlmeißelzangen – Bone Holding Forceps, Bone Rongeurs

Knochenhaltezangen  
Bone Holding Forceps

FO



KERN-LANE  
**FO150R**  
240 mm, 9 1/2"



LANE  
**FO151R**  
330 mm, 13 1/8"





# Knochenhaltezangen, Hohlmeißelzangen – Bone Holding Forceps, Bone Rongeurs

Knochenhaltezangen  
Bone Holding Forceps

FO



KERN-MINI

**FO148R**

155 mm, 6"



KERN-LANE

**FO158R**

240 mm, 9 1/2"



LANE

**FO159R**

320 mm, 12 3/4"



MILLIMETERS

# Knochenhaltezangen, Hohlmeißelzangen – Bone Holding Forceps, Bone Rongeurs

Knochenhaltezangen  
Bone Holding Forceps

FO



HEY GROVES

**FO144R**

210 mm, 8 1/4"



HEY GROVES

**FO145R**

270 mm, 10 3/4"



HEY GROVES

**FO146R**

305 mm, 12"



# Knochenhaltezangen, Hohlmeißelzangen – Bone Holding Forceps, Bone Rongeurs

## Knochenhaltezangen Bone Holding Forceps

FO

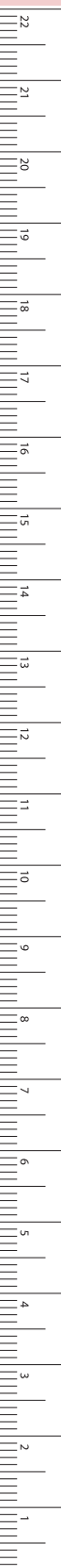

**FO169R-FO173R**

selbstzentrierend mit Gewindesperre  
self-centering forceps with thread fixation

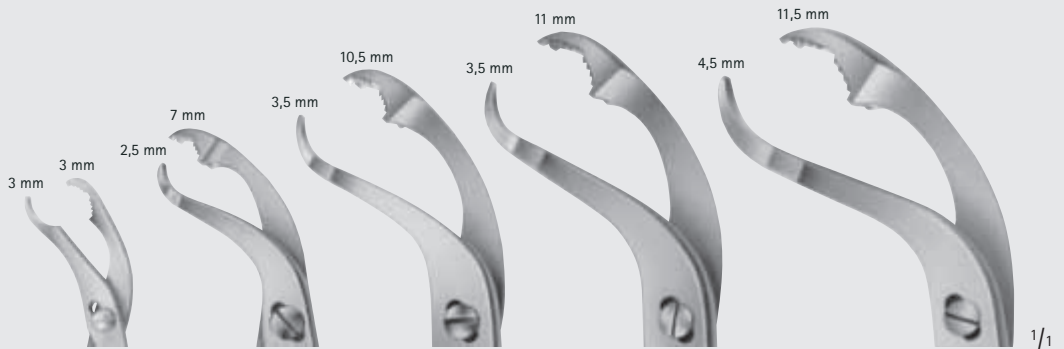

**FO169R**

145 mm  
5 3/4"

für Klein-  
fragmente  
for small  
fragments

**FO170R**

190 mm  
7 1/2"

**FO171R**

240 mm  
9 1/2"

**FO172R**

260 mm  
10 1/4"

**FO173R**

280 mm  
11"



VERBRUGGE

**FO180R**

175 mm, 7"



Fig. 1

**FO181R**

255 mm  
10"

Fig. 2

**FO182R**

265 mm  
10 1/2"

Fig. 3

**FO183R**

270 mm  
10 3/4"

VERBRUGGE

**FO181R-FO183R**

mit Lappenverschluss  
with lip joint

# Knochenhaltezangen, Hohlmeißelzangen – Bone Holding Forceps, Bone Rongeurs

Knochenhaltezangen  
Bone Holding Forceps

FO



Maulteil beweglich  
movable jaw



**FO160R**

220 mm

8 3/4"



**FO161R**

260 mm

10 1/4"



**FO162R**

330 mm

13 1/8"

LAMBOTTE

**FO160R-FO162R**

# Knochenhaltezangen, Hohlmeißelzangen – Bone Holding Forceps, Bone Rongeurs

Knochenhalteklammern  
Bone Clamps

FO

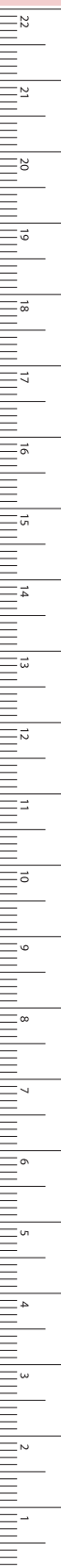

LOWMAN

**FO190R** 170 mm, 6 3/4"

**FO191R** 205 mm, 8"



LOWMAN-GERSTER

**FO192R**

210 mm, 8 1/4"

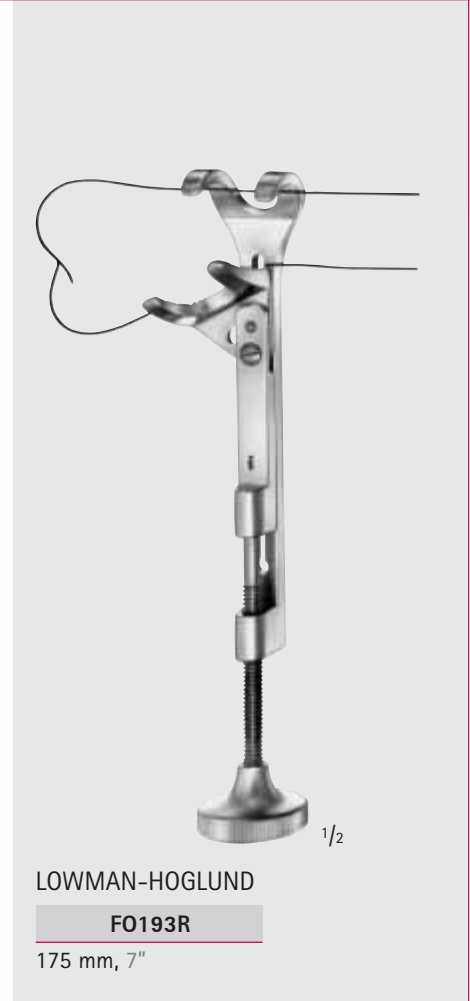

LOWMAN-HOGLUND

**FO193R**

175 mm, 7"

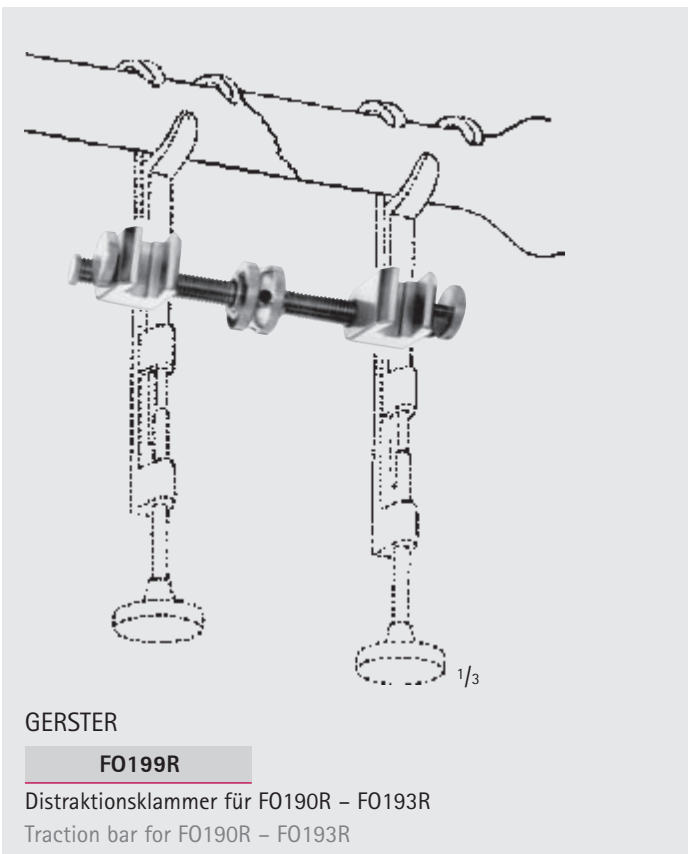

GERSTER

**FO199R**

Distraktionsklammer für FO190R – FO193R  
Traction bar for FO190R – FO193R

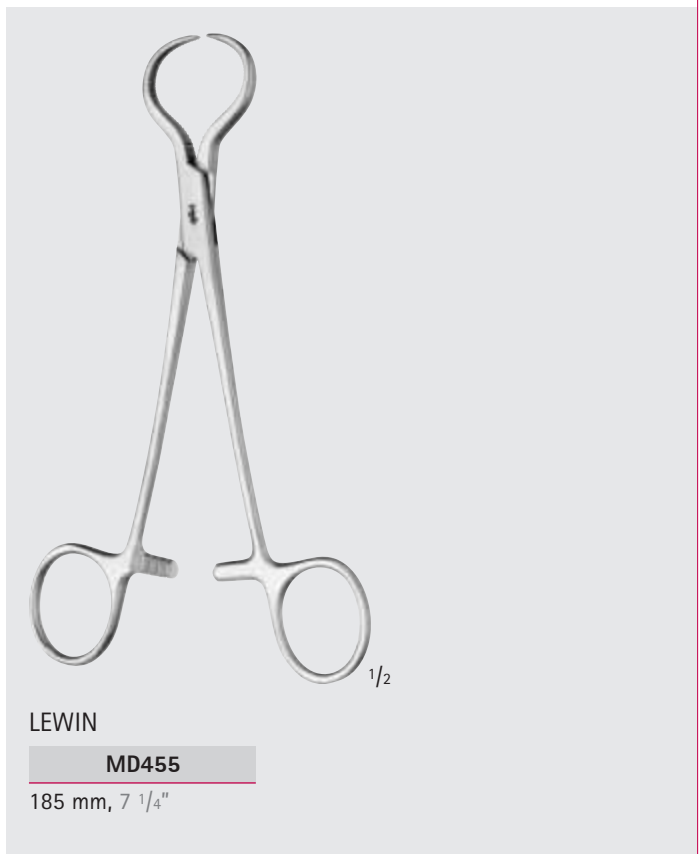

LEWIN

**MD455**

185 mm, 7 1/4"

## Knochenhaltezangen, Hohlmeißelzangen – Bone Holding Forceps, Bone Rongeurs

Synovektomie-Zangen, Hohlmeißelzangen

Synovectomy-Rongeurs, Bone Rongeurs

FO



**FO599R**

Synovektomie-Zange  
Maulbreite 2 mm  
Synovectomy rongeur  
jaw width 2 mm  
130 mm, 5 1/8"



STELLBRINK

**FO399R**

Synovektomie-Zange  
Synovectomy rongeur  
175 mm, 7"



STELLBRINK

**FO400R**

Synovektomie-Zange  
Synovectomy rongeur  
170 mm, 6 3/4"



**FO408R**

Hohlmeißelzangen  
Bone rongeurs  
145 mm, 5 3/4"

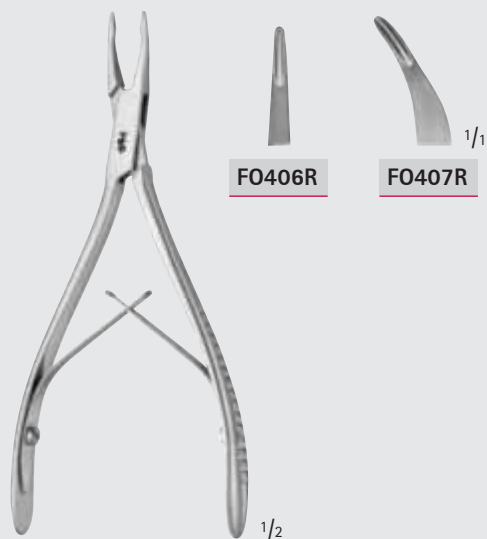

FRIEDMANN

**FO406R-FO407R**

Hohlmeißelzange  
Bone rongeur  
140 mm, 5 1/2"



LUER-FRIEDMANN

**FO409R**

Hohlmeißelzangen  
Bone rongeurs  
145 mm, 5 3/4"



# Knochenhaltezangen, Hohlmeißelzangen – Bone Holding Forceps, Bone Rongeurs

Hohlmeißelzangen  
Bone Rongeurs

FO



**FO413R**

150 mm, 6"



**FO410R**

140 mm, 5 1/2"



LUER

**FO411R**

150 mm, 6"



MILLIMETERS

# Knochenhaltezangen, Hohlmeißelzangen – Bone Holding Forceps, Bone Rongeurs

Hohlmeißelzangen

Bone Rongeurs

FO

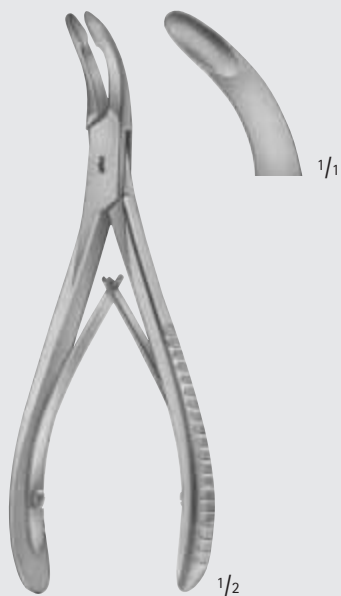

LUER

**FO412R**

155 mm, 6"



BLUMENTHAL

**FO415R**

155 mm, 6"



BLUMENTHAL

**FO416R**

150 mm, 6"



HAKANSSON

**FO428R**

170 mm, 6 3/4"



JANSEN

**FO430R-FO432R**

175 mm, 7"



BANE-HARTMANN

**FO457R**

175 mm, 7"





# Knochenhaltezangen, Hohlmeißelzangen – Bone Holding Forceps, Bone Rongeurs

Hohlmeißelzangen

Bone Rongeurs

FO

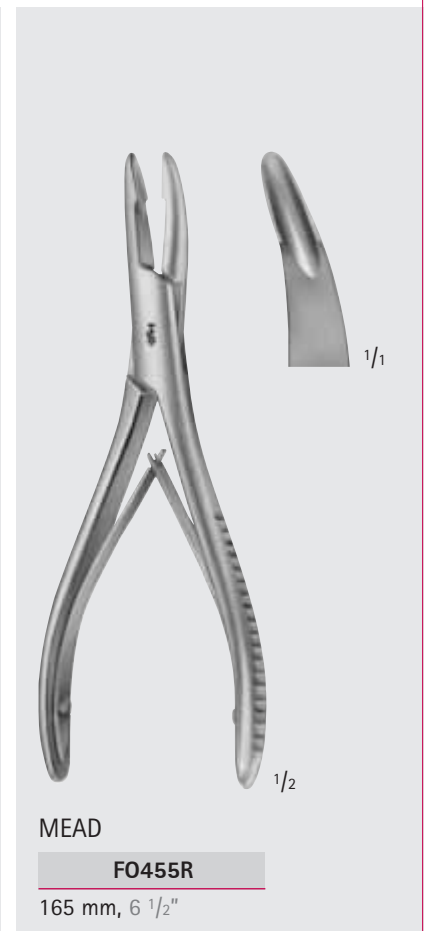
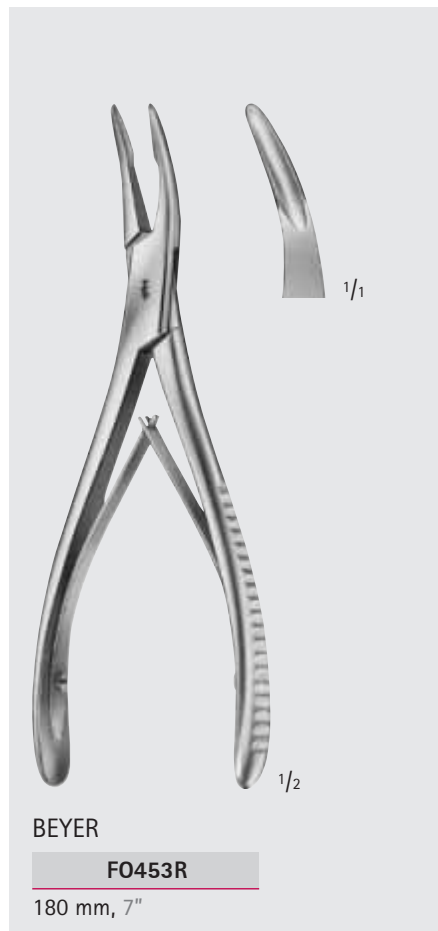
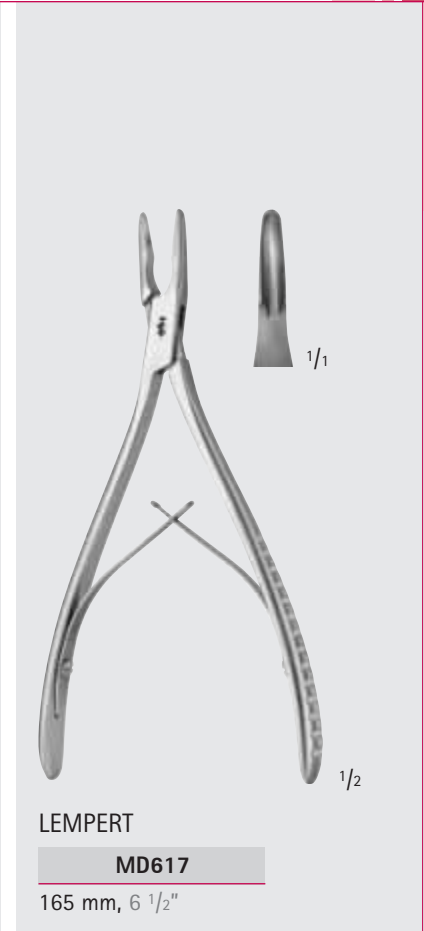
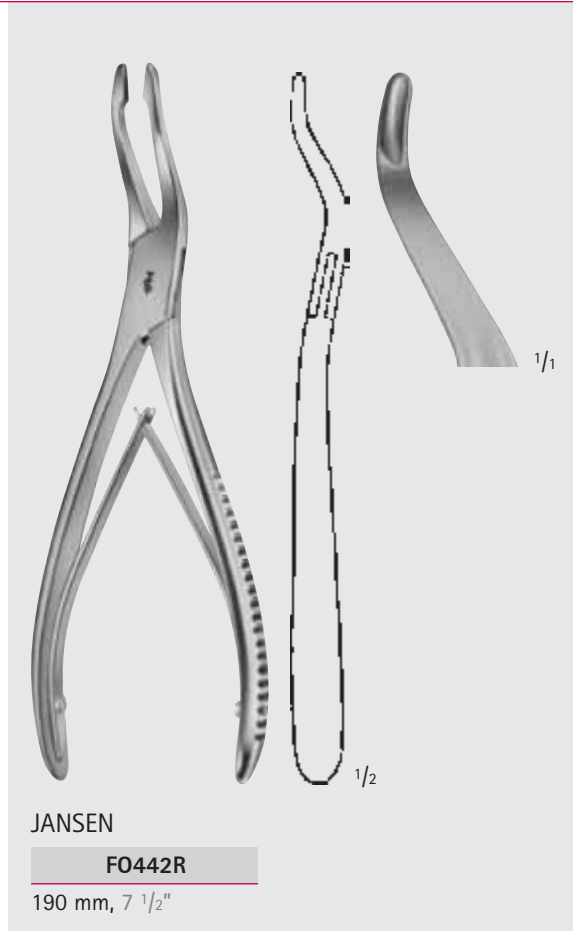
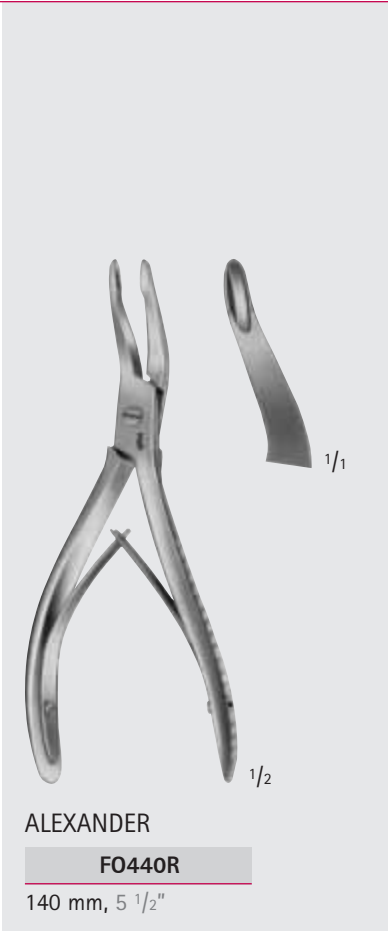

# Knochenhaltezangen, Hohlmeißelzangen – Bone Holding Forceps, Bone Rongeurs

Hohlmeißelzangen

Bone Rongeurs

FO

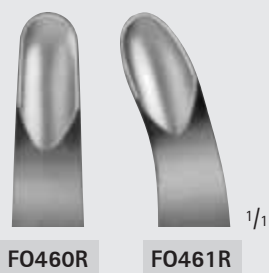

FO460R

FO461R

1/2

LUER

FO460R-FO461R

175 mm, 7"



1/1

1/2

LUER

FO462R

180 mm, 7"



1/1

1/2

LUER

FO463R

180 mm, 7"



1/1

1/2

OLIVECRONA

FO470R

205 mm, 8"



1/1

1/2

GULEKE

FO472R

205 mm, 8"

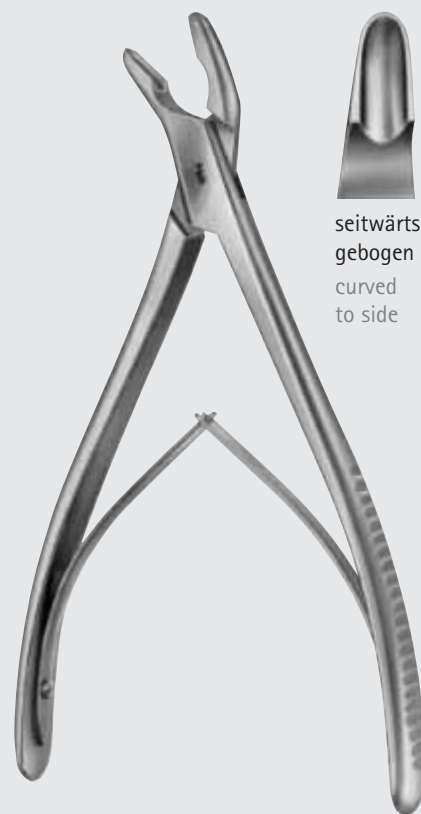

1/1

seitwärts  
gebogen  
curved  
to side

1/2

TROTTER

FO467R

205 mm, 8"



**Knochenhaltezangen, Hohlmeißelzangen – Bone Holding Forceps, Bone Rongeurs**  
Hohlmeißelzangen  
Bone Rongeurs

**FO**

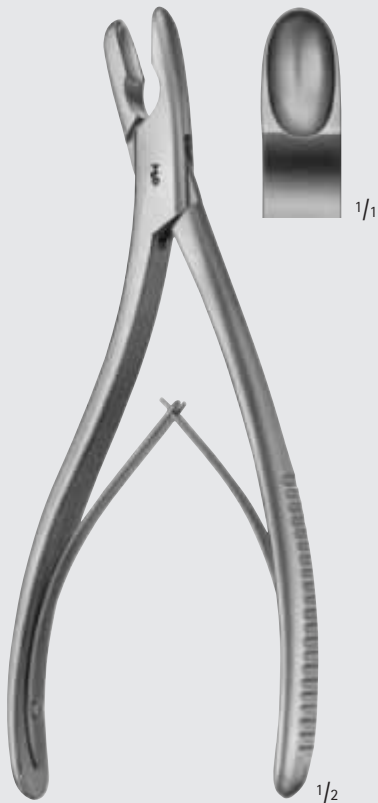

**NORTHFIELD**  
**FO474R**  
210 mm, 8 1/4"

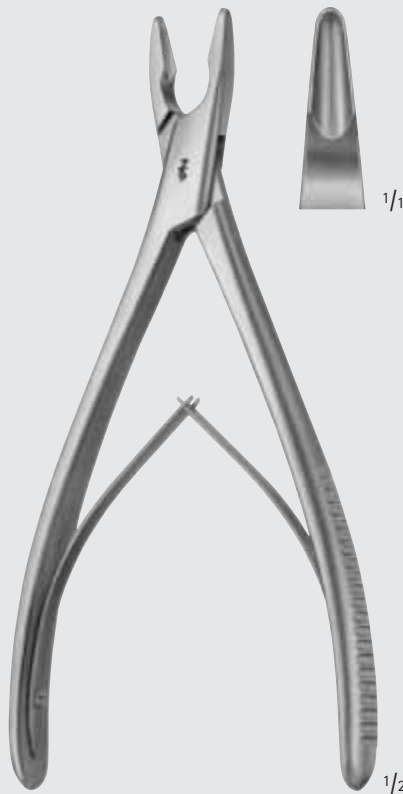

**PENNYBACKER**  
**FO475R**  
205 mm, 8"

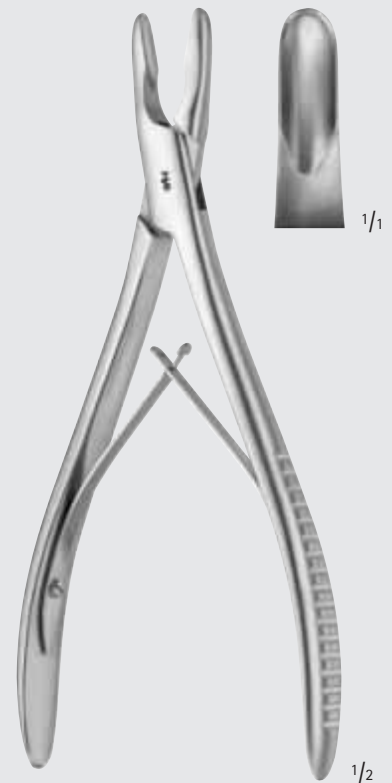

**ADSON**  
**MD615**  
200 mm, 8"

# Knochenhaltezangen, Hohlmeißelzangen – Bone Holding Forceps, Bone Rongeurs

Hohlmeißelzangen

Bone Rongeurs

FO

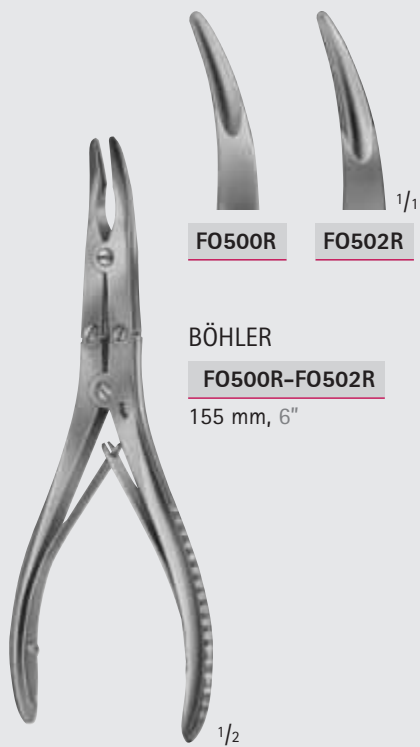

**FO500R** **FO502R** <sup>1/1</sup>

BÖHLER

**FO500R-FO502R**

155 mm, 6"

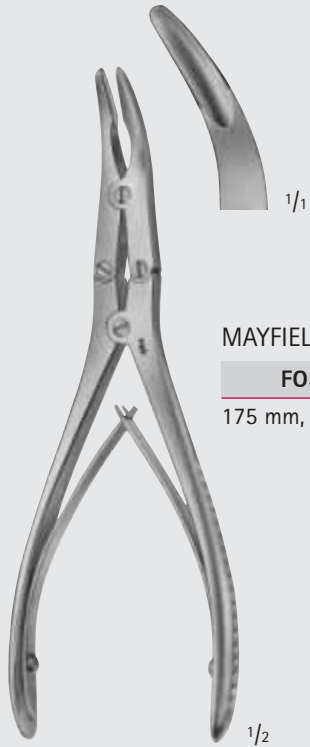

MAYFIELD

**FO511R**

175 mm, 7"



MARQUARDT

**FO520R**

200 mm, 8"

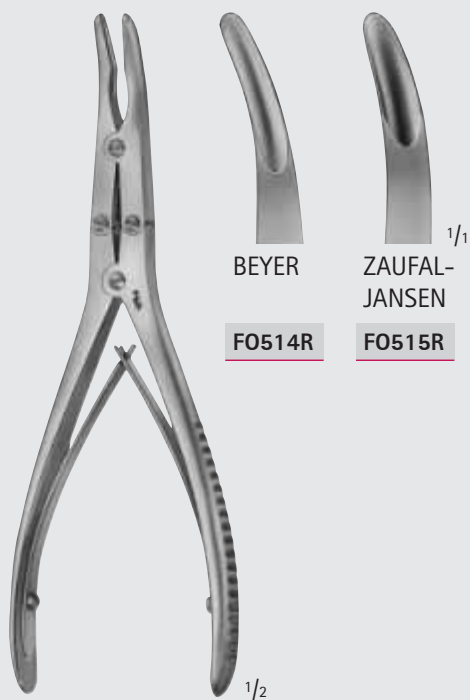

BEYER

**FO514R**

ZAUFAL-  
JANSEN

**FO515R**

**FO514R-FO515R**

180 mm, 7"



RUSKIN

**FO518R**

190 mm, 7 1/2"



RÖTTGEN-RUSKIN

**FO521R**

240 mm, 9 1/2"



**Knochenhaltezangen, Hohlmeißelzangen – Bone Holding Forceps, Bone Rongeurs**  
 Hohlmeißelzangen  
 Bone Rongeurs

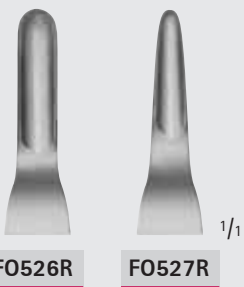

**FO526R**

**FO527R**



1/2

**LEKSELL**

**FO526R-FO527R**

245 mm, 9 3/4"



**FO522R**

**FO523R**



1/2

**ECHLIN**

**FO522R-FO523R**

230 mm, 9"



1/2

**FRYKHOLM**

**FO525R**

240 mm, 9 1/2"

**FO**

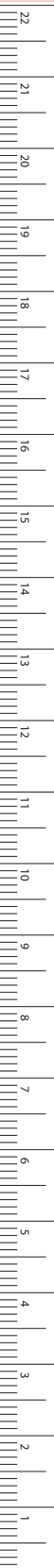

MILLIMETERS

# Knochenhaltezangen, Hohlmeißelzangen – Bone Holding Forceps, Bone Rongeurs

Hohlmeißelzangen

Bone Rongeurs

FO



STILLE

**FO530R**

230 mm, 9"



LEKSELL-STILLE

**FO532R**

240 mm, 9 1/2"



STILLE-RUSKIN

**FO534R**

240 mm, 9 1/2"



# Knochenhaltezangen, Hohlmeißelzangen – Bone Holding Forceps, Bone Rongeurs

Hohlmeißelzangen  
Bone Rongeurs

FO



LUER-STILLE

**FO550R**

225 mm, 9"

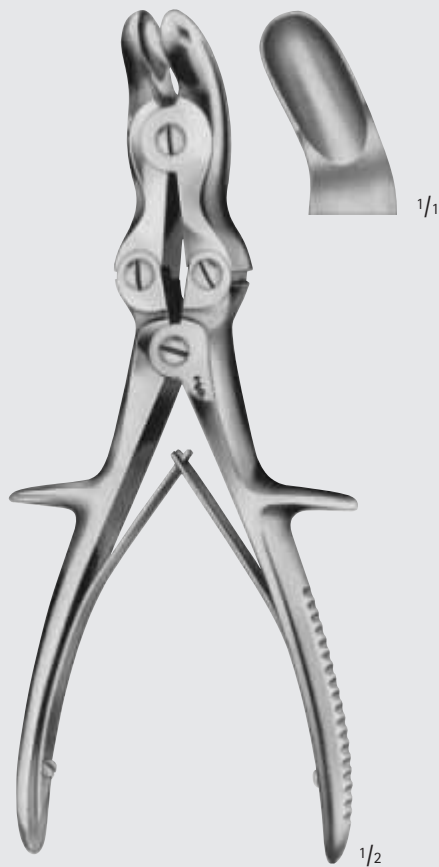

LUER-STILLE

**FO551R**

225 mm, 9"



SYPERT

**FG052R**

360 mm, 14 1/2"



MILLIMETERS

# Knochenhaltezangen, Hohlmeißelzangen – Bone Holding Forceps, Bone Rongeurs

Hohlmeißelzangen

Bone Rongeurs

FO



LUER-STILLE

**FO566R**

270 mm, 10 3/4"



SEMB

**FO555R**

240 mm, 9 1/2"





**Knochenhaltezangen, Hohlmeißelzangen – Bone Holding Forceps, Bone Rongeurs**  
Hohlmeißelzangen  
Bone Rongeurs

FO



MILLIMETERS



1/2



FO570R



FO572R

1/1

SAUERBRUCH-CORYLLOS

FO570R-FO572R

310 mm, 12 3/8"

**Knochenhaltezangen, Hohlmeißelzangen – Bone Holding Forceps, Bone Rongeurs**  
 Knochensplitterzangen  
 Bone Cutting Forceps

FO

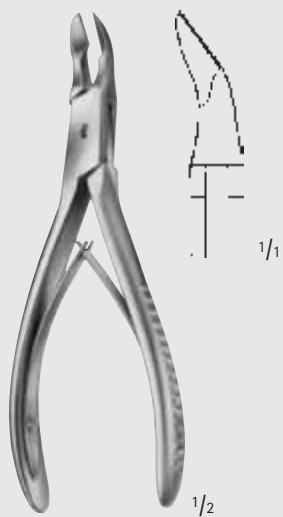

**FO601R**

130 mm, 5 1/8"

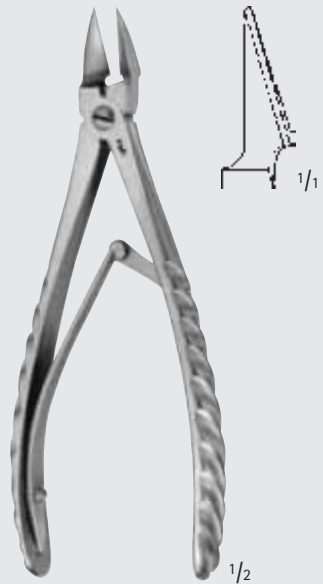

STAMM

**FO604R**

150 mm, 6"

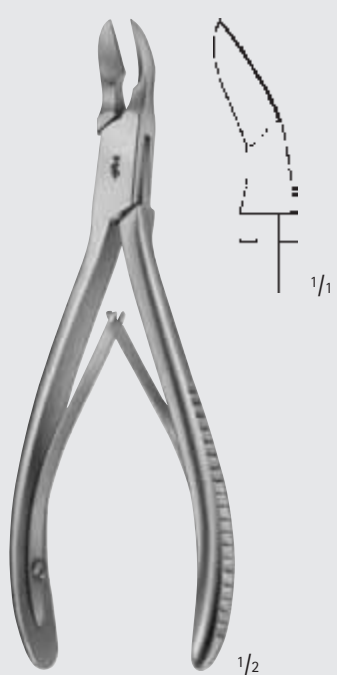

**FO602R**

170 mm, 6 3/4"

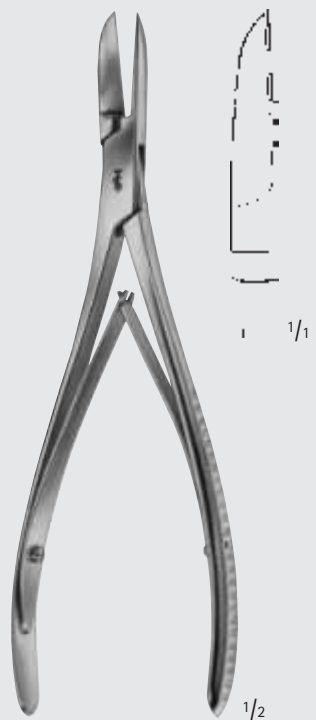

KAZANJIAN

**OK378R**

185 mm, 7 1/2"



# Knochenhaltezangen, Hohlmeißelzangen – Bone Holding Forceps, Bone Rongeurs

## Knochensplitterzangen Bone Cutting Forceps

FO



MILLIMETERS

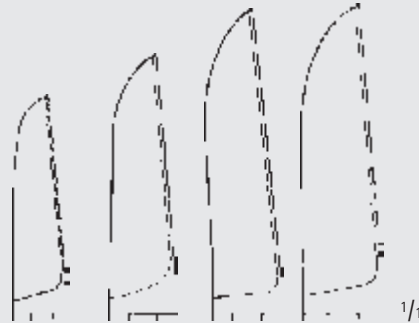

FO620R	FO622R	FO624R	FO626R
140 mm	170 mm	200 mm	220 mm
5 1/2"	6 3/4"	8"	8 3/4"

LISTON

FO620R-FO626R



FO632R	FO634R	FO636R
170 mm	200 mm	220 mm
6 3/4"	8"	8 3/4"

LISTON

FO632R-FO636R

# Knochenhaltezangen, Hohlmeißelzangen – Bone Holding Forceps, Bone Rongeurs

Knochensplitterzangen

Bone Cutting Forceps

FO



BÖHLER

**FO610R**

145 mm, 5 3/4"



BÖHLER

**FO611R**

145 mm, 5 3/4"



**FO612R**

170 mm, 6 3/4"

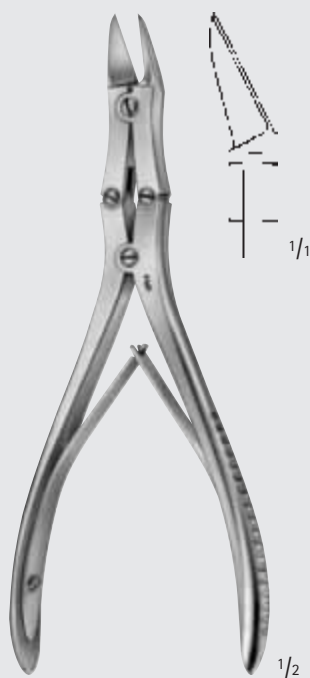

MC INDOE

**FO614R**

175 mm, 7"



RUSKIN-LISTON

**FO640R**

190 mm, 7 1/2"

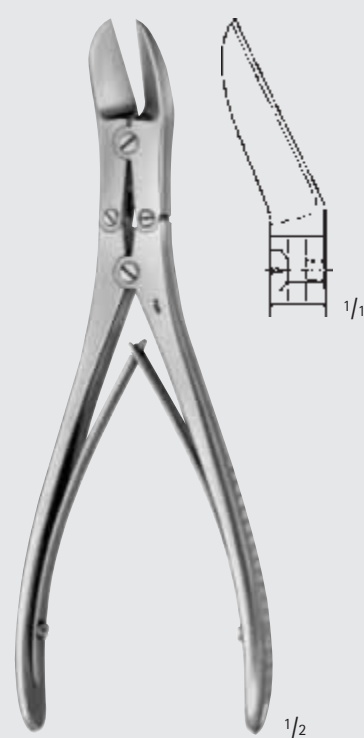

RUSKIN-LISTON

**FO641R**

190 mm, 7 1/2"

**Knochenhaltezangen, Hohlmeißelzangen – Bone Holding Forceps, Bone Rongeurs**  
 Knochensplitterzangen  
 Bone Cutting Forceps

**FO**

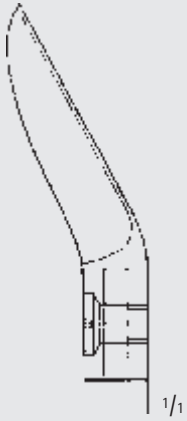
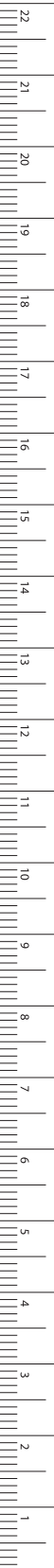

**LISTON**

**FO645R**

aufgebogen  
 curved on flat  
 240 mm, 9 1/2"



**LISTON**

**FO646R**

gerade  
 straight  
 280 mm, 11"

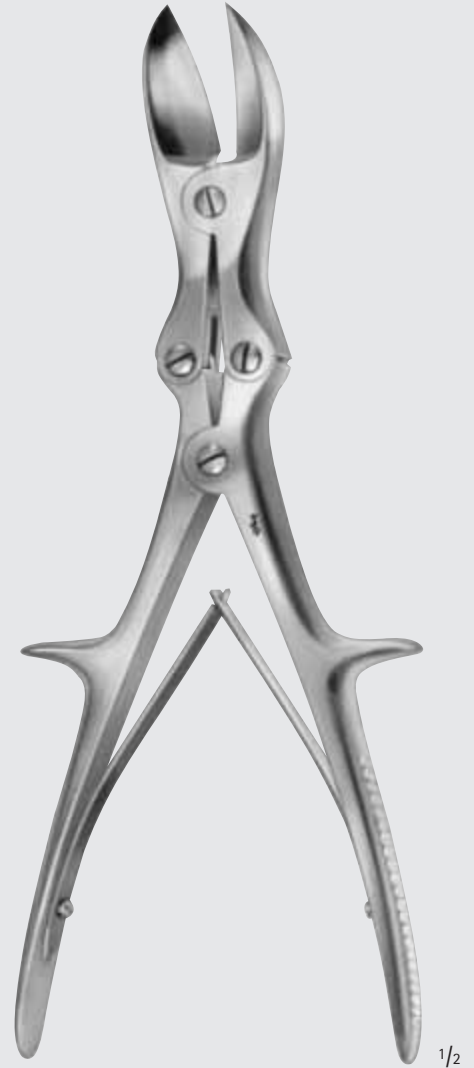
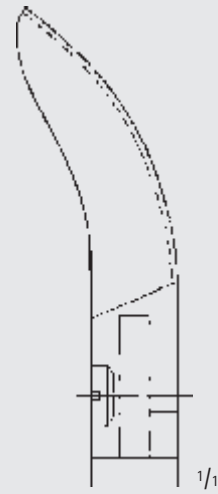

**LISTON**

**FO647R**

aufgebogen  
 curved on flat  
 280 mm, 11"

**Knochenhaltezangen, Hohlmeißelzangen – Bone Holding Forceps, Bone Rongeurs**  
 Knochensplitterzangen  
 Bone Cutting Forceps

FO

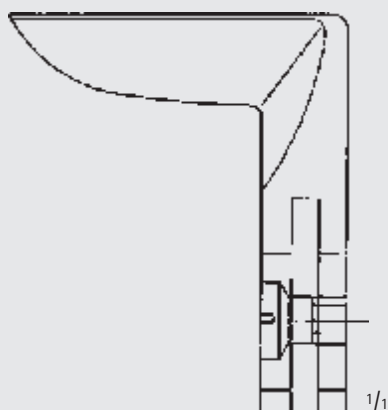

LISTON-STILLE

**FO648R**

265 mm, 10 1/2"



LISTON-KEY-HORSLEY  
 (TUDOR EDWARDS)

**FO649R**

255 mm, 10"

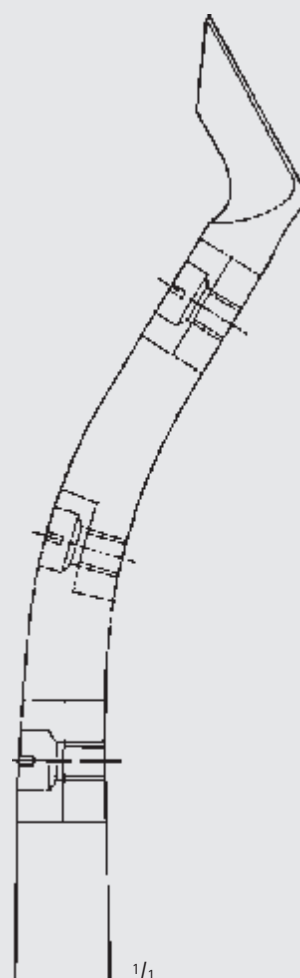



**Knochenhaltezangen, Hohlmeißelzangen – Bone Holding Forceps, Bone Rongeurs**  
 Meniskus- und Knorpelzangen  
 Meniscus- and Cartilage Forceps

**FO**

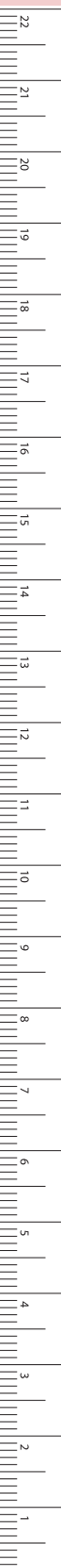

**BIRCHER**  
**FO800R**  
 200 mm, 8"

**BIRCHER**  
**FO801R**  
 200 mm, 8"

**WELLER**  
**FO807R**  
 200 mm, 8"

**BIRCHER-GANSKE**  
**FO808R**  
 200 mm, 8"

**BIRCHER-GANSKE**  
**FO810R**  
 200 mm, 8"

**MARTIN**  
**FO816R**  
 205 mm, 8"

# Knochenhaltezangen, Hohlmeißelzangen – Bone Holding Forceps, Bone Rongeurs

Meniskusmesser

Meniscus Knives

FO

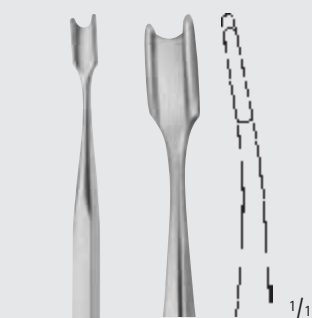

1  
SMILLIE

**FO855R**

170 mm, 6 3/4"

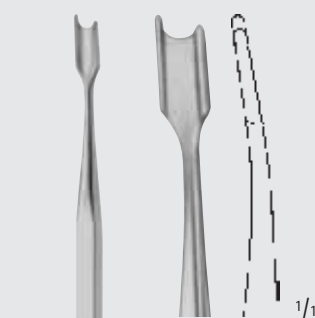

2  
SMILLIE

**FO856R**

170 mm, 6 3/4"

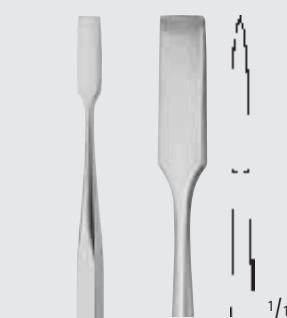

3  
SMILLIE

**FO857R**

170 mm, 6 3/4"





# Knochenhaltezangen, Hohlmeißelzangen – Bone Holding Forceps, Bone Rongeurs

## Wund- und Meniskushaken Retractors and Knee Retractors

FO

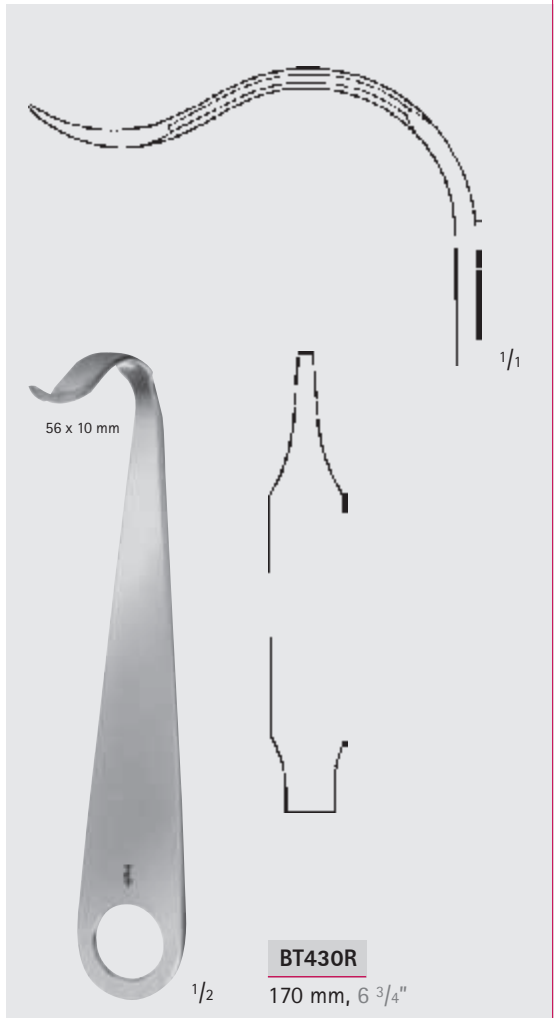
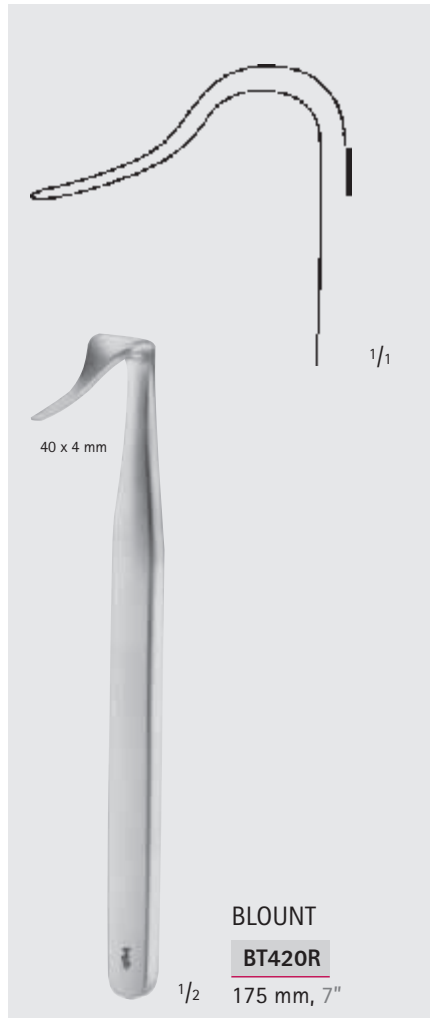
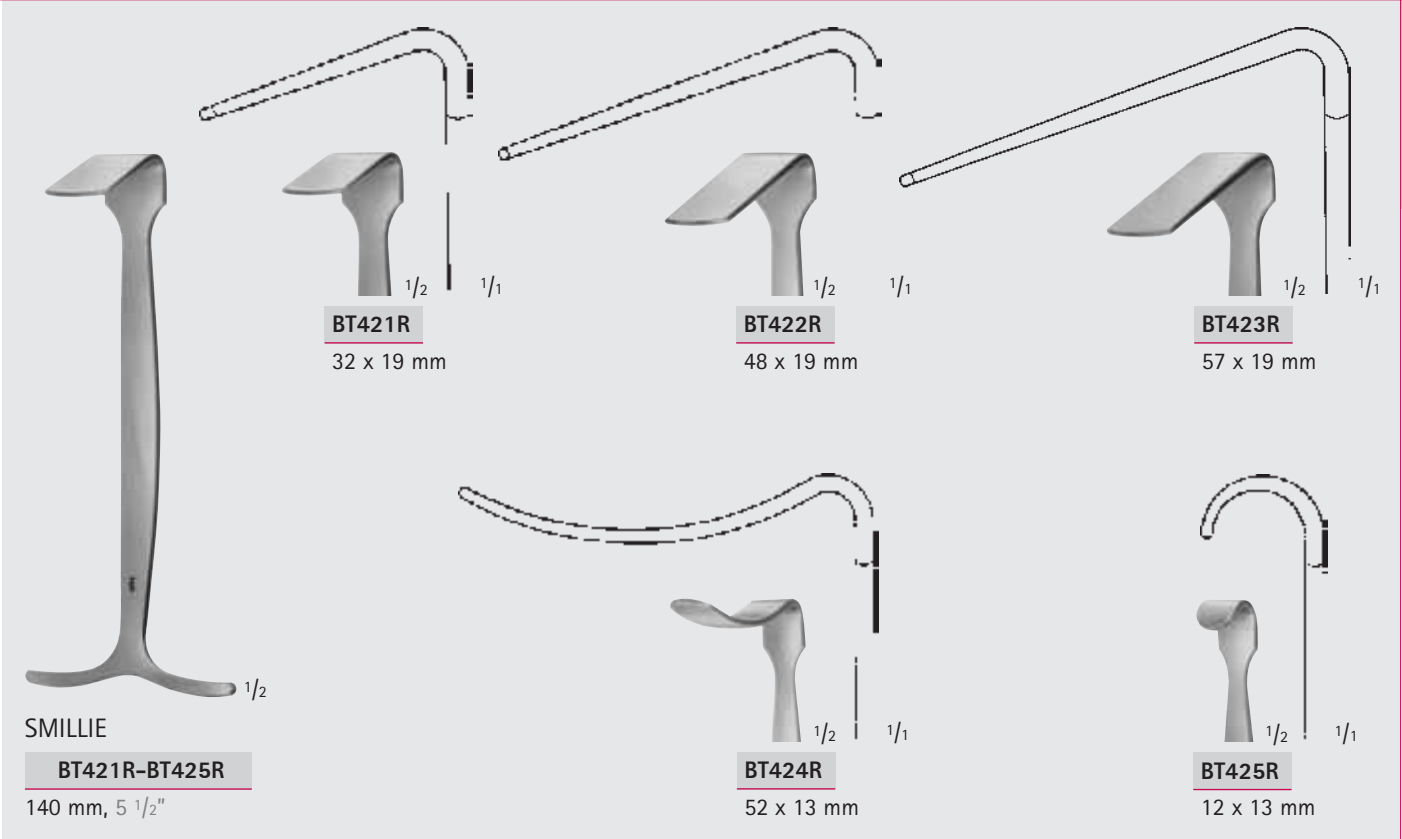
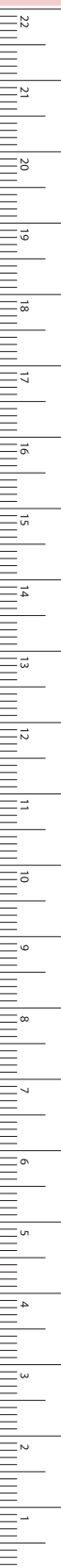

# Knochenhaltezangen, Hohlmeißelzangen – Bone Holding Forceps, Bone Rongeurs

## Sehnenstripper

## Tendon Strippers

FO



1/1

1/2

Ø  
diam.

**FO923R** 3 mm

Sehnenstripper  
Schaftlänge: 190 mm  
Tendon stripper  
Shaft length: 7 1/2"  
300 mm, 11 1/2"

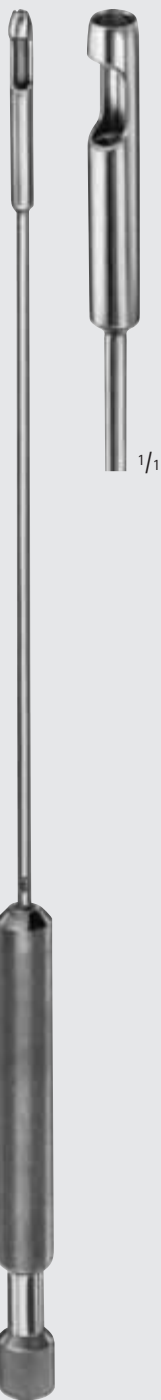

1/1

Ø  
diam.

**FO925R** 5 mm

Sehnenstripper  
Schaftlänge: 390 mm  
Tendon stripper  
Shaft length: 15 1/3"  
495 mm, 19 1/2"

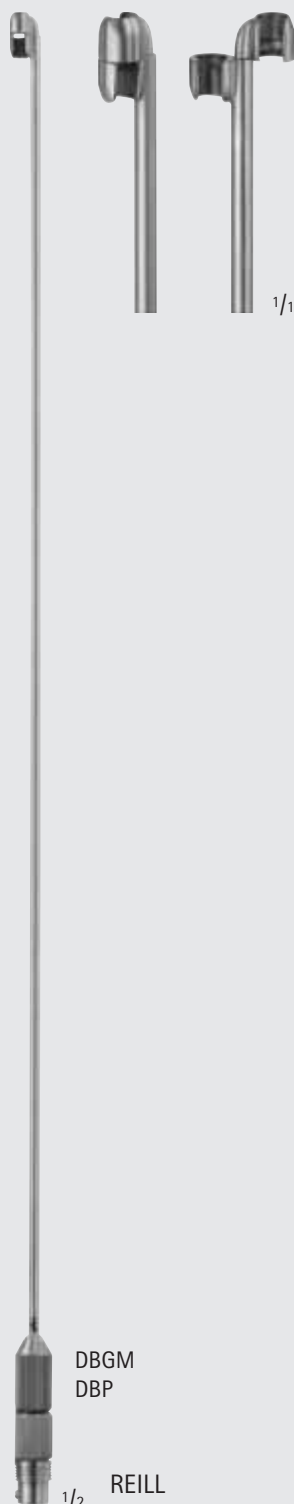

1/1

DBGM  
DBP

REILL

1/2

Ø  
diam.

**FO928R** 4 mm

**FO930R** 6 mm

Sehnenstripper  
Schaftlänge: 350 mm  
Tendon stripper  
Shaft length: 13 3/4"  
395 mm, 15 1/2"

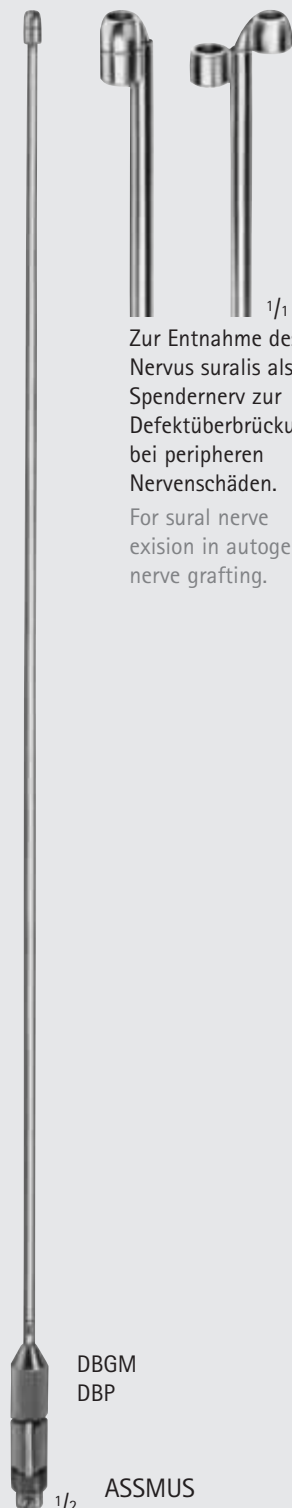

1/1

DBGM  
DBP

ASSMUS

1/2

Ø  
diam.

**FD610R** 3 mm

Nervenstripper, stumpf  
Schaftlänge: 350 mm  
Nerve stripper, blunt  
Shaft length: 13 3/4"  
395 mm, 15 1/2"

Zur Entnahme des  
Nervus suralis als  
Spendernerve zur  
Defektüberbrückung  
bei peripheren  
Nervenschäden.

For sural nerve  
exision in autogenous  
nerve grafting.



# Knochenhaltezangen, Hohlmeißelzangen – Bone Holding Forceps, Bone Rongeurs

Sehnenstripper  
Tendon Strippers

FO

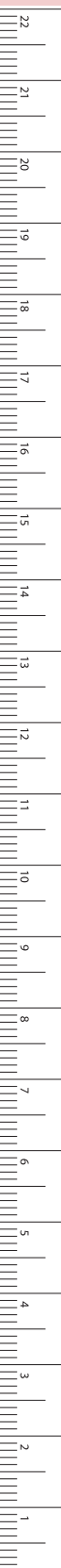

MILLIMETERS



FO931R FO932R FO933R FO934R <sup>1/1</sup>



BRUNNELL

Ø  
diam.

FO931R	2 mm
FO932R	3 mm
FO933R	4 mm
FO934R	6 mm

135 mm, 5 1/4"



FO935R

FO937R <sup>1/1</sup>

Ø  
diam.

FO935R	3 mm
FO937R	5 mm

300 mm, 12"

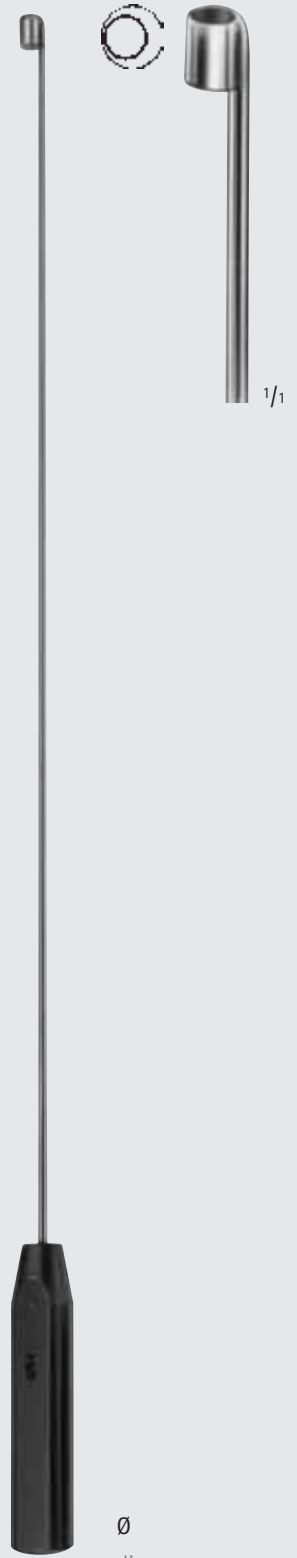

FO939R 5 mm

500 mm, 19 1/2"

Ø  
diam.

<sup>1/1</sup>

# Knochenhaltezangen, Hohlmeißelzangen – Bone Holding Forceps, Bone Rongeurs

Sehndurchziehsonden

Tendon Passing Probes

FO



1/2

**BUNNELL**

**FO940R**

230 mm, 9"



1/2

Knopf-Ø  
diam. of tip

**BN034R** 2,5 mm

145 mm, 5 3/4"



1/2

Knopf-Ø  
diam. of tip

**BN036R** 2,5 mm

160 mm, 6 1/4"



1/2

Knopf-Ø  
diam. of tip

**BN040R** 3,0 mm

200 mm, 8"

**Knochenhaltezangen, Hohlmeißelzangen – Bone Holding Forceps, Bone Rongeurs**  
 Bleihände, Handfixierplatte  
 Lead Hands, Hand Fixation Plate

**FO**

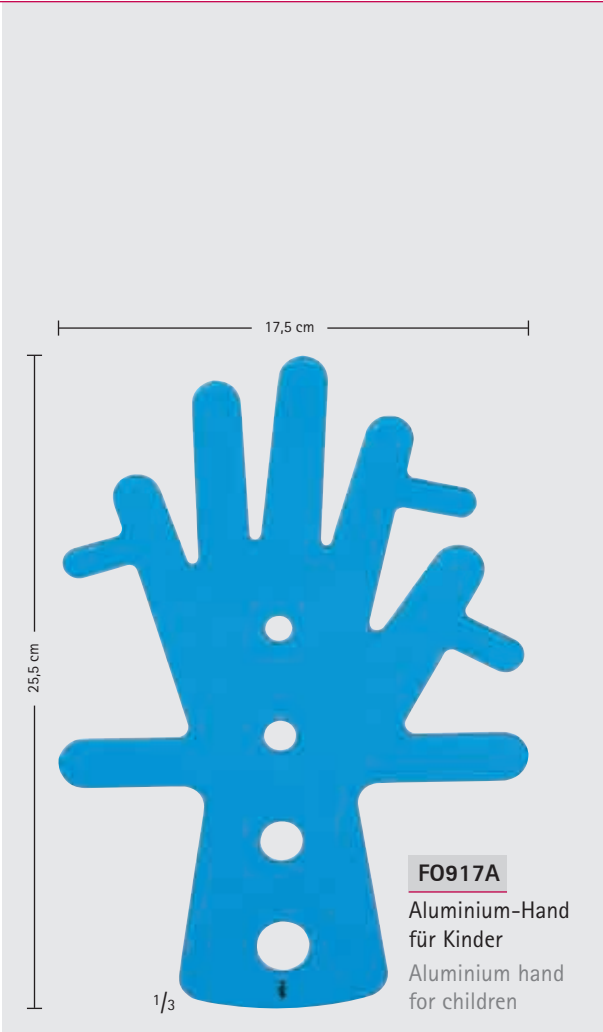



INCHES



LX



**Drahtextension, Handbohrapparate,  
Ahlen, Pfrieme**

Wire Extension, Hand Drills, Awls

## Drahtextension – Wire extension

Handbohrapparat  
Hand Drill



### FF057R

Verlängerungsstück allein  
Extension piece only

### FF056R

Bogen allein  
Brace only

### HUDSON

### FF055R

Handbohrapparat komplett,  
bestehend aus:

- FF056R Bogen
- FF057R Verlängerungsstück
- FF061R Fräser
- FF062R Fräser
- FF063R Fräser
- FF064R Fräser

Hand drill complete,  
consisting of:

- FF056R Brace
- FF057R Extension piece
- FF061R Burr
- FF062R Burr
- FF063R Burr
- FF064R Burr

Bohrer und Fräser auf dieser Seite passen auf FF056R und FF057R.  
**Achtung:** Nicht passend für den Handbohrapparat HUDSON DOWNS  
auf Seite 1053.

Perforators and burrs on this page fit onto FF056R and FF057R.  
**Attention:** Does not fit onto the hand drill HUDSON DOWNS  
on page 1053.

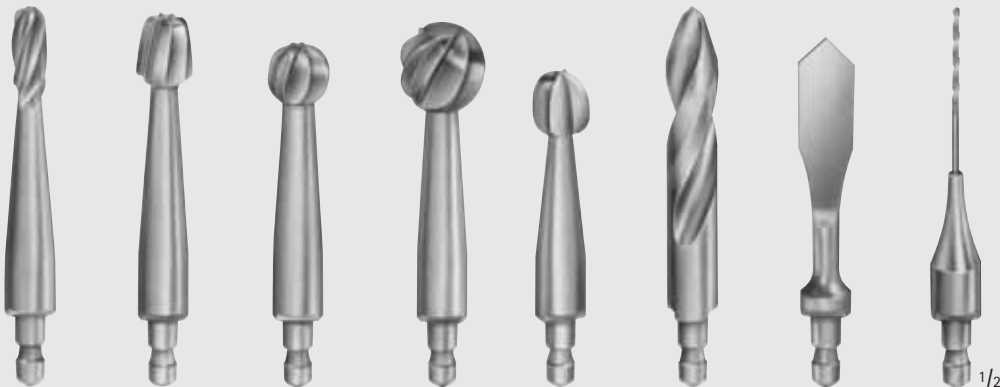

HUDSON

HUDSON

HUDSON

HUDSON

ADSON

MC KENZIE

CUSHING

FF061R

FF062R

FF063R

FF064R

FF065R

FF066R

FF067R

FF068R

Ø 9 mm

Ø 14 mm

Ø 16 mm

Ø 22 mm

Ø 15 mm

Ø 13 mm

Ø 14 mm

Ø 2 mm





**Drahtension – Wire extension**  
Handbohrapparat  
Hand Drill

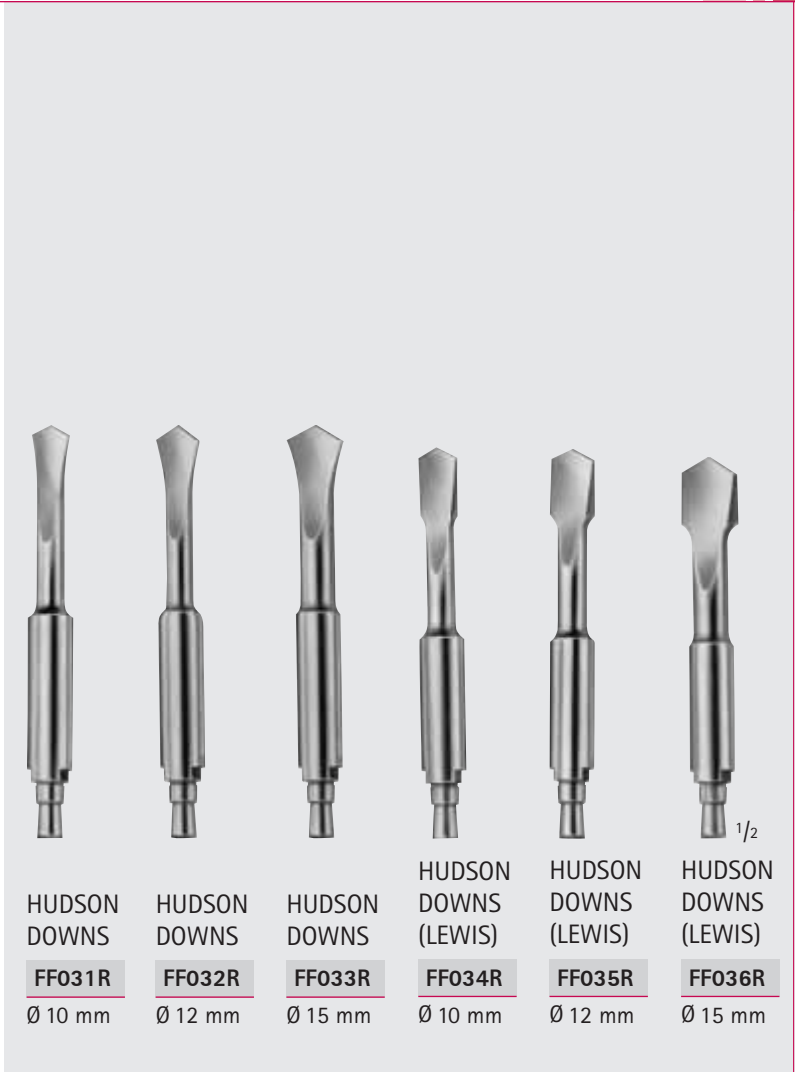

Bohrer und Fräser auf dieser Seite passen auf FF052R und FF053R.  
**Achtung:** Nicht passend für den Handbohrapparat HUDSON auf Seite 1052.

Perforators and burrs on this page fit FF052R and FF053R.  
**Attention:** Does not fit onto the hand drill HUDSON on page 1052.



X7



MILLIMETERS

## Drahtextension – Wire extension

### Handbohrapparate, Spiralbohrer

### Hand Drills, Twist Drills



BUNNELL

**FR005R**

Bohrapparat, kleines Modell, längsdurchbohrt, für Spickdrähte, mit 3-Backen-Spannfutter für Schäfte bis Ø 4,0 mm.

Small hand drill, cannulated for KIRSCHNER wires, with 3-jaw chuck, to fit any size of shanks up to 4.0 mm diameter

160 mm, 6 1/4"

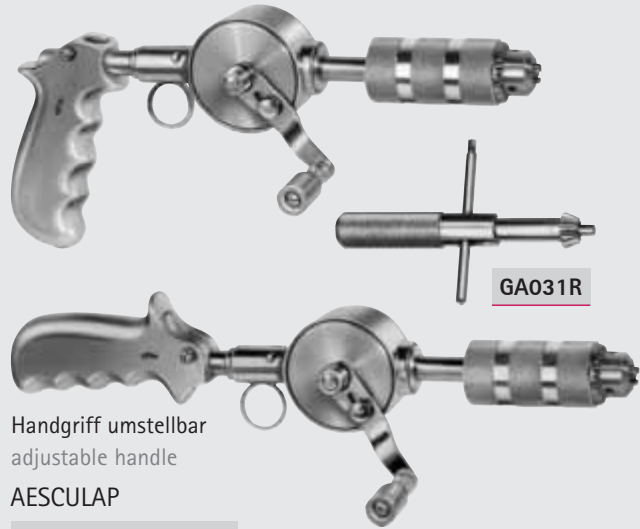

Handgriff umstellbar  
adjustable handle

AESCULAP

**FR011R**

Handbohrapparat, wie FR010R, jedoch mit Original "Jacobs Chuck" (3-Backen-Spannfutter) und Spannschlüssel GA031R, Bedienung mit und ohne Spannschlüssel möglich.

Hand drill, stainless, as FR010R, but equipped with an original "Jacobs Chuck" and key GA031R. Can be used with or without the key.

280 mm, 11"

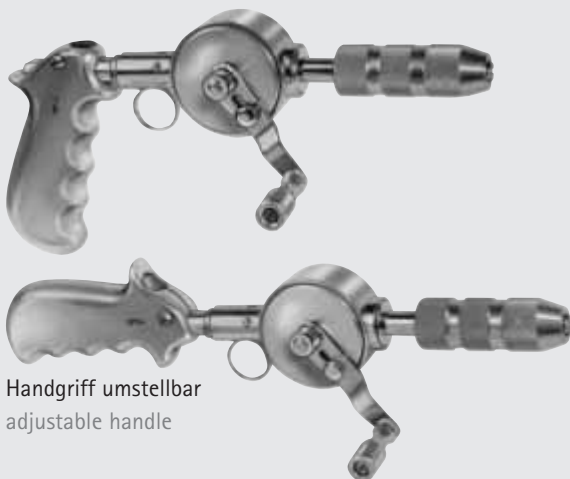

Handgriff umstellbar  
adjustable handle

AESCULAP

**FR010R**

Handbohrapparat, nichtrostend, mit schlüssellosem 3-Backen-Spannfutter für Schäfte bis Ø 6,35 mm.

Spindel ist längsdurchbohrt zum Einspannen von Bohrdrähten n. KIRSCHNER. Mit Stoppvorrichtung für Kurbel während dem Spannen.

Hand drill, stainless, with 3-jaw chuck, to fit any size of shanks up to 6.35 mm diameter, no key needed. Cannulated spindle to fit KIRSCHNER wire drills. With stop device, for locking the spindle and crank when fitting and changing drills.

260 mm, 10 1/4"

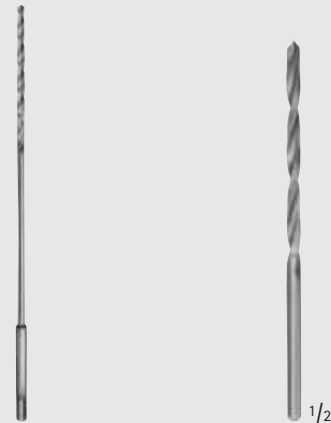

Ø diam	3-Kant-Schaft Triangular shaft	Länge* mm Length* mm	Rundschaft Round shaft	Länge* mm Length* mm
1,0 mm				
1,5 mm			<b>GC002R</b>	70/40 mm
2,0 mm			<b>GC004R</b>	100/50 mm
2,5 mm	<b>GC391R</b>	175/135 mm	<b>GC006R</b>	100/50 mm
2,8 mm			<b>GC007R</b>	100/50 mm
3,0 mm			<b>GC008R</b>	100/60 mm
3,2 mm			<b>GC009R</b>	100/60 mm
3,5 mm	<b>GC395R</b>	210/170 mm	<b>GC010R</b>	100/60 mm
4,0 mm			<b>GC012R</b>	110/70 mm
4,5 mm	<b>GC397R</b>	210/170 mm	<b>GC013R</b>	150/80 mm
5,0 mm			<b>GC014R</b>	160/90 mm
6,0 mm			<b>GC016R</b>	160/90 mm

\*Gesamtlänge/Nutzlänge

\*Total length/Usable length

LX





**Drahtension – Wire extension**  
Knochenbohrer, Ahlen  
Bone Drills, Awls

X1



CHAMPIONNIÈRE

**FR110R**

Knochenbohrer  
Bone drill  
170 mm, 6 3/4"

1/2



Ø 2,5 mm

Ø 3,5 mm

**FR118R**

Reibahle  
Reamer (Awl)  
150 mm, 6"

1/2

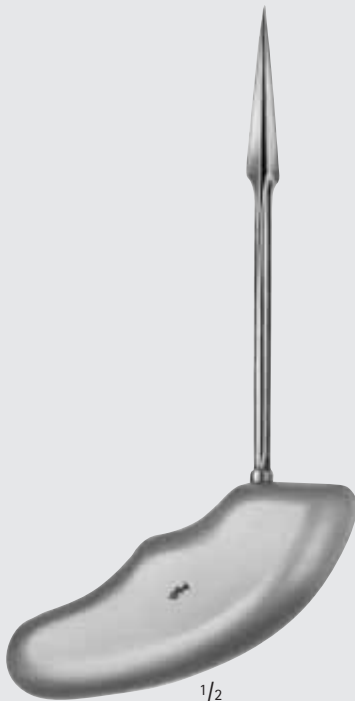

1/2

**FR120R**

Reibahle  
Reamer (Awl)  
180 mm, 7"



1/2

PERTHES

**FR125R**

Reibahle  
Reamer (Awl)  
215 mm, 8 1/2"

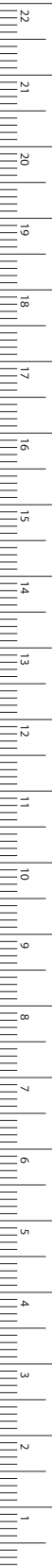

MILLIMETERS

## Drahtension – Wire extension

Unterbindungsnadeln

Ligature Needles

LX



OBWEGESER

**DO811R**

230 mm, 9"



OBWEGESER

**DO812R**

195 mm, 7 3/4"

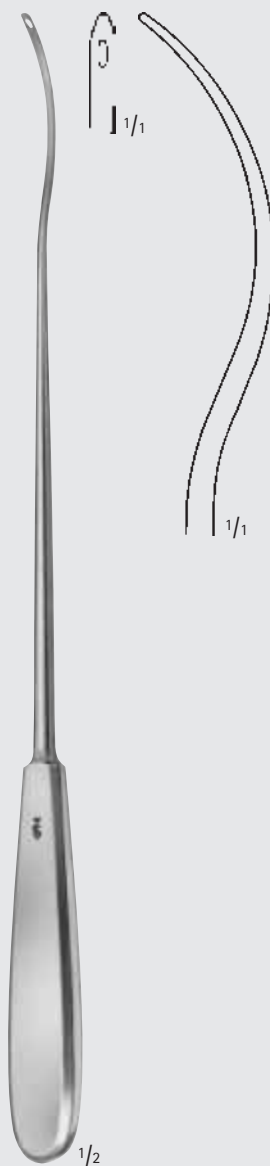

BRUNNER

**BM831R**

300 mm, 12"

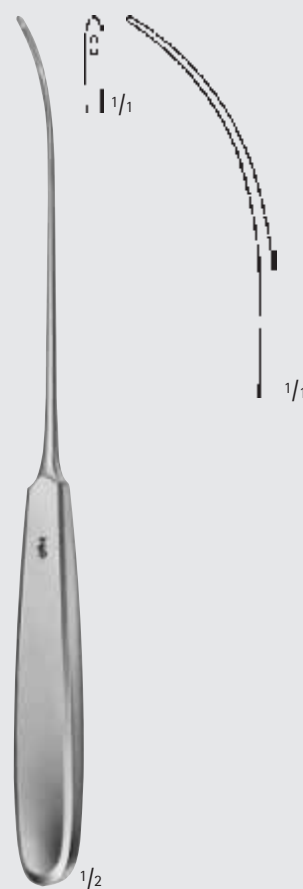

**BM861R**

biegsam  
malleable  
230 mm, 9"



## Drahtension – Wire extension

### Biopsie-Instrumente Biopsy Instruments

Auch sehr gut geeignet zum Freilegen von abgebrochenen Knochenschrauben.  
Can also be used for removal of broken bone screws.



**FR140R**

Innen-Ø 3,9 mm  
Außen-Ø 5 mm  
inside-diam. 3.9 mm  
outside-diam. 5 mm



**FR141R**

Innen-Ø 6,4 mm  
Außen-Ø 8 mm  
inside-diam. 6.4 mm  
outside-diam. 8 mm

**FR140R-FR141R**

Knochenbiopsie-Instrument  
Hollow mills (bone biopsy trephine)  
160 mm, 6 1/4"



1/1

Innen-Ø 6,7 mm  
Außen-Ø 8,7 mm  
inside-diam. 6.7 mm  
outside-diam. 8.7 mm

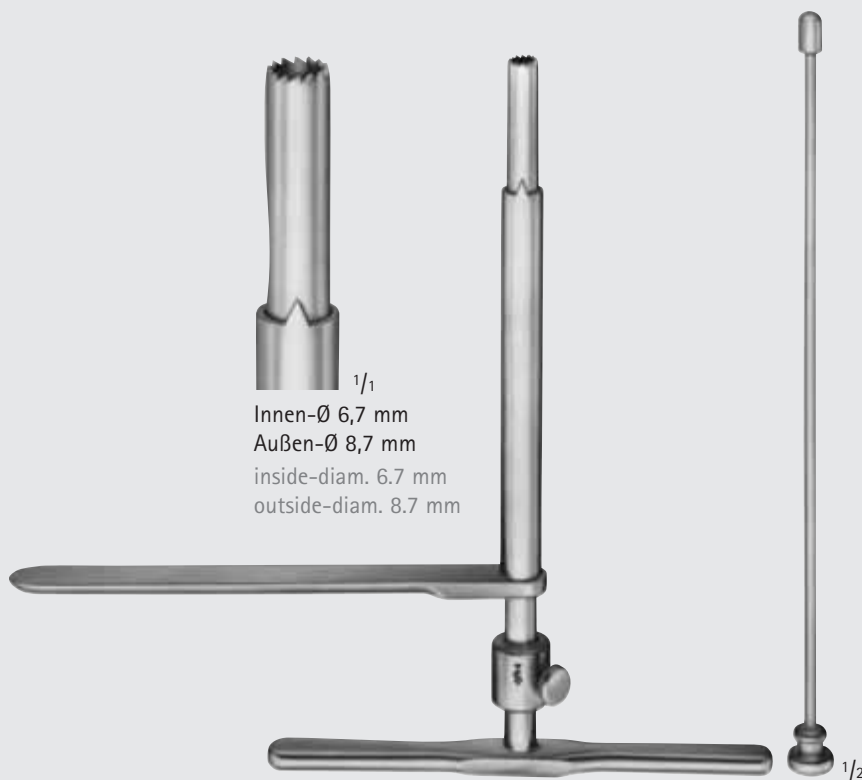

1/2

R.N.O.H.

**FR142R**

Knochenbiopsie-Instrument  
Bone biopsy trephine  
195 mm, 7 3/4"

X1

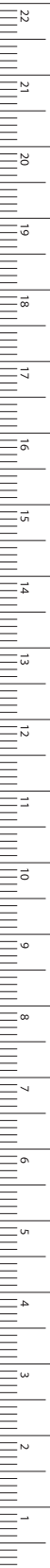

MILLIMETERS

## Drahtextension – Wire extension

Drahtextension  
Wire Extension

Implantatwerkstoff: Nichtrostender Stahl nach DIN 17 443  
bzw. ISO 5832/I (AISI 316 L)

Material used for implants: stainless steel acc. to DIN 17 443  
resp. ISO 5832/I (AISI 316 L)

mit beidseitiger  
Trokarspitze  
with trocar point  
on each end



KIRSCHNER

**LX901S-LX957S**

Ø diam.	102 mm 4"	127 mm 5"	152 mm 6"	229 mm 9"	305 mm 12"
0,8 mm	<b>LX901S</b>	<b>LX902S</b>			
0,9 mm	<b>LX911S</b>	<b>LX912S</b>	<b>LX913S</b>	<b>LX915S</b>	<b>LX917S</b>
1,0 mm					
1,1 mm	<b>LX921S</b>	<b>LX922S</b>	<b>LX923S</b>	<b>LX925S</b>	<b>LX927S</b>
1,2 mm					
1,4 mm					
1,5 mm					
1,6 mm	<b>LX951S</b>	<b>LX952S</b>	<b>LX953S</b>	<b>LX955S</b>	<b>LX957S</b>
1,7 mm					
1,8 mm					
2,0 mm					
2,2 mm					
2,5 mm					
3,0 mm					

mit Trokarspitze  
with trocar point



mit flachem Ende  
with flat shaft



KIRSCHNER

**LX008S-LX025S**

310 mm, 12"

Ø diam.	
0,8 mm	<b>LX008S</b>
0,9 mm	
1,0 mm	<b>LX010S</b>
1,1 mm	
1,2 mm	<b>LX012S</b>
1,4 mm	<b>LX014S</b>
1,5 mm	<b>LX015S</b>
1,6 mm	<b>LX016S</b>
1,7 mm	<b>LX017S</b>
1,8 mm	<b>LX018S</b>
2,0 mm	<b>LX020S</b>
2,2 mm	<b>LX022S</b>
2,5 mm	<b>LX025S</b>
3,0 mm	

mit Trokarspitze  
with trocar point



mit rundem Ende  
with round shaft



KIRSCHNER

**LX030S-LX047S**

Form nach DIN 58 823  
Type acc. to DIN 58 823  
310 mm, 12"

Ø diam.	
0,8 mm	<b>LX030S</b>
0,9 mm	
1,0 mm	
1,1 mm	
1,2 mm	<b>LX032S</b>
1,4 mm	<b>LX034S</b>
1,5 mm	<b>LX035S</b>
1,6 mm	<b>LX036S</b>
1,7 mm	
1,8 mm	<b>LX038S</b>
2,0 mm	<b>LX040S</b>
2,2 mm	<b>LX042S</b>
2,5 mm	<b>LX045S</b>
3,0 mm	<b>LX047S</b>

Bestelleinheit: **PAK** = Packung à 10 Stück  
Sales unit: Package of 10 pieces



## Drahtextension – Wire extension

### Drahtextension Wire Extension

Implantatwerkstoff: Nichtrostender Stahl nach DIN 17 443 bzw. ISO 5832/I (AISI 316 L)

Material used for implants: stainless steel acc. to DIN 17 443 resp. ISO 5832/I (AISI 316 L)

mit Trokarspitze  
with trocar point



mit rundem Ende  
with round shaft

**KIRSCHNER**

**LX098S-LX100S**

70 mm, 2 3/4"

Ø diam.	
0,8 mm	<b>LX098S</b>
1,0 mm	<b>LX100S</b>
1,2 mm	
1,4 mm	
1,5 mm	
1,6 mm	
1,7 mm	
1,8 mm	
2,0 mm	
2,2 mm	
2,5 mm	
3,0 mm	

mit Trokarspitze  
with trocar point



mit flachem Ende  
with flat shaft

**KIRSCHNER**

**LX108S-LX125S**

Form nach DIN 58 823  
Type acc. to DIN 58 823  
150 mm, 6"

Ø diam.	
0,8 mm	<b>LX108S</b>
1,0 mm	<b>LX110S</b>
1,2 mm	<b>LX112S</b>
1,4 mm	<b>LX114S</b>
1,5 mm	<b>LX115S</b>
1,6 mm	<b>LX116S</b>
1,7 mm	<b>LX117S</b>
1,8 mm	<b>LX118S</b>
2,0 mm	<b>LX120S</b>
2,2 mm	<b>LX122S</b>
2,5 mm	<b>LX125S</b>
3,0 mm	

mit Trokarspitze  
with trocar point

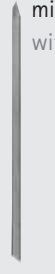

mit rundem Ende  
with round shaft

**KIRSCHNER**

**LX128S-LX146S**

Form nach DIN 58 823  
Type acc. to DIN 58 823  
150 mm, 6"

Ø diam.	
0,8 mm	<b>LX128S</b>
1,0 mm	<b>LX130S</b>
1,2 mm	<b>LX132S</b>
1,4 mm	<b>LX134S</b>
1,5 mm	<b>LX135S</b>
1,6 mm	<b>LX136S</b>
1,7 mm	<b>LX137S</b>
1,8 mm	<b>LX138S</b>
2,0 mm	<b>LX140S</b>
2,2 mm	<b>LX142S</b>
2,5 mm	<b>LX145S</b>
3,0 mm	<b>LX146S</b>

Biegeinstrumente  
für Bohrdrähte  
Bending iron for  
boring wires

Dampfsterilisierbar  
bis 143 °C (3 bar)  
Can be sterilized  
in a steam sterilizer  
up to 143 °C  
(3 bar)



**WAGNER**

**LX180S**

bis Ø 3,0 mm  
up to 3.0 mm  
diam.

300 mm, 12"



1/2

**LX175S**

bis Ø 2,7 mm  
up to 2.7 mm  
diam.

120 mm, 4 3/4"

Bestelleinheit: **PAK** = Packung à 10 Stück  
Sales unit: Package of 10 pieces

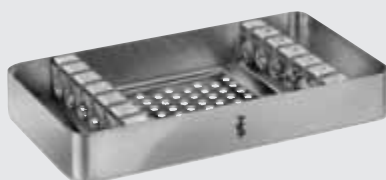

**LX002R** 170 x 92 x 25 mm

Sortiergestell für Fingerdrähte bis max. 165 mm Länge,  
mit Kontroll-Lehre und Unterteilungen für Drähte mit  
1,0 - 1,2 - 1,4 - 1,6 - 1,8 und 2,0 mm Ø.  
Sterilizing rack for finger wires up to max. 165 mm long,  
with measuring scale and compartments for wires with  
1.0, 1.2, 1.4, 1.6, 1.8 and 2.0 mm diam.

X1

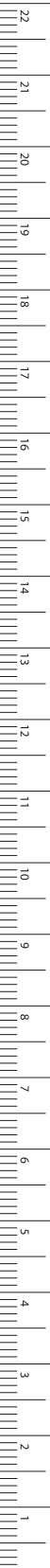

MILLIMETERS

## Drahtextension – Wire extension

Drahtextension

Wire Extension

SW17

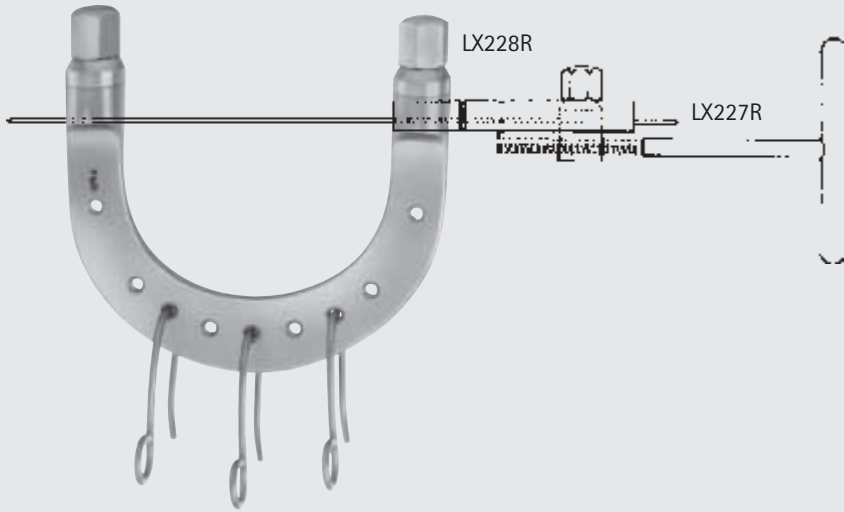

KIRSCHNER

**LX211R-LX218R**

Extensionsbügel, zur Verwendung mit KIRSCHNER-Drähten bis Ø 2,5 mm, mit 3 Zughaken, aus nichtrostendem Stahl  
Wire traction bows, to be used with KIRSCHNER-wires up to 2.5 mm diam., with 3 hooks, stainless steel

Lichte Maße

Inside dimensions

Weite

Width

Tiefe

Depth

LX211R	200 mm, 8"	155 mm, 6"	für die Hüfte	for the hip
LX212R	155 mm, 6"	155 mm, 6"	für den Oberschenkel	for the femur
LX213R	135 mm, 5 1/4"	130 mm, 5 1/8"	für das Knie	for the knee
LX214R	120 mm, 4 3/4"	120 mm, 4 3/4"	für das Knie	for the knee
LX215R	105 mm, 4 1/8"	100 mm, 4"	für das Knie	for the knee
LX216R	95 mm, 3 3/4"	110 mm, 4 3/8"	für das Fersenbein	for the calcaneus
LX218R	95 mm, 3 3/4"	70 mm, 2 3/4"	für den Arm und Ellenbogen	for the arm and elbow

SW17



SW14

**LX225C**

Spannschlüssel für Extensionsbügel LX211R - LX242R  
Wrench, double-ended, for wire traction bows LX211R - LX242R

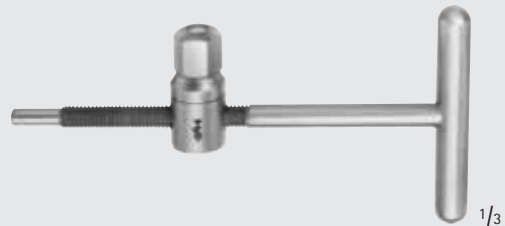

**LX227R**

Spannschlüssel mit Klemmbacke, zum Spannen des Drahtes  
Wire tightener with clamping jaws



1/2

**LX222R**

Zughaken allein, großes Modell  
Traction hook only, large size



1/2

**LX223R**

Zughaken allein, kleines Modell  
Traction hook only, small size



1/3

**LX228R**

Fixierschlüssel zum Festhalten der Klemmschraube am Spannschlüssel LX227R  
Fixation clamp, to secure clamping jaw of LX227R, stainless steel





## Drahtextension – Wire extension

### Drahtextension Wire Extension

X1

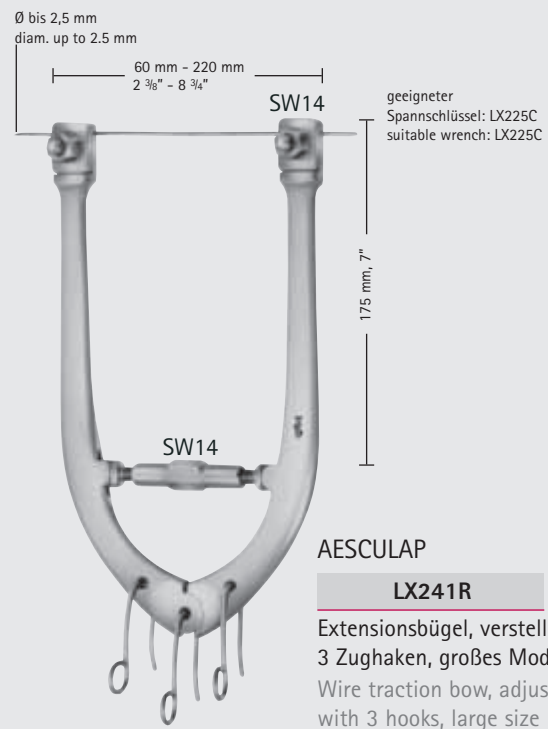
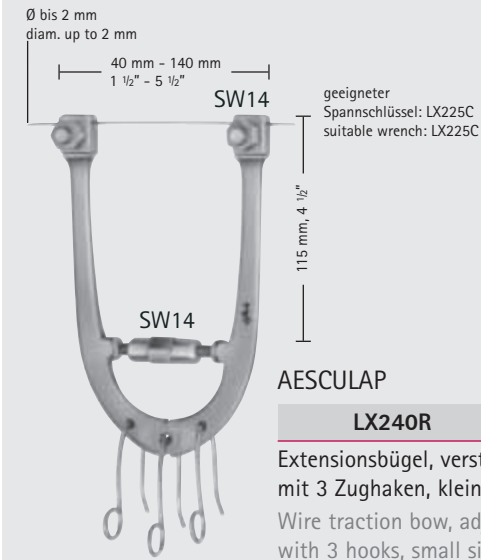

**LX265C**

Begrenzungsplatte mit Schlitz  
Fixation disc, slotted



**LX267R**

Fixierscheibe (Begrenzungsplatte)  
Fixation disc, slotted



**LX266**

Begrenzungsplatte mit Schlitz,  
röntgendurchlässig aus Aluminium  
Fixation disc, slotted idem, aluminium,  
transparent to X-rays



**LX269R**

Schraubenzieher für Fixierscheiben  
Screw driver for above fixation discs



## Drahtextension – Wire extension

Extensionsbügel, Distraktor

Traction Bows, Distractor



BÖHLER

**LX204R-LX209R**

Extensionsbügel,  
zur Verwendung von  
STEINMANN-Nägeln

Traction bows,  
to be used with  
STEINMANN pins

Ø diam. 4 mm		Ø diam. 5 mm		lichte Weite inside width	für for
<b>LX204R</b>	mit Nagel KX115S with pin KX115S			16 x 9 cm 6 1/4" x 3 1/2"	Arm arm
<b>LX205R</b>	ohne Nagel without pin	<b>LX235R</b>	ohne Nagel without pin	16 x 9 cm 6 1/4" x 3 1/2"	Arm arm
<b>LX206R</b>	mit Nagel KX118S with pin KX118S			21 x 11 cm 8 1/4" x 4 3/8"	Oberschenkel und Knie femur and knee
<b>LX207R</b>	ohne Nagel without pin	<b>LX237R</b>	ohne Nagel without pin	21 x 11 cm 8 1/4" x 4 3/8"	Oberschenkel und Knie femur and knee
<b>LX208R</b>	mit Nagel KX121S with pin KX121S			21 x 15 cm 8 1/4" x 6"	Oberschenkel und Knie femur and knee
<b>LX209R</b>	ohne Nagel without pin			21 x 15 cm 8 1/4" x 6"	Oberschenkel und Knie femur and knee

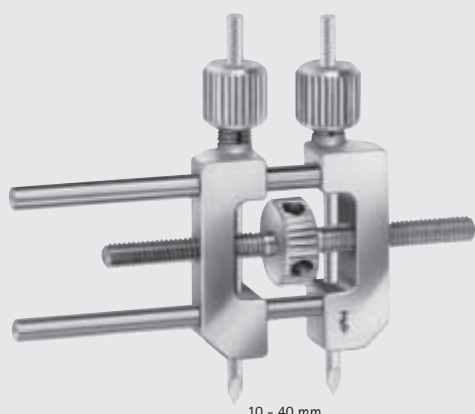

10 - 40 mm

**LX310R**

Kleiner Distraktor,  
zum Distrahieren und Komprimieren von  
kleinen Knochen, für Bohrdrähte Ø 3,0 mm

Small distractor,  
as a repositioning device for distraction and com-  
pression of small bones, for wires with 3.0 mm diam.



## Drahtension – Wire extension

### Nägel Pins

Implantatwerkstoff: Nichtrostender Stahl nach DIN 17 443  
bzw. ISO 5832/I (AISI 316 L)

Material used for implants: stainless steel acc. to DIN 17 443  
resp. ISO 5832/I (AISI 316 L)

X1



Länge length	Ø diam. 4 mm	Ø diam. 5 mm
80 mm	<b>KX108S</b>	
100 mm	<b>KX110S</b>	
120 mm	<b>KX112S</b>	
140 mm	<b>KX114S</b>	
150 mm	<b>KX115S</b>	<b>KX245S</b>
160 mm	<b>KX116S</b>	
180 mm	<b>KX118S</b>	<b>KX248S</b>
200 mm	<b>KX120S</b>	<b>KX250S</b>
210 mm	<b>KX121S</b>	
250 mm	<b>KX125S</b>	<b>KX255S</b>
300 mm		<b>KX260S</b>

STEINMANN

**KX108S-KX260S**

mit 3-Kant-Schaft und Trokarspitze  
Form C nach DIN 58 824

mit 3-Kant-Schaft und Trokarspitze  
Form C nach DIN 58 824

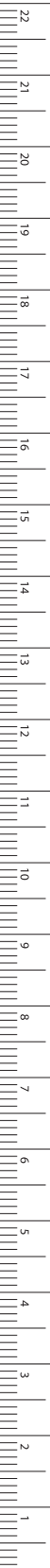

MILLIMETERS



1/1

**KX262**

Schutzkappe  
für STEINMANN-Nägel, Ø 4 mm  
Protection cap  
for STEINMANN pins, diam. 4 mm



1/1

**KX261**

Schutzkappe  
für STEINMANN-Nägel, Ø 5 mm  
Protection cap  
for STEINMANN pins, diam. 5 mm

## Drahtextension – Wire extension

### Handbohrfutter

### Drilling Chucks



1/2

#### FR105R

Handbohrfutter, längsdurchbohrt,  
Spannweite 0,8 - 2,0 mm Ø

Drilling chuck, cannulated,  
for shanks from  
0.8 mm - 2.0 mm diam.

150 mm, 6"



1/2

#### FR103R

Handbohrfutter, längsdurchbohrt,  
Spannweite bis 4,5 mm Ø, mit  
Spannschlüssel GA062R

Drilling chuck, cannulated, for shanks  
up to 4.5 mm diam., with key GA062R

140 mm, 5 1/2"

Spannbacken aus  
Implantatwerkstoff

Chuck jaws made of material  
used for implants



1/2

#### LX202S

Handbohrfutter, längsdurchbohrt,  
Spannweite bis 6,35 mm Ø,  
von Hand zu spannen

Drilling chuck, cannulated,  
for shanks up to 6.35 mm diam.,  
to be tightened by hand

100 mm, 4"



1/2

#### LX210R

Handbohrfutter, längsdurchbohrt,  
Spannweite bis 4,5 mm Ø und für  
3-Kant-Schaft SW 4,7 (SCHANZsche  
Schrauben, STEINMANN Nägel), mit  
Spannschlüssel GA062R

Drilling chuck, cannulated, for  
shanks up to 4.5 mm diam. and for  
triangular shaft width across flats  
4.7 mm (SCHANZ screws,  
STEINMANN pins), with key GA062R



1/2

#### LX203R

Handbohrfutter, längsdurchbohrt,  
Spannweite bis 6,35 mm Ø, mit  
Spannschlüssel GA031R

Drilling chuck, cannulated, for  
shanks up to 6.35 mm diam.,  
with key GA031R

160 mm, 6 1/4"



## Drahtextension – Wire extension

### Cerclage-Instrumente Cerclage Instruments



#### KY002S-KY015S

Draht, weich, gewebeverträglich, in Ringen zu 10 m

**Implantatwerkstoff:** Nichtrostender Stahl nach DIN 17 443 bzw. ISO 5832/I grade B (AISI 316 LVM)

Wire, soft, tissue compatible, in coils of 10 m

**Material used for implants:** stainless steel acc. to DIN 17 443 resp. ISO 5832/I grade B (AISI 316 LVM)

Ø	diam.	0,2 mm	0,3 mm	0,4 mm	0,5 mm	0,6 mm	0,7 mm	0,8 mm	0,9 mm	1,0 mm	1,2 mm	1,5 mm
		KY002S	KY003S	KY004S	KY005S	KY006S	KY007S	KY008S	KY009S	KY010S	KY012S	KY015S
Gauge		35	30	27	25	23	22	21	20	19	18	17



1/1

#### ORMROD-SCHMITT

#### KY100S

Ligaturplättchen

Ligature disc

**Implantatwerkstoff:** Nichtrostender Stahl nach DIN 17 443 bzw. ISO 5832/I grade B (AISI 316 LVM)

**Material used for implants:** stainless steel acc. to DIN 17 443 resp. ISO 5832/I grade B (AISI 316 LVM)



1/2

#### LOUTE

#### KY220S

Drahtspanner, verbessertes Modell, mit an der Spitze eingebauter beweglicher Drahtspannbuchse für Draht bis 1,0 mm Ø  
Wire tightener, improved pattern, with movable tip, for wires up to 1.0 mm diam.

220 mm, 8 3/4"

Spannbuchse aus **Implantatwerkstoff**, drehbar gelagerte Kopfscheibe.  
Die drehbar gelagerte Kopfscheibe dreht sich während des Quirlvorgangs nicht mit.  
Dadurch wird ein Abscheren des Cerclage-Drahts vermieden.  
Movable tip made of **material used for implants**.  
While twisting the movable head remains stable, therefore the wire will not slip off.



1/1

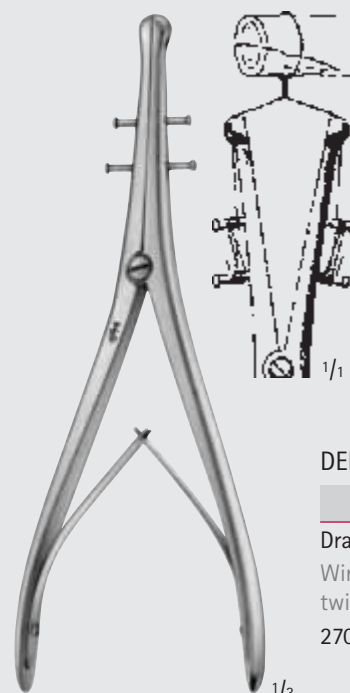

1/3

#### DEMEL

#### KY225R

Drahtspannzange  
Wire tightening- and twisting forceps  
270 mm, 10 3/4"

X1



MILLIMETERS

## Drahtextension – Wire extension

Cerclage-Instrumente

Cerclage Instruments

LX



DEMEL

**KY201R-KY203R**

Drahtumführungsnaedeln

Wire guides

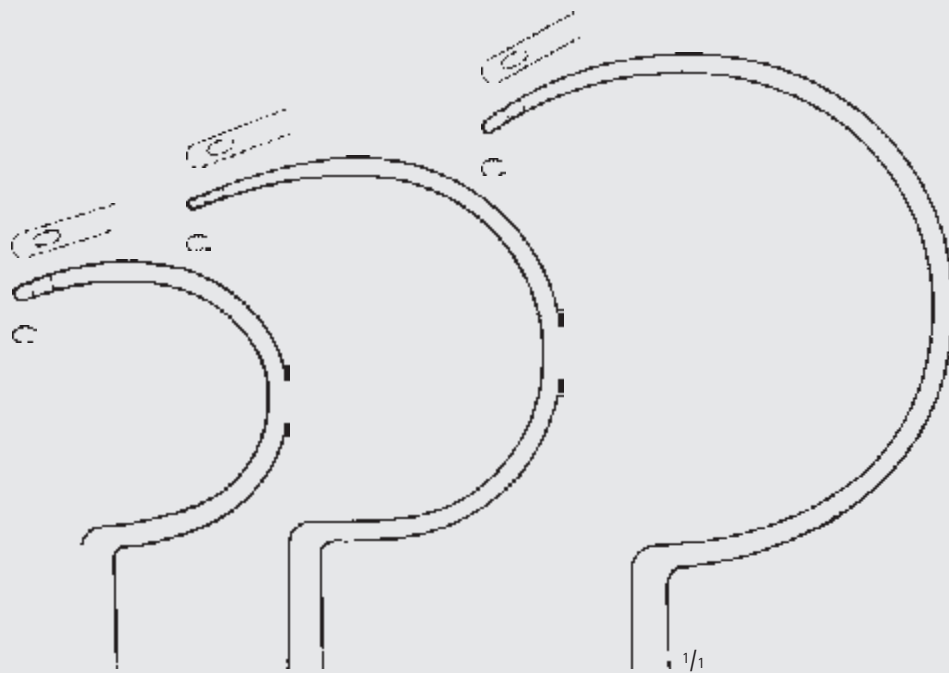

**KY201R**

275 mm

10 <sup>3</sup>/<sub>4</sub>"

**KY202R**

285 mm

11 <sup>1</sup>/<sub>4</sub>"

**KY203R**

305 mm

12"

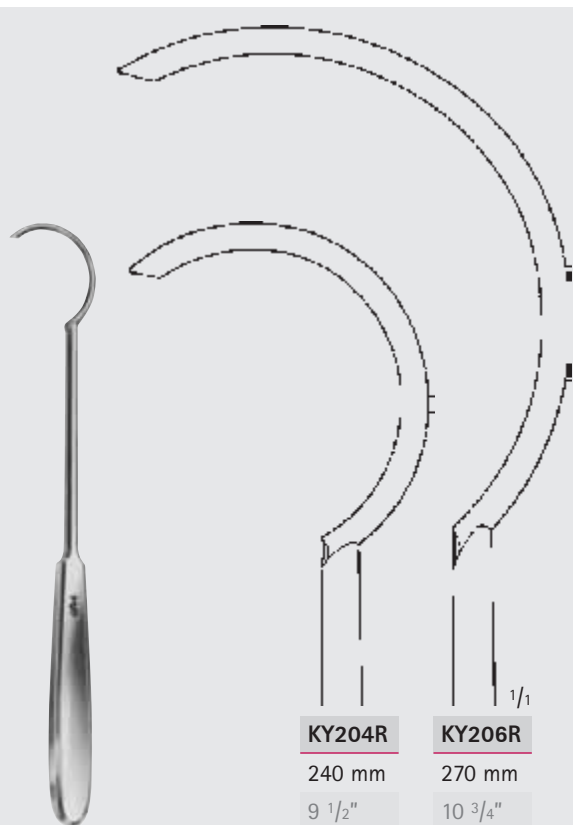

**KY204R**

240 mm

9 <sup>1</sup>/<sub>2</sub>"

**KY206R**

270 mm

10 <sup>3</sup>/<sub>4</sub>"

**KY204R-KY206R**



<sup>1</sup>/<sub>3</sub>

**KY205R**

225 mm, 9"



mit Hartmetallbacken



with hard metal inserts

## Drahtextension – Wire extension Drahtfasszangen, Drahtspannzangen Wire Holding Forceps, Wire Twisters

X1



**LX176R**

Drahtfasszange mit  
seitlichen Backen gegen  
Abrutschen des Drahtes  
Holding forceps for cerclage  
wire, with lateral jaws to  
avoid wire slipping off  
1/2 170 mm, 6 3/4"



**BM110R**

Drahtspannzange,  
Ligaturzange  
Wire twister,  
Ligature forceps  
150 mm, 6"



**BM111R**

Drahtspannzange,  
Ligaturzange  
Wire twister,  
Ligature forceps  
1/2 150 mm, 6"



**BAUMGARTNER**

**BM112R**

Drahtspannzange,  
Ligaturzange  
Wire twister,  
Ligature forceps  
1/2 200 mm, 8"

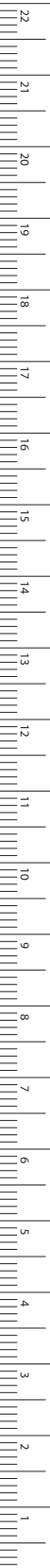

MILLIMETERS

**Drahtextension – Wire extension**  
 Drahtspannzangen, Drahtschneidezangen  
 Wire Twisters, Wire Cutting Scissors

mit Hartmetallbacken  
  
 with hard metal inserts

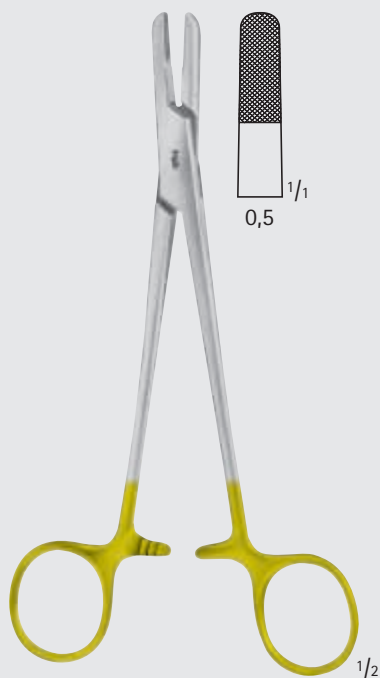

**BM113R**

für die Sternennaht  
 for sternum suture  
 175 mm, 7"



**BERRY**

**MD456R**

Drahtspannzange,  
 Ligaturzange  
 Wire twister, ligature forceps  
 185 mm, 7 1/4"



spezialvergütete  
**Schneiden**  
 specially hardened  
 cutting edges

**LX149R**

abgewinkelte schlanke Form zur Drahtentfernung  
 (für weichen Draht bis Ø 0,9 mm) nach Sternennaht  
 angled slender pattern for wire removal  
 (for soft wire up to diam. 0.9 mm) after sternum suture  
 170 mm, 6 3/4"

LX







## Drahtextension – Wire extension

Drahtfasszangen, Drahtspannzangen, Flachzangen  
Wire Holding Forceps, Wire Twisters, Flat-Nosed Pliers

X1

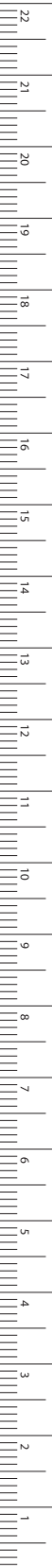

MILLIMETERS



MARBURG MODELL

**DP031R**

beidseitig kariert  
with serrated jaws  
140 mm, 5 1/2"



GOSLEE

**DP035R**

eine Seite kariert,  
eine Seite glatt  
one jaw smooth,  
one jaw serrated  
140 mm, 5 1/2"



**LX170R**

**LX171R**

**LX170R**

mit gerieften Backen  
with serrated jaws

**LX171R**

mit Längs- und Querrillen  
with longitudinal and  
transversal grooves  
170 mm, 6 3/4"



**LX172R**

190 mm, 7 1/2"

## Drahtextension – Wire extension

### Drahtfasszangen, Flachzangen

### Wire Holding Forceps, Flat-Nosed Pliers

Die als Fräsbacken gearbeiteten Maulenden ermöglichen es, Drahtenden freizulegen. Maulprofile gewährleisten absolut sicheres Fassen der Drahtenden.

Exposure of grown-in wire ends is possible due to milling ends of the jaws. Profiles of the jaws guarantee absolutely safe gripping of the wire ends.



**LX177R**

130 mm

5 1/8"

**LX178R**

180 mm

7"

**LX177R-LX178R**

Extraktionszangen für Bohrdrähte  
Extraction pliers for boring wires



**LX189R**

Parallel-Flachzange  
Flat-nosed pliers, parallel  
185 mm, 7 1/4"



**MB576R**

195 mm, 7 3/4"

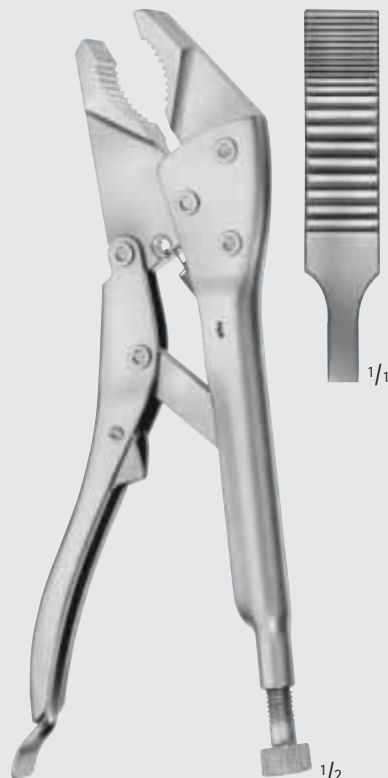

**LX174R**

Tonnenzange  
Vise grip  
200 mm, 8"

LX





## Drahtextension – Wire extension

Drahtfasszangen, Biegezangen

Wire Holding Forceps, Pliers for Bending and Cutting Wires

X1

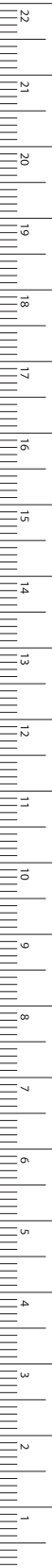

MILLIMETERS



**LX181R**

**LX181R**

180 mm

7"

Rundzange  
Round pliers



**LX185R**

145 mm

5 3/4"

Extraktionszangen für Bohrdrähte  
Extraction pliers for wires



**LX182R**

180 mm

7"



**LX183R**

180 mm

7"

**LX181R-LX185R**



**LX190R**

Biegezange für Spickdrähte bis 1,8 mm Ø  
Bending pliers for wires up to 1.8 mm diam.

**Drahtextension – Wire extension**  
 Drahtschneidezangen und -Scheren  
 Wire Cutters and Wire Cutting Scissors

LX



ANGLE

**DP540R**

130 mm, 5 1/8"

für weichen Draht bis Ø 0,5 mm  
 für harten Draht bis Ø 0,3 mm

for soft wire up to diam. 0.5 mm  
 for hard wire up to diam. 0.3 mm



**DP541R**

130 mm, 5 1/8"

0,6 mm  
 0,4 mm

0.6 mm  
 0.4 mm



**DP551R**

120 mm, 4 3/4"

für weichen Draht bis Ø 1,2 mm  
 für harten Draht bis Ø 0,6 mm

for soft wire up to diam. 1.2 mm  
 for hard wire up to diam. 0.6 mm

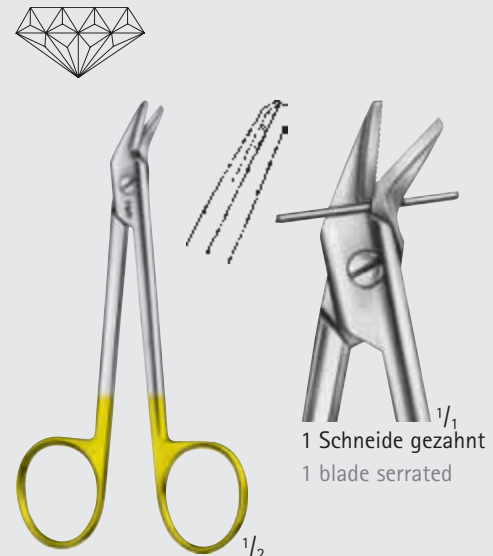

**DP552R**

120 mm, 4 3/4"

1,2 mm  
 0,8 mm

1.2 mm  
 0.8 mm



## Drahtextension – Wire extension

### Drahtschneidezangen und -Scheren

### Wire Cutters and Wire Cutting Scissors



<sup>1/1</sup>  
Schneiden gezahnt  
Blades serrated

HARVEY

**BC815R**

125 mm, 5"

für weichen Draht bis Ø  
für harten Draht bis Ø

0,4 mm  
0,3 mm

for soft wire up to diam.  
for hard wire up to diam.

0.4 mm  
0.3 mm



**DP501R**

150 mm, 6"

1,5 mm  
1,0 mm

1.5 mm  
1.0 mm



**DP505R**

160 mm, 6 1/4"

für weichen Draht bis Ø  
für harten Draht bis Ø

1,5 mm  
1,2 mm

for soft wire up to diam.  
for hard wire up to diam.

1.5 mm  
1.2 mm



spezialvergütete  
**Schneiden**  
specially hardened  
cutting edges

**DP530R**

140 mm, 5 1/2"

1,5 mm  
1,0 mm

1.5 mm  
1.0 mm

X7

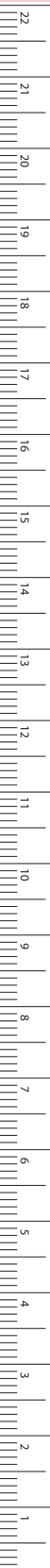

MILLIMETERS

**Drahtextension – Wire extension**  
 Drahtschneidezangen und Seitenschneider  
 Wire Cutters, Lateral Cutting Action

LX

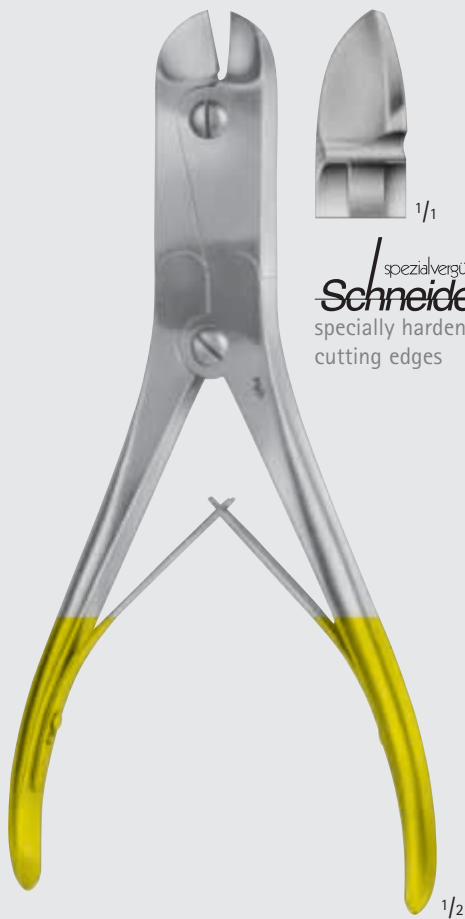
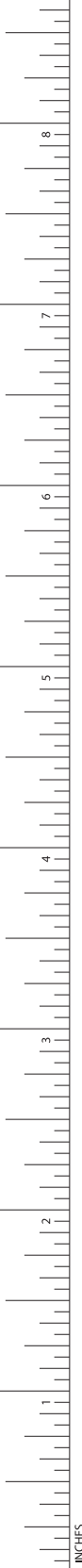

spezialvergütete  
**Schneiden**  
 specially hardened  
 cutting edges

**LX156R**

235 mm, 9 1/4"

für weichen Draht bis Ø	3,0 mm
für harten Draht bis Ø	2,2 mm

for soft wire up to diam.	3.0 mm
for hard wire up to diam.	2.2 mm



spezialvergütete  
**Schneiden**  
 specially hardened  
 cutting edges

**HARVEY**

**LX157R**

235 mm, 9 1/4"

3,0 mm
2,2 mm

3.0 mm
2.2 mm



## Drahtextension – Wire extension

### Drahtschneidezangen und Seitenschneider

#### Wire Cutters, Lateral Cutting Action

X1



#### LX149R

abgewinkelte schlanke Form zur Drahtentfernung nach Sternumnaht  
angled slender pattern for wire removal after sternum suture  
170 mm, 6 3/4"

für weichen Draht bis Ø 0,9 mm  
für harten Draht bis Ø -

for soft wire up to diam. 0.9 mm  
for hard wire up to diam. -



#### LX162R

240 mm, 9 1/2"

2,5 mm  
2,0 mm

2.5 mm  
2.0 mm

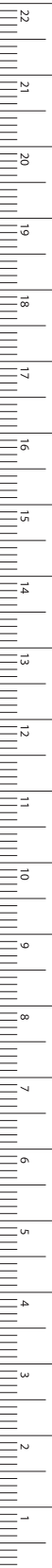

MILLIMETERS

**Drahtextension – Wire extension**  
 Drahtschneidezangen und Seitenschneider  
 Wire Cutters, Lateral Cutting Action

LX

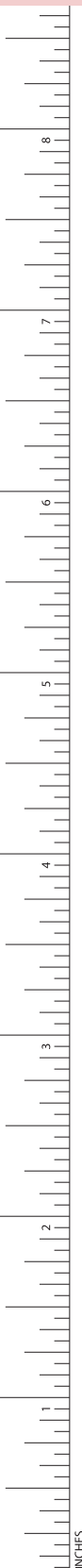

**LX158R**

Kopf- und Seitenschneider  
 Wire Cutters, front- and lateral cutting action  
 180 mm, 7"



**REILL**

**LX159R**

Schneiden gebogen, zum Abzwicken  
 direkt am Knochen  
 for cutting off wires close to the bone  
 175 mm, 7"

für weichen Draht bis Ø	2,0 mm
für harten Draht bis Ø	1,5 mm

for soft wire up to diam.	2.0 mm
for hard wire up to diam.	1.5 mm

2,0 mm
1,5 mm

2.0 mm
1.5 mm





**Drahtextension – Wire extension**  
 Drahtschneidezangen, Kopfschneider  
 Wire Cutters, Front Cutting Action

X1

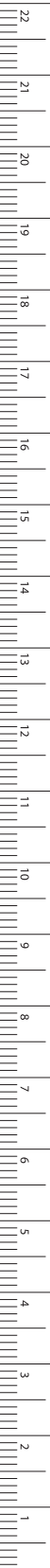

MILLIMETERS



spezialvergütete  
**Schneiden**  
 specially hardened cutting edges

**DP520R**  
 145 mm, 5 3/4"

für weichen Draht bis Ø 1,5 mm  
 für harten Draht bis Ø 1,0 mm

for soft wire up to diam. 1.5 mm  
 for hard wire up to diam. 1.0 mm



spezialvergütete  
**Schneiden**  
 specially hardened cutting edges

**LX150R**  
 145 mm, 5 3/4"

2,0 mm  
 1,5 mm

2.0 mm  
 1.5 mm



spezialvergütete  
**Schneiden**  
 specially hardened cutting edges

**LX152R**  
 220 mm, 8 3/4"

für weichen Draht bis Ø 3,0 mm  
 für harten Draht bis Ø 2,0 mm

for soft wire up to diam. 3.0 mm  
 for hard wire up to diam. 2.0 mm



spezialvergütete  
**Schneiden**  
 specially hardened cutting edges

**LX163R**  
 165 mm, 6 1/2"

3,5 mm  
 2,5 mm

3.5 mm  
 2.5 mm

## Drahtextension – Wire extension

Drahtschneidezangen

Wire Cutting Pliers

LX



### LX165R

Bolzenschneider zum Abzwicken von KIRSCHNER-Drähten, Tibia-Kopf-Schrauben und Nägeln bis zu 3 mm Ø

Cutter for cutting off KIRSCHNER wires, tibia head screws, bolts, pins, up to 3 mm diam.

320 mm, 12 3/4"



### LX164R

Bolzenschneider zum Abzwicken von KIRSCHNER-Drähten, Tibia-Kopf-Schrauben und Nägeln bis 6 mm Ø

Cutter for cutting off KIRSCHNER wires, tibia head screws, bolts, pins, up to 6 mm diam.

470 mm, 18 1/2"



## Drahtension – Wire extension

### Fingernagel-Instrumente Finger Nail Instruments

X7

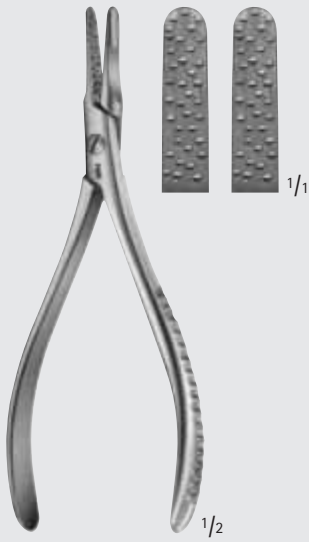

**FO903R**

Nagelausreibzange  
Nail extracting forceps  
135 mm, 5 1/2"

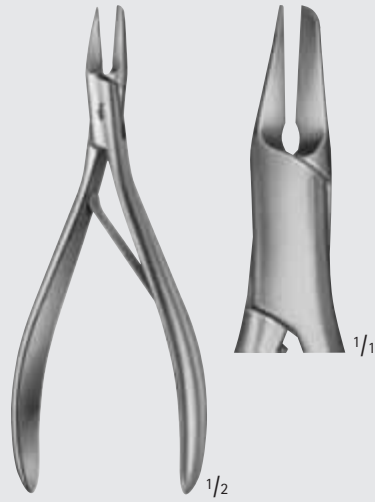

**HF266R**

Nagelspaltzange  
Nail splitting forceps  
130 mm, 5 1/8"



SYSTRUNK

**BC521R**

Schere für eingewachsene Nägel  
Scissors for splitting finger nails  
130 mm, 5 1/8"



**FO900R**

Fingerringssäge  
Finger ring saw  
150 mm, 6"



**FO901R**

Ersatz-Sägeblatt  
Spare blade



MILLIMETERS



INCHES

LX



**Gips-Instrumente**  
Plaster Instruments

## Gips-Instrumente – Plaster Instruments

Gips-Instrumente  
Plaster Instruments

LX



1/2

ESMARCH

**LX505R**

Gipsmesser  
Plaster knives  
180 mm, 7"



1/2

ENGEL

**LX522C**

Gipssäge  
Plaster saw  
150 mm, 6"



1/2

LISTER

**BC885R-BC977R**

<b>BC885R</b>	schwarz	black	<b>BC973R</b>	gelb	yellow
<b>BC970R</b>	rot	red	<b>BC975R</b>	orange	orange
<b>BC971R</b>	blau	blue	<b>BC977R</b>	pink	pink

Verband- und Erste-Hilfe-Scheren  
Bandage- and First Aid Scissors  
145 mm, 5 3/4"



2/3

**BC881R-BC987R**

<b>BC881R</b>	schwarz	black	<b>BC983R</b>	gelb	yellow
<b>BC980R</b>	rot	red	<b>BC985R</b>	orange	orange
<b>BC981R</b>	blau	blue	<b>BC987R</b>	pink	pink

Verband- und Erste-Hilfe-Scheren  
Bandage- and First Aid Scissors  
180 mm, 7"



## Gips-Instrumente – Plaster Instruments

Gipsscheren  
Plaster Scissors

X1



**LX548R**

für kleine Gipsverbände  
for small plaster dressings  
160 mm, 6 1/4"



**ESMARCH**

**LX550R** 200 mm 8"

**LX552R** 230 mm 9"



**BERGMANN**

**LX553R**

230 mm, 9"



MILLIMETERS

## Gips-Instrumente – Plaster Instruments

Gipsscheren

Plaster Scissors

LX



BRUNS

**LX556R**

235 mm, 9 1/4"



**LX558R**

auch als Kleiderschere verwendbar  
also to be used as bandage scissors  
235 mm, 9 1/4"



SEUTIN

**LX565R**

auch als Kleiderschere verwendbar  
also to be used as bandage scissors  
230 mm, 9"





## Gips-Instrumente – Plaster Instruments

### Gipsscheren Plaster Shears

#### Besondere Vorteile:

- Die Konstruktion des offenen Kastens verhindert das lästige Verstopfen durch Gipsreste, außerdem ist eine leichte Reinigung der Backen möglich.
- Die tiefe Zahnung an den Backen verhindert das Abgleiten der Gipsschere vom Gips.
- Die Messer, mit Hohlschliff, weisen eine bessere Schnitffähigkeit auf, daher geringerer Kraftaufwand.
- Messerführung durch Kugellager.

#### Special features:

- The construction of the open jaws avoids tiresome clogging by plaster remnants and allows furthermore an easy cleaning.
- The shears do not glide off the plaster owing to the deep teething on the jaws.
- The knives with hollow grinding have a better cutting ability and therefore less force is required.
- The knives are guided by ball bearings.

Kastenteil offen

open jaws



STILLE-AESFULAP

LX574R

260 mm, 10 1/4"



STILLE-AESFULAP

LX575R

360 mm, 14 3/8"

X1

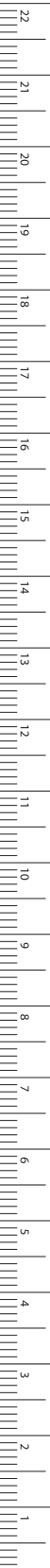

MILLIMETERS

## Gips-Instrumente – Plaster Instruments

Gipsscheren

Plaster Shears

LX



STILLE

**LX582R**

230 mm, 9"



STILLE

**LX587R**

Messer mit verstärktem Rücken  
Blade with reinforced back  
370 mm, 14 2/3"



## Gips-Instrumente – Plaster Instruments

Gipsspreizer, Gipsabreißzangen  
Plaster Spreader, Plaster Breakers

X1

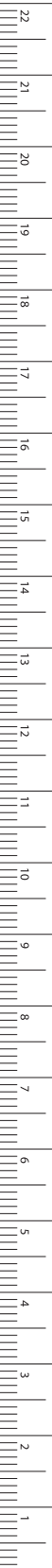

MILLIMETERS



1/3

HENNIG

**LX600R**

270 mm, 10 3/4"



1/3

MOD.USA

**LX605R**

230 mm, 9"



1/3

**LX610R**

290 mm, 11 1/2"



1/1

mit abnehmbaren Backen  
with removable jaws



1/2

WOLFF

**LX618R** 180 mm 7"

**LX624R** 240 mm 9 1/2"

Gipsabreißzangen (Rabenschnabel)  
Plaster breakers



INCHES

GF



Sauginstrumente  
Suction Instruments

## Sauginstrumente – Suction Instruments

Vakuümküretten

Vacuum Curettes



Kanülen zur Vakuümkürettage mit Graduierung und Saugunterbrecher

Curettes with graduation and suction interrupter, for vacuum curettage

Ø diam.

4 mm (zur Saugbiopsie geeignet)  
(suitable for suction biopsy)

**GF704R**

**GF706R**

**GF708R**

**GF710R**

**GF712R**

**GF714R**

6 mm

8 mm

10 mm

12 mm

14 mm



**GF719R**

Schlauchansatz, gerade  
Innen-Ø: 11 mm

Hose connection, straight  
inside diam.: 11 mm



**GF720R**

Schlauchansatz, gebogen  
Innen-Ø: 11 mm

Hose connection, curved  
inside diam.: 11 mm

Die Verbindung zwischen Saugküretten und Schlauchansatz GF720R gewährleistet schnelles Wechseln und freies Drehen der Saugküretten auf dem Schlauchansatz.

The connection between suction curette and hose connection GF720R guarantees quick changing and free turning of the suction curettes on the hose connection.

**GF721**

Saugschlauch, transparent, 1,8 m lang, Innen-Ø 11 mm, Außen-Ø 16,5 mm, sterilisierbar im Autoklav bei 143 °C (3 bar)

Transparent suction hose, 1.8 m long, inside diam. 11 mm, outside diam. 16.5 mm, can be sterilized in an autoclave at 143 °C (3 bar)



**GF722**

Gewebe-Auffangsieb aus Kunststoff, zum Einmalgebrauch für die histopathologische Untersuchung.

Strainer for tissue, plastic, for single use only, to be used for histopathological examination.



## Sauginstrumente – Suction Instruments

Sauginstrumente  
Suction Instruments

GF

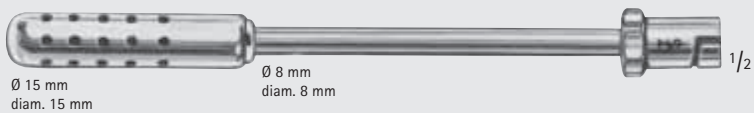

Ø 15 mm  
diam. 15 mm

Ø 8 mm  
diam. 8 mm

1/2

### GF805C

zum Ableiten großer Flüssigkeitsmengen  
for clearing large quantities of fluid  
190 mm, 7 1/2"



1/2

### GF806C

Trocar, zum Punktieren  
Trocar, for puncturing  
170 mm, 6 3/4"



1/2

### GF809C

doppelt gebogen, für Allgemein-Chirurgie  
double curved, for general surgery  
230 mm, 9"

mit Renk-Verschluß  
passend auf den Sauggriff  
GF801C

with bayonet fitting to be  
used with suction handle  
GF801C



MILLIMETERS

## Sauginstrumente – Suction Instruments

Sauginstrumente

Suction Instruments

GF



Olive Ø 8 mm  
olive diam. 8 mm

### GF801C

Sauggriff mit Vakuum-Regulierung und Unterbrecher,  
Messing hochglanzverchromt

Suction handle, with vacuum regulator and finger  
cut-off, brass, mirror-finish chromium-plated

150 mm, 6"

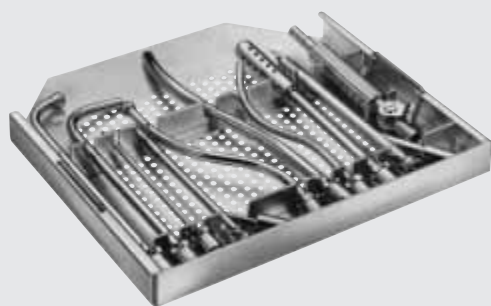

### GF841

Alu-Lagerungsrack allein, ohne Instrumente,  
passend in Basis Container, bestehend aus  
Bodenteil JK339 und Deckel JK399

Aluminium rack only, without instruments,  
fitting into Basis Container, consisting of  
container body JK339 and lid JK399

265 x 250 x 30 mm

INCHES





## Sauginstrumente – Suction Instruments

Sauginstrumente  
Suction Instruments

GF



Ø 9 mm  
diam. 9 mm

### GF816C

Universal-Kanüle, doppelt gebogen  
Universal cannula, double curved  
230 mm, 9"

Olive Ø 9 mm  
olive diam. 9 mm



▲  
Ø 7 mm  
Charr. 21

POOL

### GF860R

Saugkanüle mit abschraubbarem Außenrohr  
Suction cannula, with outer tube to be screwed off  
225 mm, 9"

1/2  
Olive Ø 6,5 - 9,5 mm  
olive diam. 6.5 - 9.5 mm



▲  
Ø 10 mm  
Charr. 30

POOL

### GF862R

Saugkanüle mit abschraubbarem Außenrohr  
Suction cannula with outer tube to be screwed off  
225 mm, 9"

1/2  
Olive Ø 8 - 10,5 mm  
olive diam. 8 - 10.5 mm



Ø 10 mm  
diam. 10 mm

YANKAUER

### GF944R

mit zentraler Bohrung, Ø 2,0 mm  
with central bore, 2.0 mm diam.  
285 mm, 11 1/4"

1/2  
Olive Ø 7 - 9 mm  
olive diam. 7 - 9 mm



MILLIMETERS

## Sauginstrumente – Suction Instruments

Sauginstrumente  
Suction Instruments

GF

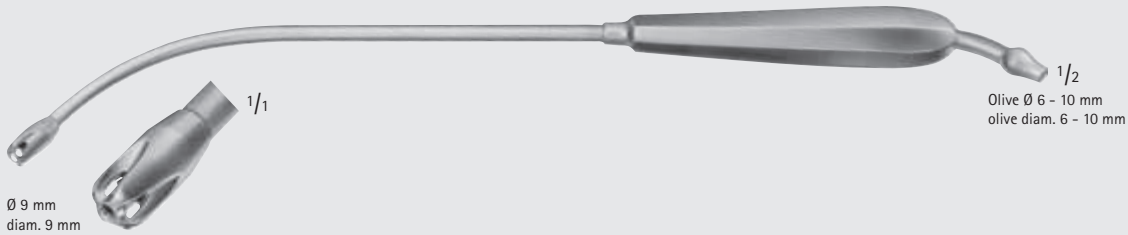

DE BAKEY

**GF946R**

mit zentraler Bohrung, Ø 3,0 mm und seitlichen Schlitzen

with central bore, 3.0 mm diam. with lateral slots

275 mm, 10 3/4"

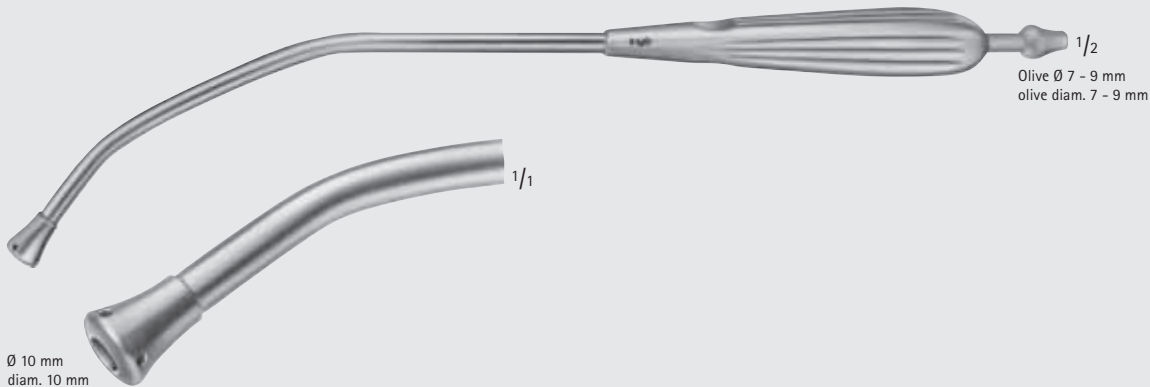

YANKAUER

**OM671R**

mit besonders großer zentraler Bohrung, Ø 4,8 mm

with especially large central bore, 4.8 mm diam.

285 mm, 11 1/4"

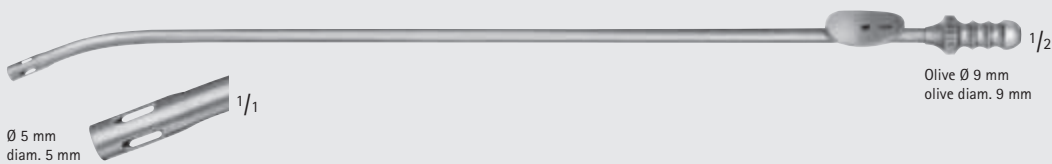

DE BAKEY

**GF948R**

mit Saugunterbrecher und Mandrin

with finger cut-off and stylet

270 mm, 10 3/4"

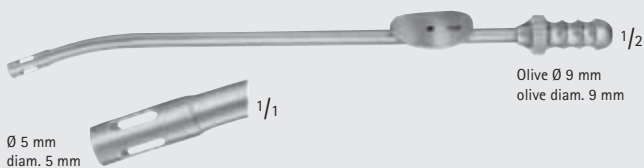

DE BAKEY

**GF947R**

mit Saugunterbrecher und Mandrin

with finger cut-off and stylet

160 mm, 6 1/4"

INCHES

# Sauginstrumente – Suction Instruments

## Sauginstrumente

## Suction Instruments

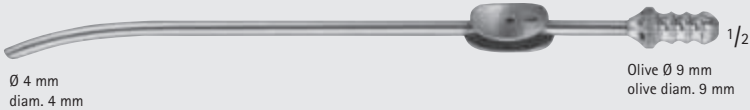
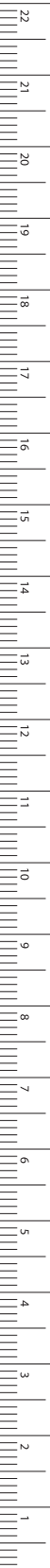

Ø 4 mm  
diam. 4 mm

Olive Ø 9 mm  
olive diam. 9 mm

ADSON

**GF917R**

mit Saugunterbrecher  
with finger cut-off  
190 mm, 7 1/2"

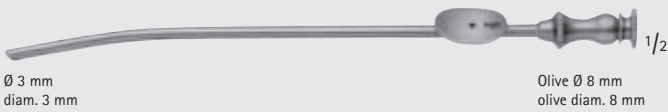

Ø 3 mm  
diam. 3 mm

Olive Ø 8 mm  
olive diam. 8 mm

ADSON

**GF918R**

mit Saugunterbrecher und Mandarin  
with finger cut-off and stylet  
165 mm, 6 1/2"

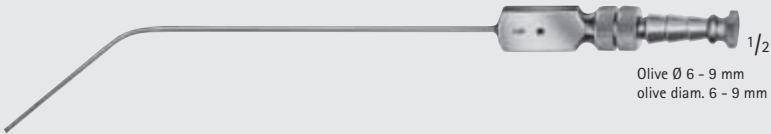

Olive Ø 6 - 9 mm  
olive diam. 6 - 9 mm

PLESTER

mit Saugunterbrecher und Mandarin,  
Griffplatte parallel zur Biegung, LUER-Bohrung  
with finger cut-off and stylet, thumb piece  
parallel to curve, with LUER hub  
195 mm, 7 3/4"

	Ø diam.
<b>GF939R</b>	1,5 mm
<b>GF940R</b>	2,0 mm
<b>GF941R</b>	2,5 mm
<b>GF942R</b>	3,0 mm
<b>GF355R</b>	5,0 mm

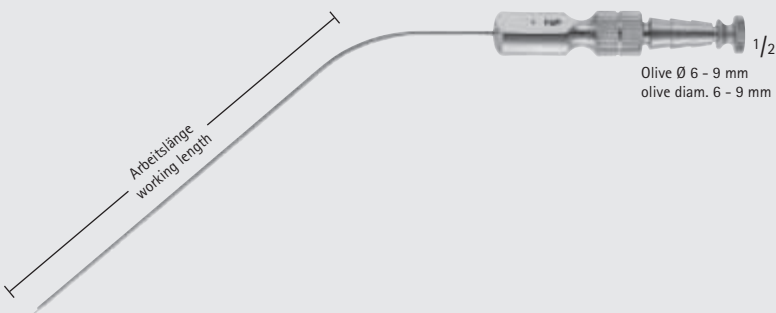

Olive Ø 6 - 9 mm  
olive diam. 6 - 9 mm

FERGUSSON

mit Saugunterbrecher und Mandrin,  
Griffplatte 90° zur Biegung, LUER-Bohrung  
with finger cut-off and stylet, thumb piece  
90° to curve, with LUER hub  
180 mm, 7"

	diam. Ø
<b>GF350R</b>	1,5 mm
<b>GF351R</b>	2,0 mm
<b>GF352R</b>	2,5 mm
<b>GF353R</b>	3,0 mm
<b>GF354R</b>	4,0 mm

## Sauginstrumente – Suction Instruments

Sauginstrumente  
Suction Instruments



Olive Ø 6 - 9 mm  
olive diam. 6 - 9 mm

FERGUSSON

**GF933R** Ø diam. 4,0 mm

isoliert, mit Saugunterbrecher und Mandrin,  
Griffplatte 90° zur Biegung, LUER-Bohrung

isolated, with finger cut-off and stylet,  
thumb piece 90° to curve, with LUER hub

180 mm, 7"



Olive Ø 6 - 9 mm  
olive diam. 6 - 9 mm

FRAZIER

Ø	diam.

**GF923R** 3,0 mm

**GF925R** 5,0 mm

mit Saugunterbrecher und Mandrin,  
Griffplatte 90° zur Biegung, LUER-Bohrung

with finger cut-off and stylet, thumb  
piece 90° to curve, with LUER hub

180 mm, 7"



FRAZIER

Ø	diam.

**MD124R** 2,3 mm

**MD125R** 2,7 mm

**MD127R** 3,4 mm

**MD129R** 4,0 mm

mit Saugunterbrecher und Mandrin,  
Griffplatte 90° zur Biegung, LUER-Bohrung  
with finger cut-off and stylet, thumb piece 90°  
to curve, with LUER hub

110 mm, 4 1/4"



## Sauginstrumente – Suction Instruments

### Sauginstrumente

### Suction Instruments

GF

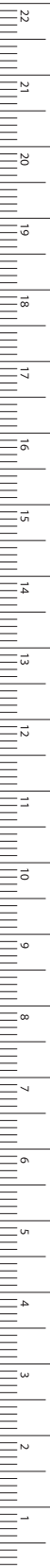

LEMPERT

Ø  
diam.

**GF937R** 2,0 mm

**GF938R** 3,0 mm

mit Saugunterbrecher und Mandrin  
with finger cut-off and stylet  
200 mm, 8"

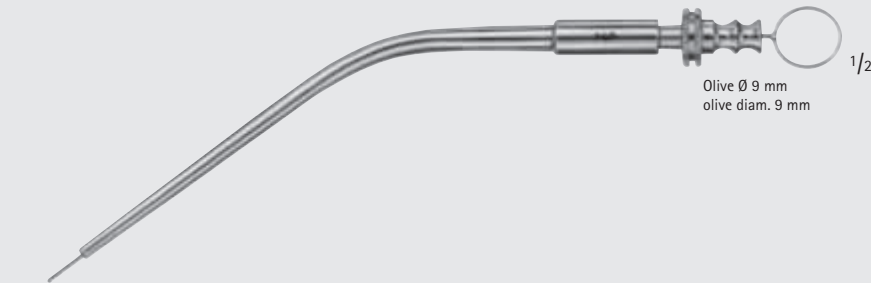

FORMBY

Ø  
diam.

**GF932R** 3,3 mm

210 mm, 8 1/4"



BARRON

Ø  
diam.

**GF935R** 1,3 mm

**GF936R** 2,0 mm

mit Saugunterbrecher und Mandrin  
with finger cut-off and stylet  
160 mm, 6 1/4"

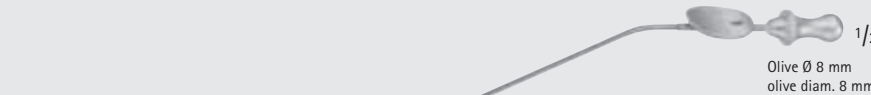

SCHUHKNECHT

Ø      Ø  
diam.   diam.

**GF756R** 20 swg    1,0 mm

**GF757R** 24 swg    0,5 mm

Saugkanülen  
Suction cannulae  
130 mm, 5 1/8"

MILLIMETERS

## Sauginstrumente – Suction Instruments

Sauginstrumente  
Suction Instruments

GF

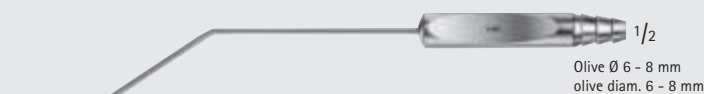

WULLSTEIN

**OG960R**

Mikro-Absaugrohr komplett, bestehend aus:

Micro suction tube, complete, consisting of:

<b>OG961R</b>	Absaugrohr mit LUER-Bohrung	Suction tube with LUER hub
<b>OG962R</b>	Mikro-Saugkanüle, Ø 0,4 mm	Micro suction cannula, 0.4 mm diam.
<b>OG963R</b>	Mikro-Saugkanüle, Ø 0,6 mm	Micro suction cannula, 0.6 mm diam.
<b>OG964R</b>	Mikro-Saugkanüle, Ø 0,8 mm	Micro suction cannula, 0.8 mm diam.

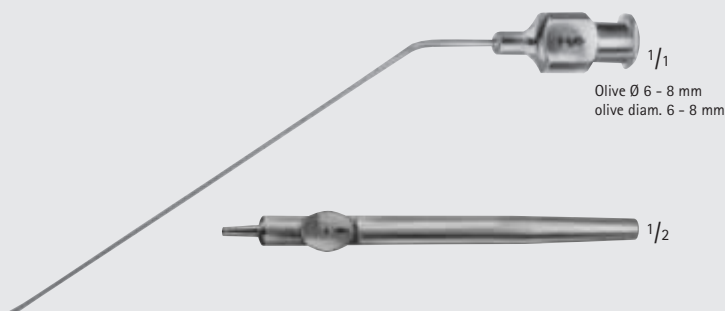

**OG970R**

Saugset komplett, bestehend aus:

Suction set, complete, consisting of:

<b>OG971R</b>	Saughandgriff mit LUER-Konus, mit Unterbrecher	Suction handle, with finger cut-off, with LUER cone
<b>OG972R</b>	2 Saugkanülen, Ø 0,5 mm, mit LUER-Konus	2 suction cannulae, 0.5 mm diam., with LUER cone
<b>OG973R</b>	2 Saugkanülen, Ø 0,7 mm, mit LUER-Konus	2 suction cannulae, 0.7 mm diam., with LUER cone
<b>OG974R</b>	2 Saugkanülen, Ø 1,0 mm, mit LUER-Konus	2 suction cannulae, 1.0 mm diam., with LUER cone
<b>OG969R</b>	2 Saugkanülen, Ø 1,3 mm, mit LUER-Konus	2 suction cannulae, 1.3 mm diam., with LUER cone

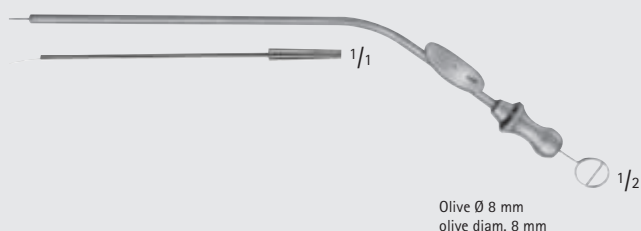

BELLUCCI

**OG950R**

Saugset komplett, bestehend aus:

Suction set, complete, consisting of:

<b>OG951R</b>	Saugrohr allein, mit Saugunterbrecher und Mandrin	Suction tube with finger cut-off and stylet	155 mm, 6"
<b>GF772R</b>	Saugkanüle Ø 20 swg., Ø 1,0 mm	Detachable end, 20 swg. diam., 1.0 mm diam.	
<b>GF773R</b>	Saugkanüle Ø 22 swg., Ø 0,7 mm	Detachable end, 22 swg. diam., 0.7 mm diam.	
<b>GF774R</b>	Saugkanüle Ø 24 swg., Ø 0,5 mm	Detachable end, 24 swg. diam., 0.5 mm diam.	



ZOELLNER

**GF770R**

Saugkanüle allein, mit Mandrin, passend zu den Saugaufsätzen GF771R und GF775R

Suction cannula only, with stylet, fitting to the detachable ends GF771R and GF775R

180 mm, 7"

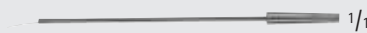

ZOELLNER

	Ø diam.	Ø diam.
<b>GF771R</b>	18 swg	1,2 mm
<b>GF772R</b>	20 swg	1,0 mm
<b>GF773R</b>	22 swg	0,7 mm
<b>GF774R</b>	24 swg	0,5 mm
<b>GF775R</b>	26 swg	0,4 mm

auswechselbare Spitzen zu GF770R und OG951R  
detachable ends, fitting to GF770R and OG951R

Bestelleinheit:

PAK = Packung à 10 Stück

Sales unit:

PAK = Package of 10 pieces



VERHOEVEN

	Ø diam.	Ø diam.
<b>GF763R</b>	16 swg	1,5 mm
<b>GF764R</b>	18 swg	1,2 mm
<b>GF765R</b>	20 swg	1,0 mm
<b>GF766R</b>	22 swg	0,7 mm
<b>GF767R</b>	24 swg	0,5 mm

Saugkanülen mit LUER-Konus

Suction cannulae with LUER cone

100 mm, 4"



HOUSE

**GF768R**

Saugadapter mit Saugunterbrecher, LUER-Konus / LUER-Bohrung

Suction adapter with finger cut-off, LUER cone, LUER hub

55 mm, 2 1/8"

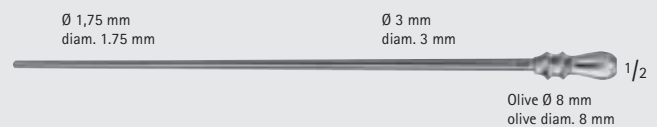

WULLSTEIN

**OF237**

Saugrohr, konisch, aus Silber, Olive mit LUER-Bohrung

Suction tube, conical, silver, olive with LUER hub

160 mm, 6 1/4"

## Sauginstrumente – Suction Instruments

Sauginstrumente

Suction Instruments

GF



WULLSTEIN

	Ø diam.
<b>OF239</b>	1,5 mm
<b>OF238</b>	2,0 mm

Saugrohr, zylindrisch, aus Silber, mit Mandrin, Olive mit LUER-Bohrung

Suction tube, cylindrical, silver, with stylet, olive with LUER hub

160 mm, 6 1/4"

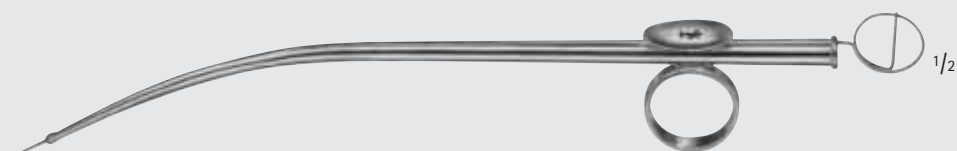

MAGILL

	Ø diam.
<b>GF906R</b>	3,0 mm
<b>GF907R</b>	3,5 mm
<b>GF908R</b>	4,0 mm

245 mm, 9 3/4"

**GF909R**

Reinigungsdraht zu MAGILL-Saugkanülen

Stilette for MAGILL suction tubes



	Ø diam.	Spitzenbreite Tip width
<b>GF919R</b>	5,0 mm	6,5 mm

Nasensaugrohr, LUER-Bohrung

Nasal suction tube, with LUER hub

180 mm, 7"

INCHES





## Sauginstrumente – Suction Instruments

Sauginstrumente  
Suction Instruments

GF

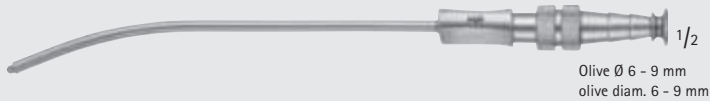

Olive  $\varnothing$  6 - 9 mm  
olive diam. 6 - 9 mm

GILLIES

$\varnothing$   
diam.

**OL187R** 3,0 mm

mit Saugunterbrecher und Mandrin  
with finger cut-off and stylet  
170 mm, 6 <sup>3</sup>/<sub>4</sub>"



ROWBOTHAM

**OM672R**

mit Mandrin  
with stylet  
295 mm, 11 <sup>3</sup>/<sub>4</sub>"

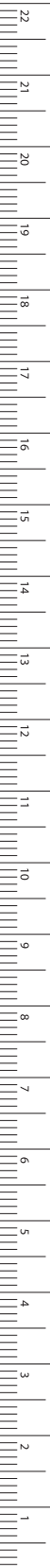

MILLIMETERS

## Sauginstrumente – Suction Instruments

Sauginstrumente

Suction Instruments

GF

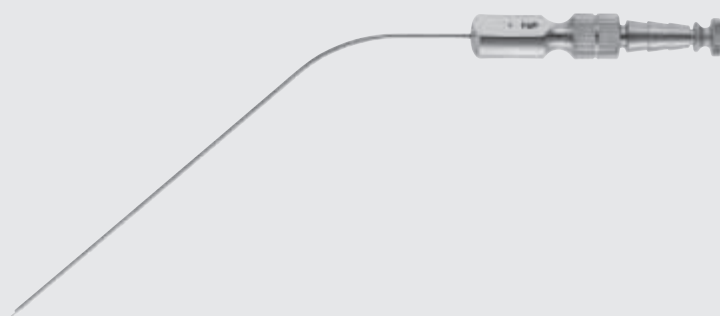

### FERGUSSON

Ø diam.	Länge Length	Länge Length	Länge Length
	130 mm	160 mm	200 mm
1,5 mm	<b>GF360R</b>	<b>GF370R</b>	<b>GF380R</b>
2,0 mm	<b>GF361R</b>	<b>GF371R</b>	<b>GF381R</b>
2,5 mm	<b>GF362R</b>	<b>GF372R</b>	<b>GF382R</b>
3,0 mm	<b>GF363R</b>	<b>GF373R</b>	<b>GF383R</b>
4,0 mm	<b>GF364R</b>	<b>GF374R</b>	<b>GF384R</b>
5,0 mm	<b>GF365R</b>	<b>GF375R</b>	<b>GF385R</b>

Ø 3,5 mm  
diam. 3.5 mm

Ø 2,0 mm  
diam. 2.0 mm

Olive  
Ø 6 - 9 mm  
olive  
diam. 6 - 9 mm

1/3

<b>OP030R</b>	500 mm	20"
<b>OP031R</b>	350 mm	14"

mit Gummispitze, mit LUER-Bohrung  
with rubber tip, with LUER hub

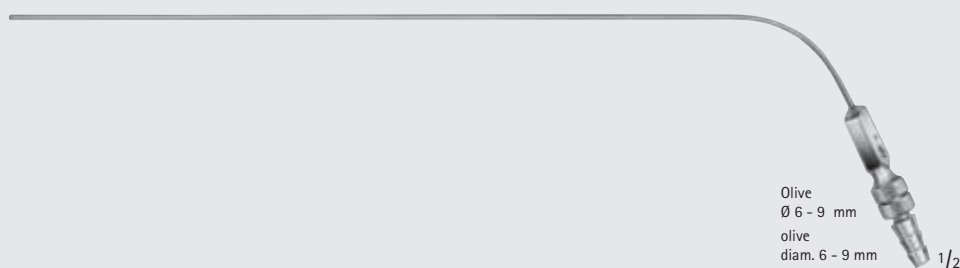

Olive  
Ø 6 - 9 mm  
olive  
diam. 6 - 9 mm

1/2

	Ø diam.
<b>OP360R</b>	2,0 mm
<b>OP361R</b>	2,5 mm
<b>OP362R</b>	3,0 mm

mit Saugunterbrecher, Griffplatte 90° zur Biegung, mit LUER-Bohrung  
with finger cut-off, thumb piece 90° to curve, with LUER hub  
250 mm, 10"

INCHES



## Sauginstrumente – Suction Instruments

### Sauginstrumente Suction Instruments

GF

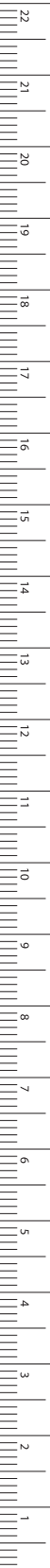

MILLIMETERS

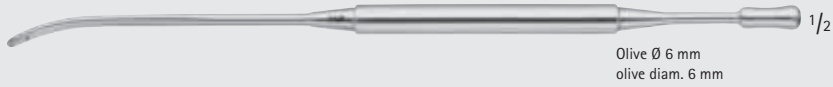

NEGUS

**OL177R**

Saugdissektor  
Suction dissector  
210 mm, 8 1/4"

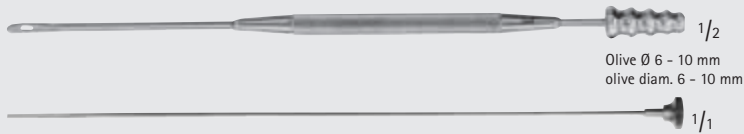

GORNEY

**OL168R**

Saugdissektor  
Suction dissector  
180 mm, 7"



breit  
wide

**OL195R** 4 mm

**OL196R** 5 mm

Saugraspatorium, scharf, bajonettförmig gebogen, mit Mandarin  
Suction raspatories, sharp, bayonet-shaped, with stylet  
200 mm, 8"



LANDOLT

breit  
wide

**GF980R** 3,2 mm

Präpariersauger für Hypophysektomie und HNO, winklige Spitze, scharf  
Dissecting suction tube for hypophysectomie and ENT, sharp angled point  
200 mm, 8"



LOPEZ-REINKE

**OM670R**

Tonsillendissektor mit Absaugvorrichtung  
Tonsil dissector with suction device  
235 mm, 9 1/4"

## Sauginstrumente – Suction Instruments

Kombinierte Saug- und Spülkanülen

Combined Suction- and Irrigation Cannulae

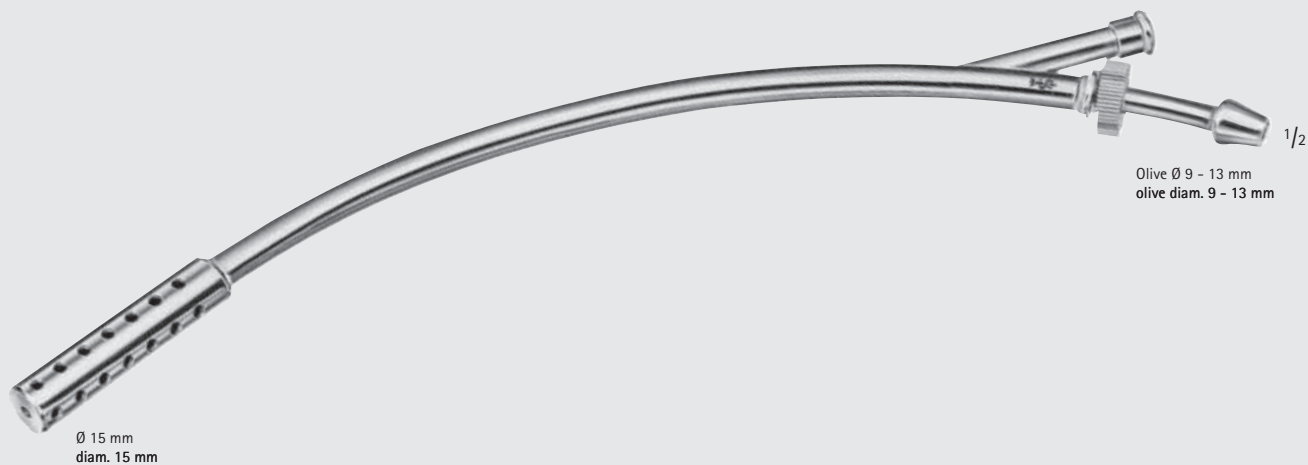

FINSTERER

**GF867C**

320 mm, 12 3/4"



YASARGIL

**GF905R**

LUER-LOCK-Konus

LUER-LOCK cone

200 mm, 8"

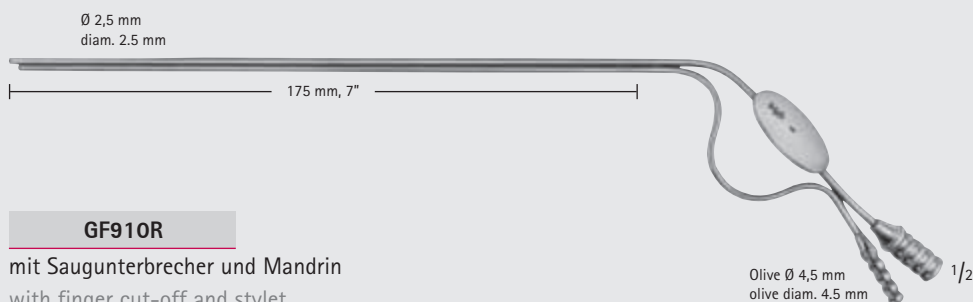

**GF910R**

mit Saugunterbrecher und Mandrin

with finger cut-off and stylet

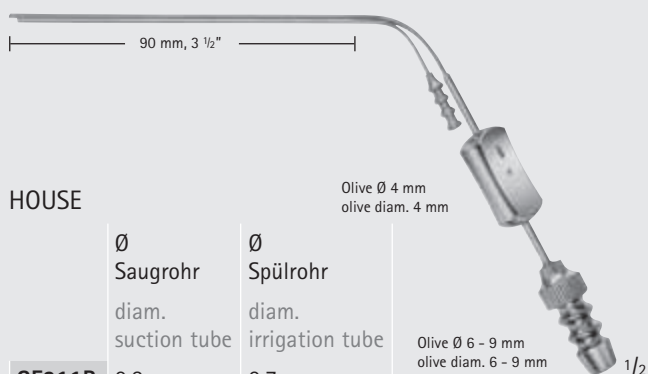

HOUSE

	Ø Saugrohr diam. suction tube	Ø Spülrohr diam. irrigation tube
<b>GF911R</b>	0,9 mm	0,7 mm
<b>GF912R</b>	1,2 mm	0,9 mm
<b>GF913R</b>	1,5 mm	1,2 mm

mit Saugunterbrecher und Mandrin, LUER-Bohrung

with finger cut-off and stylet, with LUER hub

INCHES



## Sauginstrumente – Suction Instruments

### Koagulations-Saugkanüle

### Coagulation Suction Cannula

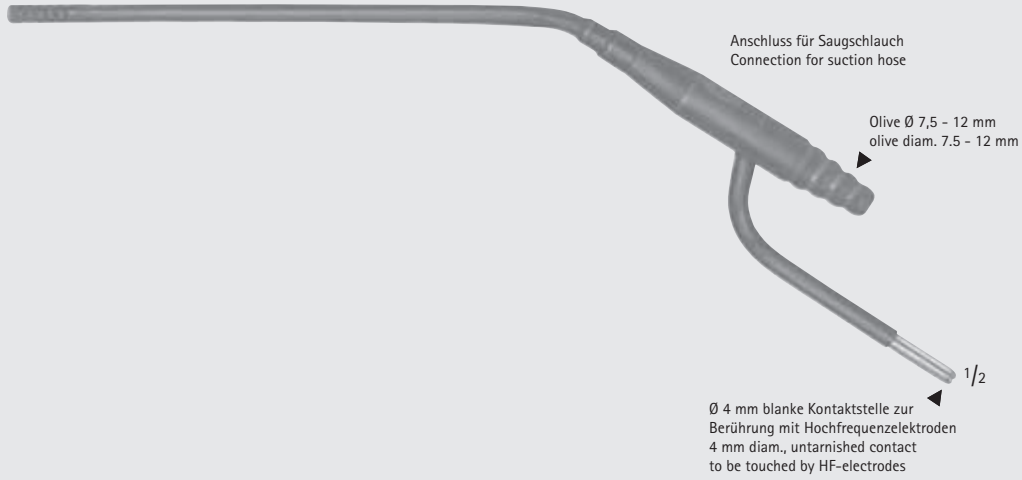

Anschluss für Saugschlauch  
Connection for suction hose

Olive Ø 7,5 - 12 mm  
olive diam. 7.5 - 12 mm

Ø 4 mm blanke Kontaktstelle zur  
Berührung mit Hochfrequenzelektroden  
4 mm diam., untarnished contact  
to be touched by HF-electrodes

LANDOLT

**GK550**

5,0 mm

mit Saugunterbrecher und Mandrin,  
sterilisierbar im Autoklav bis 143 °C (3 bar)

with finger cut-off and stylet,  
can be sterilized in an autoclave up to 143 °C (3 bar)

GF

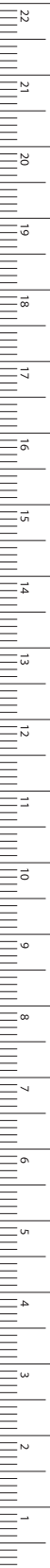

MILLIMETERS



INCHES



**JG**



**Nierenschalen, Laborschalen**  
**Kidney Trays, Bowls**

## Nierenschalen, Laborschalen – Kidney Trays, Bowls

Messbecher, Laborschalen, Nierenschalen

Medical Measures, Round Bowls, Kidney Trays

JG



**JG514R**

Medizinbecher,  
graduiert,  
0,05 Liter  
Medical measure,  
graduated,  
0.05 litre



**JG515R**

Messbecher, 0,1 Liter  
Medical measure,  
graduated, 0.1 litre



**JG516R**

Messbecher, graduiert,  
0,25 Liter  
Medical measure,  
graduated, 0.25 litre



**JG518R**

Messbecher, graduiert,  
1,0 Liter  
Medical measure,  
graduated, 1.0 litre



	Inhalt (Liter) Capacity (litre)	Abmessungen in cm (oben x unten x Höhe) Dimensions in cm (upper x lower x height)
<b>JG520R</b>	0,02	4,0 x 2,8 x 1,9
<b>JG521R</b>	0,06	6,1 x 4,2 x 3,0
<b>JG522R</b>	0,16	8,3 x 5,4 x 4,1
<b>JG523R</b>	0,4	11,1 x 7,2 x 5,6
<b>JG524R</b>	1,0	15,1 x 10,0 x 7,3
<b>JG525R</b>	2,5	21,1 x 14,5 x 9,6

Laborschalen  
Round bowls



<b>JG504R</b>	170 mm	6 3/4"
<b>JG506R</b>	250 mm	10"
<b>JG508R</b>	275 mm	10 3/4"

Nierenschalen  
Kidney trays







## Nierenschalen, Laborschalen – Kidney Trays, Bowls

Sterilisierzangen  
Sterilizing Forceps

JR



MILLIMETERS



1/3

CHEATTLE

**JG820R**

280 mm, 11"

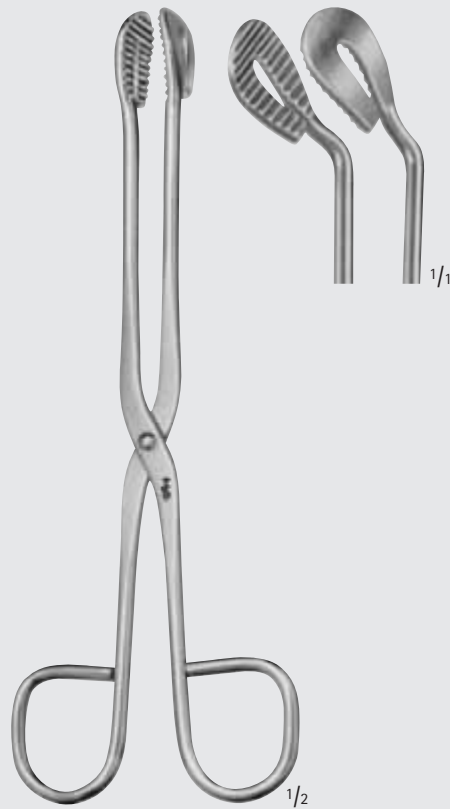

1/2

**JG822R**

210 mm, 8 1/4"



INCHES

JG



**Instrumentenpflege, Reinigungshinweise**  
Care and Maintenance of Instruments

# Instrumentenpflege, Reinigungshinweise – Care and Maintenance of Instruments

## Reinigung – Desinfektion – Sterilisation von chirurgischen Instrumenten

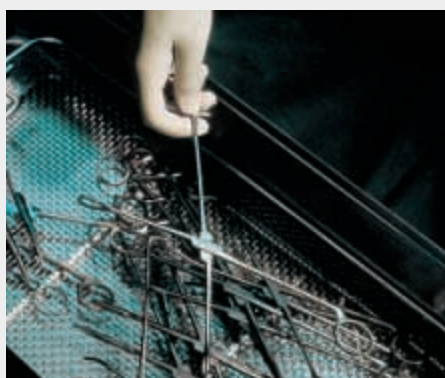

Bitte berücksichtigen Sie bei der Aufbereitung Ihrer hochwertigen Aesculap Instrumente die nachstehenden Empfehlungen.



### Behandlung fabrikneuer Instrumente

Fabrikneue Instrumente sind vor der ersten Sterilisation bzw. Nutzung zu reinigen. Schutzkappen und Schutzfolien sind vollständig zu entfernen, z.B. bei Meißeln, Raspatorien oder mikrochirurgischen Instrumenten.

### Nach jedem Gebrauch

- ⌘ Kontaminiertes Instrument schnellstmöglich aufbereiten.
- ⌘ Gelenkinstrument in einem 90°- Winkel öffnen.
- ⌘ Bei maschineller Reinigung, Instrument auf reinigungsgerechte Siebkörbe legen (Spülschatten vermeiden).
- ⌘ Zerlegbares Instrument in Einzelteile zerlegen.
- ⌘ Vorzugsweise trocken entsorgen.
- ⌘ Bei Nassentsorgung reinigungsaktive Desinfektionsmittel verwenden. Vor maschineller Reinigung und Desinfektion Instrument gründlich mit klarem, fließendem Wasser spülen.
- ⌘ Falls nötig, Ultraschallbehandlung nach den Anweisungen des Geräteherstellers durchführen:
- ⌘ als effektive mechanische Unterstützung bei manueller Reinigung,
- ⌘ zur Vorbehandlung von Instrumenten mit angetrockneten Verschmutzungen vor der maschinellen Reinigung.
- ⌘ Mikroinstrumente und Instrumente mit feinen Arbeitsenden sollten möglichst nicht im Ultraschall, sondern nur manuell oder maschinell gereinigt werden.

Bei maschineller Reinigung Mikro-Instrumente in geeigneten Lagerungshilfen lagern.

- ⌘ Manuell oder maschinell reinigen. Herstellerangaben beachten.

### Manuelle Reinigung/Desinfektion

- ⌘ Instrument in ein geeignetes reinigungsaktives Desinfektionsmittel legen, so dass alle Oberflächen, Hohlräume, Lumen und Öffnungen bedeckt sind. Anweisungen des Desinfektionsmittelherstellers beachten.
- ⌘ Nach der chemischen Desinfektion immer ausreichend und intensiv mit klarem und fließendem Wasser abspülen. Anweisungen des Desinfektionsmittelherstellers beachten.
- ⌘ Anhaftende Verschmutzungen mit einer weichen Kunststoffbürste entfernen. Keine scheuernden Reinigungsmittel oder Metallbürsten verwenden.
- ⌘ Lumen und Kanäle mit weichen Rundbürsten aus Kunststoff reinigen. Die Durchmesser von Lumen und Bürste müssen einander entsprechen.
- ⌘ Schlusspülung mit destilliertem oder vollentsalztem Wasser durchführen.
- ⌘ Instrument mit saugfähigem, weichem und fusselfreiem Tuch trocknen.
- ⌘ Lumen und Kanäle mit Druckluft trocknen.

### Maschinelle Reinigung/Desinfektion

- ⌘ Bei der Programmwahl das Material (z.B. nichtrostender Instrumentenstahl, Aluminium) des zu reinigenden Instruments berücksichtigen. Anweisungen des Geräteherstellers beachten.
- ⌘ Schlusspülung mit vollentsalztem Wasser durchführen.
- ⌘ Ausreichende Trocknungsphase einhalten.
- ⌘ Instrument sofort nach Beendigung des Programms aus der Maschine nehmen.

# Instrumentenpflege, Reinigungshinweise – Care and Maintenance of Instruments

## Reinigung – Desinfektion – Sterilisation von chirurgischen Instrumenten

### Pflege/Prüfung

- ⌘ Instrument auf Raumtemperatur abkühlen lassen.
- ⌘ Bewegliche Teile (z.B. Gelenke und Schlüsse) mit sterilisierbarem, dampfdurchlässigem Pflegeöl leicht ölen (z.B. Sterilit Ölspray JG600 oder Sterilit Instrumenten-Öl JG598).
- ⌘ Nach jeder Reinigung, Desinfektion, Instrument prüfen auf Sauberkeit, Funktion und Beschädigungen, z.B. verbogene, zerbrochene, rissige, abgenutzte und abgebrochene Teile.
- ⌘ Beschädigtes und defektes Instrument aussortieren und ersetzen.

### Packen

- ⌘ Instrument mit feinem Arbeitsende und/oder mikrochirurgisches Instrument in geeigneten Lagerungshilfen lagern.
- ⌘ Instrument mit Sperre in der ersten Raste fixieren.

### Sterilisation

- ⌘ Sterilisieren mit Dampf, dabei folgendes beachten: Die Dampfsterilisation hat nach einem validierten Dampfsterilisationsverfahren (z.B. Sterilisator gemäß EN 285/ANSI/AAMI/ISO 11134-1993, ANSI/AAMI ST46-1993 und validiert gemäß EN 554/ISO 13683) zu erfolgen. Bei einer Anwendung des fraktionierten Vakuumverfahrens ist die Sterilisation mit dem 134°C -/ 2 bar-Programm bei einer Mindesthaltezeit von 5 Minuten durchzuführen.



### Empfohlene Produkte



**STERILIT®  
JG600**

Aesculap Ölspray in Sprühdose (FCKW-frei), zur Instrumentenpflege vor der Sterilisation. Physiologisch unbedenklich nach DAB und § 31 LMBG.



**STERILIT®  
JG598**

Aesculap Instrumenten-Öl, zum Ölen der Schlüsse, Sperren usw. vor der Sterilisation. Physiologisch unbedenklich nach DAB und § 31 LMBG.

Ausführliche Informationen zur Aufbereitung individueller Aesculap Produkte finden Sie in der Datenbank "Aufbereitung/Gebrauchsanweisungen" im Internet unter:

[www.aesculap-extra.net](http://www.aesculap-extra.net)

# Instrumentenpflege, Reinigungshinweise – Care and Maintenance of Instruments

## Care and Maintenance of Surgical Instruments

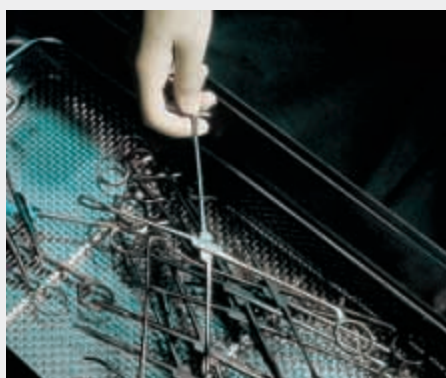

Please observe the following recommendations for the care and maintenance of your high-quality Aesculap instruments.



### Treatment of brand new Instruments

Brand new instruments must be cleaned before the first sterilization or use. Protective caps and protective films must be removed completely, for example in the case of chisels, raspatories or microsurgical instruments.

### After each use

- ✂ Clean contaminated instruments as quickly as possible.
- ✂ Open instruments with a joint to a 90°- angle.
- ✂ For machine cleaning, place instrument in a wire basket suitable for the cleaning process (make sure cleaning solution and rinse water from machine comes into contact with all surfaces of the instrument).
- ✂ Completely dismantle any dismantlable instruments.
- ✂ Preferably dry removal tray in the OR.
- ✂ For wet removal always use an active cleaning disinfectant. Rinse the instrument thoroughly with clear, flowing water before machine cleaning and disinfecting.
- ✂ If necessary, treat with an ultrasound washer. Always use according to the manufacturer's instructions:
- ✂ for effective mechanical cleaning before manual cleaning,
- ✂ for pre-treatment of instruments with dried on contaminant before machine cleaning.

- ✂ Microsurgical instruments and instruments with fine working distal ends should not be treated with ultrasound. They should be cleaned either manually or in the washing machine. In case of cleaning in a machine please use a suitable storage rack.
- ✂ If cleaning manually or in a machine: always follow manufacturer's instructions. For detergents and other cleaning solutions.

### Manual Cleaning/Disinfection

- ✂ Place instruments into a suitable disinfectant with active cleaning properties so that all surfaces, inner cavities, lumens and openings come into contact with the solution. Always follow the disinfectant manufacturer's instructions.
- ✂ After chemical disinfection, always rinse thoroughly with clear, flowing water. Always follow the instructions provided by the manufacturer of the disinfectant.
- ✂ Remove any contaminants still clinging to the instrument with a soft synthetic brush. Do not use a scouring or metal brush.
- ✂ Clean any lumens and conduits with soft, round, synthetic brushes. Please note, the lumen and the brush must have the same diameter.
- ✂ Final rinsing to be done with distilled or de-ionized water.
- ✂ Dry instrument with an absorbent, soft and lint-free cloth.
- ✂ Dry lumens and conduits with compressed air. Always use this method with caution.

### Machine Cleaning/Disinfection

- ✂ Select the program according to the material of the instrument (e.g. stainless instruments, steel, aluminium) to be cleaned. Always follow the machine manufacturer's instructions.
- ✂ Final rinsing to be done with de-ionized or demineralized water.



# Instrumentenpflege, Reinigungshinweise – Care and Maintenance of Instruments

## Care and Maintenance of Surgical Instruments

- ⌘ Leave sufficient time for drying.
- ⌘ Remove the instrument from the machine immediately after the program is finished.

### Care/Testing

- ⌘ Allow instruments to cool down to room temperature.
- ⌘ Lubricate movable parts (e.g. joints and ends) with special sterilization-capable, steam-permeable lubricant (e.g. Sterilit Oil Spray JG600 or Sterilit Instrument Oil JG598).
- ⌘ After each cleaning, disinfection process, check the instrument to make sure it is clean, that it functions properly and it has not suffered any damage, e.g. bent, broken, fractured or worn parts.
- ⌘ Remove any damaged and defective instruments and replace with functional items and send away any product which is damaged for repair.

### Storage

- ⌘ Place instruments with the fine working end and/or microsurgery instruments in a suitable storage rack. Always secure micro instruments properly.
- ⌘ Where possible sterilize instruments on the first ratchet.

### Sterilization

- ⌘ To steam sterilize, proceed as follows: Steam sterilization must be carried out according to a validated steam sterilization process (e.g. with a sterilizer meeting the specifications of EN 285/ANSI/AAMI/ISO 11134-1993, ANSI/AAMI ST46-1993 and validated according to EN 554/ISO 13683.). When using the fractional vacuum method, use the 134°C/-2 bar program for sterilization with a minimum hold time of 5 minutes.



### Recommended Products



**STERILIT®  
JG600**

Aesculap Oil Spray in aerosol can (ozone-friendly), for maintenance of instruments prior to sterilization. Physiologically inert acc. to DAB and S 31 LMBG (German Pharmacopoeia).



**STERILIT®  
JG598**

Aesculap Instrument Oil, for box locks, ratchets etc. prior to sterilization. Physiologically inert acc. to DAB and S 31 LMBG (German Pharmacopoeia).

You will find detailed information about the reprocessing of individual Aesculap products in the data base "Reprocessing/Instructions for Use" on the internet:

[www.aesculap-extra.net](http://www.aesculap-extra.net)

GR

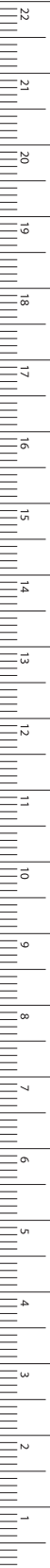

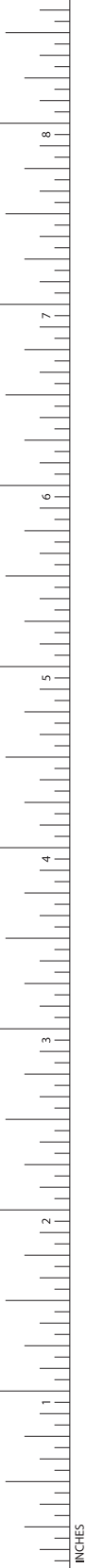

INCHES





**Alphabetischer Index**  
**Nummerischer Index**  
Alphabetical Index  
Numerical Index

# Alphabetischer Index – Alphabetical Index

## A

	Seite		Seite
<b>A</b>		<b>ALLIS-ADAIR</b> , Darm- und Gewebefasszangen	538
<b>ABBEY</b> , Schleimhaut-Resektionsnadel	515	<b>ALLIS-THOMAS</b> , Organ- und Gewebefasszangen	540
<b>ABEL</b> , Hakenzangen	677	<b>ALLISON</b> , Lungenspatel	424, 881
Abfallzangen	19	<b>ALLPORT</b> , Wundspreizer	458
Abortusküretten	713	<b>ALM</b> , Wundspreizer	457
Abortuslöffel	712	Amniotome	722
Abortuszangen	732-735	Amputationsmesser	28, 29, 917, 918
<b>ABRAHAM</b> , Tonsillennmesser	31	Amputationsretraktoren	920
<b>ADAIR</b> , Hakenzangen	674	Amputationssägen	921-923
Adapter, bipolar	522, 533	Analsonden	342, 343, 579
Saug-	1099	Analspreizer	573, 576
<b>ADLERKREUTZ</b> , Gefäß- und Tumorpinzetten	179	Anastomosenklemmen	559, 560, 843
<b>ADSON</b> , Arterienklemmen	225, 226	Anastomosenklemmen, Atraumatische-	563, 564, 566, 791-793, 799, 822, 823, 825, 828-831
Chirurgische Pinzetten	170	Rektum-	561, 562
DUROGRIP atraumatische Pinzetten	162	Anatomiescheren	68
Feine anatomische Pinzetten	151, 152	Anatomische Pinzetten	156-158
Feine chirurgische Pinzetten	168, 169	Anatomische Pinzetten, Feine-	151-155, 783
Hohlmeißelzangen	1031	<b>ANDERSON-ADSON</b> , Laminektomie-Wundspreizer	468
Laminektomie-Wundspreizer	468, 471	<b>ANGLE</b> , Drahtschneidezangen	1072
Monopolare Pinzetten	517	Anlegezangen, Bulldogklemmen	216, 786
Nadelhalter	301	Clip-	738-745
Nerv- und Gefäßhäkchen	358	Anuskope	572
Pinzetten, bajonettförmig	165	Aorta-Anastomosenklemmen, Atraumatische-	818, 819
Raspatorien	968	Aorta-Aneurysma-Klemmen, Atraumatische-	813-815
Saugkanülen	1094, 1095	Aortaklemmen, Atraumatische-	811, 816, 817, 832
Trepanationsfräser	1052	Aortenklappenhaken	884
<b>ADSON-BABY</b> , Wundspreizer	463	Aortenstanzen	852
<b>ADSON-BROWN</b> , Wundrandpinzetten	170	Appendektomieklemmen	557
<b>AESCULAP</b> , Biopsiezangen für Rektum	581	Approximatoren	211
DUROGRIP Nadelhalter	323	Approximatoren, Nerv-	212
Extensionsbügel	1061	Arterienfasszangen	196
Handbohrapparate	1054	Arterienklemmen	231-241
Korn- und Tupferzangen	10, 186	Arterienklemmen, Feine-	220-230
Plazentar- und Abortuszangen	734	Arteriotomie-Scheren	80
Tamponhalter	582	<b>ASCH</b> , Sekretlöffel	626
Waschzangen	10	Uterus-Sekretlöffel	697
<b>AESCULAP-PRATT</b> , Hakenzangen	680	<b>ASSMUS</b> , Nervstripper	1046
Organ- und Gewebefasszangen	198	ATRAUMATA, Anastomosenklemmen	791-793, 799, 808, 822, 823, 825, 828-831
Ahlen	1055, 1056	Aorta-Anastomosenklemmen	818, 819
<b>ALEXANDER</b> , Hohlmeißel	1001	Aorta-Aneurysma-Klemmen	813-815
Hohlmeißelzangen	1029	Aortaklemmen	811, 816, 817, 832
Raspatorien	974	Bronchusklemmen	812
Rippenraspatorien	863	Bulldogklemmen	218, 219, 787-790, 820, 821
<b>ALLEN</b> , Darmklemmen	547	Coarctationsklemmen	804, 826, 827
Osteophytenmeißel mit Schaber	962	Darmfasszangen	544, 545, 568
<b>ALLENBERG</b> , Durchzugsinstrumentarium für Gefäßprothesen	854	Darmklemmen	547, 548, 550, 552, 555
Gefäßklemmen	803	Druckklemmen	560, 612
Iliaca-Sperrer	475	Gallenblasenzangen	595
Wundspreizer	461	Gefäßclips	214, 215, 784, 785
<b>ALLIS</b> , Arterien- und Gewebefasszangen	196	Gefäßklemmen	794, 795, 801-803
Atraumatische Darmfasszangen	544, 568	Gewebefasszangen	544, 835-837
Atraumatische Organ- und Gewebefasszangen	836	Hämorrhoidenklemmen	584
Darm- und Gewebefasszangen	539		
Lungenfasszangen	839		



## Alphabetischer Index – Alphabetical Index

A – B

	Seite		Seite
ATRAUMATA, Hysterektomie- und Vaginalklemmen	267	<b>BABY-MOSQUITO (HARTMANN)</b> , Arterienklemmen	220
Iliaca-Klemmen	807	<b>BABY-OVERHOLT</b> , Präparier- und Ligaturklemmen	244
Kapsel-fasszangen	622	<b>BABY-ROUX</b> , Wundhaken	379
Klemmzangen	272	<b>BABY-SATINSKY</b> , Anastomosenklemmen	843
Ligaturklemmen	797, 798	<b>BABY-SENN-MILLER</b> , Wundhaken	377
Magenklemmen	557	<b>BACKHAUS</b> , Tuchklemmen	203
Mehrzweckklemmen	791-793, 809, 810, 823-825, 828, 833, 834	<b>BACKHAUS-KOCHER</b> , Tuchklemmen	203
Nierenklemmen	608, 796	<b>BAILEY</b> , Rippenkontraktoren	877
Nierenstielklemmen	612	<b>BAINBRIDGE</b> , Darmklemmen	547
Organfasszangen	191, 544, 835-837	Bajonettförmige Pinzetten	165, 166
Ovarienzangen	687	<b>BAKES</b> , Gallengangdilationsoliven	601
Pankreas-klemmen	796	<b>BALFOUR</b> , Bauchdeckenhalter	486-488
Parametriumklemmen	100, 268, 269	<b>BALFOUR-BABY</b> , Bauchdeckenhalter	485
Patent-Ductusklemmen	805, 806, 826, 827	<b>BANE-HARTMANN</b> , Hohlmeißelzangen	1028
Peripheralklemmen	805-807	<b>BARNES-NEVILLE</b> , Geburtszangen	729
Pinzetten	160, 161, 567, 782, 783	<b>BARRAQUER</b> , Lidsperrer	458
Polypenzangen	687	Mikro-Nadelhalter	283, 771
Präparierklemmen	797, 798	<b>BARRÉ</b> , Fadenhaltebügel	621
Profundaklemmen	798	Präparierklemmen	252, 619
Rektum-Anastomosenklemmen	563, 564, 566	Präparierschere	618
Ultra-Light-Pinzetten	159, 546, 781	Prostataretractor	452, 620
Vena-Cava-Klemmen	800	Urethraretractor	452, 620
Winkelklemmen	612	<b>BARRON</b> , Hämorrhoidal-Ligator	585, 586
Atriumhaken	882, 883	Saugkanülen	1097
<b>AUFRICHT</b> , Knochenraspeln	978	Skalpelli-griff	38
Aufsätze, Biopsie-	704, 705	<b>BARSKY</b> , Hauthäkchen	363
Augenpinzetten	168	<b>BARTH</b> , Scharfe Löffel	981
Augenscheren	49	Bauchdecken-haken	437-439, 443-446
<b>AUSTIN</b> , Mikro-Knüpfpinzetten	140	Bauchdeckenhalter	447, 448, 482, 483, 485-495
<b>AUVARD</b> , Scheidenspekula	656	Bauchdeckenscheren	122
		Bauchdeckenvalven	482-484
		Bauchspatel	435, 436, 450, 451
		<b>BAUMGARTNER</b> , DUROGRIP Drahtspannzangen	312, 1067
		DUROGRIP Nadelhalter	308
		Nadelhalter	299
<b>B</b>		<b>BEACHAM</b> , Amniotom	722
<b>BABCOCK</b> , Atraumatische Darmfasszangen	544	Becher, Mess-	1108
Atraumatische Organ- und Gewebefasszangen	835	<b>BECK</b> , Rongeurs	902
Atraumatische Organ-, Gewebe- und Darmfasszangen	545	Becken-zirkel	720
Lungenfasszangen	839	<b>BECKMANN-ADSON</b> , Laminektomie-Wundspreizer	470
Organ- und Gewebefasszangen	540	<b>BECKMANN-EATON</b> , Laminektomie-Wundspreizer	471
<b>BABY-ADSON</b> , Präparier- und Ligaturklemmen	245	<b>BEEBE</b> , Blech- und Drahtscheren	129
<b>BABY-ALLIS</b> , Darm- und Gewebefasszangen	538	<b>BEHRMAN</b> , Uterus-Kanülen	717
<b>BABY-COLLIN</b> , Bauchdeckenhalter	482	Beinhautmesser	29, 918
<b>BABY-CRILE (KOCHER)</b> , Arterienklemmen	222	<b>BELLUCI</b> , Saugkanülen	1098
<b>BABY-CRILE (PEAN)</b> , Arterienklemmen	222	<b>BENGOLEA</b> , Arterienklemmen	228
<b>BABY-CRILE-WOOD</b> , DUROGRIP Nadelhalter	309	<b>BENNETT</b> , Knochenheber	945
<b>BABY-KOCHER</b> , Atraumatische Darmklemmen	547	<b>BENSAUDE</b> , Anuskope	572
Darmklemmen	547	<b>BENSON</b> , Pylorus-spreizer	557
<b>BABY-METZENBAUM</b> , DUROTIP Präparierscheren	96, 102	<b>BERGER</b> , Biopsie-zangen	703
NOIR Feine Präparierscheren	105, 106	<b>BERGMANN</b> , Gipsscheren	1083
Präparierscheren	87	Hämmer	995
SuperCut Scheren	91	Skalpelle	26
<b>BABY-MIKULICZ</b> , Peritoneumklemmen	257	Wund- und Trachealhäkchen	364
<b>BABY-MIXTER</b> , Präparier- und Ligaturklemmen	244		

A-Z

# Alphabetischer Index – Alphabetical Index

## B

	Seite		Seite
<b>BERKELEY-BONNEY</b> , Hysterektomieklemmen	266	Bohrfutter, Hand-	1064
<b>BERNHARD</b> , Hakenzangen	674	Bolzenschneider	1078
Tuchklemmen	203	<b>BONNER MODELL</b> , Mikro-Knüpfpinzetten	139
<b>BERRY</b> , DUROGRIP Drahtspannzangen	312, 1068	<b>BONNEY</b> , Anatomische Pinzetten	158
Beschneidungsklemmen	631	Chirurgische Pinzetten	177
<b>BETHUNE</b> , Rippenscheren	857	Polypen- und Ovarienzangen	688
<b>BEYER</b> , Hohlmeißelzangen	1029, 1032	<b>BOROWSKI</b> , Aortenklappenhaken	884
Biegeinstrumente	1059	<b>BORST</b> , Fixierklemmen	842
Biegezangen für Kirschnerdrähte	1071	<b>BOSE</b> , Wund- und Trachealhäkchen	364
<b>BIEMER</b> , Anlegepinzetten für Gefäßclips	210, 211	Wundspreizer	456
Gefäßclips	210	Bougies, Harnröhren-	629, 630
Mikro-Approximatoren	211	<b>BOWMAN</b> , Sonden	347
Mikro-Venenscheren	51	<b>BOYS-ALLIS</b> , Arterien- und Gewebefasszangen	196
Nerv-Approximator	212	Darm- und Gewebefasszangen	538
<b>BIEMER-MÜLLER</b> , Approximatoren	211	<b>BOZEMANN</b> , Scheidenspekula	658
<b>BIER</b> , Amputationssägen	922	Tamponzangen	672, 673
Biopsie-Instrumente für Knochen	1057	Uterusscheren	119
Biopsieaufsätze	704, 705	<b>BOZEMANN-DOUGLAS</b> , Tamponzangen	673
Biopsieküretten, Endometrium-	698	<b>BRAITHWAITE</b> , Handdermatom	35
Biopsiezangen	699-704, 706	<b>BRAND</b> , Sehnenführungszangen	195
Biopsiezangen für Rektum	580-582	<b>BRAUN</b> , Hakenzangen	675, 678
Biopsiezangen, Aufsätze	581, 704, 705	Organ- und Gewebefasszangen	197
Bipolare Anschlusskabel	532, 533	Scheidenspekula	648
Bipolare Klemmen	531	Uterus-Depressor	671
Bipolare Koagulationspinzetten	523-527	<b>BRAUN-STADLER</b> , Dammscheren	124, 724
Bipolare Pinzetten	528, 529, 620	Sternumscheren	856
Bipolare Präparierscheren	530	<b>BREISKY</b> , Scheidenspekula	653
<b>BIRCHER</b> , Meniskus- und Knorpelzangen	1043	<b>BRIDGE</b> , Arterienklemmen	230
<b>BIRCHER-GANSKE</b> , Meniskus- und Knorpelzangen	1043	<b>BRISTOW</b> , Knochenheber	933
<b>BIRKETT</b> , Arterienklemmen	228	<b>BRODIE</b> , Analsonden	579
<b>BISHOP-HARMON</b> , Chirurgische Pinzetten	168	Hohlsonden	342
<b>BLAKE</b> , Embolusfasszangen	846	<b>BROM</b> , Nerv- und Gefäßhäkchen	357
Gallensteinzangen	603	Bronchusklemmen	845
Uterusküretten	711	Bronchusklemmen, Atraumatische-	812
Blasenhalsspreizer	622	<b>BROPHY</b> , Chirurgische Pinzetten	173
Blasenspatel	496, 617	Feine anatomische Pinzetten	155
Blasensprenger	722	<b>BROWN</b> , Chirurgische Pinzetten	170
Blasenswundspreizer	496, 617	<b>BRÜNINGS</b> , Verlängerungsrohre	705
Blechscheren	129, 1072, 1073	Zungenspatel	4
Blechscheren, DUROTIP	1072	<b>BRUNNER</b> , Führungs-Hohlsonden	336
Bleihand	1049	Rektum-Anastomoseklemmen	561
<b>BLOUNT</b> , Wund- und Meniskushaken	400, 1045	Rippenscheren	858
<b>BLUMENTHAL</b> , Hohlmeißelzangen	1028	Unterbindungsnadeln	336, 1056
Blutschöpfer	453	Wundhaken	418, 419
Blutsperr	916	<b>BRUNS</b> , Gipsscheren	135, 138, 1084
<b>BÖHLER</b> , Extensionsbügel	1062	Scharfe Löffel	984, 987
Hohlmeißelzangen	1032	<b>BRYANT</b> , Tupferzangen	184
Knochensplitterzangen	1040	<b>BUCHWALD</b> , Zungenspatel	4
Bohrapparate, Hand-	1052, 1053	<b>BUCK</b> , Watteträger	349
Bohrdrähte	1058, 1059	<b>BUCK-GRAMCKO</b> , Knochenheber	932
Bohrer, Knochen-	1055	<b>BÜCHS</b> , Raspatorien	972
Spiral-	1054	Wundhaken	407
Trepanations-	1052, 1053	Bügel, Extensions-	1060-1062
		Fadenhalte-	621



# Alphabetischer Index – Alphabetical Index

B – C

A-Z

	Seite		Seite
Bulldogklemmen	216, 217, 786, 787	Chirurgische Nadeln	276-278
Bulldogklemmen, Atraumatische-	218, 219, 788-790, 820, 821	Chirurgische Pinzetten	170, 173-179
Bulldogscheren	76	Chirurgische Pinzetten, Feine-	168, 169, 171, 172
Bumerang Nadelhalter	326, 623	Chirurgische Scheren	71-75, 82, 122
<b>BUMM</b> , Plazentar- und Abortusküretten	713	Chirurgische Scheren, DUROTIP	93, 101
Uterusküretten	710	Cholezystektomieklappen	592
<b>BUNNEL</b> , Sehnendurchziehsonden	1048	<b>CITELLI</b> , Stanzen	892
Sehnenstripper	1047	<b>CITELLI-BEYER</b> Stanzen	892
<b>BUNNELL</b> , Handbohrapparat	1054	<b>CLAR</b> , Stirnlampen	3
<b>BUNT</b> , Sterilisierklammern	207	<b>CLAUS VAN EICKEN</b> , Unterbindungsnadeln	333
<b>BURKE</b> , Parametriumklappen	271, 692, 693	Clipanlegepinzetten	210, 211
<b>BUSHE</b> , Scharfe Löffel	986	Clipanlegezangen	738-745
		Clips, Atraumatische Gefäß-	214, 215, 784, 785
		Gefäß-	210, 213
		Titanligatur-	738, 740, 742, 744
<b>C</b>		<b>CLOWARD</b> , Wirbelkörperspreizer	481
<b>CAIRNS</b> , Arterienklappen	223	<b>CLOWARD MODIF.</b> , Wirbelsäulen-Wundspreizer	480
Durahäkchen	360	Coarctationsklappen, Atraumatische-	804, 826, 827
Knochendeckelelevatorien	930	<b>COBB</b> , Raspatorien	974
<b>CAIRNS-DOTT</b> , Feine anatomische Pinzetten	154	<b>COBBETT</b> , Handdermatom	35
<b>CANNY-RYALL</b> , Wundhaken	386	Colectomie-Klappen	554
CARBOTRAC Wundhaken	412	<b>COLLER</b> , Arterienklappen	224
Carotis Shunt Klappen	842	<b>COLLEY</b> , Atraumatische Patent-Ductusklappen	827
<b>CARREL</b> , Arterienklappen	220	<b>COLLIN</b> , Arterienklappen	241
<b>CASPAR</b> , Fadengabel	339	Atraumatische Darmfasszangen	544
Küretten	988, 989	Atraumatische Organ- und Gewebefasszangen	191, 837
Nerv- und Gefäßhäkchen	359	Bauchdeckenhalter	482
Raspatorien	969	Darmfasszangen	541
Rongeuere	904-906, 910	Klammerentfernungsangen	352
Scharfe Löffel	988	Korn- und Tupferzangen	189
Skalpellgriff	44	Nabelschnurklappen	724
Stößel	997	Nierenfasszangen	613
Wirbelsäulen-Wundspreizer	478, 479	Organ- und Gewebefasszangen	192
Wundhaken	408	Scheidenspekula	636
<b>CASTANEDA</b> , Atraumatische Anastomosen- und Mehrzweckklappen	791	Tupfer- und Schwammzangen	192
<b>CASTROVIEJO</b> , Augenscheren	49	Uterusfasszangen	688, 689
Chirurgische Pinzetten	168	Uterusküretten	711
DUROGRIP Nadelhalter	286, 287, 773, 774	Wundhaken	380
Mikro-Federscheren	48	Zungenzange	16
Mikro-Nadelhalter	282, 770	<b>COLLIN-HARTMANN</b> Wundhaken	378
<b>CATLIN</b> , Amputationsmesser	28, 917	<b>COLLIN-POZZI</b> , Hakenzangen	675
<b>CAWTHORNE</b> , Watteträger	347	<b>CONE</b> , Hemilaminektomiespreizer	469
Cerclagedraht	1065	<b>CONVERSE</b> , DUROGRIP Nadelhalter	307
<b>CHADWICK</b> , Feine Scheren	67	Nadelhalter	299
Zahnfleissscheren	67	Nasenflügelretractor	363
<b>CHAMPIONNIÈRE</b> , Knochenbohrer	1055	Wundhäkchen	363
<b>CHANDLER</b> , Elevatorien	930	<b>COOLEY</b> , Anastomosen- und Mehrzweckklappen	828
<b>CHAPUT</b> , Arterienfasszangen	196	Atraumatische Anastomosen- und Mehrzweckklappen	792, 793, 825
Darm- und Gewebefasszangen	538	Atraumatische Anastomosenklappen	822, 829, 831
<b>CHARNLEY</b> , Chirurgische Pinzetten	178	Atraumatische Aortaklemme	832
<b>CHARRIÈRE</b> , Amputationssägen	921, 922	Atraumatische Bulldogklappen	820, 821
<b>CHEATTLE</b> , Sterilisierzangen	1109	Atraumatische Coarctationsklappen	826, 827
<b>CHERON</b> , Korn- und Tupferzangen	189	Atraumatische Mehrzweckklappen	823, 824, 833

# Alphabetischer Index – Alphabetical Index

C – D

A-Z

	Seite		Seite
<b>COOLEY</b> , Atraumatische Patent-Ductusklemmen	826	<b>D</b>	
Atraumatische Pinzetten	161, 783	Dammscheren	124, 724
Atriumhaken	882	<b>DANDY</b> , Arterienklemmen	221
Feine anatomische Pinzetten	155, 783	Darm-Zwillingsklemmen	556
Gefäßscheren	114	Darmfasspinzetten	543
Sternumsperrer	873	Darmfasszangen	538, 539, 541, 542
<b>COOLEY MODIF. STRUCK</b> , Atriumhaken	883	Darmfasszangen, Atraumatische-	544, 545, 568
<b>COOLEY-BECK</b> , Atraumatische Anastomosenklemmen	822	Darmklemmen	547-551, 553-555
<b>COOPER</b> , Chirurgische Scheren	73	Darmklemmen, Atraumatische-	547, 548, 550, 552, 555
Unterbindungsnadeln	334	Darmnadeln	278
<b>CORYLLOS</b> , Wundhaken	425	Darmpinzetten	180, 543
<b>COTTLE</b> , Bulldog-Scheren	76	Darmquetschklemmen	558
Fischschwanzosteotom	1001	Darmscheren	125, 127, 567
Fixierpinzetten	165	Darmspatel	435, 436, 450, 451
Hämmer	992	<b>DARTIGUES</b> , Nierenfasszangen	613
Hauthäkchen	361	Uterusfasszangen	689
Nasenflügelretractor	373	<b>DAUBENSPECK</b> , Scharfe Löffel	985
Osteotome	1001	<b>DAVIDSON</b> , Scapula Haken	426, 880
Raspatorien	965, 969	<b>DAVIS</b> , Gefäßspatel	850
Wund- und Venenhaken	373	<b>DE BAKEY</b> , Arteriotomiescheren	80
<b>COTTLE-KNAPP</b> , Präparierscheren	77	Atraumatische Anastomosen- und Mehrzweckklemmen	792
<b>COTTLE-MASING</b> , Präparierscheren	77	Atraumatische Aorta-Aneurysma-Klemmen	813-815
<b>CRAFOORD</b> , Arterienklemmen	229	Atraumatische Aortaklemmen	817
<b>CRAFOORD MODIF.</b> , Arterienklemmen	230	Atraumatische Bulldogklemmen	218, 219, 788-790
Gefäßklemmen	844	Atraumatische Coarctationsklemmen	804
<b>CRAFOORD-SELLORS</b> , Gefäßklemmen	844	Atraumatische Gefäßklemmen für Tangential-Verschluss	801
<b>CRILE</b> , Arterienklemmen	222, 224	Atraumatische Iliaca-Klemmen	807
Nadelhalter	305	Atraumatische Mehrzweckklemmen	809, 810
Nerv- und Gefäßhäkchen	357	Atraumatische Patent-Ductusklemmen	805
Wundhaken	379	Atraumatische Peripheralklemmen	805-807
<b>CRILE-MURRAY</b> , Nadelhalter	300	Atraumatische Pinzetten	160, 161, 546, 567, 782, 783
<b>CRILE-WOOD</b> , DUROGRIP Nadelhalter	309	Atraumatische Präparier- und Ligaturklemmen	798
Nadelhalter	300	DUROGRIP Nadelhalter	313, 314, 776, 777
<b>CUSCO</b> , Scheidenspekula	637, 638	DUROTIP Gallengangscheren	597
<b>CUSHING</b> , Chirurgische Pinzetten	173	DUROTIP Gefäßscheren	100
DUROGRIP Pinzetten	164	Femur-Wundspreizer	473
Feine anatomische Pinzetten	155	Gefäßdilatoren	847
Fräser	1052	Gefäßscheren	110
Nerv- und Gefäßhäkchen	357, 359	Offset-Schere	111
Rongeurs	902, 903, 906	Präparierschere	80
Wund- und Venenhaken	375, 376	Rippensperrer	870, 871
<b>CUSHING-KOCHER</b> , Wund- und Venenhaken	374	Saugkanülen	885, 1094
Cystikusklemmen	591, 593	<b>DE BAKEY (LAMBERT MODIF.)</b> , Atraumatische	819
<b>CZERNY</b> , Gallensteinzangen	604	Aorta-Anastomosenklemmen	
Hakenzangen	679	<b>DE BAKEY (MORRIS MODIF.)</b> , Atraumatische	811
Mastdarm-Rektum-Spekula	570	Aortaklemmen	
Organ- und Gewebefasszangen	197	Atraumatische Rektum-Anastomoseklemmen	563
Wundhaken	384	<b>DE BAKEY (SEMB MODIF.)</b> , Atraumatische Aorta-	813
		Aneurysma-Klemmen	
		<b>DE BAKEY-BAINBRIDGE</b> , Atraumatische Gefäßklemmen	794
		<b>DE BAKEY-BECK</b> , Atraumatische Vena-Cava-Klemmen	800
		<b>DE BAKEY-HARKEN</b> , Atraumatische Vena-Cava-Klemmen	800
		<b>DE BAKEY-HESS</b> , Bulldogklemmen	217, 787



# Alphabetischer Index – Alphabetical Index

D

A-Z

	Seite		Seite
<b>DE BAKEY-MC QUIGG-MIXTER</b> , Atraumatische Präparier- und Ligaturklemmen	797	Dissektoren, Saug- Tonsillensaug-	1103 1103
<b>DE BAKEY-MIXTER</b> , Atraumatische Präparier- und Ligaturklemmen	797	Distraktor	1014
<b>DE BAKEY-PEAN</b> , Atraumatische Gefäßklemmen	795	<b>DITTEL</b> , Gallengangdilatoren Metallbougie-Öffner	600 629
<b>DE BAKEY-RUMEL</b> , Atraumatische Präparier- und Ligaturklemmen	797	<b>DIXON-LOVELACE</b> , Arterienklemmen	225
<b>DE BAKEY-SATINSKY</b> , Atraumatische Gefäßklemmen für Tangential-Verschluss	802	<b>DOCKHORN</b> , Wundhaken	408
<b>DE LEE</b> , Beckenzirkel	720	Doppelknopfsonden	346
<b>DE MARTEL</b> , Umführungsinstrumente	925	Dosen, Nadel-	279
<b>DE MARTEL-WOLFSON</b> , Anastomosenklemmen Schließzangen	559 559	<b>DOYEN</b> , Atraumatische Darmklemmen	548, 550
<b>DEAVER</b> , Chirurgische Scheren	75	Bauchdeckenhaken	446
Wundhaken	429-434	Darmklemmen	548-550
<b>DEMEL</b> , Drahtspannzangen	1065	Gallenblasenzangen	596
Drahtumführungsnadeln	1066	Hohlsonden	342
<b>DENIS-BROWNE</b> , Bauchdeckenhalter	490	Myomheber	690
Darmpinzetten	180, 543	Nadelhalter	299
Depressor, Uterus-	671	Polypen- und Ovarienzangen	687
<b>DERF, DUROGRIP</b> Nadelhalter	307	Raspatorien	976
Nadelhalter	299	Rippenraspatorien	861
Dermatome	35	Scheidenspekula	650, 651, 654
<b>DERRA</b> , Atraumatische Anastomosen- und Mehrzweckklemmen	793	Wundhaken	444
<b>DERRA-COOLEY</b> , Atraumatische Anastomosenklemmen	823	<b>DOYEN-CHILD</b> , Bauchdeckenhalter	447
<b>DESCHAMPS</b> , Unterbindungsnadeln	329-333	Drähte, Bohr-	1058, 1059
<b>DESJARDINS</b> , Gallengangsonden	599	Draht, Cerclage-	1065
Gallenkanal- und Cystusklemmen	591	Drahtbiegezangen	1069, 1071, 1073
Gallensteinlöffel	602	Drahtbürstchen	523
Gallensteinzangen	605	Drahtfazzzangen	1070, 1071
Präparier- und Ligaturklemmen	256	Drahtfazzzangen, DUROGRIP	1067
<b>DESMARRES</b> , Wund- und Venenhaken	373	Drahtsägen	924
<b>DIADUST</b> , Mikro-Nadelhalter	289, 291, 293, 295, 296, 759, 761, 763, 765-767, 769	Drahtscheren	129, 1072, 1073
Mikro-Pinzetten	145, 147, 149, 150, 753, 755, 757, 769	Drahtscheren, DUROTIP	100, 1072
Nadelhalter	297, 298, 767	Drahtschlingenelektroden	511, 512
<b>DICK</b> , Atraumatische Anastomosenklemmen	808	Drahtschneidezangen	1068, 1072-1078
Atraumatische Druckklemmen	560	Drahtspannzangen	1065
Atraumatische Klemmzangen	272	Drahtspannzangen, DUROGRIP	312, 1067, 1068
<b>DIEFFENBACH</b> , Bulldogklemmen	216, 786	Drahtumführungsnadeln	1066
<b>DIETRICH</b> , Atraumatische Aortaklemmen	816	Druckklemmen	584, 612
Bulldogklemmen	787	Druckklemmen, Atraumatische-	612
Gefäßscheren	110	Ductusklemmen, Atraumatische-	805, 806, 826, 827
<b>DIETRICH-HEGEMANN</b> , Gefäßscheren	110	<b>DUNHILL</b> , Arterienklemmen	222, 227
Dilatoren, Gallengang-	600, 601	<b>DUPLAY</b> , Hakenzangen	677
Gefäß-	847, 848	Korn- und Tupferzangen	185
Nabelschnur-	724	Durahäkchen	360-363
Tracheal-	474	Durascheren	112
Uterus-	662-666	Durchzugsinstrumente für Gefäßprothesen	853, 854
<b>DINGMANN</b> , Knochenhalte zangen	1017	<b>DURHAM</b> , Wundhaken	405
<b>DINGMANN MODIF.</b> , Knochenhalte zangen	1017	DUROGRIP, Drahtfazzzangen	1067
Dissektoren	849, 850, 928, 929	Drahtspannzangen	312, 1067, 1068
Dissektoren, Phlebo-	889	Knochenraspeln	979
		Nadelhalter	286, 287, 307-310, 312-321, 324, 568, 773-779
		Nadelhalter mit Schere	311
		Nahtpinzetten	163, 178
		Pinzetten	162-164, 543

# Alphabetischer Index – Alphabetical Index

D – F

A – Z

	Seite		Seite
<b>DURROTIP</b> , Draht- und Blechscheren	100, 1072	<b>F</b>	
Gallengangsscheren	597	Fadengabel	339
Ligaturscheren	104	Fadenhaltebügel	621
Scheren	92–100, 103	Fadenhaltezangen	326, 622
Scheren mit Wellenschliff	101–104	Fadenklemmen	213
Uterusscheren	103	Fadenmesser	43
<b>DUVAL</b> , Darmfasszangen	542	Fadenpinzetten	158
Darmpinzetten	180, 543	Fadenscheren, DURROTIP	92, 101
Lungenfasszangen	839	Mikro-	60, 768
<b>DUVAL-COLLIN</b> , Darmfasszangen	541	<b>FARABEUF</b> , Knochenhaltezangen	1019
		Raspatorien	971
		Wundhaken	379
		<b>FARABEUF-COLLIN</b> , Raspatorien	971
<b>E</b>		<b>FARABEUF-LAMBOTTE</b> , Knochenhaltezangen	1019
<b>EAST GRINSTEAD (WARD)</b> , Flachmeißel	1002	<b>FARRELL</b> , Watteträger	348, 350
Osteotome	1002	Fasszangen, Arterien-	196
<b>EASTMAN</b> , Flachmeißel	1002	Atraumatische Darm-	544, 568
<b>ECHLIN</b> , Hohlmeißelzangen	1033	Atraumatische Gewebe-	544, 545, 835–837
<b>ECKHOFF</b> , Zeichenfeder	25	Atraumatische Kapsel-	622
Einmal-Elektrodenhandgriffe	508	Atraumatische Organ-	191, 544, 545, 835–837
Einmalskalpelle	22–24	Darm-	538, 539, 541, 542
Elektrische Haarschneidemaschinen	9	Draht-	1070, 1071
Elektroden, Drahtschlingen-	511, 512	Draht-, DUROGRIP	1067
Kugel-	510, 511, 513	Embolus-	846
Lanzetten-	509	Gewebe-	193, 196–199, 538–540, 543
Messer-	509, 511	Hämorrhoiden-	585
Nadel-	509–513	Ligamentum-flavum-	913
Platten-	510	Lungen-	838, 839
Schlingen-	509, 513	Nieren-	613
Elektrodenhandgriffe	506–508, 513	Organ-	193, 197–199, 540, 543
Elektrodenhandgriffe, Einmal-	508	Rippen-	859
Elevatorien	930, 931, 963	Sehnen-	194
Elevatorien, Knochendeckel-	930	Tumor-	909
Embolusfasszangen	846	Uterus-	688, 689
<b>EMMET</b> , Fistelhaken	372	Vorhaut-	625
Korn- und Tupferzangen	189	<b>FAURE</b> , Biopsiezangen	700
Endarterektomiestripper	851	Peritoneumklemmen	260
Endometrium-Biopsieküretten	698	<b>FAVOLORO</b> , Gefäßscheren	111
Endospekula für Harnröhre und Cervix	667	<b>FEILCHENFELD</b> , Splitterpinzetten	181
<b>ENGEL</b> , Gipssägen	1082	Feilen, Knochen-	978–980
<b>ENGL. MODELL</b> , Tuckklemmen	201	Nagel-	13
Entfernungshaken, I.U.D.	697	Feine anatomische Pinzetten	153, 783
Enukleationsscheren	77	Feine Präparierscheren	62, 63, 76, 78, 80, 81
<b>EPPENDORF</b> , Biopsiezangen	703	Feine Präparierscheren, NOIR-	105
Ersatzklingen	9	Feine Scheren	12, 61, 63–70
<b>ESMARCH</b> , Gipsmesser	1082	Feine Scheren, DURROTIP	92
Gipscheren	135, 138, 1083	Femur-Wundspreizer	473
Staubbinde	916	<b>FERGUSSON</b> , Druckklemmen	584
Explorationshäkchen	359	Knochenhaltezangen	1018
Extensionsbügel	1060–1062	Saugkanülen	1095, 1096, 1102
Extraktionszangen für Bohrdrähte	1070, 1071	<b>FERGUSSON-ACKLAND</b> , Mundsperrer	14
Extraktoren, Phleb-	889	<b>FERRIS-SMITH</b> , DUROGRIP Pinzetten	163
		<b>FICKLING</b> , Arterienklemmen	237
		Finger-Goniometer	8





# Alphabetischer Index – Alphabetical Index

F - G

A-Z

	Seite		Seite
Fingerringsägen	1079	Gallenblasenzangen, Atraumatische-	595
<b>FINOCHIETTO, DUROGRIP</b> Nadelhalter	318	Gallengang-Klemmzangen	590
Präparier- und Ligaturklemmen	251, 840	Gallengangdilatoren	600, 601
Rippensperrer	866-868	Gallengangscheren	596, 597
Thoraxsperrer	864, 865	Gallengangscheren, DUROTIP	597
<b>FINOCHIETTO-BURFORD</b> Rippensperrer	869	Gallengangsonden	598, 599
<b>FINSEN</b> , Wundspreizer	456	Gallenkanal-Klemmzangen	590-593
<b>FINSEN MODIF.</b> , Wundspreizer	456	Gallensteinlöffel	602
<b>FINSTERER</b> Saug- und Spülkanülen	886, 1104	Gallensteinzangen	603-605
<b>FISCH</b> , Dura- und Hauthäkchen	363	<b>GARRETT</b> , Gefäßdilatoren	848
Fischschwanzosteotom	1001	Geburtslöffel	730
Fistelhaken	372	Geburtszangen	726-729
Fistelmesser	30	Gefäß-Spülkanülen	846
Fistelsonden	343, 579	Gefäßclips	210, 213
Fixierklemmen	842	Gefäßclips, Atraumatische-	214, 215, 784, 785
Fixierpinzetten	165	Gefäßdilatoren	847, 848
Flachmeißel	998-1003, 1006, 1007, 1010	Gefäßhäkchen	356-359
Flachzangen	1069, 1070	Gefäßklemmen	844
<b>FÖRSTER-BALLENGER</b> Gallenblasenzangen	594	Gefäßklemmen, Atraumatische-	794, 795, 801-803
Tupfer- und Schwammzangen	190	Gefäßprothesen-Durchziehungen	854
<b>FOMON</b> , Knochenfeilen	979	Gefäßscheren	63, 78, 108-115, 751
Knochenraspeln	979	Gefäßscheren, DUROTIP	100
Nasenflügelretractor	370	Gefäßspatel	849, 850
Nasenflügelscheren	77	<b>GELPI</b> , Hautspreizer	473
<b>FORMBY</b> , Saugkanülen	1097	Vulva-Spreizer	473, 659
<b>FOWLER</b> , Tonsillennmesser	31	<b>GEMINI</b> , Präparier- und Ligaturklemmen	248
Fräser, Trepanations-	1052, 1053	<b>GERALD</b> , Feine anatomische Pinzetten	154
<b>FRASER-KELLY (CRILE)</b> , Arterienklemmen	226	Feine chirurgische Pinzetten	172
<b>FRAZIER</b> , Hauthäkchen	360	Mikro-Pinzetten	149, 757
Saugkanülen	1096	Gestationskalkulator	720
<b>FREER</b> , Dissektoren	849	Gewebe-Auffangsieb	714, 1090
Flachmeißel	998	Gewebefasspinzetten	179, 180, 543
Hauthäkchen	361	Gewebefasszangen	190, 192, 193, 196-199, 538-540, 543
Hohlmeißel	998	Gewebefasszangen, Atraumatische-	544, 835-837
Raspatorien	963-965	Gewebekralle	363
<b>FREER-YASARGIL</b> , Raspatorien	965	<b>GIERTZ-STILLE</b> , Rippenscheren	858
Fremdkörperzangen	200, 626, 672	<b>GIGLI</b> , Drahtsägen	924
<b>FRIEDMAN</b> , Hohlmeißelzangen	1026	<b>GILLIES</b> , DUROGRIP Nadelhalter mit Schere	311
<b>FRITSCH</b> , Bauchdeckenhaken	445	Feine anatomische Pinzetten	154
<b>FRYKHOLM</b> , Hohlmeißelzangen	1033	Feine chirurgische Pinzetten	172
<b>FUCHSIG</b> , Arterienklemmen	225	Hauthäkchen	362
Führungs-Hohlsonden	336-338	Monopolare Pinzetten	517
Führungsnadeln	353	Nadelhalter mit Schere	304
		Osteotome	999
		Saugkanülen	1101
<b>G</b>		Gipsabreißzangen	1087
<b>GABRIEL</b> , Hämorrhoidal-Kanülen	587	Gipsmesser	1082
Hämorrhoidal-Spritze	587	Gipssägen	1082
Rektum-Spekula	573	Gipsscheren	134, 135, 1083-1086
<b>GALABINS</b> , Uterussonden	670	Gipsspreizer	1087
<b>GALLAHER</b> , Knochenfeilen	978	<b>GLASSER</b> , DIADUST Mikro-Nadelhalter	296, 766
Gallenblasenscheren	596	Glocken, Saug-	725
Gallenblasenzangen	594-596	<b>GLOVER</b> , Atraumatische Anastomosenklemmen	799

# Alphabetischer Index – Alphabetical Index

G - H

A - Z

	Seite		Seite
<b>GLOVER</b> , Atraumatische Bulldogklemmen	218, 219, 788, 789	Hämorrhoidal-Ligatoren	585, 586
<b>GLUCK</b> , Rippenscheren	857	Hämorrhoidal-Spritze	587
<b>GOELET</b> , Wundhaken	386	Hämorrhoidenklemmen	583
<b>GOLDMAN-FOX</b> , Zahnfleissschere	92	Hämorrhoidenklemmen, Atraumatische-	584
<b>GOLIGHER</b> , Bauchdeckenhalter	488	<b>HAIGHT</b> , Rippensperrerr	867
Goniometer Finger-	8	<b>HAJEK</b> , Hämmer	993
<b>GORNEY</b> , Präparierscheren	81	Spülkanülen	598
Saugdissektoren	1103	Wundhaken	385
SuperCut Scheren	90	<b>HAJEK-KOFLER</b> Stanzen	893, 894
<b>GOSLEE</b> , Drahtbiegezangen	1069	<b>HAKANSSON</b> , Hohlmeißelzangen	1028
<b>GOSSET</b> , Bauchdeckenhalter	485	Haken, Aortenklappen-	884
<b>GOULIAN</b> , Handdermatom	34	Atrium-	882, 883
<b>GOURDET</b> , Uteruslöffel	707	I.U.D.-Entfernungs-	697
<b>GRAEFE</b> , Chirurgische Pinzetten	170	Meniskus-	1045
Haut- und Wundhäkchen	360	Scapula-	880
Nerv- und Gefäßhäkchen	356	Hakenzangen	674-684
Präparierscheren	76	<b>HALLE</b> , Dissektoren	849
<b>GRAVE</b> , Scheidenspekula	640	Elevatorien	963
<b>GRAY</b> , Cholezystektomieklemmen	592	Scharfe Löffel	985
Präparier- und Ligaturklemmen	256	<b>HALSEY</b> , DUROGRIP Nadelhalter	307, 308
<b>GREEN-ARMYTAGE</b> , Uterus-Klemmzangen	730, 731	Nadelhalter	299
<b>GREENE</b> , Wundhaken	406	<b>HALSTED</b> , Arterienklemmen	225
<b>GREGORY</b> , Profundaklemmen	798	<b>HALSTED-MOSQUITO</b> Arterienklemmen	220, 226
<b>GREY-TURNER</b> , Arterienklemmen	227	Halter, Bauchdecken-	482, 483, 485-495
Griffe, Saug-	1092	Handbohrapparate	1052-1054
Skalpell-	38-41, 44, 45, 618	Handbohrfutter	1064
<b>GROSS</b> , Korn- und Tupferzangen	10, 185	Handdermatome	34, 35
Waschzangen	10	Handfixierplatte	1049
<b>GRUENWALD</b> , Pinzetten, bajonettförmig	166	Handgriffe, Elektroden-	506-508, 513
DUROGRIP Pinzetten	164	modular	959
<b>GULEKE</b> , Hohlmeißelzangen	1030	Harnröhrenbougies	629, 630
<b>GUTHRIE</b> , Haut- und Wundhäkchen	360	<b>HARRINGTON</b> , Lungenspatel	878
<b>GUYON</b> , Atraumatische Nierenklemmen	608	Wundhaken	422
Metallbougie-Öffner	630	<b>HARRINGTON-PEMBERTON</b> Lungenspatel	879
Nierenklemmen	608-610	Wundhaken	423
<b>GWILLIAM</b> , Hysterektomieklemmen	266	<b>HARTMANN</b> , Atraumatische Darmklemmen	548
Gynäkologiescheren	117-121	Darmklemmen	548
		Stimmgabeln	6
		Watteträger	351
<b>H</b>		<b>HARVEY</b> , Draht- und Blehscheren	129, 1073
Haarschneidemaschinen, elektrische-	9	Drahtschneidezangen	1074
<b>HAASE</b> , Repositionszangen	1014	<b>HARVEY JACKSON</b> , Laminektomie-	470
<b>HABERER</b> , Bauch- und Darmspatel	450	<b>HASSON</b> , Wundhaken	428
Häkchen, Dura-	360-363	Hauthäkchen	360-363
Explorations-	359	Hautkralle	363
Gefäß-	356-359	Hautspreizer	473
Haut-	360-363	Hautstanzen	33
Nerv-	356-359	<b>HEANEY</b> , Atraumatische Hysterektomie- und Vaginalklemmen	267
Samenstrang-	625	DUROGRIP Nadelhalter	315
Tracheal-	364-366	Hysterektomieklemmen	261
Hämmer	992-996	Nadelhalter	302
Hämorrhoidal-Fasszangen	585	Scheidenspekula	652
Hämorrhoidal-Kanülen	587	Uterusküretten	711
		Wundhaken	652



# Alphabetischer Index – Alphabetical Index

H - J

A - Z

	Seite		Seite
<b>HEANEY MODIF.</b> , Hysterektomieklemmen	261	Hohlsonden	342, 929
<b>HEANEY-BALLENTINE</b> , Hysterektomieklemmen	262	Hohlsonden, Führungs-	336-338
<b>HEANEY-REZEK</b> , Hysterektomieklemmen	261	<b>HOHMANN</b> , Knochenheber	940
<b>HEATH</b> , Hämmer	996	<b>HOHMANN-ALDINGER</b> , Knochenheber	943
Klammerentfernungszangen	352	<b>HOLZBACH</b> , Bauchdeckenhalter	483
Hebel, Knochen-	932-945, 947-959	Hysterektomieklemmen	265
Luxations-	945	<b>HOPT</b> , Atraumatische Klemmen für Nieren- und Pankreaseingriffe	796
Heber, Myom-	690	Hornhautpinzetten	151
<b>HEGAR</b> , DUROGRIP Nadelhalter	310	<b>HOUSE</b> , Saug- und Spülkanülen	1104
Nadelhalter	302	Saugadapter	1099
Uterus-Dilatatoren	662-664	<b>HOWARTH</b> , Raspatorien	964
<b>HEGAR-MAYO</b> , DUROGRIP Nadelhalter	310	<b>HUDSON</b> , Chirurgische Pinzetten	170
<b>HEGAR-MAYO-SEELEY</b> , DUROGRIP Nadelhalter	309	Feine anatomische Pinzetten	151
<b>HEGAR-OLSEN</b> , DUROGRIP Nadelhalter mit Schere	311	Handbohrapparate	1052
Nadelhalter mit Schere	304	Trepansfräser	1052
<b>HEGAR-OLSEN MODIF. LANGE</b> , DUROGRIP Nadelhalter mit Schere	311	<b>HUDSON DOWNS</b> , Handbohrapparate	1053
<b>HEGENBARTH</b> , Klammeranlegepinzetten	352	Trepansfräser	1053
<b>HEIMING</b> , Nierensteinzangen	614	Hüftretraktoren, MIOS-	947-959
<b>HEISS</b> , Arterienklemmen	227	<b>HUMBY</b> , Handdermatom	35
Präparier- und Ligaturklemmen	250	<b>HUNTER</b> , Splitterpinzetten	181
<b>HEISTER</b> , Mundsperrerr	14	<b>HURD</b> , Unterbindungsnadeln	332
<b>HELLBERG/KUPKA</b> , DUROGRIP Nadelhalter	321, 775	Hysterektomieklemmen	260-266, 270
Hemilaminektomiespreizer	469	Hysterektomieklemmen, Atraumatische-	267
<b>HEMINGWAY</b> , Scharfe Löffel	982	Hysterektomiescheren, DUROTIP	100
<b>HENCKEL-TILLEY</b> , Rongeur	900		
<b>HENDERSON</b> , Wundspreizer	465	<b>I</b>	
<b>HENNIG</b> , Gipsspreizer	1087	Iliaca-Klemmen, Atraumatische-	807
<b>HERFF</b> , Blasensprenger	722	Iliaca-Sperrerr	475
<b>HERRICK</b> , Nierenstielklemmen	611	<b>INGE</b> , Wirbelkörperspreizer	481
<b>HERTZLER</b> , Bauchdeckenhalter	485	Instrumente, Tunnelierungs-	853
Rippensperrerr	485, 866	Instrumenten-Öl	1112
<b>HERZ</b> , Sehnenfasszangen	194	Inzisions-Scheren	75
<b>HESS</b> , Nervwurzelhaken	376	Irisscheren	61, 64
<b>HEY GROVES</b> , Knochenhalte-zangen	1022	<b>IRWIN</b> , Wundspreizer	467
<b>HEYWOOD-SMITH</b> , Gallenblasenzangen	594, 595	<b>ISRAEL</b> , Wundhaken	393
Hämorrhoidenklemmen	583	<b>IVES-FANSLER</b> , Anuskope	572
Organ- und Gewebefasszangen	193		
Polypen- und Ovarienzangen	685, 686	<b>J</b>	
Tupfer- und Schwammzangen	192, 193	<b>JACKSON</b> , Scheidenspekula	650
Zungenzange	16	Sehnenfasszangen	194
<b>HEYWOOD-SMITH MODIF.</b> , Gallenblasenzangen	596	<b>JACKSON-BURROWS</b> , Chirurgische Pinzetten	177
Hämorrhoidenklemmen	583	Wundspreizer	472
Tupfer- und Schwammzangen	192	<b>JACOBS</b> , Hakenzangen	682
Zungenzange	16	<b>JACOBSON</b> , Arterienklemmen	226
<b>HIBBS</b> , Osteotome	1004	Mikro-Federscheren	52
Retraktor	946	Mikro-Nadelhalter	282, 770
<b>HILL</b> , Raspatorien	965	Scharfe Löffel	981
<b>HÖSEL</b> , DUROGRIP Nadelhalter	324	<b>JÄGER</b> , Hauthäkchen	362
Wundhaken	411, 569	Sehnen- und Kreuzband- Durchzieh-zangen	195
Hohlmeißel	998-1001, 1003, 1007-1011		
Hohlmeißel, Skoliose-Operationen	1008		
Spongiosa-	1010		
Hohlmeißelzangen	860, 1026-1037		

# Alphabetischer Index – Alphabetical Index

J – K

A – Z

	Seite		Seite
<b>JAMESON</b> , Nadelhalter	302	<b>KELLY</b> , Feine Scheren	70
Präparierscheren	79	Plazentar- und Abortuszangen	734
SuperCut Scheren	90	Polypen- und Ovarienzangen	685
<b>JAMESON-WERBER</b> , Präparierscheren	79	Proktoskop	573
<b>JANSEN</b> , Pinzetten, bajonettförmig	165	Sphinkteroskope	572
Hohlmeißelzangen	1028, 1029	Tupfer- und Schwammzangen	193
Raspatorien	972	Wundhaken	415, 439
Scharfe Löffel	981, 982	Zahnfleischscheren	70
<b>JAVID</b> , Carotis Shunt Klemmen	842	<b>KERN-LANE</b> , Knochenhalte­zangen	1020, 1021
<b>JEFFERSON</b> , Feine anatomische Pinzetten	152	<b>KERN-MINI</b> , Knochenhalte­zangen	1021
Feine chirurgische Pinzetten	169	<b>KERPEL</b> , Scharfe Löffel	983
Wundspreizer	464	<b>KERRISON</b> , Stanzen	892, 896-898
<b>JENKNER</b> , Tunnelierungs- und Durchzugsinstrumentarium für Gefäßprothesen	853	<b>KERSTING</b> , Atraumatische Rektum-Anastomosenklemmen	564
<b>JOHNS-HOPKINS</b> , Anlege- und Abnehmezangen	216, 786	<b>KEY</b> , Raspatorien	972
Bulldogklemmen	216, 786	<b>KEYES</b> , Hautstanzen	33
<b>JOLL (FRIEDMAN)</b> , Thyreoid- und Vulva-Spreizer	472, 659	<b>KEYES MODIF.</b> , Hautstanzen	33
<b>JONES</b> , Tuchklemmen	201	<b>KIEBACK</b> , Parametriumscheren	120, 121, 692, 693
<b>JONESCO</b> , Unterbindungs­nadeln	333	Präparier- und Ligaturklemmen	254
<b>JOSEPH</b> , Feine Scheren	61, 70	Ureter-Tunnelier-Klemmen	691
Haut- und Wundhäkchen	362	<b>KIELLAND</b> , Geburtszangen	726
Knochenfeilen	978	<b>KILLIAN</b> , Knochenscheren	116
Plastikmesser	32	Mastdarm-Rektum-Spekula	570
Plastikscheren	70	Raspatorien	964
Raspatorien	961	Sonden	347
SuperCut Scheren	90	<b>KILNER, DUROGRIP</b> Nadelhalter	308
Zahnfleischscheren	70	Feine Präparierscheren	76
<b>JUDD-ALLIS</b> , Organ- und Gewebefasszangen	540	Hauthäkchen	361
		Nadelhalter	300
		Nasenflügelretraktor	363
		Präparierscheren	79
		Wundhaken	377, 383
		<b>KINGS COLLEGE HOSPITAL</b> , Watteträger	349
<b>K</b>		<b>KIRSCH</b> , Wundhaken	405
Kabel, bipolare	532, 533	<b>KIRSCHNER</b> , Bauchdeckenhalter	494, 495
monopolare	506, 513, 522	Bohrdrähte	1058, 1059
<b>KADER</b> , Bauch- und Darm­spatel	451	Extensionsbügel	1060
Kalkulator, Gestations-	720	Führungs Hohlsonden	338
<b>KALLMORGEN</b> , Scheidenspekula	646	Klammeranlegepinzetten	352
<b>KANTROWITZ</b> , Präparier- und Ligaturklemmen	252	Klammerentfernungszangen	352
Kanülen, Gefäß-Spül-	846	Klammern, Knochenhalte-	1025
Hämorrhoidal-	587	Sterilisier-	207
Koagulations-	1105	Wund-	352
Pudendus­anästhesie-	721	<b>KLAPP</b> , Sehnenscheidenhaken	373
Saug-	885, 886, 1091-1102, 1104, 1105	Kleiderscheren	132-135, 1082
Spül-	598, 886, 1104	<b>KLEINERT-KUTZ</b> , Hauthäkchen	361
Sternumpunktions-	634, 855	Sehnendurchzieh­zangen	195
Uterus-	716, 717	<b>KLEINSCHMIDT</b> , Appendektonmieklemmen	557
Kapsel­fasszangen, Atraumatische-	622	Klemmen, Anastomosen-	559, 560, 843
Kapselscheren	89	Appendektomie-	557
Katheter, Urologie-	627	Arterien, Feine-	220-230
Uterusspül-	717	Arterien-	231-241
Kathetereinführungszangen	15	Atraumatische Anastomosen-	791-793, 799, 808, 822, 823, 825, 828-831
<b>KAZANJIAN</b> , Knochensplitterzangen	1038	Atraumatische Aorta-	811, 816, 817, 832
Kehlkopfspiegel	5		
<b>KELLY</b> , Arterienklemmen	221		



## Alphabetischer Index – Alphabetical Index

K

	Seite		Seite
Klemmen, Atraumatische Aorta-Anastomosen-	818, 819	Klemmen, Quetsch-	558
Atraumatische Aorta-Aneurysma-	813-815	Rektum-Anastomosen-	561, 562
Atraumatische Bronchus-	812	Samenstrang Fixier-	625
Atraumatische Bulldog-	218, 219, 788-790, 820, 821	Schlauch-	17
Atraumatische Coarctations-	804, 826, 827	Sinus-	184
Atraumatische Darm-	547, 548, 550, 552, 555	Tonsillen-	240
Atraumatische Druck-	560, 612	Tuch-	201-206
Atraumatische Gefäß-	794, 795, 801-803	Ureter-Tunnelier-	691
Atraumatische Hämorrhoiden-	584	Venenkomplex-	619
Atraumatische Hysterektomie-	267	Winkel-	612
Atraumatische Iliaca-	807	Klemmenhalter	559
Atraumatische Ligatur-	797, 798	Klemmzangen	273
Atraumatische Magen-	557	Klemmzangen, Atraumatische-	272
Atraumatische Mehrzweck-	791-793, 809, 810, 823- 825, 828, 833, 834	Uterus-	730, 731
Atraumatische Nieren-	608, 796	<b>KLIMA-ROSEGGER</b> Sternal-Punktionskanülen	634
Atraumatische Nierenstiel-	612	Klingen, Mikrochirurgische-	45
Atraumatische Pankreas-	796	Skalpell-	42, 43
Atraumatische Parametrium-	100, 268, 269	<b>KLINIKUM BERLIN</b> , Schlauchklemme	16
Atraumatische Patent-Ductus-	805, 806, 826, 827	<b>KLINKENBERG-LOTH</b> Gefäßscheren	115
Atraumatische Peripheral-	805-807	Knochenbiopsie-Instrumente	1057
Atraumatische Präparier-	797, 798	Knochenbohrer	1055
Atraumatische Profunda-	798	Knochendeckelelevatoren	930
Atraumatische Rektum-Anastomosen-	563, 564, 566	Knochenfeilen	978-980
Atraumatische Vena-Cava-	800	Knochenhaken	387, 388
Atraumatische Winkel-	612	Knochenhalteklammern	1025
Beschneidungs-	631	Knochenhaltezangen	1016-1024
Bipolare-	531	Knochenhaltezangen, selbstzentrierend	1023
Bronchus-	845	Knochenhebel	932-945, 947-959
Bulldog-	216, 217, 786, 787	Knochenraspeln	978-980
Carotis Shunt-	842	Knochenraspeln, DUROGRIP	979
Cholezystektomie-	592	Knochenscheren	116
Colectomie-	554	Knochensplitterzangen	859, 1038-1042
Cystikus-	591, 593	Knochenstanzen	892-898
Darm-	547-551, 553-555	Knochenstanzen, NOIR	897
Darm-Zwillings-	556	Knöchelfasszangen	1016
Druck-	584, 612	Knopfsonden	345, 346
Faden-	213	Knorpelmesser	29, 918
Fixier-	842	Knorpelritzmesser	32
Gallengang-	590	Knorpelscheren	81
Gallenkanal-	590-593	Knorpelzangen	1043
Gefäß-	844	<b>KNOWLES</b> Verbandscheren	131
Hämorrhoiden-	583	Knüpfpinzetten, Mikro-	139, 140, 143
Hysterektomie-	260-266, 270	Koagulationskanülen	521, 1105
Ligatur-	244-256, 840, 841	Koagulationspinzetten, bipolar	523-527
Magen-Zwillings-	556	<b>KOCHER</b> Arterienklammern	235
Monopolare-	520	Atraumatische Darmklammern	552
Nabelschnur-	724	Darmklammern	549, 551
Nieren-	608-610	Führungs-Hohlsonden	337
Nierenstiel-	611, 612	Knochen- und Wundhaken	387
Parametrium-	270, 271, 692, 693	Kropflöffel	453
Penis-	625	Unterbindungsadeln	335
Peritoneum-	257-260	Wund- und Venenhaken	374
Präparier-	244-256, 619, 840, 841	Wundhaken	390, 403, 409
		<b>KOCHER-LANGENBECK</b> Wundhaken	396

A-Z

# Alphabetischer Index – Alphabetical Index

K – L

A – Z

	Seite		Seite
<b>KOCHER-OCHSNER</b> Arterienklemmen	236	<b>LAMBERT-KAY</b> , Atraumatische Aorta-Anastomosenklemmen	819
<b>KOCHER-WAGNER</b> Wundhaken	410	<b>LAMBOTTE</b> , Knochenhaltezangen	1024
<b>KÖNIG</b> , Elevatorien	930	Osteotome	1001, 1005
Führungs-Hohlsonden	337	Raspatorien	973
Raspatorien	960	Rippenraspatorien	863
Wund- und Venenhaken	374	Laminektomie-Wundspreizer	468-471, 476
<b>KÖRTE</b> , Wundhaken	392, 436	Laminektomiespreizer	477, 478
<b>KÖRTE-WAGNER</b> Wundhaken	392	<b>LANCASTER</b> , Lidsperrer	458
<b>KOFLER</b> , Stanzen	894	<b>LANDAU</b> , Scheidenspekula	653
<b>KOGAN</b> , Endospekula für Harnröhre und Cervix	667	<b>LANDOLT</b> , Eukleationsscheren	77
Komprimeter	916	Koagulations-Saugkanülen	521, 1105
Konisationsmesser	696	Präpariersauger	1103
Kontraktoren, Rippen-	877	Raspatorien	969
Kopfschwartzangen	731	Skalpelloffgriff	45
Kornzangen	10, 184-189	Tumorfasszangen	909
<b>KRÄMER</b> , Ligamentum-flavum-Fasszangen	913	<b>LANDON</b> , Scheidenspekula	651
Osteophytenmeißel	998	<b>LANE</b> , Chirurgische Pinzetten	176
Raspatorien	971, 972	Knochenhaltezangen	1020, 1021
Rongeur	909	Knochenheber	933
Wundhaken	407	Magen- und Darm-Zwillingsklemmen	556
<b>KRAUSE</b> , Biopsieaufsatz	705	Organ- und Gewebefasszangen	543
<b>KRAYENBÜHL</b> , Nerv- und Gefäßhäkchen	358	Tuchklemmen	202
<b>KRISTELLER</b> , Scheidenspekula	641-645, 647	Wundhaken	384
<b>KRÖNLEIN</b> , Arterienklemmen	231	<b>LANE TRETOWAN</b> , Knochenheber	933
<b>KRONECKER</b> , Unterbindungsnadeln	329	<b>LANG-STEVENSON</b> , Darmklemmen	554
Kronenspieß	1015	<b>LANGE</b> , Fistelhaken	372
Kropflöffel	453	<b>LANGE-HOHMANN</b> , Knochenheber	934
Krypthaken	579	<b>LANGE-HOHMANN MODIF.</b> , Knochenheber	935
<b>KÜMMEL</b> , Wundhaken	436	<b>LANGENBECK</b> , Amputationsmesser	28, 29
Küretten	989	Amputationssägen	923
Küretten, Abortus-	713	DUROGRIP Nadelhalter	322
Endometrium-, Biopsie-	698	Elevatorien	931
Plazenta-	713	Knochenhaltezangen	1018
Uterus-	708-711	Knorpelmesser	29
Vakuum-	714, 1090	Lappenmesser	28, 917
<b>KÜSTNER</b> , Hakenzangen	681	Raspatorien	971, 972
Kugelelektroden	510, 511, 513	Resektionsmesser	29, 918
		Rippenraspatorien	863
		Wundhaken	394, 395, 398
<b>L</b>		<b>LANGENBECK-GREEN</b> Wundhaken	370
<b>LA GRANGE</b> , Feine Scheren	69	<b>LANGENBECK-MANNERFELTMODIF.</b> , Wundhaken	368
Zahnfleischscheren	69	mit Treangle-Griff	
<b>LABORDE</b> , Trachealdilatatoren	474	Lanzettenelektroden	509
Laborschalen	1108	Lappenmesser	28, 917
Lagerung für Uterus-Dilatatoren	665, 666	<b>LATHBURY-FARRELL</b> , Watteträger	348, 350
<b>LAHEY (SWEET)</b> , Gallengang-Klemmzangen	590	<b>LAWRENCE</b> , Nadelhalter	301
Präparier- und Ligaturklemmen	255	Präparier- und Ligaturklemmen	253
<b>LAHEY</b> , Gallengang-Klemmzangen	590	<b>LAZAR</b> , Mikro-Knüpfpinzetten	140
Hakenzangen	678	<b>LEBSCHÉ</b> , Sternum-Meißel	856
Organ- und Gewebefasszangen	197	Umführungsinstrumente	925
Präparier- und Ligaturklemmen	255	<b>LEECH-WILKINSON</b> Biopsiezangen	704
Wundhaken	404	Uterus-Kanülen	716
		<b>LEES</b> , Atraumatische Bronchusklemmen	812



# Alphabetischer Index – Alphabetical Index

L – M

A-Z

	Seite		Seite
<b>LEGUEU</b> , Blasenspatel	496, 617	Löffel, Scharfe-	981-989
<b>LEITZ</b> , Atraumatische Anastomosenklemmen	828	Sekret-	626
<b>LEKSELL</b> , Hohlmeißelzangen	1033	Ureter-	691
<b>LEKSELL-STILLE</b> , Hohlmeißelzangen	1034	Uterus-	707
<b>LELAND-JONES</b> , Atraumatische Peripheralklemmen	807	Uterus-Sekret-	697
<b>LEMPERT</b> , Hohlmeißelzangen	1029	<b>LOGAN MODIF. REILL</b> , Wundspreizer	457
Raspatorien	962	<b>LOPEZ-REINKE</b> , Tonsillen-Saugdissektoren	1103
Scharfe Löffel	985	<b>LORNA</b> , Tuchklemmen	205
<b>LERICHE</b> , Arterienklemmen	223	<b>LOUTE</b> , Drahtspanner	1065
Wundhaken	435	<b>LOVE-GRUENWALD</b> , Rongeure	902, 906, 907
<b>LEWIN</b> , Knochenhalteklammern	1025	<b>LOWER</b> , Gallenkanal-Klemmzangen	590
<b>LEWIS</b> , Knochenraspeln	978	Präparier- und Ligaturklemmen	255
<b>LEXER, DUROTIP</b> Präparierscheren	95, 101	<b>LOWMAN</b> , Knochenhalteklammern	1025
Hohlmeißel	1008	<b>LOWMAN-GERSTER</b> , Knochenhalteklammer	1025
NOIR Präparierscheren mit Wellenschliff	107	<b>LOWMAN-HOGLUND</b> , Knochenhalteklammer	1025
Osteotome	1008, 1010	<b>LUCAE</b> , Pinzetten, bajonettförmig	165
Präparierscheren	85	Stimmgabel	6
Spongiosa-Hohlmeißel	1010	<b>LUCAS</b> , Flachmeißel	1001
<b>LEXER-MINI</b> , Hohlmeißel	1007	Hohlmeißel	1001
Osteotome	1007	Scharfe Löffel	982
<b>LICHTENBERG, DUROGRIP</b> Nadelhalter	324	<b>LUER</b> , Hämorrhoidenklemmen	583
Lidsperrer	458	Hohlmeißelzangen	1027, 1028, 1030
Ligamentum-flavum-Fasszangen	913	Wundhaken	379
Ligatoren, Hämorrhoidal-	585, 586	<b>LUER-FRIEDMANN</b> , Hohlmeißelzangen	1026
Ligatur, Titanclip	738, 740, 742, 744	<b>LUER-KÖRTE MODIF.</b> , Gallensteinlöffel	602
Ligatur-Gummiringe	585	<b>LUER-STILLE</b> , Hohlmeißelzangen	1035, 1036
Ligaturklemmen	244-256, 840, 841	Lungenfasspinzetten	180, 838
Ligaturklemmen, Atraumatische-	797, 798	Lungenfasszangen	838, 839
Ligaturplättchen	1065	Lungenspatel	422, 423, 425, 426, 878, 879, 881
Ligaturscheren	128	Luxationshebel	945
Ligaturscheren, DUROTIP	104		
<b>LISTER</b> , Sinusklemmen	184		
Verband- und Kleiderscheren	132, 133, 1082		
<b>LISTON</b> , Amputationsmesser	28, 917		
Knochensplitterzangen	1039, 1041	<b>M</b>	
<b>LISTON-KEY-HORSLEY(TUDOR EDWARDS)</b> ,	859, 1042	<b>MAC DONALD</b> , Raspatorien	964
Knochensplitterzangen	859, 1042	Magen-Zwillingsklemmen	556
<b>LISTON-STILLE</b> , Knochensplitterzangen	859, 1042	Magenklemmen, Atraumatische-	557
<b>LITTLER</b> , Präparierscheren	76	Magenquetschklemmen	558
<b>LITTLEWOOD</b> , Hakenzangen	683	<b>MAGILL</b> , Kathetereinführungszangen	15
<b>LLOYD-DAVIES</b> , Biopsiezangen für Rektum	580	Saugkanülen	1100
Proktoskope	575	<b>MAIER</b> , Korn- und Tupferzangen	187
Rektum-Anastomosenklemmen	562	<b>MAINGOT</b> , Hysterektomieklammern	260
Sigmoidoskope	575	<b>MALTZ</b> , Knochenraspeln	978
<b>LLOYD-DAVIES (GOLIGHER'S)</b> , Rektumscheren	125, 565	Mamillenmarkierer	8
<b>LOCKHART-MUMMERY</b> , Fistelsonden	343, 579	Mammariasperrer	876
<b>LOCKLIN</b> , Feine Scheren	69	<b>MANNERFELT MODIF.</b> , Hohlmeißel	998
Zahnfleischscheren	69	Osteotome	998
<b>LOCKWOOD</b> , Darmfasszangen	541	Raspatorien	967
Löffel, Abortus-	712	Sattelhaken	369
Gallenstein-	602	Sehnen-Doppelhaken	369
Geburts-	730	Spatel	369
Kropf-	453	Wundhaken mit Treangle-Griff	367-369
Plazentar-	712	<b>MARBURG</b> , Drahtbiegezeuge	1069

# Alphabetischer Index – Alphabetical Index

## M

	Seite		Seite
Markierer, Mamillen-	8	<b>MC KISSOCK</b> , Raspatorien	971
<b>MARQUARDT</b> , Hohlmeißelzangen	1032	<b>MEAD</b> , Hämmer	992
<b>MARTIN</b> , Beckenzirkel	720	Hohlmeißelzangen	1029
Hakenzangen	677	Raspatorien	966
Meniskus- und Knorpelzangen	1043	<b>MEHDORN</b> , Anlegepinzetten für Gefäßclips	210
Scheidenspekula	655	Gefäßclips	210
Uterussonden	670	Mehrzweckklemmen, Atraumatische-	791-793, 809, 810, 823-825, 828, 833, 834
Wundhaken	417	Meißel, Flach-	998-1003, 1006, 1007, 1010
<b>MARTINI</b> , Scharfe Löffel	981	Hohl-	998-1001, 1003, 1007-1011
<b>MASING</b> , DUROGRIP Nadelhalter	307	Hohl-, Spongiosa-	1009
Knorpelritzmesser	32	Osteophyten-	962, 998
Wund- und Venenhaken	373	Spongiosa Hohl-	1010
Maßbänder	7	Sternum-	856
<b>MASSON</b> , DUROGRIP Nadelhalter	318	Wirbelsäulen-	1009
Nadelhalter	303	Meniskushaken	399, 400, 1045
<b>MASSON-LUETHY</b> , Nadelhalter	303	Meniskussmesser	1044
Mastdarm-Rektum-Spekula	570, 571	Meniskuszangen	1043
<b>MATHIEU</b> , DUROGRIP Nadelhalter	325	Mercedes Sperrer	874
Fremdkörperzangen	626	Messbecher	1108
Mastdarm-Rektum-Spekula	571	Messer, Amputations-	28, 29, 917, 918
Nadelhalter	305	Beinhaut-	29, 918
Scheidenspekula	649	Faden-	43
Wundhaken	385	Fistel-	30
<b>MATHIEU-STILLE</b> , Nadelhalter	305	Gips-	1082
<b>MAYFIELD</b> , Hohlmeißelzangen	1032	Knorpel-	29, 918
<b>MAYO</b> , DUROTIP Präparierscheren	94, 101	Knorpelritz-	32
Gallengangsonden	598	Konisation-	696
Präparierscheren	82, 83, 86	Lappen-	28, 917
Sterilisierklammern	207	Meniskus-	1044
SuperCut Scheren	91	Phalangen-	29, 918
Uterussonden	670	Plastik-	32
<b>MAYO-ADAMS</b> , Wundspreizer	465	Resektions-	29, 918
<b>MAYO-HARRINGTON</b> , Präparierscheren	84	Tonsillen-	31
<b>MAYO-HEGAR</b> , Nadelhalter	301, 302	Trigeminus-	31
<b>MAYO-LEXER</b> , DUROTIP Präparierscheren	95, 101	Zwischenknochen-	918
NOIR Präparierscheren	105	Messerelektroden	509, 511
NOIR Präparierscheren mit Wellenschliff	107	Messschieber	8
Präparierscheren	85	Metallgefäß für Markierungsflüssigkeit	8, 25
<b>MAYO-NOBLE</b> , Muskelscheren	84	<b>METZENBAUM</b> , DUROTIP Präparierscheren	97, 98, 102, 103
Präparierscheren	84	Feine Präparierscheren	62
<b>MAYO-ROBSON</b> , Atraumatische Darmklemmen	555	NOIR Präparierscheren	105
Darmklemmen	555	NOIR Präparierscheren mit Wellenschliff	107
<b>MAYO-STILLE</b> , Präparierscheren	82, 83	Präparierscheren	87
<b>MC CLINTOCK</b> , Plazentar- und Abortuszangen	735	SuperCut Scheren	91
<b>MC CLURE</b> , Mikro-Federscheren	48	<b>MEYER</b> , Repositionszangen	1015
<b>MC GIVNEY</b> , Hämorrhoidal-Fasszangen	585	<b>MEYERDING</b> , Wundhaken	371, 416
<b>MC INDOE</b> , Feine anatomische Pinzetten	154	<b>MICHEL</b> , Kehlkopfspiegel	5
Feine chirurgische Pinzetten	172	Klammeranlegepinzetten	352
Hauthäkchen	361	Klammerentfernungszangen	352
Knochensplitterzangen	1040	Rhinoskopiespiegel	5
Monopolare Pinzetten	517	Wundklammern	352
<b>MC KENTY</b> , Raspatorien	960	<b>MICHEL MODIF.</b> , Klammeranlege- und Klammerentfernungszangen	352
<b>MC KENZIE</b> , Trepanationsbohrer	1052, 1053		
Trepanationsfräser	1053		





## Alphabetischer Index – Alphabetical Index

M – N

A – Z

	Seite		Seite
<b>MICRO-ADSON</b> , Feine anatomische Pinzetten	151, 152	<b>MOYNIHAN</b> , Gallengang-Klemmzangen	592
Feine chirurgische Pinzetten	168, 169	Gallengangsonden	598
Präparier- und Ligaturklemmen	244	<b>MÜHLING</b> , Knochenschere	116
<b>MICRO-ADSON-BIEMER</b> , Feine chirurgische Pinzetten	168	Raspatorien	969
<b>MICRO-HALSTED</b> , Arterienklemmen	220	<b>MÜLLER</b> , Atraumatische Gefäßclips	214, 215, 784, 785
<b>MIDDELDORPF</b> , Wundhaken	406	Atraumatische Rektum-Anastomosenklemmen	566
Mikro-Fadenschere	60, 768	DUROGRIP Nadelhalter	317, 568
Mikro-Federschere	48-53, 55-60, 747, 749, 768	DUROGRIP Nahtpinzetten	178
Mikro-Knüpfpinzetten	139, 140, 143	Fadenklemmen	213
Mikro-Nadelhalter	282-285, 770-772	Gefäßclips	213
Mikro-Nadelhalter, DIADUST	289, 291, 293, 295-297, 759, 761, 763, 765-767, 769	Hauthäkchen	361
DUROGRIP	286, 287, 773, 774	Mikro-Federschere	55
Mikro-Pinzetten	141, 142, 145, 147, 150, 769	Mikro-Nadelhalter	285
Mikro-Pinzetten, DIADUST	753, 755, 757, 769	Mikro-Pinzetten	141, 142
Mikro-Präparierschere	53	Rektumschere	127, 567
Mikro-Skalpelle	24	Wundhaken	442
Mikro-Skalpellgriffe	44, 45	Mundsperrerr	14, 15
Mikro-Venenschere	51	<b>MURPHY</b> , Stirnband	2
Mikrochirurgische Klappen	45	Wundhaken	391
<b>MIKULICZ</b> , Peritoneumklemmen	257-259	<b>MURPHY-LANE</b> , Luxationshebel	945
Tonsillenklemmen	240	<b>MUSEUX</b> , Hakenzangen	678, 683, 684
Wundhaken	437, 438	Organ- und Gewebefasszangen	197
<b>MILLER</b> , Knochenraspeln	979	Muskelschere	84
<b>MILLES</b> , Mikro-Federschere	52	Myomheber	690
<b>MILLIN</b> , Atraumatische Kapselasszangen	622	Myrtenblattsonden	344
Blasenhalsspreizer	622		
Blasewundspreizer	496, 617		
Fadenhaltezzangen	326, 622		
<b>MILLS</b> , Gallengangschere	597	<b>N</b>	
MIOS, Hüftretraktoren	947-959	<b>NABATOFF</b> , Venenstripper	887
<b>MITCHELL</b> , Raspatorien	973	Nabelschnurdilatatoren	724
<b>MIXTER</b> , Präparier- und Ligaturklemmen	841	Nabelschnurklemmen	724
Gallenkanal- und Cystikusklappen	593	Nabelschnurschere	123, 723
Präparier- und Ligaturklemmen	253, 255, 841	Nadel, Schleimhaut-Resektion-	515
<b>MIXTER-O'SHAUGNESSY</b> , Präparier- und Ligaturklemmen	249	Nadeldosen	279
<b>MOD. BERLIN</b> , Endometrium-Biopsieküretten	698	Nadelelektroden	509-513
<b>MOD. MÜNCHEN</b> , Endometrium-Biopsieküretten	698	Nadelhalter	299-303, 305
<b>MOD. USA</b> , Gipsspreizer	1087	Nadelhalter, Bumerang-	326, 623
Modularer Handgriff	959	DIADUST	289, 291, 293, 295-298, 759, 761, 763, 765-767, 769
<b>MOLLISON</b> , Wundspreizer	464	DUROGRIP	286, 287, 307-310, 312-325, 568, 773-779
<b>MOLT</b> , Raspatorien	966	Mikro-	282-287, 289, 291, 293, 295-297, 759, 761, 763, 765-767, 769-774
Monopolare Anschlusskabel	506, 513, 522	mit Schere	304
Monopolare Elektroden	509-511	mit Schere, DUROGRIP	311
Monopolare Handgriffe	506, 508, 513	Nadeln	328
Monopolare Klemmen	520	Nadeln, Chirurgische, Näh-	276-278
Monopolare Pinzetten	516-519	Drahtumführungs-	1066
Monopolare Schere	515	Führungs-	353
<b>MORRIS</b> , Atraumatische Aortaklemmen	811	Unterbindungs-	329-336, 1056
Atraumatische Rektum-Anastomosenklemmen	563	Nägel	1063
Wundhaken	415	<b>NÄGELE</b> , Geburtszangen	726
<b>MORSE</b> , Sternumsperrerr	872	Nähnadeln, Chirurgische-	276-278
<b>MOYNIHAN</b> , Arterienklemmen	223, 239		
Darmklemmen	553		

# Alphabetischer Index – Alphabetical Index

N – P

A – Z

	Seite		Seite
Nagelausreißzangen	1079	<b>O</b>	
Nagelfeilen	13	<b>O'SHAUGNESSY</b> , Präparier- und Ligaturklemmen	249, 252
Nagelhautscheren	12, 64	<b>OBWEGESER</b> Ahlen	1056
Nagelscheren	11, 13, 130	Osteotome	1005
Nagelspaltscheren	75, 1079	Wundhaken	401, 402
Nagelspaltzangen	1079	<b>OCHSNER</b> , Atraumatische Aortaklemmen	817
Nagelzangen	12	Fadenpinzette	158
Nahtpinzetten, DUROGRIP	163, 178	Gallengangsonden	599
Nasenflügelretraktor	363, 370	Öl, Instrumenten-	1112
Nasenflügelscheren	77	Ösenrinnensonden	343
Nasenpinzetten	165-167	<b>OFFICER</b> , Chirurgische Pinzetten	176
Nasenplastikscheren	77	Offset-Scheren	111
Nasensonden	347	Ohrhäkchen, stumpf	356
Nasentamponzangen	184	<b>OLDBERG</b> , Rongeur	908
<b>NAUNTON MORGAN</b> , DUROGRIP Nadelhalter	317	<b>OLIVECRONA</b> , Drahtsägen	924
Rektum-Spekula mit Kaltlicht	574	Hohlmeißelzangen	1030
<b>NEGUS</b> , Saugdissektoren	1103	Trigeminusmesser	31
Tonsillenklemmen	240	<b>OLLIER</b> , Wundhaken	394
<b>NELATON</b> , Hohlsonden	342	<b>OMBREDANNE</b> , Hämmer	996
<b>NELSON</b> , Lungenfasspinzetten	180, 838	Organfasszangen	190, 192, 193, 197-199, 540, 543
<b>NELSON-METZENBAUM</b> DUROTIP Präparierscheren	97, 102, 103	Organfasszangen, Atraumatische-	191, 544, 545, 835-837
Präparierscheren	88	<b>ORMROD-SCHMITT</b> , Ligaturplättchen	1065
<b>NELSON-METZENBAUM (MC INDOE)</b> ,	98	Osteophytenmeißel	962, 998
DUROTIP Präparierscheren		Osteotome	998, 999, 1001-1008, 1010
Nerv-Approximator	212	Osteotome, Fischschwanz-	1001
Nerv-Präparierscheren	63, 79	Ovarienzangen	685-688
Nervhäkchen	356-359	Ovarienzangen, Atraumatische-	687
Nervwurzelhaken	376	<b>OVERHOLT</b> , Präparier- und Ligaturklemmen	247
Netzgerät	3	<b>OVERHOLT-GEISSENDOERFER</b> Präparier-	246
<b>NIEDERDELLMANN</b> Osteotome	1005	und Ligaturklemmen	
Nierenfasszangen	613	<b>OVERHOLT-MIXTER</b> Präparier- und Ligaturklemmen	246
Nierenklemmen	608-610	<b>O'CONNELL</b> , Dissektoren	929
Nierenklemmen, Atraumatische-	608, 796	<b>O'SULLIVAN-O'CONNOR</b> Bauchdeckenhalter	489
Nierenschalen	1108		
Nierensteinzangen	614-616	<b>P</b>	
Nierenstielklemmen	611, 612	Pankreasklemmen, Atraumatische-	796
Nierenstielklemmen, Atraumatische-	612	Parametriumklemmen	270, 271, 692, 693
<b>NISSEN</b> , Arterienklemmen	225	Parametriumklemmen, Atraumatische-	100, 268, 269
Gallenkanal- und Cystusklemmen	591	Parametriumscheren	120, 121, 692, 693
Präparier- und Ligaturklemmen	245, 256	<b>PARKER</b> , Wundhaken	379, 380
<b>NOIR</b> , Präparierscheren	105	<b>PARKER-KERR</b> , Anastomoseklemmen	560
Präparierscheren mit Wellenschliff	106, 107	<b>PARRY-COOLEY</b> , Atraumatische Anastomosenklemmen	830
<b>NORFOLK and NORWICH</b> , Laminektomie-Wundspreizer	468	<b>PARTSCH</b> , Flachmeißel	1000
<b>NORTHBENT</b> , Ligaturscheren	128	Hohlmeißel	1000
<b>NORTHFIELD</b> , Hohlmeißelzangen	1031	Raspatorien	960
<b>NOTO</b> , Organ- und Gewebefasszangen	193	<b>PARTSCH MOD. LANGE</b> , Raspatorien	960
Polypen- und Ovarienzangen	686	<b>PASSOW</b> , Stößel	997
Tupfer- und Schwammzangen	193	Patellazangen	1016
<b>NOVAK-SCHOECKAERT</b> , Endometrium-Biopsieküretten	698	Patent-Ductusklemmen, Atraumatische-	805, 806, 826, 827
<b>NOYES</b> , Mikro-Federscheren	48	<b>PAUL</b> , Sehnenscheidenhaken	373
<b>NUSSBAUM</b> , Darmklemmen	553	<b>PAYR</b> , Darm- und Magenquetschklemmen	558
		Führungs-Hohlsonden	337



## Alphabetischer Index – Alphabetical Index

P

	Seite		Seite
<b>PEAN</b> , Arterienklemmen	231, 232, 234, 239	Pinzetten, Mikro-	139-143, 145, 147, 149, 753, 755, 757, 769
Atraumatische Gefäßklemmen	795	Monopolare-	516-519
Nierenklemmen	609	Naht-	163, 178
Schlauchklemmen	17	Nasen-	165-167
<b>PEDERSON</b> , Scheidenspekula	640	Splitter-	181
<b>PEET</b> , Splitterzangen	181	Tumor-	179
<b>PELKMANN</b> , Fremdkörperzangen	200	Wundrand-	170
Gallensteinzangen	604	<b>PIPER</b> , Geburtszangen	727
Tamponzangen	672	<b>PITHA</b> , Fremdkörperzangen	200, 626
Pelvishaken	440, 441, 578	Plättchen, Ligatur-	1065
<b>PENFIELD</b> , Dissektoren	928, 929	Plastikmesser	32
Penisklemmen	625	Plastikscheren	70
<b>PENNINGTON</b> , Arterienklemmen	241	Plattenelektroden	510
Darmfasszangen	542	Plazentarküretten	713
<b>PENNYBACKER</b> , Dissektoren	929	Plazentarlöffel	712
Hohlmeißelzangen	1031	Plazentarzangen	732-735
Raspatorien	972	<b>PLESTER</b> , Saugkanülen	1095
Rongeur	903	Wundspreizer	462
<b>PERCY</b> , Amputationsretraktoren	920	<b>POIRIER</b> , Gewebefasszangen	196
Perinealsperrer	577	Polypenzangen	685-688
Peripheralklemmen, Atraumatische-	805-807	Polypenzangen, Atraumatische-	687
Peritoneumklemmen	257-260	<b>POOL</b> , Saugkanülen	1093
<b>PERKINS</b> , Wundspreizer	463	Poplitea-Sperrer	497
<b>PERTHES</b> , Reibahle	1055	<b>POTTS</b> , Präparierscheren	80
<b>PERWITZSCHKY</b> , Speichelgangschere	68	<b>POTTS-DE MARTEL</b> , Gallengangscheren	597
Phalangenmesser	29, 918	Gefäßscheren	110, 111
<b>PHANEUF</b> , Hysterektomieklemmen	260	<b>POTTS-DIETHRICH</b> , Gefäßscheren	108, 109, 751
Phlebextraktoren	889	<b>POTTS-SMITH</b> , Gefäßscheren	111, 114
Phlebdissektoren	889	<b>POZZI</b> , Hakenzangen	674, 676
<b>PICCOLO</b> , Watteträger	348	Präparationshäkchen	376
Pinzetten, Anatomische, Feine-	151-155, 783	Präparierklemmen	244-256, 619, 840, 841
Anatomische-	156-158	Präparierklemmen, Atraumatische-	797, 798
Atraumatische-	160-162, 567, 782, 783	Präpariersauger	1103
Atraumatische-, Ultra-Light	159, 546, 781	Präparierscheren	76-89, 113, 618
Augen-	168	Präparierscheren, Bipolare-	530
Bajonettförmige-	165, 166	DUROTIP	94-99, 101-103
Bipolare-	523-529, 620	Feine-	62, 63, 76, 78, 80, 81
Chirurgische-	168, 170, 173-179	Mikro-	53
Clipanlage-	210, 211	Nerv-	63
Darm-	180, 543	NOIR-	105-107
DIADUST	145, 147, 149, 150, 753, 755, 757, 769	<b>PRATT</b> , Hakenzangen	680
DUROGRIP	162-164, 178, 543	Mastdarm-Rektum-Spekula	571
Faden-	158	Organ- und Gewebefasszangen	198
Feine chirurgische-	168, 169, 171, 172	Uterus-Dilatatoren	663
Fixier-	165	<b>PRICE THOMAS</b> , Bronchusklemmen	845
Gefäß-	179	Profundaklemmen, Atraumatische-	798
Gewebefass-	179, 180, 543	Proktoskope	573, 575
Hornhaut-	151	Prostatatrektor	452, 620
Klammeranlage-	352	<b>PROVIDENCE-HOSPITAL</b> , Arterienklemmen	221
Kniegebogene-	167	Pudendusnadeln	721
Knüpf-	139, 140, 143	Punktionskanülen, Sternum-	855
Lungenfass-	180, 838	<b>PUTTI</b> , Knochenfeilen	980
		Pylorusspreizer	557

# Alphabetischer Index – Alphabetical Index

Q – S

A – Z

## Q

<b>QUERVAIN</b> , Elevatorien	931
<b>QUINBY</b> , Feine Scheren	67
Zahnfleischscheren	67

## R

<b>R.N.O.H.</b> , Biopsie-Instrumente für Knochen	1057
Rabenschnabel	1087
<b>RAGNELL</b> , Feine Präparierscheren	63
Wundhaken	379
<b>RAMPLEY</b> , Tupper- und Schwammzangen	190
<b>RAMSEY</b> , Anatomische Pinzetten	158
Chirurgische Pinzetten	177
<b>RANDALL</b> , Endometrium-Biopsieküretten	698
Nierensteinzangen	614–616
<b>RANKIN</b> , Arterienklemmen	224
Rasierklingenmesser	9
Raspatorien	960–977
Raspatorien, Rippen-	861–863
Saug-	1103
Raspeln, Knochen-	978–980
<b>RECAMIER</b> , Plazentar- und Abortusküretten	713
Uterusküretten	708
<b>REDON</b> -Führungsnadeln	353
Reflektor	2
Reflexspiegel	2
Reibahlen	1055
<b>REILL</b> , Drahtschneidezangen	1076
Mikro-Nadelhalter	284, 772
Repositionszangen	1015
Sehnenstripper	1046
<b>REIN/KUPKA</b> , DUROGRIP Nadelhalter	321, 775
Rektum-Anastomosenklemmen	561, 562
Rektum-Anastomosenklemmen, Atraumatische-	563, 564, 566
Rektum-Spekula	573
Rektum-Spekula, Kaltlicht	574
Rektumbiopsiezangen	580–582
Rektumscheren	125–127, 565, 567
<b>REMLINGTON-HOBB</b> , Monopolare Pinzetten	518
Repositionsstößel	1015
Repositionszangen	1014–1016
<b>RESANO</b> , Atraumatische Rektum-Anastomosenklemmen	564
Kapselscheren	89
Resektionsmesser	29, 918
Retraktoren, Amputations-	920
Hüft-	947–959
MIOS-	947–959
<b>REVERDIN</b> , Bauch- und Darmspatel	450
Nadeln	328
<b>REYNOLDS</b> , Präparierscheren	80
<b>REYNOLDS-JAMESON</b> , Gefäßscheren	63
Rhinoskopie Spiegel	5

Seite

<b>RIBBON</b> , Bauch- und Darmspatel	450
<b>RICARD</b> , Bauchdeckenhalter	483
<b>RICHARDSON</b> , Wundhaken	413, 414
<b>RICHARDSON-EASTMAN</b> , Wundhaken	413
<b>RICHS</b> , Monopolare Klemmen	520
Rippenfasszangen	859
Rippenkontraktoren	877
Rippenraspatorien	861–863
Rippenscheren	857, 858
Rippensperrer	866–871, 877
<b>RNTNE HOSPITAL</b> , Wundspreizer	463
<b>ROBERTS</b> , Arterienklemmen	238
Raspatorien	966
<b>ROBIN</b> , Tuchklemmen	204
<b>ROCHARD</b> , Bauchdeckenhalter	448
Befestigungsgestell für Bauchdeckenhalter	449
Fixiervorrichtung für Bauchdeckenhalter	448
<b>ROCHESTER-CARMALT</b> , Arterienklemmen	237
<b>ROCHESTER-OCHSNER</b> , Arterienklemmen	235
<b>ROCHESTER-PEAN</b> , Arterienklemmen	233
<b>ROEDER</b> , Tuchklemmen	203
Röntgen-Messstäbe	7
<b>RÖTTGEN-RUSKIN</b> , Hohlmeißelzangen	1032
<b>ROLLET</b> , Hauthäkchen	360
Rongeurs	899–912
<b>ROSE</b> , Wundhaken	379
<b>ROSER-KÖNIG</b> , Mundsperrer	15
<b>ROTUNDA</b> , Uterusspül-Katheter	717
<b>ROUX</b> , Wundhaken	381–383
<b>ROWBOTHAM</b> , Saugkanülen	1101
<b>RUMEL</b> , Präparier- und Ligaturklemmen	251
<b>RUMEL-BELMONT</b> , Tourniquets	851
<b>RUSKIN</b> , Hohlmeißelzangen	1032
<b>RUSKIN-LISTON</b> , Knochensplitterzangen	1040
<b>RUSS. MODELL</b> , Chirurgische Pinzetten	179
<b>RUST</b> , Amputationssägen	921
<b>RYDEL-SEIFFER</b> , Stimmgabel	6
<b>RYDER</b> , DIADUST Nadelhalter	298, 767
DUROGRIP Nadelhalter	319, 320, 778, 779

Seite

## S

Sägeblätter	921, 922
Sägen, Amputations-	921–923
Draht-	924
Fingerring-	1079
Gips-	1082
<b>SAENGER</b> , Plazentar- und Abortuszangen	733
Salpingograph	715
Samenstrang Fixierklemmen	625
Samenstranghaken	625
<b>SAROT</b> , Arterienklemmen	229, 238
DUROGRIP, Nadelhalter	309



# Alphabetischer Index – Alphabetical Index

S

A-Z

	Seite		Seite
<b>SATINSKY</b> , Anastomosenklemmen	843	<b>SENN-MILLER</b> Wundhaken	377
Atraumatische Bulldogklemmen	821	Sequesterzangen	1017
Gefäßscheren	115	<b>SEUTIN</b> , Gipspscheren	134, 1084
Sattelhaken	369	<b>SEWALL</b> , Elevatorien	963
<b>SATTERLEE</b> , Amputationssägen	923	<b>SEYFFERT</b> , Scheidenspekula	639
<b>SAUER</b> , Lidsperrer	458	Siebbeinzangen	899-901
<b>SAUERBRUCH</b> , Abfallzange	18	<b>SIEBOLD</b> , Uterusscheren	119
Rippenscheren	857	Sigmoidoskope	575
Wundhaken	404, 425	<b>SILVER</b> , Handdermatom	35
<b>SAUERBRUCH-CORYLLOS</b> Hohlmeißelzangen	860, 1037	<b>SIMON</b> , Fistelhaken	372
Saugdissektoren	1103	Fistelmesser	30
Saugdissektoren, Tonsillen-	1103	Scharfe Löffel	988
Sauger, Präparier-	1103	Scheidenspekula	655
Saugglocken	725	Uteruslöffel	707
Sauggriffe	1092	Wundhaken	417
Sauginstrumente	1098	<b>SIMPSON</b> , Geburtszangen	728
Saugkanülen	885, 886, 1091-1102, 1104, 1105	Uterussonden	671
Saugraspatorien	1103	<b>SIMPSON-BRAUN</b> , Geburtszangen	727
Saugschlauch	714, 1090	<b>SIMS</b> , DUROTIP Uterusscheren	103
<b>SAUNDERS</b> , I.U.D.-Entfernungshaken	697	Gynäkologische Scheren	117, 118
Scapula-Haken	426, 880	Mastdarm-Rektum-Spekula	570, 571
<b>SCOVILLE-HAVERFIELD</b> Laminektomie-Wundspreizer	476	Scheidenspekula	640
<b>SCOVILLE-RICHTER</b> Wund- und Laminektomiespreizer	477	Uterusküretten	709
<b>SCUDDER</b> , Atraumatische Magenklappen	557	Uterusscheren	99, 117, 118
<b>SEBILEAU</b> , Elevatorien	931	Uterussonden	670
<b>SEDILLOT</b> , Raspatorien	971, 973	<b>SIMS-MAIER</b> , Korn- und Tupferzangen	188
<b>SEGOND</b> , Hysterektomieklappen	265	<b>SIMS-SIEBOLD</b> , Uterusscheren	120
<b>SEGOND-LANDAU</b> , Hysterektomieklappen	264	Sinus-Knopfsonden	345
Sehnen-Doppelhaken	369	Sinusklemmen	184
Sehnenziehsonden	1048	Skalpelle	26, 27
Sehnenfazzangen	194, 195	Skalpelle, Mikro-	24
Sehnenscheidenhaken	373	Skalpelle, Einmal-	22-24
Sehnenscheren	78	Steril-	22-24
Sehnenstripper	1046, 1047	Skalpelligriffe	38-41, 618
<b>SEIDEL</b> , Scheidenspekula	641	Skalpelligriffe, Mikro-	44, 45
<b>SEIDL</b> , Biopsiezangen	702	Skalpelliklingen	42, 43
<b>SEIFFERT</b> , Sonden	347	<b>SMILLIE</b> , Meniskusmesser	1044
Seitenschneider	1075, 1076	Wund- und Meniskushaken	399, 1045
Sekretlöffel	626	<b>SMITH</b> , Verbandsscheren	131
Sekretlöffel, Uterus-	697	<b>SMITH-BUIE</b> , Analspreizer	573
<b>SELDIN</b> , Raspatorien	966	<b>SMITH-PETERSEN</b> , Osteomose	1004
<b>SELLHEIM</b> , Geburtslöffel	730	<b>SOMER</b> , Uterusfazzangen	689
<b>SELLORS</b> , Rippenspreizer und -kontraktor	877	Sonden	347
<b>SELMAN</b> , Chirurgische Pinzetten	179	Sonden, Anal-	342, 343, 579
<b>SEMB</b> , Hohlmeißelzangen	860, 1036	Doppelknopf-	346
Knochenhalteclangen	1018	Fistel-	343, 579
Präparier- und Ligaturklappen	840	Gallengang-	598, 599
Raspatorien	975	Hohl-	342, 347, 929
Rippenfazzangen	859	Knopf-	345, 346
Rippenraspatorien	862	Myrtenblatt-	344
<b>SEMKEN</b> , Feine anatomische Pinzetten	154	Nasen-	347
Feine chirurgische Pinzetten	171	Ösenrinnen-	343
<b>SEMM</b> , Bauchdeckenhalter	491	Ohr-	347
Scheidenspekula	639	Sehnenzieh-	1048

# Alphabetischer Index – Alphabetical Index

S – SCH

A-Z

	Seite		Seite
Sonden, Speichelgang-	347	<b>SPURLING</b> , Rongeure	902, 906, 907
Uterus-	670, 671	<b>SUBRAMANIAN (MODIF.)</b> , Atraumatische Aortaklemmen	816
<b>SPACKMAN</b> , Uterus-Kanülen	716	SuperCut Scheren	90, 91
Spatel	369	<b>SWEDISH</b> , Dissektoren	929
Spatel, Bauch-	435, 436, 450, 451	<b>SYME</b> , Raspatorien	966
Blasen-	496, 617	Unterbindungsnadeln	334
Darm-	435, 436, 450, 451	Synovektomie-Zangen	1026
Gefäß-	849, 850	<b>SYPERT</b> , Hohlmeißelzangen	1035
Lungen-	422-425, 878, 879, 881	Rongeure	912
Zungen-	4, 348	Stanzen	895
Speichelgangscheren	68	<b>SYSTRUNK</b> , Nagelspaltscheren	75, 1079
Speichelgangsonden	347		
Spekula, Endo-	667		
Mastdarm-Rektum-	570, 571	<b>SCH</b>	
Rektum-	573	<b>SCHAEDEL</b> , Tuchklemmen	201
Rektum-, Kaltlicht	574	Schalen, Labor-	1108
Scheiden-	636-658	Nieren-	1108
<b>SPENCER</b> , Ligaturscheren	128	Scharfe Löffel	981-989
<b>SPENCER-WELLS</b> Arterienklemmen	232	<b>SCHEDE</b> , Scharfe Löffel	984
Sperrer, Iliaca-	475	Scheidenspekula	636-658
Lid-	458	<b>SCHERBACK</b> , Scheidenspekula	657
Mammaria-	876	Scheren, Anatomie-	68
Mund-	14, 15	Arteriotomie-	80
Perineal-	577	Augen-	49
Poplitea-	497	Bauchdecken-	122
Rippen-	866-871, 877	Bipolare-	530
Sternum-	872, 873, 876	Blech-	129, 1072, 1073
Thorax-	864, 865, 874	Blech-, DuroTIP	1072
Sphinkteroskope	572	Bulldog-	76
Spiegel, Kehlkopf-	5	Chirurgische-	71-75, 82, 93, 101, 122
Reflex-	2	Damm-	124, 724
Rhinoskopie-	5	Darm-	125, 127
Stirn-	2	Draht-	100, 129, 1072, 1073
Spiralbohrer	1054	Draht-, DuroTIP	1072
Splitterpinzetten	181	Dura-	112
Splitterzangen	181	DUROTIP	92-100, 103
Spongiosa-Hohlmeißel	1009	DUROTIP mit Wellenschliff	101-104
Spreizer, Anal-	573, 576	E nukleation-	77
Blasenwund-	496	Faden-	60, 92, 101, 768
Gips-	1087	Feine-	12, 61, 63-70, 92
Haut-	473	Gallenblasen-	596
Hemilaminektomie-	469	Gallengang-	597
Laminektomie-	477	Gefäß-	63, 78, 100, 108-115, 751
Laminektomie-Wund-	468-471, 476, 478	Gips-	134, 135, 1083-1086
Pylorus-	557	Gynäkologie-	117-121
Struma-	472	Hysterektomie-	100
Thyreoid-	472	Inzisions-	75
Vulva-	472, 473, 659	Iris-	61, 64
Wirbelkörper-	481	Kapsel-	89
Wirbelsäulen-	479, 480	Kleider-	132-135, 1082
Wund-	456-467, 472, 477	Knochen-	116
Sprenger, Blasen-	722	Knorpel-	81
Spritzen, Hämorrhoidal-	587	Ligatur-	104, 128
Spülkanülen	598, 886, 1104		



# Alphabetischer Index – Alphabetical Index

SCH - ST

A-Z

	Seite		Seite
Scheren, Mikro-	48-53, 55-60, 747, 749, 768	<b>SCHUHKNECHT</b> , Saugkanülen	1097
mit Wellenschliff	106, 107	<b>SCHULZE</b> , Salpingograph	715
Monopolare-	515	<b>SCHUMACHER MOD. WAGNER</b> , Knochenhebel	943
Muskel-	84	<b>SCHUMACHER</b> , Biopsieaufsatz	705
Nabelschnur-	123, 723	Biopsiezangen	701
Nagel-	11, 13, 130	Knochenhebel	944
Nagelhaut-	12, 64	Nabelschnurscheren	123, 723
Nagelspalt-	75, 1079	Sternum-Scheren	855
Nasenflügel-	77	Schwammzangen	190, 192, 193
Nasenplastik-	77	<b>SCHWEDISCHES MODELL</b> , Anatomische Pinzetten	157
Nerv-Präparier-	63, 79	Schwesternscheren	132
NOIR-	105-107		
Offset-	111	<b>ST</b>	
Parametrium-	120, 121, 692, 693	<b>ST. BARTS</b> , Nerv- und Gefäßhäkchen	356
Plastik-	70	Rongeurs	900, 901
Präparier-	53, 76-89, 94-99, 101-103, 106, 107, 113, 618	<b>ST. MARKS</b> , Pelvishaken	440, 441, 578
Präparier-, Feine-	62, 63, 76, 78, 80, 81	<b>ST. MARKS MODIF. GIRONA</b> , Perinealsperrerr	577
Präparier-, NOIR	105	<b>ST. MARTIN</b> , Chirurgische Pinzetten	168
Rektum-	125-127, 565, 567	<b>STACKE</b> , Sonden	347
Rippen-	857, 858	<b>STAMM</b> , Knochensplitterzangen	1038
Schwestern-	132	Stanzen, Aorten-	852
Sehnen-	78	Haut-	33
Speichelgang-	68	Knochen-	892-898
Sternum-	855, 856	Staubinden	916
Strabismus-	62, 76	<b>STEINMANN</b> , Nägel	1063
SuperCut-	90, 91	<b>STELLBRINK</b> , Synovektomie-Zangen	1026
Uterus-	99, 103, 117-120	<b>STELZNER</b> , Rektumscheren	126, 565
Venen-	51	Sterilisierklammern	207
Verband-	131-133, 1082	Sterilisierrahmen	33, 919
Wundrand-	72	Sterilisierzangen	1109
Zahnfleisch-	12, 64-67, 69, 70, 92	<b>STERILIT</b> , Instrumenten-Öl	1112
Scherköpfe, Elektra II	9	Sterilskalpelle	22-24
Schieber, Mess-	8	<b>STERNBERG</b> , Wundhaken	378
<b>SCHINK</b> , Handdermatom	34	Sternummeißel	856
Schlauchklemmen	17, 18	Sternumpunktionskanülen	634, 855
Schleimhaut-Resektionsnadel	515	Sternumscheren	855, 856
Schließzangen	559	Sternumsperrerr	872, 873, 876
Schlingenelektroden	509, 513	<b>STEVENS</b> , Feine Präparierscheren	62, 78
<b>SCHMELZ</b> , Gestationskalkulator	720	Gefäß- und Sehnnenscheren	78
<b>SCHMID</b> , Gefäß-Spülkanülen	846	<b>STIEGLITZ</b> , Splitterzangen	181
Gefäßspatel	850	<b>STILLE</b> , Flachmeißel	1003
Mundsperrerr	14	Gipsscheren	1086
<b>SCHMIEDEN</b> , Führungs-Hohlsonden	337	Hohlmeißel	1003
<b>SCHMIEDEN-TAYLOR</b> , Durascheren	112	Hohlmeißelzangen	1034
<b>SCHNEIDER-SAUERBRUCH</b> , Raspatorien	973	Nierenklemmen	610
<b>SCHNIDT</b> , Arterienklemmen	240	Osteotome	1003
Tonsillenklemmen	240	Präparierscheren	85
<b>SCHOEMAKER</b> , Colectomie-Klemmen	554	<b>STILLE-AESCLAP</b> , Gipsscheren	1085
<b>SCHOENBORN</b> , Wund- und Venenhaken	375	<b>STILLE-BARRAYA</b> , Gefäß- und Tumorpinzetten	179
<b>SCHRÖDER</b> , Hakenzangen	675, 676, 678, 679	Gewebebspinzetten	543
Organ- und Gewebefasszangen	197, 199	<b>STILLE-RUSKIN</b> , Hohlmeißelzangen	1034
Uteruslöffel	707		
<b>SCHUBERT</b> , Biopsiezangen	699		

# Alphabetischer Index – Alphabetical Index

ST – U

A-Z

	Seite		Seite
Stimmgabeln	6	Trachealhäkchen	364-366, 375
Stirnbänder	2	Transformator	3
Stirnlampen	3	<b>TRAVERS</b> , Wundspreizer	467
Stirnlampen, Zubehör	3	<b>TRELAT</b> , Raspatorien	961
Stirnspiegel	2	Scheidenspekula	638
<b>STOCKMANN</b> , Penisklemmen	625	Trepanationsbohrer	1052, 1053
Stößel	997	Trepanationsfräser	1052, 1053
Stößel, Repositions-	1015	<b>TREVES</b> , Chirurgische Pinzetten	177
Strabismusscheren	62, 76	Trigeminusmesser	31
<b>STRANDELL-STILLE</b> , Sehnenscheidenhaken	373	<b>TROELTSCH</b> , Pinzetten, kniegebogen	167
<b>STRASSBURGER MODELL</b> , Chirurgische Pinzetten	178	Trokare	634
<b>STRATTE</b> , DUROGRIP, Nadelhalter	315	Trokare, Universal-	634
<b>STRAUSS</b> , Penisklemmen	625	<b>TROTTER</b> , Hohlmeißelzangen	1030
Stripper, Endarterektomie-	851	<b>TROUSSEAU</b> , Trachealdilatatoren	474
Nerv-	1046	Tuchklemmen	201-206
Sehnen-	1046, 1047	<b>TUDOR-EDWARDS</b> , Wundhaken	443
Venen-	887, 888	<b>TÜBINGER MODELL</b> , Gallensteinzangen	605
<b>STRUCK</b> , Thoraxsperrer	865	Scheidenspekula	655
<b>STRULLY</b> , Gefäßscheren	112, 113	Wundhaken	417
Strumaspreizer	472	<b>TUFFIER</b> , Arterienfasszangen	196
		Bauch- und Darmspatel	450
		Darm- und Gewebefasszangen	538
		Rippensperrer	866, 867
		Wundhaken	443
		Tumorfasszangen	909
		Tumorphinzetten	179
		Tunnelierungsinstrumente	853
		Tupferzangen	10, 184-190, 192, 193
		<b>TURNER</b> , Monopolare Pinzetten	517
		<b>TURNER-WARWICK</b> , Bauchdeckenhalter	492, 493
		Harnröhrenbougies	629
		<b>TUTTLE</b> , Lungenfasspinzetten	180, 838
<b>T</b>		<b>U</b>	
<b>TÄGER</b> , Knochenhebel	944	<b>UCHIDA MODIF. BURKE</b> , Ureterlöffel	691
<b>TAKAHASHI</b> , Rongeurs	901	<b>UFFENORDE</b> , Scharfe Löffel	983
Tamponhalter	582	<b>ULRICH</b> , Fistelmesser	30
Tamponzangen	672, 673	<b>ULRICH-AESCLAP</b> , Korn-, Tupfer- und Waschzangen	186
<b>TARNIER</b> , Geburtszangen	729	Ultra-Light-Pinzetten, ATRAUMATA	159, 781
<b>TAYLOR</b> , Retraktor	946	Umführungsinstrumente	925
<b>TEALE</b> , Hakenzangen	681, 682	Universaltrokare	634
Tenotome	27	Unterbindungsnadeln	329-336, 1056
<b>THOMS-GAYLOR</b> , Biopsiezangen	699	Ureter-Tunnelier-Klemmen	691
Thoraxsperrer	864, 865, 874	Ureterlöffel	691
<b>THOREK</b> , Gefäßscheren	114	Ureterzangen	624
<b>THORPE</b> , Hornhautpinzetten	151	Urethraretraktor	452, 620
Thyreoid-Spreizer	472	<b>US-ARMY</b> , Wundhaken	386
<b>TISCHLER</b> , Biopsiezangen	706	Uterus-Depressor	671
Titanligaturclip	738, 740, 742, 744	Uterus-Dilatatoren	662-664
<b>TÖNNIS</b> , Durahäkchen	360	Uterus-Dilatatoren, Lagerung	665, 666
DUROGRIP Nadelhalter	322	Uterus-Kanülen	716, 717
Feine Präparierscheren	81	Uterus-Klemmzangen	730, 731
Gefäßspatel	850		
Hohlsonden	929		
Nadelhalter	305		
<b>TÖNNIS MODIF.</b> , DUROGRIP Nadelhalter	322		
<b>TÖNNIS-ADSON</b> , DUROTIP Präparierscheren	96, 102		
Feine Präparierscheren	80		
Tonnenzangen	1070		
Tonsillen-Saugdissektoren	1103		
Tonsillenklemmen	240		
Tonsillennesser	31		
Tourniquets	851		
Trachealdilatatoren	474		





## Alphabetischer Index – Alphabetical Index

U – W

A-Z

	Seite		Seite
Uterus-Sekretlöffel	697	Waschzangen	10, 185, 186
Uterusfasszangen	688, 689	<b>WATSON</b> , Handdermatom	35
Uterusküretten	708-711	<b>WATSON-CHEYNE</b> , Raspatorien	964
Uteruslöffel	707	<b>WATSON-JONES</b> , Knochenheber	934
Uterusscheren	99, 117-120	Watteträger	347-351
Uterusscheren, DUROTIP	103	<b>WAUGH</b> , Feine chirurgische Pinzetten	172
Uterussonden	670, 671	Monopolare Pinzetten	517
Uteruspülkatheter	717	<b>WEBER</b> , Atraumatische Aorta-Anastomosenklemmen	818
		<b>WEBSTER</b> , DUROGRIP Nadelhalter	308
		Nadelhalter	299
		<b>WECKER</b> , Augenscheren	49
		<b>WEIL-BLAKESLEY</b> , Rongeurs	899
		<b>WEISSBARTH</b> , Scheidenspekula	654
		<b>WEITLANER</b> , Wundspreizer	459-461, 466
		<b>WELLER</b> , Meniskus- und Knorpelzangen	1043
		Präparierscheren	89
		<b>WERTHEIM</b> , Atraumatische Anastomosenklemmen	808
		Atraumatische Klemmzangen	272
		Atraumatische Nierenstielklemmen	612
		Atraumatische Parametriumklemmen	100, 268, 269
		DUROGRIP Nadelhalter	315
		DUROTIP Präparierscheren	99
		Gynäkologische Scheren	118
		Hysterektomieklammern	263, 264, 270
		Nierenstielklemmen	611
		Parametriumklemmen	270
		<b>WERTHEIM-CULLEN</b> , Klemmzangen	273
		Nierenstielklemmen	612
		<b>WIENER MODELL</b> , Hysterektomieklammern	262
		<b>WIKSTROEM</b> , Präparier- und Ligaturklemmen	250, 840
		<b>WILDE</b> , Pinzetten, kniegebogen	167
		<b>WILLET</b> , Kopfschwartenzange	731
		<b>WILLIAMS</b> , Lungenfasszangen	838
		Organ- und Gewebefasszangen	543
		<b>WILLIGER</b> , Elevatorien	930
		Raspatorien	961
		Scharfe Löffel	981, 984
		<b>WILSON</b> , Hakenzangen	676
		Organ- und Gewebefasszangen	199
		Tonsillenklemmen	240
		<b>WILSON-HEY</b> , Monopolare Klemme	520
		Winkelklemmen	612
		Winkelklemmen, Atraumatische-	612
		<b>WINKELMANN</b> , Beschneidungsklemmen	631
		<b>WINTER</b> , Plazentar- und Abortuszangen	732
		Wirbelkörperspreizer	481
		Wirbelsäulen-Wundspreizer	476-480
		Wirbelsäulenmeißel	1009
		<b>WITT</b> , Sternum-Punktionskanülen	855
		<b>WÖRRLEIN</b> , Repositionsstößel	1015
		<b>WOLFF</b> , Gipsabreißzangen	1087
		<b>WRIGLEY</b> , Geburtszangen	728
		<b>WULLSTEIN</b> , Saugkanülen	1098-1100
		Wundspreizer	460

### V

Vakuum Extraktion, Saugglocken	725
Vakuumküretten	714, 1090
<b>VALLEIX</b> , Uterussonden	671
Valven, Bauchdecken-	482-484
<b>VANNAS</b> , Mikro-Federscheren	48, 50, 52
<b>VARADY</b> , Mini-Venenstripper-Bestecke	888
Phlebextraktoren	889
Phlebdissektoren	889
VARIO, Wundhaken-System	420, 421
Vena-Cava-Klemmen, Atraumatische-	800
Venenhaken	373-376
Venenkomplekklammern	619
Venenscheren, Mikro-	51
Venenstripper	887, 888
Verbandscheren	131-133, 1082
<b>VERBRUGGE</b> , Knochenhalte-zangen	1023
<b>VERBRUGGE-MÜLLER</b> , Knochenheber	938
<b>VERHOEVEN</b> , Saugkanülen	1099
<b>WISE</b> , Mikro-Knüpfpinzetten	139
<b>VOLKMANN</b> , Knochen- und Wundhaken	387, 388
Scharfe Löffel	981, 984
Wundhaken	389
Vorhautfasszangen	625
Vulva-Spreizer	472, 473, 659

### W

<b>WAGENER</b> , Nerv- und Gefäßhäkchen	356
<b>WAGNER</b> , Biegeinstrumente für Kirschnerdrähte	1059
Hämmer	994
Hohlmeißel	1011
Knochenheber	936
Raspatorien	977
Rongeurs	911
<b>WALLICH</b> , Plazentar- und Abortuslöffel	712
<b>WALTER</b> , Hohlmeißel	1003
<b>WALTON</b> , Biopsiezangen für Rektum	581
<b>WANGENSTEIN</b> , DUROGRIP Nadelhalter	316
DUROGRIP Pinzetten	163, 543
Nadelhalter	303
<b>WARD</b> , Raspatorien	961

## Alphabetischer Index – Alphabetical Index

W – Z

A – Z

	Seite		Seite
Wundhäkchen	364	Zangen, Gallenblasen-	190, 594-596, 687
Wundhaken	370-411, 413-419, 422, 423, 425-435, 437-439, 442-446, 569, 946, 1045	Gallenstein-	603-605
Wundhaken, CARBOTRAC	412	Geburts-	726-729
Treangle-Griff	367-369	Gewebefass-	190, 193, 196, 197, 199, 538-540, 543
Wundhakenblätter, VARIO	420	Hämorrhoiden-	585
Wundklammern	352	Haken-	674-684
Wundrandpinzetten	170	Hohlmeißel-	860, 1026-1037
Wundrandscheren	72	Kathetereinführungs-	15
Wundspreizer	456-467, 472, 477	Klammeranlege-	352
Wundspreizer, Blasen-	496, 617	Klammerentfernungs-	352
Femur-	473	Knochenhalte-	1016-1024
Wirbelsäule	476, 477	Knochenhalte-, selbstzentrierend	1023
Wirbelsäulen-	478-480	Knochensplitter-	859, 1038-1042
		Knöchelfass-	1016
		Knorpel-	1043
		Kopfschwarten-	731
		Korn-	10, 184-189
		Kreuzbanddurchzieh-	195
		Lungenfass-	838, 839
		Meniskus-	1043
		Nagel-	12
		Nagelausreiß-	1079
		Nagelspalt-	1079
		Nierenfass-	613
		Nierenstein-	614-616
		Organfass-	190, 192, 193, 197-199, 540, 543
		Ovarien-	685-688
		Patella-	1016
		Plazentar-	732-735
		Polypen-	686-688
		Rektumbiopsie-	580-582
		Repositions-	1014-1016
		Rippenfass-	859
		Schließ-	559
		Schwamm-	190, 192, 193
		Sehnendurchzieh-	195
		Sehnensass-	194
		Sehnensführungs-	195
		Sequester-	1017
		Siebbein-	899-901
		Splitter-	181
		Sterilisier-	1109
		Synovektomie-	1026
		Tampon-	672, 673
		Tonnen-	1070
		Tumorfass-	909
		Tupfer-	10, 184-190, 192, 193
		Ureter-	624
		Uterusfass-	688, 689
		Vorhautfass-	625
		Wasch-	10, 185, 186
		Zungen-	16
		<b>ZAUFAL-JANSEN</b> , Hohlmeißelzangen	1032
		Zeichenfedern	25
<b>Y</b>			
<b>YANKAUER</b> , Saugkanülen	885, 1093, 1094		
<b>YASARGIL</b> , Mikro-Federscheren	52		
Rongeurs	908		
Saug- und Spülkanülen	1104		
<b>YEOMAN</b> , Biopsiezangen für Rektum	580		
<b>YOUNG</b> , Zungenzangen	16		
<b>YOUNG-HRYNTSCHAK</b> , Bumerang Nadelhalter	326, 623		
<b>Z</b>			
Zahnfleissscheren	12, 64-67, 69, 70		
Zahnfleissscheren, DUROTIP	92		
Zangen, Abfall-	19		
Abortus-	732-735		
Anlege-, Bulldogklemmen	786		
Arterienfass-	196		
Atraumatische Darmfass-	544, 545, 568		
Atraumatische Gallenblasen-	595		
Atraumatische Gewebefass-	544, 545, 835-837		
Atraumatische Kapselfass-	622		
Atraumatische Organfass-	191, 544, 545, 835-837		
Atraumatische Ovarien-	687		
Atraumatische Polypen-	687		
Biopsie-	699-704, 706		
Clipanlege-	738-745		
Darmfass-	538, 539, 541, 542		
Drahtbiege-	1069, 1071, 1073		
Drahtfass-	1067, 1070, 1071		
Drahtschneide-	1068, 1072-1078		
Drahtspann-	312, 1065, 1067, 1068		
Embolusfass-	846		
Extraktions- für Bohrdrähte	1070, 1071		
Fadenhalte-	326, 622		
Flach-	1069, 1070		
Fremdkörper-	200, 626		



	Seite
<b>ZENKER</b> , Präparier- und Ligaturklemmen	254
Wundhaken	427
<b>ZIEGLER</b> , Stirnbänder	2
Stirnspiegel	2
<b>ZIELKE</b> , Hohlmeißel für Skoliose-Operationen	1008
Zirkel, Becken-	720
<b>ZOELLNER</b> , Saugkanülen	1098, 1099
Zubehör, Stirnlampen	3
Zungenspatel	4, 348
Zungenzangen	16
<b>ZWEIFEL</b> , DUROGRIP Nadelhalter	323
Zwillingsklemmen, Darm-	556
Magen-	556
Zwischenknochenmesser	918

Seite

A - Z

# Alphabetischer Index – Alphabetical Index

A

A-Z

	Page		Page
<b>A</b>		<b>ALLIS-THOMAS</b> , organ- and tissue grasping forceps	540
<b>ABBEY</b> , sub-mucosal resection needles	515	<b>ALLISON</b> , lung spatula	424, 881
Abdominal retractors	437-439, 441-448, 482, 483, 485-495	<b>ALLPORT</b> , self-retaining retractors	458
Abdominal retractors, fixation device	448	<b>ALM</b> , self-retaining retractors	457
mounting frame	449	Amniotome	722
Abdominal scissors	122	Amputation knives	28, 29, 917, 918
Abdominal spatula	435, 436, 451	Amputation retractors	920
<b>ABEL</b> , uterine tenaculum forceps	677	Amputation saws	921-923
<b>ABRAHAM</b> , tonsil knives	31	Anastomosis clamps	559, 843
<b>ADAIR</b> , uterine tenaculum forceps	674	Anastomosis clamps, ATRAUMATA	560, 791-793, 799, 808, 822, 823, 825, 828-831
Adapter, bipolar	522, 533	Anastomosis forceps, ATRAUMATA	563
Adapters, suction	1099	ATRAUMATA rectal	566
<b>ADLERKREUTZ</b> , vascular and tumor forceps	179	ATRAUMATA sigmoid	564
<b>ADSON</b> , bone rongeurs	1031	sigmoid	561, 562
burrs	1052	Anatomy scissors	68
delicate dissecting forceps	151, 152	<b>ANDERSON-ADSON</b> , self-retaining laminectomy retractors	468
delicate tissue forceps	168, 169	Angle clamps	612
dissecting forceps, bayonet-shaped	165	Angle clamps, ATRAUMATA	612
DUROGRIP non-traumatic dissecting forceps	162	<b>ANGLE</b> , wire cutters	1072
hemostatic forceps	225, 226	Anusscopes	572
monopolar diathermy forceps	517	Aorta clamps, ATRAUMATA	811, 816, 817, 832
needle holders	301	Aorta punches	852
nerve and vessel hooks	358	Aorta valve retractors	884
raspatories	968	Aorta-anastomosis clamps, ATRAUMATA	818, 819
self-retaining laminectomy retractors	468, 471	Aorta-aneurysm-clamps, ATRAUMATA	813-815
suction cannula	1094, 1095	Appendectomy clamps	557
tissue forceps	170	Applicators, cotton	347-351
<b>ADSON-BABY</b> , self-retaining retractors	463	Appliers, clip	738-745
<b>ADSON-BROWN</b> , tissue forceps	170	Applying forceps, bulldog clamps	216, 786
<b>AESCLAP</b> , biopsy forceps for rectum	581	Approximators	211, 212
DUROGRIP needle holders	323	Approximators, nerve	212
hand drills	1054	Arteriotomy scissors	80
placenta and ovum forceps	734	Artery grasping forceps	196
sponge- and dressing forceps	10, 186	<b>ASCH</b> , secretions scoops	626
swab holders	582	uterine secretion scoops	697
traction bows	1061	<b>ASSMUS</b> , nerve stripper	1046
<b>AESCLAP-PRATT</b> , organ- and tissue grasping forceps	198	ATRAUMATA coarctations clamps	827
uterine tenaculum forceps	680	ATRAUMATA, anastomosis clamps	560, 791-793, 799, 808, 822, 823, 825, 828-831
<b>ALEXANDER</b> , bone rongeurs	1029	aorta anastomosis clamps	818, 819
gouges	1001	aorta aneurysm clamps	813-815
raspatories	974	aorta clamps	811, 816, 817, 832
rib raspatories	863	bronchus clamps	812
<b>ALLEN</b> , intestinal clamps	547	bulldog clamps	218, 219, 788-790, 820, 821
osteophyte chisels and scraper	962	coarctation clamps	804, 826
<b>ALLENBERG</b> , ATRAUMATA vascular clamps	803	compression forceps	272
instruments for pulling through vascular grafts	854	dissecting forceps	160, 161, 546, 567, 782, 783, 797, 798
self-retaining retractor	461, 475	gall bladder forceps	595
<b>ALLIS</b> , artery grasping forceps	196	hemorrhoidal forceps	584
ATRAUMATA intestinal grasping forceps	544, 568	hemostatic forceps	794, 795
ATRAUMATA organ- and tissue grasping forceps	836	hysterectomy forceps and vaginal clamps	267
intestinal and tissue grasping forceps	196, 539	iliac clamps	807
lung grasping forceps	839		
<b>ALLIS-ADAIR</b> , tissue and intestinal forceps	538		



# Alphabetischer Index – Alphabetical Index

A – B

A - Z

	Page		Page
ATRAUMATA, intestinal clamps	547, 548, 550, 552, 555	<b>BABY-METZENBAUM</b> NOIR dissecting scissors, Wavecut	106
intestinal grasping forceps	544, 545, 568	SuperCut scissors	91
kidney clamps	608, 796	<b>BABY-MIKULICZ</b> peritoneum forceps	257
kidney pedicle clamps	612	<b>BABY-MIXTER</b> dissecting and ligature forceps	244
ligature forceps	797, 798	<b>BABY-MOSQUITO (HARTMANN)</b> , hemostatic forceps	220
lobe grasping forceps	622	<b>BABY-OVERHOLT</b> , dissecting and ligature forceps	244
multi-purpose clamps	791-793, 809, 810, 824, 825, 828, 833, 834	<b>BABY-ROUX</b> retractors	379
organ grasping forceps	191, 544, 545, 835-837	<b>BABY-SATINSKY</b> , anastomosis clamps	843
ovum forceps	687	<b>BABY-SENN-MILLER</b> retractors	377
pankreas clamps	796	<b>BACKHAUS</b> , towel clamps	203
parametrium clamps	268	<b>BACKHAUS-KOCHER</b> towel clamps	203
patent ductus clamps	805, 806, 826, 827	<b>BAILEY</b> , rib contractors	877
pediatric vascular clamps	821	<b>BAINBRIDGE</b> , intestinal clamps	547
peripheral vascular clamps	805-807	<b>BAKES</b> , common bile duct dilators	601
polypus forceps	687	<b>BALFOUR</b> , Abdominal Retractors	488
pressure clamps	560, 612	<b>BALFOUR-BABY</b> , abdominal retractors	485
profunda clamps	798	Ball electrodes	510, 511, 514
rectal anastomosis forceps	566	Bandage scissors	131-133, 1082
sigmoid anastomosis forceps	563, 564	Bandages, compression	916
stomach clamps	557	<b>BANE-HARTMANN</b> bone rongeurs	1028
tangential occlusion clamps	801, 802	<b>BARNES-NEVILLE</b> obstetrical forceps	729
tissue grasping forceps	191, 544, 545, 835-837	<b>BARRAQUER</b> lid retractors	458
ultra-light-forceps	159, 546, 781	micro needle holders	283, 771
ureter forceps	624	<b>BARRÉ</b> , dissecting forceps	252, 619
vascular clamps	803	dissecting scissors	618
vascular clips	214, 215, 784, 785	prostate retractor	452, 620
vena cava clamps	800	suture holding frame	621
Atrium retractors	882, 883	urethral retractor	620
<b>AUFRICHT</b> , bone rasps	978	urethral retractor	452
<b>AUSTIN</b> , micro suture tying forceps	140	<b>BARRON</b> , hemorrhoidal ligators	586
<b>AUVARD</b> , vaginal specula	656	scalpel handle	38
Awls	1055, 1056	suction cannula	1097
		<b>BARSKY</b> , fine retractors	363
		<b>BARTH</b> , bone curettes	981
		<b>BAUMGARTNER</b> DUROGRIP needle holders	308
		DUROGRIP wire twisters	312, 1067
		needle holders	299
		Bayonet-shaped dissecting forceps	165, 166
<b>B</b>		<b>BEACHAM</b> , amniotome	722
<b>BABCOCK</b> ATRAUMATA intestinal grasping forceps	544	<b>BECK</b> , rongeurs	902
ATRAUMATA organ, tissue and intestinal grasping forceps	545	<b>BECKMANN-ADSON</b> self-retaining laminectomy retractors	470
ATRAUMATA organ- and tissue grasping forceps	835	<b>BECKMANN-EATON</b> self-retaining laminectomy retractors	471
lung grasping forceps	839	<b>BEEBE</b> , wire cutting scissors	129
organ- and tissue grasping forceps	540	<b>BEHRMAN</b> , uterine cannula	717
<b>BABY-ADSON</b> , dissecting and ligature forceps	245	<b>BELLUCCI</b> , suction cannula	1098
<b>BABY-ALLIS</b> , intestinal and tissue grasping forceps	538	Bending irons	1059
<b>BABY-COLLIN</b> , abdominal retractors	482	Bending pliers	1071
<b>BABY-CRILE (KOCHER)</b> , hemostatic forceps	222	<b>BENGOLEA</b> , hemostatic forceps	228
<b>BABY-CRILE (PEAN)</b> , hemostatic forceps	222	<b>BENNETT</b> , bone levers	945
<b>BABY-CRILE-WOOD</b> DUROGRIP needle holders	309	<b>BENSAUDE</b> , anoscopes	572
<b>BABY-KOCHER</b> ATRAUMATA intestinal clamps	547	<b>BENSON</b> , pylorus spreaders	557
intestinal clamps	547	<b>BERGER</b> , biopsy forceps	703
<b>BABY-METZENBAUM</b> dissecting scissors	87	<b>BERGMANN</b> , mallets	995
DUROTIP dissecting scissors	96	plaster scissors	135, 1083
DUROTIP dissecting scissors, Wavecut	102		
NOIR delicate dissecting scissors	105		

## Alphabetischer Index – Alphabetical Index

### B

	Page		Page
<b>BERGMANN</b> , scalpels	26	Bone Rongeurs	1030
wound and tracheal retractors	364	Bone shears	116
<b>BERKELEY-BONNEY</b> , hysterectomy forceps	266	<b>BONNER MODELL</b> , micro suture tying forceps	139
<b>BERNHARD</b> , towel clamps	203	<b>BONNEY</b> , dissecting forceps	158
uterine tenaculum forceps	674	polypus- and ovum forceps	688
<b>BERRY</b> , DUROGRIP wire twisters	312, 1068	tissue forceps	177
<b>BETHUNE</b> , rib shears	857	Boomerang needle holders	326, 623
<b>BEYER</b> , bone rongeurs	1029, 1032	Boring wires	1058, 1059
<b>BIEMER</b> , approximator for nerves	212	<b>BOROWSKI</b> , aorta valve retractors	884
approximators	211	<b>BORST</b> , fixation clamps	842
clip applying forceps	210, 211	<b>BOSE</b> , self-retaining retractors	456
micro vein scissors	51	wound and tracheal hooks	364
vessel clips	210	Bougies, metal	600
<b>BIEMER-MÜLLER</b> , approximators	211	urethral	629, 630
<b>BIER</b> , amputation saws	922	Bowel scissors	125, 567
Biopsy curettes, endometrial	698	Bowls, round	1108
Biopsy forceps	699-704, 706	<b>BOWMAN</b> , probes	347
Biopsy forceps, attachments	581, 704, 705	Bows, traction	1060-1062
rectum	580-582	<b>BOYS-ALLIS</b> , artery grasping forceps	196
Bipolar adapter	522, 533	intestinal and tissue grasping forceps	196, 538
Bipolar clamps	531	<b>BOZEMANN</b> , uterine dressing forceps	672, 673, 675
Bipolar coagulation forceps	523-529	uterine scissors	119
Bipolar connecting cables	532-534	vaginal specula	658
Bipolar dissecting scissors	530	<b>BOZEMANN-DOUGLAS</b> , uterine dressing forceps	673, 675
Bipolar forceps	620	<b>BRAITHWAITE</b> , skin grafting knives	35
<b>BIRCHER</b> , meniscus- and cartilage forceps	1043	<b>BRAND</b> , tendon holding forceps	195
<b>BIRCHER-GANSKE</b> , meniscus- and cartilage forceps	1043	<b>BRAUN</b> , organ- and tissue grasping forceps	197
<b>BIRKETT</b> , hemostatic forceps	228	uterine depressor	671
<b>BISHOP-HARMON</b> , delicate tissue forceps	168	uterine tenaculum forceps	678
Bladder neck spreaders	622	vaginal specula	648
Bladder retractors	496, 617	<b>BRAUN-STADLER</b> , episiotomy scissors	124, 724
Bladder spatula	496, 617	sternum shears	856
Blades, microsurgical	45	Breakers, plaster	1087
scalpel	42, 43	<b>BREISKY</b> , vaginal specula	653
<b>BLAKE</b> , embolus grasping forceps	846	<b>BRIDGE</b> , hemostatic forceps	230
gall stone forceps	603	<b>BRISTOW</b> , bone levers	933
uterine curettes	711	<b>BRODIE</b> , directors	342
Blood scoops	453	rectal probes	579
<b>BLOUNT</b> , knee retractors	400, 1045	<b>BROM</b> , vein hooks	357
<b>BLUMENTHAL</b> , bone rongeurs	1028	Bronchus clamps, ATRAUMATA	812
Bone biopsy trephines	1057	Bronchus forceps	845
Bone clamps	1025	<b>BROPHY</b> , delicate dissecting forceps	155
Bone curettes	981-989	tissue forceps	173
Bone cutting forceps	859, 1038-1042	<b>BROWN</b> , tissue forceps	170
Bone drills	1055	<b>BRUNELL</b> , hand drills	1054
Bone files	978-980	<b>BRUNNER</b> , guiding probes	336
Bone holding forceps	1016-1024	ligature needles	336, 1056
Bone holding forceps, self-centering	1023	retractors	418, 419
Bone levers	932-945, 947-959	rib shears	858
Bone punches	892-898	sigmoid anastomosis forceps	561
Bone rasps	978-980	<b>BRUNS</b> , bone curettes	984, 987
Bone rasps, DUROGRIP	979	plaster scissors	135, 1084
Bone retractors	387, 388	<b>BRYANT</b> , sponge- and dressing forceps	184
		<b>BRÜNINGS</b> , extension cannula	705



# Alphabetischer Index – Alphabetical Index

B – C

A - Z

	Page		Page
<b>BRÜNNINGS</b> , tongue spatula	4	<b>CASPAR</b> , rongeurs	904-906, 910
<b>BUCHWALD</b> , tongue spatula	4	scalpel handles	44
<b>BUCK</b> , cotton applicators	349	self-retaining retractors for spine	478, 479
<b>BUCK-GRAMCKO</b> , bone levers	932	tampers	997
Bulldog clamps	216, 217, 786, 787	<b>CASTANEDA</b> , ATRAUMATA anastomosis- and multi-purpose-clamps	791
Bulldog clamps, ATRAUMATA	218, 219, 788-790, 820, 821	<b>CASTROVIEJO</b> , delicate tissue forceps	168
Bulldog scissors	76	DUROGRIP needle holders	286, 287, 773, 774
<b>BUMM</b> , placenta- and ovum curettes	713	eye scissors	49
uterine curettes	710	micro needle holders	282, 770
<b>BUNNEL</b> , tendon passing probes	1048	micro scissors	48
tendon strippers	1047	Catheters introducing forceps	15
<b>BUNT</b> , safty pins	207	Catheters, urinary	627
<b>BURKE</b> , parametrium clamps	271, 692, 693	uterine irrigation	717
Burrs, trepanation	1052, 1053	<b>CATLIN</b> , amputation knives	28, 917
<b>BUSHE</b> , bone curettes	986	<b>CAWTHORNE</b> , cotton applicators	347
<b>BÜCHS</b> , cheek retractors	407	Cerclage wires	1065
raspatories	972	<b>CHADWICK</b> , delicate scissors	67
<b>BÖHLER</b> , bone cutting forceps	1040	<b>CHAMPIONNIÈRE</b> , bone drills	1055
bone rongeurs	1032	<b>CHAPUT</b> , artery grasping forceps	196
traction bows	1062	intestinal and tissue grasping forceps	196, 538
		<b>CHARNLEY</b> , tissue forceps	178
<b>C</b>		<b>CHARRIÈRE</b> , amputation saws	921, 922
Cables for elektrode handles	506, 513	<b>CHEATLE</b> , sterilizing forceps	1109
Cables, bipolar	532-534	Cheek retractors	405-407
monopolar	522	<b>CHERON</b> , sponge- and dressing forceps	189
<b>CAIRNS</b> , bone flap elevators	930	Chisels	998-1003, 1006-1008, 1010
dura retractors	360	Chisels, osteophyte	962, 998
hemostatic forceps	223	sternum	856
<b>CAIRNS-DOTT</b> , delicate dissecting forceps	154	Cholecystectomy forceps	592
Calculators, gestation	720	Chucks, drilling	1064
Calipers	8	Circumcision clamps	631
Cannula, coagulation	521, 1105	<b>CITELLI</b> , punches	892
hemorrhoidal	587	<b>CITELLI-BEYER</b> , punches	892
irrigation	598, 886, 1104	Clamps, anastomosis	559, 843
suction	885, 886, 1091-1102, 1104, 1105	appendectomy	557
uterine	716, 717	ATRAUMATA anastomosis	560, 791-793, 799, 808, 822, 823, 825, 828-831
vessel irrigation	846	ATRAUMATA aorta	811, 816, 817, 832
<b>CANNY-RYALL</b> , retractors	386	ATRAUMATA aorta aneurysm	813-815
<b>CARBOTRAC</b> retractor	412	ATRAUMATA aorta-anastomosis	818, 819
Cardiovascular scissors	108-111, 114	ATRAUMATA bronchus	812
Carotid shunt clamps	842	ATRAUMATA bulldog	218, 219, 788-790, 820, 821
<b>CARREL</b> , hemostatic forceps	220	ATRAUMATA coarctation	804, 826, 827
Cartilage forceps	1043	ATRAUMATA compression forceps	612
Cartilage knives	918	ATRAUMATA iliac	807
Cartilage scissors	81, 89	ATRAUMATA intestinal	547, 548, 550, 552, 555
Cartilage slitting knives	32	ATRAUMATA kidney	608, 796
Cases, needle	279	ATRAUMATA kidney pedicle	612
<b>CASPAR</b> , bone curettes	988, 989	ATRAUMATA multi-purpose	791-793, 809, 810, 824, 825, 828, 833, 834
knot tier	339	ATRAUMATA pankreas	796
nerve and vessel hooks	359	ATRAUMATA parametrium	268, 269
raspatories	969	ATRAUMATA patent ductus	805, 806, 826, 827
retractors	408		

# Alphabetischer Index – Alphabetical Index

## C

	Page		Page
Clamps, ATRAUMATA pediatric	821	<b>COLLIN</b> , ATRAUMATA organ- and tissue grasping forceps	191, 837
ATRAUMATA peripheral	805-807	clip removing forceps	352
ATRAUMATA pressure	272, 560	dressing and sponge holding forceps	192
ATRAUMATA stomach	557	hemostatic forceps	241
ATRAUMATA tangential occlusion	801, 802	intestinal grasping forceps	541
ATRAUMATA vaginal	267	kidney elevating forceps	613
ATRAUMATA vascular	803	organ- and tissue grasping forceps	192
ATRAUMATA vena cava	800	retractors	380
bipolar	531	sponge- and dressing forceps	189, 192
bone	1025	tongue forceps	16
bulldog	216, 217, 786, 787	umbilical cord clamps	724
carotid shunt	842	uterine curettes	711
circumcision	631	uterine elevating forceps	688, 689
colectomy	554	vaginal specula	636
fixation	842	<b>COLLIN-HARTMANN</b> retractors	378
gastro intestinal	556	Common bile duct dilators	601
intestinal	547-551, 553-556, 558	Compression apparatus	916
kidney	608-610	Compression bandages	916
kidney pedicle	611, 612	Compression forceps	273
parametrium	270, 271, 692, 693	Compression forceps, ATRAUMATA	272
penis	625	Conductors	925
pressure	273, 584, 612	Cone Knives	696
pylorus	558	<b>CONE</b> , hemi-laminectomy retractors	469
spermatic cord fixation	625	Contractors, rib	877
towel	201-206	<b>CONVERSE</b> , DUROGRIP needle holders	307
tubing	17, 18	fine retractors	363
twin	556	needle holders	299
umbilical cord	724	<b>COOLEY</b> , ATRAUMATA anastomosis	792, 793, 825, 828
ureteral tunnel	254, 691	and multi-purpose clamps	
vascular	844	ATRAUMATA anastomosis clamps	822, 823, 829, 831
venous plexus	619	ATRAUMATA aorta clamps	832
<b>CLAR</b> , head lights	3	ATRAUMATA bulldog clamps	820, 821
<b>CLAUS VAN EICKEN</b> , ligature needles	333	ATRAUMATA coarctation clamps	826, 827
Clip applicator	738-745	ATRAUMATA dissecting forceps	161, 783
Clip applying forceps	210, 211, 352	ATRAUMATA multi-purpose clamps	824, 833
Clip removing forceps	352	ATRAUMATA patent-ductus clamps	826, 827
Clip, titanium ligature	738, 740, 742, 744	atrium retractors	882
Clips, ATRAUMATA vascular	214, 215, 784, 785	cardiovascular scissors	114
suture	352	sternum retractors	873
vessel	210, 213	<b>COOLEY MODIF. STRUCK</b> , atrium retractors	883
Cloth scissors	132-135, 1082	<b>COOLEY-BECK</b> , ATRAUMATA anastomosis clamps	822
<b>CLOWARD</b> , lamina spreaders	481	<b>COOPER</b> , ligature needles	334
<b>CLOWARD MODIF.</b> , self-retaining retractors for spine	480	surgical scissors	73
Coagulation cannula	521, 1105	Corneal forceps	151
Coagulation forceps, bipolar	523-527	Coronary scissors	59
Coarctation clamps, ATRAUMATA	804	<b>CORYLLOS</b> , retractors	425
Coarctations clamps, ATRAUMATA	826	<b>COTTLE</b> , bulldog scissors	76
<b>COBB</b> , raspatories	974	fine wound retractors	361
<b>COBBETT</b> , skin grafting knives	35	fishtail osteotomes	1001
Colectomy clamps	554	fixation forceps	165
<b>COLLER</b> , hemostatic Forceps	224	mallets	992
<b>COLLEY</b> , delicate dissecting forceps	155, 783	osteotomes	1001
<b>COLLIN</b> , abdominal retractors	482	raspatories	965, 969
ATRAUMATA intestinal grasping forceps	544	wound and vein retractors	373





# Alphabetischer Index – Alphabetical Index

C - D

A - Z

	Page		Page
<b>COTTLE-KNAPP</b> , dissecting scissors	77	<b>DE BAKEY</b> , ATRAUMATA coarctation clamps	804
<b>COTTLE-MASING</b> , dissecting scissors	77	ATRAUMATA dissecting and ligature forceps	798
Cotton applicators	347-351	ATRAUMATA dissecting forceps	160, 161, 546, 567, 782, 783
<b>CRAFOORD</b> , hemostatic forceps	229	ATRAUMATA iliac clamps	807
vascular clamps	844	ATRAUMATA multi-purpose clamps	809, 810
<b>CRAFOORD MODIF.</b> , hemostatic forceps	230	ATRAUMATA patent-ductus clamps	805, 806
<b>CRAFOORD-SELLORS</b> , vascular clamps	844	ATRAUMATA peripheral vascular clamps	805-807
<b>CRILE</b> , hemostatic forceps	222, 224	ATRAUMATA tangential occlusion clamps	801
needle holders	305	cardiovascular scissors	110
nerve and vessel hooks	357	dissecting scissors	80
retractors	379	DUROGRIP needle holders	313, 314, 776, 777
<b>CRILE-MURRAY</b> , needle holders	300	DUROTIP gall duct scissors	597
<b>CRILE-WOOD</b> , DUROGRIP needle holders	309	DUROTIP vascular scissors	100
needle holders	300	femur retractors	473
Curettes vacuum	714, 1090	offset scissors	111
Curettes, bone	981-989	rib spreaders	870, 871
endometrial biopsy	698	suction cannula	885, 1094
ovum	713	vascular dilators	847
placenta	713	<b>DE BAKEY (LAMBERT MODIF.)</b> , ATRAUMATA	819
uterine	708-711	aorta anastomosis clamps	
<b>CUSCO</b> , vaginal specula	637, 638	<b>DE BAKEY (MORRIS MODIF.)</b> , ATRAUMATA aorta clamps	811
<b>CUSHING</b> , burrs	1052	ATRAUMATA sigmoid anastomosis forceps	563
delicate dissecting forceps	155	<b>DE BAKEY-BAINBRIDGE</b> , ATRAUMATA hemostatic forceps	794
DUROGRIP dissecting forceps	164	<b>DE BAKEY-BECK</b> , ATRAUMATA vena cava clamps	800
nerve and vessel hooks	357, 359	<b>DE BAKEY-HARKEN</b> , ATRAUMATA vena cava clamps	800
rongeurs	902, 903, 906	<b>DE BAKEY-HESS</b> , bulldog clamps	217, 787
tissue forceps	173	<b>DE BAKEY-MC QUIGG-MIXTER</b> , ATRAUMATA	797
wound and vein retractors	375, 376	dissecting and ligature forceps	
<b>CUSHING-KOCHER</b> , wound and vein retractors	374	<b>DE BAKEY-MIXTER</b> , ATRAUMATA	797
Cutters heads, Elektra II	9	dissecting and ligature forceps	
Cutters, nail	12	<b>DE BAKEY-PEAN</b> , ATRAUMATA hemostatic forceps	795
wire	1072-1074, 1076-1078	<b>DE BAKEY-RUMEL</b> , dissecting and ligature forceps	797
Cutting electrodes	509	<b>DE BAKEY-SATINSKY</b> , ATRAUMATA	802
Cystic forceps	591, 593	tangential occlusion clamps	
<b>CZERNY</b> , gall stone forceps	604	<b>DE LEE</b> , pelvimeters	720
organ- and tissue grasping forceps	197	<b>DE MARTEL</b> , conductors	925
rectal specula	570	<b>DE MARTEL-WOLFSON</b> , anastomosis clamps	559
retractors	384	closing forceps	559
uterine tenaculum forceps	679	<b>DEAVER</b> , retractors	429-434
		surgical scissors	75
		Delicate dissecting forceps	153, 783
		Delicate dissecting scissors	62, 76, 78, 80, 81
		Delicate dissecting scissors, NOIR	105
		Delicate hemostatic forceps	220-230
		Delicate scissors	61, 63-70
<b>D</b>		<b>DEMEL</b> , wire guides	1066
<b>DANDY</b> , hemostatic forceps	221	wire tightening- and twisting forceps	1065
<b>DARTIGUES</b> , kidney elevating forceps	613	<b>DENIS-BROWNE</b> , abdominal retractors	490
uterine elevating forceps	689	intestinal dissecting forceps	543
<b>DAUBENSPECK</b> , bone curettes	985	intestinal forceps	180
<b>DAVIDSON</b> , scapula retractors	426, 880	Depressors	453
<b>DAVIS</b> , vascular spatula	850	Depressors, uterine	671
<b>DE BAKEY</b> , arteriotomy scissors	80	<b>DERF</b> , DUROGRIP needle holders	307
ATRAUMATA anastomosis- and multi-purpose clamps	792	needle holders	299
ATRAUMATA aorta aneurysm clamps	813-815		
ATRAUMATA aorta clamps	817		
ATRAUMATA bulldog clamps	218, 219, 788-790		

# Alphabetischer Index – Alphabetical Index

## D

	Page		Page
Dermal punches	33	Dissecting suction tubes	1103
Dermatomes	34, 35	Dissectors	849, 850, 928, 929
<b>DERRA</b> , ATRAUMATA anastomosis- and multi-purpose clamps	793	Dissectors, phlebo suction	889 1103
<b>DERRA-COOLEY</b> , ATRAUMATA anastomosis clamps	823	tonsil suction	1103
<b>DESCHAMPS</b> , ligature needles	329-333	Distractor	1014
<b>DESJARDINS</b> , dissecting and ligature forceps	256	<b>DITTEL</b> , metal bougies and dilating sounds	600
gall duct probes	599	urethral bougies and dilating sounds	629
gall duct- and cystic forceps	591	<b>DIXON-LOVELACE</b> , hemostatic forceps	225
gall stone forceps	605	<b>DOCKHORN</b> , retractors	408
gall stone scoops	602	Double ended probes	346
<b>DESMARRES</b> , wound and vein retractors	373	<b>DOYEN</b> , abdominal retractors	444, 446
DIADUST micro forceps	145, 147, 149, 150, 753, 755, 757, 769	ATRAUMATA intestinal clamps	548, 550
DIADUST micro needle holders	289, 291-298, 759-767, 769	directors	342
DIADUST needle holders	767	gall bladder forceps	596
Diathermy forceps, monopolar	516-519	intestinal clamps	548-550
<b>DICK</b> , ATRAUMATA anastomosis clamps	808	myoma screw	690
ATRAUMATA compression forceps	272	needle holders	299
ATRAUMATA pressure clamps	560	polypus- and ovum forceps	687
<b>DIEFFENBACH</b> , bulldog clamps	216, 786	raspatories	976
<b>DIETHRICH</b> , ATRAUMATA aorta clamps	816	rib raspatories	861
cardiovascular scissors	110	towel clamps	202
micro bulldog clamps	217, 787	vaginal specula	650, 651, 654
<b>DIETHRICH-HEGEMANN</b> , cardiovascular scissors	110	<b>DOYEN-CHILD</b> , abdominal retractors	447
Dilating sounds, gall duct	600	Draw-in forceps, vascular grafts	854
urethral	629, 630	Dressing forceps	10, 184-190, 192, 193
Dilators, common bile duct	601	Drilling chucks	1064
gall duct	600	Drills	1054, 1055
tracheal	474	Drills, trepanation	1052, 1053
umbilical	724	Ductus clamps, ATRAUMATA	805, 826, 827
uterine	662-666	<b>DUNHILL</b> , hemostatic forceps	222, 227
vascular	847, 848	<b>DUPLAY</b> , sponge- and dressing forceps	185
<b>DINGMANN</b> , bone holding forceps	1017	uterine tenaculum forceps	677
<b>DINGMANN MODIF.</b> , bone holding forceps	1017	Dura hooks	361-363
Directors	342, 579	Dura retractors	360
Directors, grooved	929	Dura scissors	112
with wire loops	343, 579	<b>DURHAM</b> , retractors	405
Disposable scalpels	22-24	DUROGRIP, bone rasps	979
Dissecting forceps	156-158, 244-256, 619, 840, 841	dissecting forceps	162-164
Dissecting forceps, angular	167	micro needle holders	774
ATRAUMATA	160-162, 546, 567, 782, 783, 797, 798	needle holders	286, 287, 307-310, 312- 325, 568, 773-779
bayonet-shaped	166	needle holders with scissors	311
delicate	151-155, 783	suture forceps	163, 178
DUROGRIP	162-164, 543	wire holding forceps	1067
Dissecting hooks	376	wire twisters	312, 1067, 1068
Dissecting scissors	76, 77, 79-89, 618	DUROTIP ligature scissors	104
Dissecting scissors, bipolar	530	DUROTIP scissors	92-100, 597
delicate	62, 63, 76, 78, 80, 81	DUROTIP uterine scissors	103
DUROTIP	94-99, 101-103	DUROTIP Wavecut scissors	101-103
micro	53	DUROTIP wire cutting scissors	100
nerve	63	<b>DUVAL</b> , intestinal dissecting forceps	543
NOIR	105-107	intestinal forceps	180
		intestinal grasping forceps	542



# Alphabetischer Index – Alphabetical Index

D - F

A - Z

	Page		Page
<b>DUVAL</b> , lung grasping forceps	839	<b>FARRELL</b> , cotton applicators	348, 350
<b>DUVAL-COLLIN</b> , intestinal grasping forceps	541	<b>FAURE</b> , biopsy forceps	700
		peritoneum forceps	260
<b>E</b>		<b>FAVOLORO</b> , cardiovascular scissors	111
Ear hooks	356	<b>FEILCHENFELD</b> , splinter forceps	181
<b>EAST GRINSTEAD (WARD)</b> , chisels	1002	Femur retractors	473
osteotomes	1002	<b>FERGUSSON</b> , bone holding forceps	1018
<b>EASTMAN</b> , chisels	1002	pressure clamps	584
vaginal specula	652	suction cannula	1095, 1096, 1102
<b>ECHLIN</b> , bone rongeurs	1033	<b>FERGUSSON-ACKLAND</b> , mouth gags	14
<b>ECKHOFF</b> , mapping pen	25	<b>FERRIS-SMITH</b> , DUROGRIP dissecting forceps	163
Electric hair clippers	9	Fibre light attachment	574, 575
Electrode handles	506-508, 513	Fibre light carrier	575
Electrode handles, single use	508	<b>FICKLING</b> , hemostatic forceps	237
Electrodes, ball	510, 511, 514	Files, bone	978-980
cutting	509	nail	13
knife	509, 511	Fine retractors	360, 363
loop	509, 514	Fine wound retractors	361, 362
needle	509-512, 514	Finger goniometer	8
plate	510	Finger ring saws	1079
wire loop	511, 512	<b>FINOCHIETTO</b> , dissecting and ligature forceps	251, 840
Elevators	930, 931, 963	DUROGRIP needle holders	318
Embolus grasping forceps	846	rib spreaders	866-868
<b>EMMET</b> , fistula hooks	372	thoracic retractors	864, 865
sponge- and dressing forceps	189	<b>FINOCHIETTO-BURFORD</b> , rib spreaders	869
Endarterectomy strippers	851	<b>FINSEN</b> , self-retaining retractors	456
Endometrial biopsy curettes	698	<b>FINSEN MODIF.</b> , self-retaining retractors	456
Endospecula for cervix and urethra	667	<b>FINSTERER</b> , suction and irrigation cannula	886, 1104
<b>ENGEL</b> , plaster saws	1082	<b>FISCH</b> , dura retractors	363
<b>ENGL. MOD.</b> , towel clamps	201	Fistail osteotomes	1001
Enucleation scissors	77	Fistula hooks	372
Episiotomy scissors	124, 724	Fistula knives	30
<b>EPPENDORF</b> , biopsy forceps	703	Fistula probes	343, 579
<b>ESMARCH</b> , compression bandage	916	Fixation clamps	842
plaster knives	1082	Fixation device, abdominal retractors	448
plaster scissors	135, 1083	Fixation forceps	165
Ethmoidal forceps	899-901	Flap knives	28, 917
Exploration hooks	359	Flat-nosed pliers	1069, 1070
Extension cannula	705	<b>FOMON</b> , bone files	979
Extraction pliers for boring wires	1070, 1071	lower lateral scissors	77
Extractors, phleb	889	rasps	979
Eye forceps	168	retractors	370
Eye scissors	49	Forceps, applying, bulldog clamps	216, 786
		artery grasping	196
<b>F</b>		ATRAUMATA compression	272
<b>FARABEUF</b> , bone holding forceps	1019	ATRAUMATA dissecting	160-162, 782, 783, 797, 798
raspatories	971	ATRAUMATA gall bladder	595
retractors	379	ATRAUMATA hemorrhoidal	584
<b>FARABEUF-COLLIN</b> , raspatories	971	ATRAUMATA hemostatic	794, 795
<b>FARABEUF-LAMBOTTE</b> , bone holding forceps	1019	ATRAUMATA hysterectomy	267
		ATRAUMATA intestinal	544, 568
		ATRAUMATA intestinal grasping	544, 545
		ATRAUMATA ligature	797, 798
		ATRAUMATA lobe grasping	622

## Alphabetischer Index – Alphabetical Index

### F

	Page		Page
Forceps, ATRAUMATA organ grasping	191, 544, 545, 835-837	Forceps, kidney elevating	613
ATRAUMATA ovum	687	kidney stone	614-616
ATRAUMATA polypus	687	ligature	158, 244-256, 840, 841
ATRAUMATA rectal anastomosis	566	ligature holding	326, 622
ATRAUMATA sigmoid anastomosis	563, 564	lung grasping	180, 838, 839
ATRAUMATA tissue grasping	191, 544, 545, 835-837	malleolar	1016
ATRAUMATA ultra-light	159, 781	membrane puncturing	722
biopsy	699-704, 706	meniscus	1043
biopsy for rectum	580-582	micro	139-143, 145, 147, 149, 753, 755, 757, 769
bone cutting	859, 1038-1042	micro, jeweler patterns	138
bone holding	1016-1024	micro, suture tying	139
bone holding, self-centering	1023	monopolar diathermy	516-518, 520
bronchus	845	nail extracting	1079
caesarean section	730, 731	nail splitting	1079
cartilage	1043	obstetrical	726-729
catheters introducing	15	organ grasping	190, 192, 193, 197-199, 540, 543, 839
cholecystectomy	592	ovum	685-688, 732-735
clip applying	210, 211, 352	patella	1016
clip removing	352	peritoneum	257-260
closing	559	pick-up	19
coagulation, bipolar	523-529	placenta	732-735
compression	273	polypus	685-688
corneal	151	reposition	1014-1016
cross ligament passing	195	rib holding	859
cystic	591, 593	scalp flap	731
delicate	783	sequestrum	1017
DIADUST	145, 147, 149, 150, 753, 755, 757, 769	sigmoid anastomosis	561, 562
dissecting	156-158, 163, 164, 244- 256, 619, 840, 841	sinus	184
dissecting, angular	167	splinter	181
dissecting, bayonet-shaped	165, 166	sponge	10, 185-190
dissecting, delicate	151-155	sponge holding	184, 192, 193
dissecting, diathermy	519	sterilizing	1109
dressing	10, 184-190, 192, 193	suture	163, 178
dressing nasal	165-167	suture tying	139, 140, 143
DUROGRIP	162, 163, 178	tendon holding	195
embolus grasping	846	tendon interlacing	194
ethmoidal	899-901	tendon passing	195
eye	168	tendon seizing	194
fixation	165	tissue	168, 170, 173-179
foreign body	200, 626	tissue grasping	190, 192, 193, 196-199, 538-540, 543
foreskin grasping	625	tissue, delicate	168, 169, 171, 172
gall bladder	594-596	tongue	16
gall duct	590-593	tonsil	240
gall stone	603-605	tumor	179
grasping for ligamentum flavum	913	tumor grasping	909
hemorrhoidal	583, 585	ureter, ATRAUMATA	624
hemostatic	231-241	uterine dressing	672, 673, 675
hemostatic, delicate	220-230	uterine elevating	688, 689
Hysterectomy	262	uterine tenaculum	674-684
intestinal	180, 543	vascular	179
intestinal dissecting	543	wire cutting	1068
intestinal grasping	538, 539, 541, 542		



## Alphabetischer Index – Alphabetical Index

F – G

A – Z

	Page		Page
Forceps, wire holding	1070, 1071	<b>GIGLI</b> , wire saws	924
wire holding, DUROGRIP	1067	<b>GILLIES</b> , delicate dissecting forceps	154
wire tightening	1065	delicate tissue forceps	172
wire twisting	1065	DUROGRIP needle holders with scissors	311
Foreign body forceps	200, 626	fine retractors	362
Foreskin grasping forceps	625	monopolar diathermy forceps	517
<b>FORMBY</b> , suction cannula	1097	needle holders with scissors	304
<b>FOWLER</b> , tonsil knives	31	osteotomes	999
Frame, suture holding	621	suction cannula	1101
<b>FRASER-KELLY (CRILE)</b> , hemostatic forceps	226	<b>GLASSER</b> , DIADUST micro needle holder	296, 766
<b>FRAZIER</b> , dura retractors	360	<b>GLOVER</b> , ATRAUMATA anastomosis clamps	799
suction cannula	1096	ATRAUMATA bulldog clamps	218, 219, 788, 789
<b>FREER</b> , chisels	998	<b>GLUCK</b> , rib shears	857
dissectors	849	<b>GOELET</b> , Retractor	386
fine retractors	361	<b>GOLDMAN-FOX</b> , DUROTIP scissors	92
gouges	998	<b>GOLIGHER</b> , abdominal retractors	488
raspatories	963-965	Goniometers	8
<b>FREER-YASARGIL</b> , raspatories	965	<b>GORNEY</b> , dissecting scissors	81
<b>FRIEDMAN</b> , bone rongeurs	1026	suction dissectors	1103
<b>FRITSCH</b> , abdominal retractors	445	SuperCut scissors	90
<b>FRYKHOLM</b> , bone rongeurs	1033	<b>GOSLEE</b> , wire bending pliers	1069
<b>FUCHSIG</b> , hemostatic forceps	225	<b>GOSSET</b> , abdominal retractors	485
<b>FÖRSTER-BALLENGER</b> , gall bladder forceps	594	Gouges	998-1001, 1003, 1007, 1008, 1010, 1011
sponge holding and dressing forceps	190	Gouges, lamina	1009
		scoliosis operations	1008
		spongiosa	1009, 1010
<b>G</b>		<b>GOULIAN</b> , skin grafting knives	34
<b>GABRIEL</b> , hemorrhoidal cannula	587	<b>GOURDET</b> , uterine scoops	707
hemorrhoidal syringes	587	<b>GRAEFE</b> , dissecting scissors	76
rectal specula	573	nerve- and vessel hooks	356
Gags, mouth	14, 15	skin hooks	360
<b>GALABINS</b> , uterine probes	670	tissue forceps	170
Gall bladder forceps	594-596	Grasping forceps for ligamentum flavum	913
Gall bladder forceps, ATRAUMATA	595	Grasping forceps, artery	196
Gall bladder scissors	596	ATRAUMATA intestinal	544, 545, 568
Gall duct dilators	600	ATRAUMATA lobe	622
Gall duct forceps	590-593	ATRAUMATA organ	191, 544, 545, 835-837
Gall duct probes	598, 599	ATRAUMATA tissue	191, 544, 545, 835-837
Gall duct scissors	597	embolus	846
Gall duct scissors, DUROTIP	597	foreskin	625
Gall stone forceps	603-605	intestinal	180, 538-543
Gall stone scoops	602	lung	838, 839
<b>GALLAHER</b> , bone files	978	organ	197-199, 540, 543
<b>GARRETT</b> , vascular dilators	848	tissue	196-199, 538-540, 543
Gastro-intestinal clamps	556	tumor	909
<b>GELPI</b> , skin retractors	473	uterine	197
vaginal retractors	473, 659	<b>GRAVE</b> , vaginal specula	640
<b>GEMINI</b> , dissecting and ligature forceps	248	<b>GRAY</b> , cholecystectomy forceps	592
<b>GERALD</b> , delicate dissecting forceps	154	dissecting and ligature forceps	256
delicate tissue forceps	172	<b>GREEN-ARMYTAGE</b> , caesarean section hemostatic forceps	730, 731
micro forceps	149, 757	<b>GREENE</b> , cheek retractors	406
Gestation calculators	720	<b>GREGORY</b> , atraumatic profunda clamps	798
<b>GIERTZ-STILLE</b> , rib shears	858	<b>GREY-TURNER</b> , hemostatic forceps	227

# Alphabetischer Index – Alphabetical Index

G - H

A - Z

	Page		Page
Grooved directors	929	Head mirrors	2
<b>GROSS</b> , sponge- and dressing forceps	10, 185	<b>HEANEY</b> , ATRAUMATA hysterectomy forceps	267
<b>GRUENWALD</b> , dissecting forceps, bayonet-shaped	166	DUROGRIP needle holders	315
DUROGRIP dissecting forceps	164	hysterectomy forceps	261
Guide needles	353	needle holders	302
Guides, wire	1066	uterine curettes	711
Guiding probes	336-338	vaginal specula	652
<b>GULEKE</b> , bone rongeurs	1030	<b>HEANEY MODIF.</b> , hysterectomy forceps	261
<b>GUTHRIE</b> , skin hooks	360	<b>HEANEY-BALLENTINE</b> , Hysterectomy Forceps	262
<b>GUYON</b> , ATRAUMATA kidney clamps	608	<b>HEANEY-REZEK</b> , Hysterectomy Forceps	261
kidney clamps	608-610	<b>HEATH</b> , clip removing forceps	352
urethral bougies and dilating sounds	630	mallets	996
<b>GWILLIAM</b> , hysterectomy forceps	266	<b>HEGAR</b> , DUROGRIP needle holders	310
Gynecology scissors	117-121	needle holders	302
		uterine dilators	662-664
		<b>HEGAR-MAYO</b> , DUROGRIP needle holders	310
		<b>HEGAR-MAYO-SEELEY</b> , DUROGRIP needle holders	309
		<b>HEGAR-OLSEN</b> , DUROGRIP needle holders with scissors	311
		needle holders with scissors	304
		<b>HEGAR-OLSEN MODIF. LANGE</b> ,	311
		DUROGRIP needle holders with scissors	
		<b>HEGENBARTH</b> , clip applying forceps	352
<b>H</b>		<b>HEIMING</b> , kidney stone forceps	614
<b>HAASE</b> , reposition forceps	1014	<b>HEISS</b> , dissecting and ligature forceps	250
<b>HABERER</b> , abdominal and intestinal spatula	450	hemostatic forceps	227
<b>HAIGHT</b> , rib spreaders	867	<b>HEISTER</b> , mouth gags	14
Hair clippers, electric	9	<b>HELLBERG/KUPKA</b> , DUROGRIP needle holders	321, 775
<b>HAJEK</b> , irrigation cannula	598	Hemi-laminectomy retractors	469
mallets	993	<b>HEMINGWAY</b> , bone curettes	982
retractors	385	Hemorrhoidal cannula	587
<b>HAJEK-KOFLER</b> punches	893, 894	Hemorrhoidal forceps	583, 585
<b>HAKANSSON</b> , bone rongeurs	1028	Hemorrhoidal forceps, ATRAUMATA	584
<b>HALLE</b> , bone curettes	985	Hemorrhoidal ligators	585, 586
dissectors	849	Hemorrhoidal syringes	587
elevators	963	Hemostatic forceps	231-241
<b>HALSEY</b> , DUROGRIP needle holders	307, 308	Hemostatic forceps, ATRAUMATA	794, 795
needle holders	299	caesarean section	730, 731
<b>HALSTED</b> , hemostatic forceps	225	delicate	220-230
<b>HALSTED-MOSQUITO</b> , hemostatic forceps	220, 226	<b>HENCKEL-TILLEY</b> , rongeurs	900
Hand drills	1052-1054	<b>HENDERSON</b> , self-retaining retractors	465
Hand fixation plate	1049	<b>HENNIG</b> , plaster spreaders	1087
Handles, electrode	506-508, 513	<b>HERFF</b> , membrane puncturing forceps	722
scalpel	38-41, 44, 45, 618	<b>HERRICK</b> , kidney pedicle clamps	611
suction	1092	<b>HERTZLER</b> , abdominal retractors	485
VARIO retractor system	421	rib spreaders	866
<b>HARRINGTON</b> , lung spatula	422, 878	<b>HERZ</b> , tendon seizing forceps	194
retractors	422	<b>HESS</b> , nerve root retractors	376
<b>HARRINGTON-PEMBERTON</b> lung spatula	879	<b>HEY GROVES</b> , bone holding forceps	1022
retractors	423	<b>HEYWOOD-SMITH</b> , gall bladder forceps	594, 595
<b>HARTMANN</b> , ATRAUMATA intestinal clamps	548	hemorrhoidal forceps	583
cotton applicator	351	organ- and tissue grasping forceps	193
intestinal clamps	548	polypus and ovum forceps	685, 686
tuning forks	6	sponge holding and dressing forceps	192, 193
<b>HARVEY</b> , wire cutting pliers	1074	tongue forceps	16
wire cutting scissors	129, 1073		
<b>HARVEY JACKSON</b> , self-retaining laminectomy retractors	470		
<b>HASSON</b> , retractors	428		
Head lights	3		
Head lights, accessories	3		



# Alphabetischer Index – Alphabetical Index

H - J

A - Z

	Page		Page
<b>HEYWOOD-SMITH MODIF.</b> , gall bladder forceps	596	<b>I</b>	
hemorrhoidal forceps	583	Iliac clamps, ATRAUMATA	807
sponge holding and dressing forceps	192	Iliaca retractor	475
<b>HIBBS</b> , osteotomes	1004	<b>ILNER</b> , fine retractors	363
retractors	946	Incisions scissors	75
<b>HILL</b> , raspatories	965	<b>INGE</b> , lamina spreaders	481
Hip retractors	947-959	Ink pot	25
<b>HOHMANN</b> , bone levers	940	Instruments oil	1112
<b>HOHMANN-ALDINGER</b> , bone levers	943	Instruments, tunneling	853
Holders, clamp	559	Interosseus knives	918
needle	299-303, 305	Intestinal clamps	547-551, 553-556, 558
needle, DUROGRIP	286, 568	Intestinal clamps, ATRAUMATA	547, 548, 550, 552, 555
needle, with scissors	304	Intestinal dissecting forceps	543
swab	582	Intestinal forceps	180, 543
Hollow mills	1057	Intestinal grasping forceps	538, 539, 541, 542
<b>HOLZBACH</b> , abdominal retractors	483	Intestinal grasping forceps, ATRAUMATA	544, 545, 568
hysterectomy forceps	265	Intestinal needles	278
Hooks, coagulation	359	Intestinal spatula	435, 436, 450, 451
dissecting	376	Irrigation cannula	598, 886, 1104
dura	361-363	Irrigation cannula, vessel	846
ear	356	<b>IRWIN</b> , self-retaining retractors	467
exploration	359	<b>ISRAEL</b> , retractors	393
fistula	372	<b>IVES-FANSLER</b> , anoscopes	572
I.U.D. removing	697		
nerve	356-359, 376	<b>J</b>	
saddle	369	<b>JACKSON</b> , tendon seizing forceps	194
skin	360-363	vaginal specula	650
spermatic cord	625	<b>JACKSON-BURROWS</b> , self-retaining retractors	472
tendon	373	tissue forceps	177
tendon double	369	<b>JACOBS</b> , uterine tenaculum forceps	682
tracheal	364	<b>JACOBSON</b> , bone curettes	981
vein	357	hemostatic forceps	221, 226
vessel	356-359	micro needle holders	282, 770
wound	364	micro scissors	52
<b>HOPT</b> , ATRAUMATA kidney and pancreas clamps	796	<b>JAMESON</b> , dissecting scissors	79
<b>HOUSE</b> , suction adapter	1099	needle holders	302
suction and irrigation cannula	1104	SuperCut scissors	90
<b>HOWARTH</b> , raspatories	964	<b>JAMESON-WERBER</b> , dissecting scissors	79
<b>HUDSON</b> , burrs	1052	<b>JANSEN</b> , bone curettes	981, 982
delicate dissecting forceps	151	bone rongeurs	1028, 1029
hand drills	1052	dissecting forceps, bayonet-shaped	165
tissue forceps	170	raspatories	972
<b>HUDSON DOWNS</b> , burrs	1053	self-retaining retractors	458
hand drills	1053	<b>JAVID</b> , Carotid shunt clamps	842
<b>HUMBY</b> , skin grafting knives	35	<b>JEFFERSON</b> , delicate dissecting forceps	152
<b>HUNTER</b> , splinter forceps	181	delicate tissue forceps	169
<b>HURD</b> , ligature needles	332	self-retaining retractors	464
Hysterectomy Forceps	262	<b>JENKNER</b> , instruments for tunneling	853
Hysterectomy forceps, ATRAUMATA	267	and pulling-through vascular grafts	
Hysterectomy scissors	120	<b>JOHNS-HOPKINS</b> , applying and removing forceps	216, 786
Hysterectomy scissors, DUROTIP	100	bulldog clamps	216, 786
<b>HÖSEL</b> , DUROGRIP needle holders	324	<b>JOLL (FRIEDMAN)</b> , thyroid- and vaginal retractors	472, 659
retractors	411, 569		

# Alphabetischer Index – Alphabetical Index

J – K

A – Z

	Page		Page
<b>JONES</b> , towel clamps	201	<b>KILNER</b> , dissecting scissors	79
<b>JONESCO</b> , ligature needles	333	DUROGRIP needle holders	308
<b>JOSEPH</b> , bone files	978	fine retractors	361
delicate scissors	61, 70	needle holders	300
nasal knives	32	retractors	377, 383
raspatories	961	<b>KING COLLEGE HOSPITAL</b> , cotton applicator	349
skin hooks and retractors	362	<b>KIRSCH</b> , retractors	405
SuperCut scissors	90	<b>KIRSCHNER</b> , abdominal retractors	494, 495
<b>JUDD-ALLIS</b> , organ- and tissue grasping forceps	540	boring wires	1058, 1059
<b>JÄGER</b> , skin hooks	362	guiding probes	338
tendon- and cross ligament passing forceps	195	traction bows	1060
		<b>KLAPP</b> , tendon hooks	373
		Kleiderscheren	1082
<b>K</b>		<b>KLEINERT-KUTZ</b> , tendon passing forceps	195
<b>KADER</b> , abdominal and intestinal spatula	451	<b>KLEINSCHMIDT</b> , appendectomy clamps	557
<b>KALLMORGEN</b> , vaginal specula	646	<b>KLIMA-ROSEGGGER</b> , sternal puncture needles	634
<b>KANTROWITZ</b> , dissecting and ligature forceps	252	<b>KLINIKUM BERLIN</b> , tubing clamps	17
<b>KAZANJIAN</b> , bone cutting forceps	1038	<b>KLINKENBERG-LOTH</b> , vascular scissors	115
<b>KELLY</b> , abdominal retractors	439	Knee retractors	399, 400, 1045
delicate scissors	70	Knife electrodes	509, 511
dressing and sponge holding forceps	193	Knives, amputation	28, 29, 917, 918
hemostatic forceps	221	cartilage	918
organ- and tissue grasping forceps	193	cartilage slitting	32
placenta and ovum forceps	734	cone	696
polypus and ovum forceps	685	fistula	30
proctoscopes	573	flap	28, 917
retractors	415	interosseus	918
sphincteroscopes	572	meniscus	1044
<b>KERN-LANE</b> , bone holding forceps	1020, 1021	nasal	32
<b>KERN-MINI</b> , bone holding forceps	1021	periosteum	29, 918
<b>KERPEL</b> , bone curettes	983	phalangeal	29, 918
<b>KERRISON</b> , punches	892, 898	plaster	1082
punches, detachable	896-898	resection	29, 918
<b>KERSTING</b> , ATRAUMATA sigmoid anastomosis forceps	564	skin grafting	34, 35
<b>KEY</b> , raspatories	972	tonsil	31
<b>KEYES</b> , dermal punches	33	trigeminal	31
<b>KEYES MODIF.</b> , dermal punches	33	Knot tier	339
Kidney clamps	608-610	<b>KNOWLES</b> , bandage scissors	131
Kidney clamps, ATRAUMATA	608, 796	<b>KOCHER</b> , ATRAUMATA intestinal clamps	552
Kidney elevating forceps	613	bone retractors	387
Kidney pedicle clamps	611, 612	depressors	453
Kidney pedicle clamps, ATRAUMATA	612	guiding probes	337
Kidney stone forceps	614-616	hemostatic forceps	235
Kidney trays	1108	intestinal clamps	549, 551
<b>KIEBACK</b> , parametrium scissors	120, 121, 692, 693	ligature needles	335
ureteral tunnel clamps	254, 691	retractors	387, 389, 390, 403, 409
<b>KIELLAND</b> , obstetrical forceps	726	wound and vein retractors	374
<b>KILLIAN</b> , bone shears	116	<b>KOCHER-LANGENBECK</b> , retractors	396
probes	347	<b>KOCHER-OCHSNER</b> , hemostatic forceps	236
raspatories	964	<b>KOCHER-WAGNER</b> , retractors	410
rectal specula	570	<b>KOFLER</b> , punches	894
<b>KILNER</b> , cheek retractors	383	<b>KOGAN</b> , endospecula	667
delicate dissecting scissors	76	endospecula for cervix and urethra	667
		<b>KRAUSE</b> , biopsy tips	705





# Alphabetischer Index – Alphabetical Index

K - L

A - Z

	Page		Page
<b>KRAYENBÜHL</b> , nerve and vessel hooks	358	<b>LANE TRETHOWAN</b> , bone levers	933
<b>KRISTELLER</b> , vaginal specula	641-645, 647	<b>LANG-STEVENSON</b> , intestinal clamps	554
<b>KRONECKER</b> , ligature needles	329	<b>LANG</b> , fistula hooks	372
Krypt hooks	579	<b>LANG</b> - <b>HOHMANN</b> , bone levers	934
<b>KRÄMER</b> , chisels for osteophytes	998	<b>LANG</b> - <b>HOHMANN MODIF.</b> , bone levers	935
grasping forceps for ligamentum flavum	913	<b>LANGENBECK</b> , amputation saws	923
raspatories	971, 972	bone holding forceps	1018
retractors	407	DUROGRIP needle holders	322
rongeurs	909	elevators	931
<b>KRÖNLEIN</b> , hemostatic forceps	231	flap knives	28, 917
<b>KÜMMEL</b> , retractors	436	raspatories	971, 972
<b>KÜSTNER</b> , uterine tenaculum forceps	681	resection knives	29, 918
<b>KÖNIG</b> , elevators	930	retractors	394, 395, 398
guiding probes	337	rib raspatories	863, 972
raspatories	960	<b>LANGENBECK-GREEN</b> , retractors	370
wound and vein retractors	374	<b>LANGENBECK-MANNERFELTMODIF.</b> ,	368
<b>KÖRTE</b> , retractors	392, 436	retractors with triangle handle	5
<b>KÖRTE-WAGNER</b> , retractors	392	Laryngeal mirrors	348, 350
		<b>LATHBURY-FARRELL</b> , cotton applicators	253
		<b>LAWRENCE</b> , dissecting and ligature forceps	301
		needle holders	140
		<b>LAZAR</b> , micro suture tying forceps	1049
		Lead hand	925
		<b>LEBSCH</b> , conductors	856
		sternum chisels	704
<b>L</b>		<b>LEECH-WILKINSON</b> , biopsy forceps	716
<b>LA GRANGE</b> , delicate scissors	69	uterine cannula	812
<b>LABORDE</b> , tracheal dilators	474	<b>LEES</b> , ATRAUMATA bronchus clamps	812
<b>LAHEY (SWEET)</b> , dissecting and ligature forceps	255	<b>LEGUEU</b> , bladder spatula	496, 617
<b>LAHEY</b> , dissecting and ligature forceps	255	<b>LEITZ</b> , ATRAUMATA anastomosis clamps	828
gall duct forceps	590	<b>LEKSELL</b> , bone rongeurs	1033
organ- and tissue grasping forceps	197	<b>LEKSELL-STILLE</b> , bone rongeurs	1034
retractors	404	<b>LELAND-JONES</b> , ATRAUMATA, peripheral vascular clamps	807
uterine tenaculum forceps	678	<b>LEMPERT</b> , bone curettes	985
<b>LAMBERT-KAY</b> , ATRAUMATA aorta anastomosis clamps	819	bone rongeurs	1029
<b>LAMBOTTE</b> , bone holding forceps	1024	raspatories	962
osteotomes	1001, 1005	<b>LERICHE</b> , hemostatic forceps	223
raspatories	973	retractors	435
rib raspatories	863	Levers, bone	932-945, 947-959
Lamina gouges	1009	luxation	945, 947
Lamina spreaders	481	obstetric	730
Laminectomy retractors, self-retaining	468, 470, 471, 476-478	<b>LEWIN</b> , bone clamps	1025
<b>LANCASTER</b> , lid retractors	458	<b>LEWIS</b> , bone rasps	978
<b>LANDAU</b> , vaginal specula	653	<b>LEXER</b> , dissecting scissors	85
<b>LANDOLT</b> , coagulation and suction cannula	521, 1105	DUROTIP dissecting scissors	95, 101
dissecting suction tubes	1103	gouges	1008
enucleation scissors	77	NOIR dissecting scissors, Wavecut	107
raspatories	969	osteotomes	1008, 1010
scalpel handles	45	spongiosa gouges	1010
tumor grasping forceps	909	<b>LEXER-MINI</b> , gouges	1007
<b>LANDON</b> , vaginal specula	651	osteotomes	1007
<b>LANE</b> , bone holding forceps	1020, 1021	<b>LICHTENBERG</b> , DUROGRIP needle holders	324
bone levers	933	Lid retractors	458
gastro-intestinal twin forceps	556	Ligators, hemorrhoidal	585, 586
organ- and tissue grasping forceps	543		
retractors	384		
tissue forceps	176		
towel clamps	202		

## Alphabetischer Index – Alphabetical Index

L – M

A – Z

	Page		Page
Ligature clip, titanium	738, 740, 742, 744	<b>LUER-STILLE</b> , bone rongeurs	1035, 1036
Ligature discs	1065	Lung grasping forceps	180, 838, 839
Ligature forceps	158, 244–256, 840, 841	Lung spatula	422–426, 878, 879, 881
Ligature forceps, ATRAUMATA	797, 798	Luxation levers	945, 947
Ligature holding forceps	326, 622		
Ligature needles	329–336, 1056		
Ligature rubber rings	585		
Ligature scissors	128		
Ligature scissors, DUROTIP	92, 101, 104		
micro	60		
<b>LISTER</b> , bandage scissors	132	<b>M</b>	
bandage- and cloth scissors	133	<b>MAC DONALD</b> , raspatories	964
sinus forceps	184	<b>MAGILL</b> , catheters introducing forceps	15
Verband- und Kleiderscheren	1082	suction cannula	1100
<b>LISTON</b> , amputation knives	28, 917	<b>MAIER</b> , sponge- and dressing forceps	187
bone cutting forceps	1039, 1041	<b>MAINGOT</b> , hysterectomy forceps	260
<b>LISTON-KEY-HORSLEY(TUDOR EDWARDS)</b> ,	859, 1042	Malleable spatulas	450
bone cutting forceps	859, 1042	Malleolar forceps	1016
<b>LISTON-STILLE</b> , bone cutting forceps	859, 1042	Mallets	992–996
<b>LITTAUER</b> , ligature scissors	128	<b>MALTZ</b> , bone rasps	978
<b>LITTLER</b> , dissecting scissors	76	Mamilla markers	8
<b>LITTLEWOOD</b> , uterine tenaculum forceps	683	Mammaria retractors	876
<b>LLOYD-DAVIES</b> , biopsy forceps for rectum	580	<b>MANNERFELT MODIF.</b> , gouges	998
proctoscopes	575	osteotomes	998
sigmoid anastomosis forceps	562	raspatories	967
sigmoidoscopes	575	retractors with triangle handle	367–369
<b>LLOYD-DAVIES (GOLIGHER'S)</b> , rectal scissors	125, 565	saddle hooks	369
Lobe grasping forceps, ATRAUMATA	622	spatula	369
<b>LOCKHART-MUMMERY</b> , fistula probes	343, 579	tendon double hooks	369
rectal probes	343	Mapping pens	25
<b>LOCKLIN</b> , delicate scissors	69	<b>MARBURG</b> , wire bending pliers	1069
<b>LOCKWOOD</b> , intestinal grasping forceps	541	Markers, mamilla	8
<b>LOGAN MODIF. REILL</b> , self-retaining retractors	457	<b>MARQUARDT</b> , bone rongeurs	1032
Loop electrodes	509, 514	<b>MARTIN</b> , meniscus- and cartilage forceps	1043
<b>LOPEZ-REINKE</b> , tonsil suction dissectors	1103	pelvimeters	720
<b>LORNA</b> , Towel clamps	205	retractors	417
<b>LOUTE</b> , wire tightener	1065	uterine probes	670
<b>LOVE-GRUENWALD</b> , rongeurs	902, 906, 907	uterine tenaculum forceps	677
Lower lateral scissors	77	vaginal specula	655
<b>LOWER</b> , dissecting and ligature forceps	255	<b>MARTINI</b> , bone curettes	981
gall duct forceps	590	<b>MASING</b> , cartilage slitting knives	32
<b>LOWMAN</b> , bone clamps	1025	DUROGRIP needle holders	307
<b>LOWMAN-GERSTER</b> , bone clamps	1025	wound and vein retractors	373
<b>LOWMAN-HOGLUND</b> , bone clamps	1025	<b>MASSON</b> , DUROGRIP needle holders	318
<b>LUCAE</b> , dissecting forceps, bayonet-shaped	165	needle holders	303
tuning fork	6	<b>MASSON-LUETHY</b> , needle holders	303
<b>LUCAS</b> , bone curettes	982	<b>MATHIEU</b> , DUROGRIP needle holders	325
chisels	1001	foreign body forceps	626
gouges	1001	needle holders	305
<b>LUER</b> , bone rongeurs	1027, 1028, 1030	rectal specula	571
hemorrhoidal forceps	583	retractors	385
retractors	379	vaginal specula	649
<b>LUER-FRIEDMANN</b> , bone rongeurs	1026	<b>MATHIEU-STILLE</b> , needle holders	305
<b>LUER-KÖRTE MODIF.</b> , gall stone scoops	602	<b>MAYFIELD</b> , bone rongeurs	1032
		<b>MAYO</b> , dissecting scissors	82, 83, 86
		DUROTIP dissecting scissors	94, 101
		gall duct probes	598



# Alphabetischer Index – Alphabetical Index

M

A - Z

	Page		Page
<b>MAYO</b> , safty pins	207	Micro ligature scissors	60
SuperCut scissors	91	Micro needle holders	282-285, 770-772
uterine probes	670	Micro needle holders, DIADUST	289, 291, 293, 295-298, 759, 761, 763, 765-767, 769
<b>MAYO-ADAMS</b> , self-retaining retractors	465	DUROGRIP	287, 774
<b>MAYO-HARRINGTON</b> , dissecting scissors	84	Micro scalpel handles	44, 45
<b>MAYO-HEGAR</b> , needle holders	301, 302	Micro scalpels	24
<b>MAYO-LEXER</b> , dissecting scissors	85	Micro scissors	48-53, 55, 57-60, 747, 749, 768
DUROTIP dissecting scissors	95, 101	Micro suture tying forceps	139, 140, 143
NOIR dissecting scissors	105	Micro vein scissors	51
NOIR dissecting scissors, Wavecut	107	<b>MICRO-ADSON</b> , delicate dissecting forceps	151, 152
<b>MAYO-NOBLE</b> , dissecting scissors	84	delicate tissue forceps	168, 169
<b>MAYO-ROBSON</b> , ATRAUMATA intestinal clamps	555	dissecting and ligature forceps	244
intestinal clamps	555	<b>MICRO-ADSON-BIEMER</b> , delicate tissue forceps	168
<b>MAYO-STILLE</b> , dissecting scissors	82, 83	<b>MICRO-HALSTED</b> , hemostatic forceps	220
<b>MC CLINTOCK</b> , placenta- and ovum forceps	735	Microsurgical blades	45
<b>MC CLURE</b> , micro scissors	48	<b>MIDDELDORPF</b> , cheek retractors	406
<b>MC GIVNEY</b> , hemorrhoidal forceps	585	<b>MIKULICZ</b> , abdominal retractors	437, 438
<b>MC INDOE</b> , bone cutting forceps	1040	peritoneum forceps	257-259
delicate dissecting forceps	154	tonsil forceps	240
delicate tissue forceps	172	<b>MILLER</b> , bone rasps	979
fine retractors	361	<b>MILLESİ</b> , micro scissors	52
monopolar diathermy forceps	517	<b>MILLIN</b> , ATRAUMATA lobe grasping forceps	622
<b>MC KENTY</b> , raspatories	960	bladder neck spreaders	622
<b>MC KENZIE</b> , burrs	1052, 1053	bladder retractors	496, 617
perforators	1053	ligature holding forceps	326, 622
<b>MC KISSOCK</b> , raspatories	971	<b>MILLS</b> , cardiovascular scissors	111
<b>MEAD</b> , bone rongeurs	1029	gall duct scissors	597
mallets	992	Mills, hollow	1057
raspatories	966	MIOS, hip retractors	947-959
Measures, medical	1108	Mirrors, head	2
<b>MEHDORN</b> , clip applying forceps	210	laryngeal	5
vessel clips	210	rhinoscopic	5
Membrane puncturing forceps	722	<b>MITCHELL</b> , raspatories	973
Meniscus forceps	1043	<b>MIXTER</b> , dissecting and ligature forceps	253, 255, 841
Meniscus knives	1044	gall duct- and cystic forceps	593
Mercedes retractors	874	<b>MIXTER-O'SHAUGNESSY</b> , dissecting and ligature forceps	249
<b>METZENBAUM</b> , delicate dissecting scissors	62	<b>MOD. BERLIN</b> , endometrial biopsy curettes	698
dissecting scissors	87	<b>MOD. MÜNCHEN</b> , endometrial biopsy curettes	698
DUROTIP dissecting scissors	97, 98	<b>MOD. USA</b> , plaster spreaders	1087
DUROTIP dissecting scissors, Wavecut	102, 103	Modular handle	959
NOIR delicate dissecting scissors	105	<b>MOLLISON</b> , self-retaining retractors	464
NOIR dissecting scissors	105	<b>MOLT</b> , raspatories	966
NOIR dissecting scissors, Wavecut	107	Monopolar connecting cable	522
SuperCut scissors	91	Monopolar diathermy forceps	516-518, 520
<b>MEYER</b> , reposition forceps	1015	Monopolar scissors	515
<b>MEYERDING</b> , retractors	371, 416	<b>MORRIS</b> , ATRAUMATA aorta clamps	811
<b>MICHEL</b> , clip applying forceps	352	ATRAUMATA sigmoid anastomosis forceps	563
rhinoscopic mirrors	5	retractors	415
suture clips	352	<b>MORSE</b> , sternum retractors	872
<b>MICHEL MODIF.</b> , clip applying and removing forceps	352	Mounting frames, abdominal retractors	449
Micro dissecting scissors	53	Mouth gags	14, 15
Micro forceps	141, 142, 145, 147, 150, 753, 755, 757, 769	<b>MOYNIHAN</b> , gall duct forceps	592
Micro forceps, jeweler patterns	138		

# Alphabetischer Index – Alphabetical Index

M – O

A – Z

	Page		Page
<b>MOYNIHAN</b> , gall duct probes	598	Needle holders, with scissors, DUROGRIP	311
hemostatic forceps	223, 239	Needles	327, 328
intestinal clamps	553	Needles, guide	353
Multi-purpose clamps, ATRAUMATA	791-793, 809, 810, 824, 825, 828, 833, 834	intestinal	278
<b>MURPHY</b> , head bands	2	ligature	329-336, 1056
retractors	391	pudendus block	721
<b>MURPHY-LANE</b> , luxation levers	945	sternal puncture	634, 855
<b>MUSEUX</b> , organ- and tissue grasping forceps	197	sub-mucosal resection	515
uterine tenaculum forceps	678, 683, 684	surgical	276-278
<b>MÜHLING</b> , bone shears	116	<b>NEGUS</b> , suction dissectors	1103
raspatories	969	tonsil forceps	240
<b>MÜLLER</b> , abdominal retractor	442	<b>NELATON</b> , directors	342
ATRAUMATA rectal anastomosis clamp	566	<b>NELSON</b> , lung grasping forceps	180, 838
ATRAUMATA vascular clips	214, 215, 784, 785	<b>NELSON-METZENBAUM</b> dissecting scissors	88
DUROGRIP needle holders	317, 568	DUROTIP dissecting scissors	97
DUROGRIP suture forceps	178	DUROTIP dissecting scissors, Wavecut	102, 103
fine retractors	361	<b>NELSON-METZENBAUM (MC INDOE)</b> ,	98
micro forceps	141, 142	DUROTIP dissecting scissors	
micro needle holders	285	Nerve approximators	212
micro scissors	55	Nerve dissecting scissors	63, 79
rectal scissors	127, 567	Nerve hooks	356-359
vessel clips	213	Nerve root retractors	376
Myoma screws	690	<b>NIEDERDELLMANN</b> osteotomes	1005
Myrtle leaf probes	344	<b>NISSEN</b> , dissecting and ligature forceps	245, 256
		gall duct- and cystic forceps	591
		hemostatic forceps	225
		NOIR dissecting scissors	105
		NOIR dissecting scissors, Wavecut	106, 107
		<b>NORFOLK and NORWICH</b> ,	468
		self-retaining laminectomy retractors	
<b>N</b>		<b>NORTHBENT</b> , ligature scissors	128
<b>NABATOFF</b> , vein stripper set	887	<b>NORTHFIELD</b> , bone rongeurs	1031
Nail cutters	12	<b>NOTO</b> , organ- and tissue grasping forceps	193
Nail extracting forceps	1079	polypus and ovum forceps	686
Nail files	13	sponge holding and dressing forceps	193
Nail scissors	11, 12, 130	<b>NOVAK-SCHOECKAERT</b> endometrial biopsy curettes	698
Nail splitting forceps	1079	<b>NOYES</b> , micro scissors	48
Nail splitting scissors	75, 1079	<b>NUSSBAUM</b> , intestinal clamps	553
Nasal dressing forceps	165-167	<b>NÄGELE</b> , obstetrical forceps	726
Nasal knives	32		
Nasal tampon forceps	184	<b>O</b>	
<b>NAUNTON MORGAN</b> , DUROGRIP needle holders	317	<b>O'SHAUGNESSY</b> , dissecting and ligature forceps	249, 252
rectal specula wit cold light	574	<b>O'SULLIVAN-O'CONNOR</b> abdominal retractors	489
Needle cases	279	Obstetric levers	730
Needle electrodes	509-512, 514	Obstetrical forceps	726-729
Needle holders	299-303, 305	<b>OBWEGESER</b> awls	1056
Needle holders with scissors	304	osteotomes	1005
Needle holders, boomerang	326, 623	retractors	401, 402
DIADUST	289, 291, 293, 295-298, 759, 761, 765-767, 769	<b>OCHSNER</b> , ATRAUMATA aorta clamps	817
DUROGRIP	286, 287, 307-310, 312-325, 568, 773-779	gall duct probes	599
micro	282-285, 287, 289, 291, 293, 295-298, 759, 761, 765-767, 769-772, 774	ligature forceps	158
with scissors	304	<b>OFFICER</b> , tissue forceps	176



## Alphabetischer Index – Alphabetical Index

O – P

A – Z

	Page		Page
Offset scissors	111	<b>PELKMANN</b> , foreign body forceps	200
Oil, instruments	1112	gall stone forceps	604
<b>OLDBERG</b> , rongeurs	908	uterine dressing forceps	672
<b>OLIVECRONA</b> , bone rongeurs	1030	Pelvimeters	720
trigeminal knives	31	Pelvis retractors	440, 441, 578
wire saws	924	<b>PENFIELD</b> , dissectors	928, 929
<b>OLLIER</b> , retractors	394	Penis clamps	625
<b>OMBREDANNE</b> , mallets	996	<b>PENNINGTON</b> , hemostatic forceps	241
Organ grasping forceps	190, 192, 193, 197–199, 540, 543	intestinal grasping forceps	542
Organ grasping forceps, ATRAUMATA	191, 544, 545, 835–837	<b>PENNYBACKER</b> , bone rongeurs	1031
<b>ORMROD-SCHMITT</b> , ligature disc	1065	dissectors	929
Osteophyte chisels	962	raspatories	972
Osteotomes	998, 999, 1001–1005, 1007, 1008, 1010	rongeurs	903
Osteotomes, fishtail	1001	<b>PERCY</b> , amputation retractors	920
<b>OVERHOLT</b> , dissecting and ligature forceps	247	Perforators	1053
<b>OVERHOLT-GEISSENDOERFER</b> , dissecting and ligature forceps	246	Perineal retractors	577
<b>OVERHOLT-MIXTER</b> , dissecting and ligature forceps	246	Periosteum knives	29, 918
Ovum curettes	713	Peripheral vascular clamps, ATRAUMATA	805–807
Ovum forceps	685–688, 732–735	Peritoneum forceps	257–260
Ovum forceps, ATRAUMATA	687	<b>PERKINS</b> , self-retaining retractors	463
Ovum scoops	712	<b>PERTHES</b> , reamers	1055
<b>O'CONNELL</b> , dissectors	929	<b>PERWITZSCHKY</b> , salival scissors	68
<b>O'SULLIVAN-O'CONNOR</b> , abdominal retractors	489	Phalangeal knives	29, 918
<b>P</b>		<b>PHANEUF</b> , hysterectomy forceps	260
Pankreas clamps, ATRAUMATA	796	Phleb extractors	889
Parametrium clamps	270, 271, 692, 693	Phlebo dissectors	889
Parametrium clamps, ATRAUMATA	268, 269	<b>PICCOLO</b> , cotton applicator	348
Parametrium scissors	120, 121, 692, 693	Pick-up forceps	19
<b>PARKER</b> , retractors	379, 380	Picks, tissue	363
<b>PARKER-KERR</b> , anastomosis forceps	560	Pins	1063
<b>PARRY-COOLEY</b> , ATRAUMATA anastomosis clamps	830	Pins, safty	207
<b>PARSONNET</b> , epicardial retractors	457	<b>PIPER</b> , obstetrical forceps	727
<b>PARTSCH</b> , chisels	1000	<b>PITHA</b> , foreign body forceps	200, 626
gouges	1000	Placenta curettes	713
raspatories	960	Placenta forceps	732–735
<b>PARTSCH MOD. LANGE</b> , raspatories	960	Placenta scoops	712
<b>PASSOW</b> , tampers	997	Plaster breakers	1087
Patella forceps	1016	Plaster knives	1082
Patent ductus clamps, ATRAUMATA	805, 806, 826, 827	Plaster saws	1082
<b>PAUL</b> , tendon hooks	373	Plaster scissors	134, 135, 1083, 1084
<b>PAYR</b> , guiding probes	337	Plaster shears	1085, 1086
intestinal and pylorus clamps	558	Plaster spreaders	1087
<b>PEAN</b> , ATRAUMATA hemostatic forceps	795	Plastic scissors	77
hemostatic forceps	231, 232, 234, 239	Plate electrodes	510
kidney clamps	609	<b>PLESTER</b> , self-retaining retractors	462
tubing clamps	17	suction cannula	1095
<b>PEDERSON</b> , vaginal specula	640	Pliers, flat-nosed	1069, 1070
Pediatric clamps, ATRAUMATA	821	wire bending	1069, 1071
		wire cutting	1072–1078
		wire extraction	1070, 1071
		<b>POIRIER</b> , tissue grasping forceps	196
		Polypus forceps	685–688
		Polypus forceps, ATRAUMATA	687
		<b>POOL</b> , suction cannula	1093

# Alphabetischer Index – Alphabetical Index

P – R

A – Z

	Page		Page
Poplitea retractors	497	<b>RAMSEY</b> , dissecting forceps	158
Pot, ink	25	tissue forceps	177
<b>POTTS</b> , dissecting scissors	80	<b>RANDALL</b> , endometrial biopsy curettes	698
<b>POTTS-DE MARTEL</b> , cardiovascular scissors	111	kidney stone forceps	614-616
gall duct scissors	597	<b>RANKIN</b> , hemostatic forceps	224
vascular scissors	110	Raspatories	960-977
<b>POTTS-DIETRICH</b> , vascular scissors	108, 109, 751	Raspatories, rib	861-863
<b>POTTS-SMITH</b> , cardiovascular scissors	111	suction	1103
vascular scissors	114	Rasps, bone	978-980
<b>POZZI</b> , uterine tenaculum forceps	676	Razors	9
uterine tenaculum forceps	674	Reamers	1055, 1056
<b>PRATT</b> , organ- and tissue grasping forceps	198	<b>RECAMIER</b> , placenta- and ovum curettes	713
rectal specula	571	uterine curettes	708
uterine tenaculum forceps	680	Rectal anastomosis forceps, ATRAUMATA	566
Pressure clamps	273, 584, 612	Rectal probes	342, 343, 579
Pressure clamps, ATRAUMATA	272, 560, 612	Rectal retractors	573
<b>PRICE THOMAS</b> , bronchus forceps	845	Rectal scissors	125-127, 565, 567
Probes	344-347, 579	Rectal specula	570, 571, 573
Probes, double ended	346	Rectal specula, cold light	574
fistula	343, 579	Rectal spreaders	576
gall duct	598, 599	Retractor blades, VARIO	420
guiding	336-338	Rectum biopsy forceps	581, 582
myrtle leaf	344	<b>REDON</b> , guide needles	353
rectal	342, 343, 579	<b>REILL</b> , micro needle holders	284, 772
sinus	345	reposition forceps	1015
tendon passing	1048	tendon strippers	1046
uterine	670, 671	wire cutting pliers	1076
Proctoscopes	573, 575	<b>REIN/KUPKA</b> , DUROGRIP needle holders	321, 775
Profunda clamps, ATRAUMATA	798	<b>REMINGTON-HOBBS</b> , monopolar diathermy forceps	518
Prostate retractor	452, 620	Removing Hooks, I.U.D.	697
<b>PROVIDENCE-HOSPITAL</b> , hemostatic forceps	221	Reposition forceps	1014-1016
Pudendus block needles	721	Reposition tampers	1015
Punches, aorta	852	<b>RESANO</b> , ATRAUMATA sigmoid anastomosis forceps	564
bone	892-898	cartilage scissors	89
dermal	33	Resection knives	29, 918
Puncture needles, sternal	855	Resection needles, sub-mucosal	515
<b>PUTTI</b> , bone files	980	Retractor spine, self-retaining	476
Pylorus clamps	558	Retractors, mercedes	874
Pylorus spreaders	557	Retractors	366, 370-411, 413-419, 422, 423, 425, 427-434, 437-439, 443-446, 457, 569, 946, 1025
		Retractors, abdominal	437-439, 442-448, 482, 483, 485-495
		abdominal, fixation device	448
		abdominal, mounting frame	449
		amputation	920
		aorta valve	884
		atrium	882, 883
		bladder	496, 617
		bone	387, 388
		<b>CARBOTRAC</b>	412
		cheek	378, 405-407
		dura	360, 363
		femur	473
<b>Q</b>			
<b>QUERVAIN</b> elevators	931		
<b>QUINBY</b> , delicate scissors	67		
<b>R</b>			
<b>R.N.O.H.</b> , bone biopsy trephine	1057		
Racks, sterilizing	33, 919		
<b>RAGNELL</b> , delicate dissecting scissors	63		
retractors	379		
<b>RAMPLEY</b> , sponge holding and dressing forceps	190		



## Alphabetischer Index – Alphabetical Index

R – S

	Page		Page
Retractors, fine	360-363	<b>ROEDER</b> , towel clamps	203
hemi-laminectomy	469	<b>ROLLET</b> , skin hooks	360
hip	947-959	Rongeurs	899-912
knee	399, 400, 1045	Rongeurs, bone	1026-1037
laminectomy, self-retaining	468, 470, 471, 476, 478	rib	860
lid	458	synovectomy	1026
mammaria	876	<b>ROSE</b> , retractors	379
MIOS	947-959	<b>ROSER-KÖNIG</b> , mouth gags	15
nerve root	376	<b>ROTUNDA</b> , uterine irrigation catheters	717
pelvis	440, 441, 578	Round bowls	1108
poplitea	497	<b>ROUX</b> , retractors	381-383
prostate	452, 620	<b>ROWBOTHAM</b> , suction cannula	1101
scapula	426, 880	<b>RUDD</b> , hemorrhoidal ligators	585
self-retaining	456-467, 472, 473, 768	Rulers	7
self-retaining, iliaca	475	Rulers, x-ray	7
self-retaining, laminectomy	468-471, 476-478	<b>RUMEL</b> , dissecting and ligature forceps	251
skin	363, 473	<b>RUMEL-BELMONT</b> , tourniquets	851
spine, self-retaining	478-480	<b>RUSKIN</b> , bone rongeurs	1032
sternum	872, 873, 876	<b>RUSKIN-LISTON</b> , bone cutting forceps	1040
thoracic	864, 865, 874	<b>RUSS. MODELL</b> , tissue forceps	179
thyroid	472	<b>RUST</b> , amputation saws	921
tracheal	364-366	<b>RYDEL-SEIFFER</b> , tuning fork	6
treangle handle	367-369	<b>RYDER, DIADUST</b> needle holders	298, 767
urethral	452, 620	DUROGRIP needle holders	319, 320, 778, 779
vaginal	472, 473, 659	<b>RÖTTGEN-RUSKIN</b> , bone rongeurs	1032
vein	373-376		
<b>REVERDIN</b> , abdominal and intestinal spatula	450		
needles	328		
suture instruments – reverdin needles	327		
<b>REYNOLDS</b> , dissecting scissors	80	<b>S</b>	
<b>REYNOLDS-JAMESON</b> , vascular scissors	63	Saddle hooks	369
Rhinoscopic mirrors	5	<b>SAENGER</b> , placenta and ovum forceps	733
Rib contractors	877	Safty pins	207
Rib holding forceps	859	Salival scissors	68
Rib raspatories	861-863	Salpingograph	715
Rib rongeurs	860	<b>SAROT, DUROGRIP</b> needle holders	309
Rib shears	857, 858	hemostatic forceps	229
Rib spreaders	865-871, 877	intrathoracic artery forceps	238
<b>RIBBON</b> , spatulas, malleable	450	<b>SATINSKY</b> , anastomosis clamps	843
<b>RICARD</b> , abdominal retractors	483	ATRAUMATA pediatric clamp	821
<b>RICHARDSON</b> , retractors	413, 414	vascular scissors	115
<b>RICHARDSON-EASTMAN</b> , retractors	413	<b>SATTERLEE</b> , amputation saws	923
<b>RICHES</b> , monopolar forceps	520	<b>SAUER</b> , lid retractors	458
Rings, ligature rubber	585	<b>SAUERBRUCH</b> , pick up forceps	19
<b>RNTNE HOSPITAL</b> , self-retaining retractors	463	retractors	404, 425
<b>ROBERTS</b> , hemostatic forceps	238	rib shears	857
raspatories	966	<b>SAUERBRUCH-CORYLLOS</b> , bone rongeurs	860, 1037
<b>ROBIN</b> , towel clamps	204	<b>SAUNDERS</b> , I.U.D. removing hooks	697
<b>ROCHARD</b> , abdominal retractors	448	Saw blades	921, 922
fixation device for abdominal retractors	448	Saws, amputation	922, 923
mounting frame for abdominal retractors	449	finger ring	1079
<b>ROCHESTER-CARMALT</b> , hemostatic forceps	237	plaster	1082
<b>ROCHESTER-OCHSNER</b> , hemostatic forceps	235	wire	924
<b>ROCHESTER-PEAN</b> , hemostatic forceps	233	Scalp flap forceps	731
		Scalpel blades	42, 43

A - Z

# Alphabetischer Index – Alphabetical Index

## S

	Page		Page
Scalpel blades, microsurgical	45	Scissors, DUROTIP	92-100, 597
Scalpel handles	38-41, 618	DUROTIP ligature	104
Scalpel handles, micro	44, 45	DUROTIP Wavecut	101-103
Scalpels	26, 27	enucleation	77
Scalpels, disposable	22-24	episiotomy	124, 724
micro	24	eye	49
Scapula retractors	426, 880	gall bladder	596
<b>SCHAEDEL</b> , towel clamps	201	gall duct	597
<b>SCHUDE</b> , bone curettes	984	gynecology	117-121
<b>SCHERBACK</b> , vaginal specula	657	hysterectomy	120
<b>SCHINK</b> , skin grafting knives	34	hysterectomy, DUROTIP	100
<b>SCHMELZ</b> , gestation calculators	720	incision	75
<b>SCHMID</b> , mouth gags	14	ligature	60, 92, 128
vascular spatula	850	ligature, DUROTIP	101
vessel irrigation cannula	846	lower lateral	77
<b>SCHMIEDEN</b> , guiding probes	337	micro	48-53, 55, 57-60, 747, 749, 768
<b>SCHMIEDEN-TAYLOR</b> , dura scissors	112	monopolar	515
<b>SCHNEIDER-SAUERBRUCH</b> , raspatories	973	nail	11, 12, 130
<b>SCHNIDT</b> , hemostatic forceps	240	nail splitting	75, 1079
tonsil forceps	240	nerve dissecting	63, 79
<b>SCHOEMAKER</b> , colectomy clamps	554	NOIR	105-107
<b>SCHOENBORN</b> , wound and vein retractors	375	offset	111
<b>SCHRÖDER</b> , organ- and tissue grasping forceps	197, 199	parametrium	120, 121, 692, 693
uterine scoops	707	plaster	134, 135, 1083, 1084
uterine tenaculum forceps	676, 678, 679	plastic	77
<b>SCHUBERT</b> , biopsy forceps	699	rectal	125-127, 565, 567
<b>SCHUHKNECHT</b> , suction cannula	1097	salival	68
<b>SCHULZE</b> , salpingograph	715	strabismus	76
<b>SCHUMACHER MOD. WAGNER</b> , bone levers	943	SuperCut	90, 91
<b>SCHUMACHER</b> , biopsy forceps	701	surgical	71-75, 82
biopsy tips	705	surgical, DUROTIP	93, 101
bone levers	944	surgical, heavy patterns	122
sternum shears	855	tendon	78
umbilical cord scissors	123, 723	umbilical cord	123, 723
<b>SCHWEDISCHES MODELL</b> , dissecting forceps	157	uterine	99, 103, 117-120
Scissors, abdominal	122	vascular	63, 78, 108-115, 751
anatomy	68	vascular, DUROTIP	100
arteriotomy	80	vein	51
bandage	131-133, 1082	Wavecut	102
bipolar dissecting	530	Wavecut, DUROTIP	101
bowel	125	Wavecut, NOIR	106, 107
bulldog	76	wire cutting	129, 1073
cardiovascular	108-111, 114	wire cutting, DUROTIP	100, 102, 1072
cartilage	81, 89	Scoops, blood	453
cloth	132-135, 1082	gall stone	602
coronary	57-59	ovum	712
delicate	61, 63-70, 92	placenta	712
dissecting	77, 79, 80, 82-89, 618	secretion	626
dissecting, delicate	62, 63, 76, 78, 80, 81	uterine	707
dissecting, DUROTIP	94-99, 101-103	uterine secretion	697
dissecting, micro	53	<b>SCOVILLE-HAVERFIELD</b>	476
dissecting, NOIR	105-107	self-retaining laminectomy retractors	
dura	112	<b>SCOVILLE-RICHTER</b> , laminectomy retractors	477
		Screws, myoma	690





## Alphabetischer Index – Alphabetical Index

S

	Page		Page
<b>SCUDDER</b> , ATRAUMATA stomach clamps	557	<b>SIMS</b> , uterine scissors	99
<b>SEBILEAU</b> , elevators	931	vaginal specula	640
Secretion scoops	626, 697	<b>SIMS-MAIER</b> , sponge- and dressing forceps	188
<b>SEDILLOT</b> , raspatories	971, 973	<b>SIMS-SIEBOLD</b> , uterine scissors	120
<b>SEGOND</b> , hysterectomy forceps	265	Single use electrode handle	508
<b>SEGOND-LANDAU</b> , hysterectomy forceps	264	Single use scalpels	22-24
<b>SEIDEL</b> , vaginal specula	641	Sinus forceps	184
<b>SEIDL</b> , biopsy forceps	702	Sinus probes	345
<b>SEIFFERT</b> , probes	347	Skin grafting knives	34, 35
<b>SELDIN</b> , raspatories	966	Skin hooks	360-363
Self-retaining retractors	456-467, 469, 472, 768	Skin retractors	473
Self-retaining retractors, laminectomy spine	468, 470, 471, 476-478 478-480	<b>SMILLIE</b> , knee retractors	399, 1045
<b>SELLHEIM</b> , obstetric levers	730	meniscus knives	1044
<b>SELLORS</b> , rib spreaders and contractor	877	<b>SMITH</b> , bandage scissors	131
<b>SELMAN</b> , tissue forceps	179	<b>SMITH-BUIE</b> , rectal retractors	573
<b>SEMB</b> , bone holding forceps	1018	<b>SMITH-PETERSEN</b> , osteotome	1004
bone rongeurs	860, 1036	<b>SOMER</b> , uterine elevating forceps	689
dissecting and ligature forceps	840	<b>SPACKMAN</b> , uterine cannula	716
raspatories	975	Spatula	348, 369
rib holding forceps	859	Spatula, abdominal	435, 436, 450, 451
rib raspatories	862	bladder	496, 617
<b>SEMKEN</b> , delicate dissecting forceps	154	intestinal	435, 436, 450, 451
delicate tissue forceps	171	lung	422-426, 878, 879, 881
<b>SEMM</b> , abdominal retractors	491	malleable	450
vaginal specula	639	tongue	4, 348
<b>SENN-MILLER</b> , retractors	377	vascular	850
Sequestrum forceps	1017	Spatulas, vascular	849
<b>SEUTIN</b> , plaster scissors	134, 1084	Specula, rectal	570, 571, 573
<b>SEWALL</b> , elevators	963	rectal, cold light	574
<b>SEYFFERT</b> , vaginal specula	639	vaginal	636-658
Shears, bone	116	<b>SPENCER</b> , ligature scissors	128
plaster	1085, 1086	<b>SPENCER-WELLS</b> , hemostatic forceps	232
rib	857, 858	Spermatic cord fixation clamps	625
sternum	855, 856	Spermatic cord hooks	625
<b>SIEBOLD</b> , uterine scissors	119	Sphincteroscopes	572
Sigmoid anastomosis forceps	561-563	Spine retractors, self-retaining	476, 478-480
Sigmoid anastomosis forceps, ATRAUMATA	564	Splinter forceps	181
Sigmoidoscopes	575	Sponge forceps	10, 184-190, 192, 193
<b>SILVER</b> , skin grafting knives	35	Spongiosa gouges	1008-1010
<b>SIMON</b> , bone curettes	988	Spoons, ureter	691
fistula hooks	372	Spreaders, bladder neck	622
fistula knives	30	lamina	481
retractors	417	perineal	577
uterine scoops	707	plaster	1087
vaginal specula	655	pylorus	557
<b>SIMPSON</b> , obstetrical forceps	728	rectal	573, 576
uterine probes	671	rib	865-871, 877
<b>SIMPSON-BRAUN</b> , obstetrical forceps	727	<b>SPURLING</b> , rongeurs	902, 906
<b>SIMS</b> , DUROTIP uterine scissors, Wavecut	103	<b>ST. BARTS</b> , ear hooks	356
gynecology scissors	117, 118	rongeurs	900, 901
rectal specula	570, 571	<b>ST. MARKS</b> , pelvis retractors	440, 441, 578
uterine curettes	709	<b>ST. MARKS MODIF. GIRONA</b> , perineal retractors	577
uterine probes	670	<b>ST. MARTIN</b> , delicate tissue forceps	168
		<b>STACKE</b> , probes	347

A - Z

# Alphabetischer Index – Alphabetical Index

S – T

A – Z

	Page		Page
<b>STAMM</b> , bone cutting forceps	1038	Surgical scissors, heavy pattern	122
<b>STANDARD</b> , DUROGRIP dissecting forceps	164	Suture clips	352
<b>STEINMANN</b> , pins	1063	Suture forceps, DUROGRIP	163, 178
<b>STELLBRINK</b> , synovectomy-rongeurs	1026	Suture holding frame	621
<b>STELZNER</b> , rectal scissors	126, 565	Suture tying forceps	139, 143
Sterile scalpels	22-24	Suture tying forceps, micro	139, 140
<b>STERILIT</b> , instruments oil	1112	Swab holders	582
Sterilizing forceps	1109	<b>SWEDISH</b> , dissectors	929
Sterilizing racks	33, 919	<b>SYME</b> , ligature needles	334
Sternal puncture needles	634, 855	raspatories	966
<b>STERNBERG</b> , retractors	378	Synovectomy rongeurs	1026
Sternum chisels	856	<b>SYPERT</b> , bone rongeurs	1035
Sternum retractors	872, 873, 876	punches	895
Sternum shears	855, 856	rongeurs	912
<b>STEVENS</b> , delicate dissecting scissors	62, 78	Syringes, hemorrhoidal	587
vascular- and tendon scissors	78	<b>SYSTRUNK</b> , nail splitting scissors	75, 1079
<b>STIEGLITZ</b> , splinter forceps	181		
<b>STILLE</b> , bone rongeurs	1034	<b>T</b>	
chisels	1003	<b>TAKAHASHI</b> , rongeurs	901
dissecting scissors	85	Tampers	997
gouges	1003	Tampers, reposition	1015
kidney clamps	610	Tangential occlusion clamps, ATRAUMATA	801, 802
osteotomes	1003	<b>TARNIER</b> , obstetrical forceps	729
plaster shears	1086	<b>TAYLOR</b> , retractors	946
<b>STILLE-AESCLAP</b> , plaster shears	1085	<b>TEALE</b> , uterine tenaculum forceps	681, 682
<b>STILLE-BARRAYA</b> , tissue grasping forceps	543	Tendon double hooks	369
vascular- and tumor forceps	179	Tendon hooks	373
<b>STILLE-RUSKIN</b> , bone rongeurs	1034	Tendon interlacing forceps	194
Stitch-cutters	43	Tendon passing probes	1048
<b>STOCKMANN</b> , penis clamps	625	Tendon scissors	78
Stomach clamps, ATRAUMATA	557	Tendon seizing forceps	194, 195
Strainer for tissue	714, 1090	Tendon strippers	1046, 1047
<b>STRANDELL-STILLE</b> , tendon hooks	373	Tenotomes	27
<b>STRASSBURGER MODELL</b> , tissue forceps	178	<b>THOMS-GAYLOR</b> , biopsy forceps	699
<b>STRATTE</b> , DUROGRIP needle holders	315	Thoracic retractors	864, 865, 874
<b>STRAUSS</b> , penis clamps	625	<b>THOREK</b> , vascular scissors	114
Stripper, vein	887, 888	<b>THORPE</b> , corneal forceps	151
Strippers, endarterectomy	851	Thyroid retractors	472
tendon	1046, 1047	Tier, knot	339
<b>STRUCK</b> , rib spreader	865	Tighteners, wire	1065
<b>STRULLY</b> , vascular scissors	112, 113	Tips, biopsy	705
<b>SUBRAMANIAN (MODIF.)</b> , ATRAUMATA aorta clamps	816	<b>TISCHLER</b> , biopsy forceps	706
Suction adapter	1099	Tissue forceps	170, 173-179
Suction cannula	885, 886, 1091-1102, 1104, 1105	Tissue forceps, delicate	168, 169, 171, 172
Suction dissectors	1103	Tissue grasping forceps	190, 192, 193, 196-199, 538-540, 543
Suction dissectors, tonsil	1103	Tissue grasping forceps, ATRAUMATA	191, 544, 545, 835-837
Suction heads, vacuum extraction	725	Tissue pick	363
Suction hose	714, 1090	Tissue strainer	1090
Suction raspatories	1103	Titanium ligature clip	738, 740, 742, 744
Suction tubes, dissecting	1103	Tongue forceps	16
SuperCut scissors	90, 91	Tongue spatula	4, 348
Surgical needles	276-278		
Surgical scissors	71-75, 82		
Surgical scissors DUROTIP	93, 101		



# Alphabetischer Index – Alphabetical Index

T - V

A - Z

	Page		Page
Tonsil forceps	240	<b>U</b>	
Tonsil knives	31	<b>UCHIDA MODIF. BURKE</b> , ureter spoons	691
Tonsil suction dissectors	1103	<b>UFFENORDE</b> , bone curettes	983
Tourniquet	851	<b>ULRICH</b> , fistula knives	30
Towel clamps	201-206	<b>ULRICH-AESCULAP</b> , sponge- and dressing forceps	186
Tracheal dilators	474	Ultra-light forceps, ATRAUMATA	159, 546, 781
Tracheal hooks	364	Umbilical cord clamps	724
Tracheal retractors	364-366	Umbilical cord scissors	123, 723
Traction bows	1060-1062	Umbilical dilators	724
Transformer	3	Universal trocars	634
<b>TRAVERS</b> , self-retaining retractors	467	Ureter forceps, ATRAUMATA	624
Trays, kidney	1108	Ureter spoon	691
<b>TRELAT</b> , raspatories	961	Urethral bougies and dilating sounds	629, 630
vaginal specula	638	Urethral retractor	452, 620
Trephines, bone biopsy	1057	Urethral tunnel clamps	254, 691
<b>TREVES</b> , tissue forceps	177	Urinary catheters	627
Trigeminal knives	31	<b>US-ARMY</b> , retractors	386
Trocars	634	Uterine cannulas	716, 717
Trocars, universal	634	Uterine curettes	708-711
<b>TROELTSCH</b> dissecting forceps, angular	167	Uterine depressors	671
<b>TROTTER</b> , bone rongeurs	1030	Uterine dilators	662-666
<b>TROUSSEAU</b> , tracheal dilators	474	Uterine dressing forceps	672, 673, 675
Tubing clamps	17, 18	Uterine elevating forceps	688, 689
<b>TUDOR-EDWARDS</b> , abdominal retractors	443	Uterine irrigation catheters	717
<b>TUFFIER</b> , abdominal and intestinal spatula	450	Uterine probes	670, 671
abdominal retractors	443	Uterine scissors	99, 103, 117-120
artery grasping forceps	196	Uterine scissors, DUROTIP	103
intestinal and tissue grasping forceps	196, 538	Uterine scoops	707
rib spreaders	866, 867	Uterine secretion scoops	697
Tumor forceps	179	Uterine tenaculum forceps	674, 676-678, 681-684
Tumor grasping forceps	909		
Tuning forks	6	<b>V</b>	
Tunnelling instruments	853	Vacuum curettes	714, 1090
<b>TURNER</b> , monopolar diathermy forceps	517	Vacuum extraction, suction heads	725
<b>TURNER-WARWICK</b> , abdominal retractors	492, 493	Vaginal clamps, ATRAUMATA	267
urethral sound	629	Vaginal retractors	472, 473, 659
<b>TUTTLE</b> , lung grasping forceps	180, 838	Vaginal specula	636-658
Twin clamps	556	<b>VALLEIX</b> , uterine probes	671
Twist drills	1054	<b>VANNAS</b> , micro scissors	48, 50, 52
Twisters, wire, DUROGRIP	312, 1067, 1068	<b>VARADY</b> , mini vein strippers sets	888
<b>TÜBINGER MODELL</b> , gall stone forceps	605	phleb extractors	889
retractors	417	VARIO, retractor system	420, 421
vaginal specula	655	Vascular clamps, ATRAUMATA	790-801, 803-834
<b>TÄGER</b> , bone levers	944	Vascular clips, ATRAUMATA	214, 215, 784, 785
<b>TÖNNIS</b> , dissecting scissors	81	Vascular dilators	847, 848
dura retractors	360	Vascular forceps	179
DUROGRIP, needle holders	322	Vascular prosthesis draw-in forceps	854
grooved director	929	Vascular scissors	63, 78, 108-115, 751
needle holders	305	Vascular scissors, DUROTIP	100
vascular spatula	850	Vascular spatulas	849, 850
<b>TÖNNIS MODIF.</b> , DUROGRIP, needle holders	322	Vein hooks	357
<b>TÖNNIS-ADSON</b> , dissecting scissors	80	Vein retractors	373-376
DUROTIP dissecting scissors	96		
DUROTIP dissecting scissors, Wavecut	102		

# Alphabetischer Index – Alphabetical Index

V – W

A – Z

	Page		Page
Vein scissors	51	<b>WERTHEIM</b> , gynecology scissors	118
Vein strippers	887, 888	hysterectomy forceps	263, 264, 270
Vena cava clamps, ATRAUMATA	800	kidney pedicle clamps	611
Venous plexus clamp	619	<b>WERTHEIM-CULLEN</b> compression forceps	273
<b>VERBRUGGE</b> , bone holding forceps	1023	kidney pedicle clamps	612
<b>VERBRUGGE-MÜLLER</b> bone levers	938	<b>WIENER MODELL</b> , hysterectomy forceps	262
<b>VERHOEVEN</b> suction cannula	1099	<b>WIKSTROEM</b> , dissecting and ligature forceps	250, 840
Vessel clips	210, 213	<b>WILDE</b> , dissecting forceps, angular	167
Vessel hooks	356-359	<b>WILLETT</b> , scalp flap forceps	731
Vessel irrigation cannula	846	<b>WILLIAMS</b> , lung grasping forceps	838
<b>WISE</b> , micro suture tying forceps	139	organ- and tissue grasping forceps	543
<b>VOLKMANN</b> , bone curettes	981, 984	<b>WILLIGER</b> , bone curettes	981, 984
bone retractors	387, 388	elevators	930
retractors	387-389	raspatories	961
		<b>WILSON</b> , organ- and tissue grasping forceps	199
		tonsil forceps	240
		uterine tenaculum forceps	676
		<b>WILSON-HEY</b> , monopolar forceps	520
		<b>WINKELMANN</b> circumcision clamps	631
		<b>WINTER</b> , placenta- and ovum forceps	732
		Wire bending pliers	1069, 1071
		Wire brush	523
		Wire cutters	1072-1074, 1076, 1077
		Wire cutting forceps	1068
		Wire cutting pliers	1072-1078
		Wire cutting pliers, front cutting action	1077
		lateral cutting action	1075, 1076
		Wire cutting scissors	129, 1072, 1073
		Wire cutting scissors, DUROTIP	100, 1072
		Wire extraction pliers	1070
		Wire guides	1066
		Wire holding forceps	1070, 1071
		Wire holding forceps, DUROGRIP	1067
		Wire loop electrodes	511, 512
		Wire saws	924
		Wire scissors	129
		Wire tighteners	1065
		Wire twisters	1069
		Wire twisters, DUROGRIP	312, 1067, 1068
		Wire twisting forceps	1065, 1073
		Wires, boring	1058, 1059
		cerclage	1065
		<b>WITT</b> , sternal puncture needles	855
		<b>WOLFF</b> , plaster breakers	1087
		Wound hooks	364
		Wound retractors	373
		<b>WRIGLEY</b> , obstetrical forceps	728
		<b>WULLSTEIN</b> , self-retaining retractors	460
		suction cannula	1098-1100
		<b>WÖRRLEIN</b> , reposition tampers	1015



## Y

<b>YANKAUER</b> , suction cannula	885, 1093, 1094
<b>YASARGIL</b> , micro scissors	52
rongeurs	908
suction and irrigation cannula	1104
<b>YEOMAN</b> , biopsy forceps for rectum	580
<b>YOUNG</b> , tongue forceps	16
<b>YOUNG-HRYNTSCHAK</b> , boomerang needle holders	326, 623

## Z

<b>ZAUFAL-JANSEN</b> , bone rongeurs	1032
<b>ZENKER</b> , dissecting and ligature forceps	254
retractors	427
<b>ZIEGLER</b> , head bands	2
head mirrors	2
<b>ZIELKE</b> , gouges for scoliosis operations	1008
<b>ZOELLNER</b> , suction cannula	1098, 1099
<b>ZWEIFEL</b> , DUROGRIP needle holders	323

## Numerischer Index – Numerical Index

55 – BC

Art. Nr. Cat. No.	Seite Page	Art. Nr. Cat. No.	Seite Page	Art. Nr. Cat. No.	Seite Page	Art. Nr. Cat. No.	Seite Page
5518016	23	AC473R	5	BA402R	26	BB080R	41
5518032	22	AC474R	5	BA403R	26	BB084R	41
5518040	22	AC475R	5	BA407R	26	BB085R	41
5518059	22	AC476R	5	BA408R	26	BB087R	41
5518067	23	AC477R	5	BA409R	26	BB088R	41
5518075	23	AC478R	5	BA451R	26	BB089R	41
5518083	23	AC479R	5	BA501R	27	BB175R	39
5518091	23	AC480R	5	BA503R	27	BB176R	39, 618
5518105	22	AC481R	5	BA504R	27	BB177R	39, 618
		AC483C	5	BA506R	27	BB178R	39, 618
16600487	43	AC497R	5	BA507R	27	BB361R	45
16600495	42	AC498R	5	BA508R	27	BB362R	45
16600509	42			BA509R	27	BB363R	45
16600517	42	AD099R	25	BA514R	27	BB364R	45
16600525	42	AD110R	8	BA546R	27	BB365R	45
16600541	43	AD123R	8	BA563R	27	BB366R	45
16600550	43	AD125R	8	BA604R	30	BB367R	45
16600568	43	AD127R	8	BA605R	30	BB368R	45
16600576	43	AD129R	8	BA606R	30	BB369R	45
16600584	43			BA611R	30	BB500	43
16600592	43	AN379R	15	BA641R	31	BB510	42
16615492	42	AN380R	15	BA646R	31	BB511	42
16615514	43	AN381R	15	BA704R	25	BB512	42
16615522	43	AN705R	16	BA705	25	BB513	42
16616634	43	AN706	16	BA706R	34	BB515	42
		AN709R	16, 192, 241	BA708R	34	BB515-1	42
AA804R	7	AN710R	16, 192, 583, 595, 685	BA709R	34	BB515-C	42
AA805R	7	AN711R	16, 192, 583, 596	BA710R	34	BB518	43
AA806R	7	AN908R	17	BA711R	34	BB519	43
AA808R	7	AN909R	17	BA712R	35	BB520	43
AA809	7	AN910R	17	BA713R	35	BB521	43
AA821C	7	AN911R	18	BA714R	35	BB522	43
AA822C	7	AN912R	18	BA715R	35	BB523	43
AA826	7	AN913R	18	BA716R	35	BB524	43
AA845R	8			BA717R	35	BB525	43
AA846R	8	BA210	22	BA718R	35	BB536	43
AA847R	8	BA211	22	BA719R	35	BB540	42, 696
		BA212	22			BB542	42
AC402	2	BA215	22	BB046R	44		
AC413	2	BA218	22	BB048R	44	BC004R	61
AC414	2	BA219	23	BB052R	44	BC005R	61
AC415	2	BA220	23	BB053R	45	BC006R	61
AC416	2	BA221	23	BB054R	44	BC007R	61
AC421	2	BA222	23	BB057R	45	BC008R	62
AC440	3	BA223	23	BB060R	44	BC009R	62
AC461	3	BA224	23	BB068R	38	BC010R	62
AC462	3	BA244R	9	BB070R	40	BC011R	62
AC463	3	BA245R	9	BB071R	40	BC015R	63
AC464	3	BA311SU	24	BB073R	38, 40	BC017R	63
AC468R	5	BA323SU	24	BB074R	38	BC020R	62
AC469R	5	BA364	24	BB075R	38	BC021R	62
AC470R	5	BA365	24	BB077R	39	BC022R	62
AC471R	5	BA367	24	BB078R	40	BC023R	62
AC472R	5	BA401R	26	BB079R	40, 696	BC026R	63



## Numerischer Index – Numerical Index

BC

Art. Nr. Cat. No.	Seite Page	Art. Nr. Cat. No.	Seite Page	Art. Nr. Cat. No.	Seite Page	Art. Nr. Cat. No.	Seite Page
BC027R	63	BC194R	78	BC275R	97	BC345R	74
BC029R	63	BC195R	78	BC275W	102	BC346R	74
BC030R	68	BC210R	92	BC275WB	107	BC374R	75
BC033R	68	BC211R	92	BC276R	97	BC403R	72
BC034R	68	BC211W	101	BC277R	97	BC404R	72
BC050R	67	BC224R	93	BC277W	102	BC411R	73
BC056R	12, 64	BC228R	93	BC279R	97	BC413R	73
BC057R	12, 64	BC231R	93	BC279W	102	BC414R	73
BC060R	64	BC231W	101	BC281R	97	BC415R	73
BC061R	64	BC234R	93	BC281W	102	BC416R	73
BC064R	64	BC242R	94	BC282R	97	BC417R	73
BC065R	64	BC243R	94	BC283B	105	BC421R	71
BC100R	64	BC245R	100, 597	BC283R	95	BC423R	71
BC101R	64	BC250R	94	BC283W	101	BC424R	71
BC106R	65	BC251R	94	BC283WB	107	BC425R	71
BC107R	65	BC252R	94	BC284B	105	BC426R	71
BC110R	65	BC253R	94	BC284R	95	BC427R	71
BC111R	65	BC253W	101	BC284W	101	BC428R	71
BC112R	65	BC256R	95	BC284WB	107	BC441R	74
BC113R	65	BC257B	105	BC285R	97	BC443R	74
BC117R	65	BC257R	95	BC287R	98	BC444R	74
BC130R	66	BC257W	102	BC287W	103	BC445R	74
BC131R	66	BC257WB	106	BC289R	98	BC464R	75
BC135R	66	BC258R	96	BC290R	99	BC474R	75
BC140R	66	BC259B	105	BC290W	103	BC496R	72
BC141R	66	BC259R	96	BC291R	99	BC497R	72
BC144R	66	BC259W	102	BC291W	103	BC503R	75
BC145R	66	BC259WB	106	BC292R	99	BC504R	75
BC153R	67	BC260R	98	BC293R	99	BC506R	75
BC154R	69	BC261B	105	BC294W	104	BC515R	108, 109, 751
BC156R	70	BC261R	98	BC295W	104	BC516R	108, 109, 751
BC157R	70	BC261W	103	BC296W	104	BC517R	108, 109, 751
BC160R	70	BC261WB	107	BC297W	104	BC518R	108, 109, 751
BC161R	70	BC262R	98	BC298W	104	BC519R	108, 109, 751
BC162R	76	BC263B	105	BC299R	99	BC521R	75, 1079
BC163R	76	BC263R	98	BC303R	72	BC522R	108, 109, 751
BC164R	76	BC263W	103	BC304R	72	BC523R	108, 109, 751
BC165R	76	BC263WB	107	BC313R	73	BC524R	108, 109, 751
BC166R	79	BC265B	105	BC314R	73	BC525R	108, 109, 751
BC168R	79	BC265R	98	BC315R	73	BC526R	108, 109, 751
BC170R	78	BC265W	103	BC316R	73	BC531R	108, 109, 751
BC171R	78	BC265WB	107	BC317R	73	BC532R	108, 109, 751
BC172R	78	BC266R	98	BC320R	71	BC533R	108, 109, 751
BC173R	78	BC267R	98	BC321R	71	BC534R	108, 109, 751
BC175R	79	BC267W	103	BC323R	71	BC535R	108, 109, 751
BC177R	79	BC270R	97	BC324R	71	BC544R	82
BC178R	80	BC271B	105	BC325R	71	BC545R	82
BC180R	80	BC271R	97	BC326R	71	BC547R	82
BC181R	80	BC271W	102	BC327R	71	BC551R	100
BC184R	81	BC271WB	107	BC328R	71	BC552R	100
BC186R	78	BC273R	96	BC330R	71	BC554R	82
BC187R	78	BC273W	102	BC341R	74	BC555R	82
BC188R	81	BC274R	97	BC343R	74	BC557R	82
BC189R	81	BC275B	105	BC344R	74	BC558R	94

## Numerischer Index – Numerical Index

### BC – BD

Art. Nr. Cat. No.	Seite Page	Art. Nr. Cat. No.	Seite Page	Art. Nr. Cat. No.	Seite Page	Art. Nr. Cat. No.	Seite Page
BC559R	94	BC628R	79	BC760R	119	BC980R	132, 1082
BC560R	84	BC629R	80	BC761R	119	BC981R	132, 1082
BC561R	84	BC630R	80	BC762R	120	BC983R	132, 1082
BC562R	83	BC631R	80	BC763R	120, 693	BC985R	132, 1082
BC563R	83	BC633R	81	BC764R	121, 692	BC987R	132, 1082
BC564R	83	BC634R	81	BC765R	120, 693	BC988R	132
BC565R	83	BC635R	81	BC766R	121, 692	BC989R	132
BC566R	84	BC636R	114	BC771R	122		
BC569R	84	BC640R	115	BC772R	122	BD023R	156
BC570R	82	BC641R	115	BC774R	122	BD025R	156
BC572R	82	BC642R	112, 596	BC776R	122	BD027R	156
BC573R	82	BC643R	114	BC796R	123, 723	BD029R	156
BC575R	82	BC644R	112	BC797R	123, 723	BD030R	156
BC576R	83	BC645R	113	BC801R	128	BD031R	156
BC577R	83	BC646R	111	BC802R	128	BD032R	156
BC578R	83	BC647R	110	BC803R	128	BD033R	156
BC579R	83	BC648R	110	BC805R	128	BD035R	157
BC580R	85	BC649R	110	BC815R	129, 1073	BD037R	157
BC581R	85	BC650R	111, 597	BC835R	131	BD043R	156
BC584R	86	BC651R	111, 597	BC838R	131	BD045R	156
BC585R	86	BC652R	111	BC846R	131	BD047R	156
BC587R	86	BC653R	110	BC847R	131	BD049R	156
BC588R	86	BC654R	110	BC848R	133	BD050R	156
BC589R	86	BC656R	110	BC849R	133	BD051R	156
BC590R	85	BC657R	110	BC860R	133	BD052R	156
BC591R	85	BC658R	114	BC861R	133	BD053R	156
BC592R	85	BC659R	114	BC862R	133	BD065R	157
BC595R	89	BC660R	112	BC863R	133	BD067R	157
BC597R	114	BC662R	110	BC876R	133	BD068R	157
BC600R	87	BC663R	110	BC881R	132, 1082	BD069R	157
BC601R	87	BC664R	110	BC885R	132, 1082	BD077R	157
BC602R	87	BC669R	111	BC888R	134	BD078R	158
BC603R	87	BC670R	111	BC890R	132	BD081R	155
BC604R	87	BC672R	81	BC900R	90	BD083R	158
BC605R	87	BC680R	87	BC901R	90	BD130R	158
BC606R	87	BC683R	87	BC911R	90	BD151R	162
BC607R	87	BC685R	530	BC915R	90	BD154R	162
BC608R	515	BC686R	530	BC916R	90	BD156R	162
BC611R	88	BC687R	530	BC917R	90	BD157R	162
BC612R	88	BC688R	530	BC920R	90	BD158R	162
BC613R	88	BC689R	530	BC921R	90	BD159R	162
BC614R	88	BC690R	530	BC924R	91	BD160R	164
BC615R	88	BC702R	118	BC925R	91	BD164R	164
BC616R	88	BC703R	118	BC930R	91	BD165R	164
BC617R	126, 565	BC704R	118	BC931R	91	BD166R	164
BC618R	88	BC708R	118	BC934R	91	BD168R	164
BC619R	88	BC715R	113, 618	BC935R-BC937R	91	BD171R	163, 543
BC620R	89	BC721R	117	BC970R	132, 1082	BD173R	163, 543
BC621R	125, 565	BC723R	117	BC971R	132, 1082	BD180R	163
BC622R	126, 565	BC731R	118	BC973R	132, 1082	BD181R	163
BC623R	126, 565	BC741R	117	BC975R	132, 1082	BD185R	178
BC624R	125	BC743R	117	BC977R	132, 1082	BD190R	149, 757
BC625R	88	BC746R	117	BC978R	132	BD191R	149, 757
BC627R	127, 567	BC748R	117	BC979R	132	BD192R	149, 757





## Numerischer Index – Numerical Index

BD – BF

Art. Nr. Cat. No.	Seite Page	Art. Nr. Cat. No.	Seite Page	Art. Nr. Cat. No.	Seite Page	Art. Nr. Cat. No.	Seite Page
BD193R.....	149, 757	BD336R.....	139	BD602R.....	176	BD878R.....	165
BD194R.....	149, 757	BD337R.....	139	BD603R.....	176	BD879R.....	165
BD195R.....	149, 757	BD338R.....	139	BD604R.....	176	BD880R.....	165
BD196R.....	149, 757	BD340R.....	140	BD606R.....	176	BD883R.....	166
BD197R.....	149, 757	BD343R.....	138	BD607R.....	176	BD885R.....	166
BD198R.....	164	BD345R.....	138	BD608R.....	177	BD886R.....	166
BD210R.....	153	BD500R.....	171	BD609R.....	177	BD887R.....	166
BD213R.....	154	BD501R.....	171	BD610R.....	177	BD888R.....	166
BD215R.....	154	BD502R.....	171	BD611R.....	177	BD900R.....	167
BD216R.....	154	BD505R.....	139	BD651R.....	173	BD902R.....	167
BD217R.....	154	BD506R.....	169	BD660R.....	172	BD903R.....	167
BD220R.....	151	BD507R.....	169	BD661R.....	172	BD904R.....	167
BD222R.....	151	BD508R.....	169	BD662R.....	172	BD905R.....	167
BD223R.....	152	BD509R.....	168	BD663R.....	172	BD910R.....	167
BD224R.....	152	BD510R.....	168	BD664R.....	172	BD911R.....	167
BD225R.....	151	BD511R.....	168	BD665R.....	171	BD952R.....	181
BD226R.....	152	BD512R.....	168	BD666R.....	171	BD963R.....	181
BD228R.....	154	BD513R.....	169	BD667R.....	171	BD964R.....	181
BD229R.....	154	BD520R.....	169	BD668R.....	171	BD965R.....	181
BD230R.....	154	BD521R.....	169	BD669R.....	171	BD980R.....	181
BD231R.....	155	BD522R.....	169	BD670R.....	172	BD992R.....	181
BD232R.....	155	BD523R.....	169	BD671R.....	172	BD993R.....	181
BD236R.....	154	BD527R.....	174	BD672R.....	172	BD995R.....	181
BD238R.....	155	BD533R.....	174	BD678R.....	173		
BD239R.....	155	BD535R.....	174	BD679R.....	172	BF003R.....	184
BD240R.....	155	BD537R.....	174	BD690R.....	178	BF004R.....	184
BD243R.....	155	BD539R.....	174	BD692R.....	178	BF006R.....	184
BD246R.....	155	BD540R.....	174	BD693R.....	177	BF008R.....	184
BD247R.....	155	BD541R.....	174	BD700R.....	170	BF010R.....	184
BD250R.....	155, 783	BD542R.....	174	BD701R.....	170	BF016R.....	184
BD257R.....	155	BD543R.....	174	BD702R.....	170	BF021R.....	184
BD260R.....	140	BD547R.....	175	BD704R.....	177	BF027R.....	185
BD261R.....	140	BD549R.....	175	BD705R.....	178	BF032R.....	185
BD264R.....	140	BD552R.....	174	BD725R.....	179, 543	BF033R.....	185
BD268R.....	154	BD553R.....	174	BD726R.....	179, 543	BF040R.....	185
BD269R.....	154	BD555R.....	174	BD727R.....	179, 543	BF041R.....	185
BD301R.....	153	BD557R.....	174	BD735R.....	179	BF046R.....	10, 185
BD302R.....	153	BD559R.....	174	BD736R.....	179	BF047R.....	10, 185
BD303R.....	153	BD560R.....	174	BD750R.....	179	BF056R.....	187
BD304R.....	153	BD561R.....	174	BD755R.....	179	BF057R.....	187
BD305R.....	153	BD562R.....	174	BD760R.....	179	BF058R.....	187
BD311R.....	153	BD563R.....	174	BD801R.....	180, 838	BF059R.....	187
BD312R.....	153	BD564R.....	174	BD802R.....	180, 838	BF060R.....	10, 186
BD313R.....	153	BD575R.....	175	BD820R.....	180, 543	BF061R.....	10, 186
BD314R.....	153	BD577R.....	175	BD852R.....	519	BF062R.....	186
BD315R.....	153	BD579R.....	175	BD853R.....	519	BF063R.....	186
BD320R.....	153	BD580R.....	175	BD854R.....	519	BF065R.....	186
BD321R.....	153	BD581R.....	175	BD855R.....	519	BF070R.....	188
BD322R.....	153	BD587R.....	176	BD856R.....	519	BF071R.....	188
BD329R.....	138	BD589R.....	176	BD857R.....	519	BF076R.....	188
BD330R.....	138	BD591R.....	176	BD858R.....	519	BF077R.....	188
BD331R.....	138	BD597R.....	176	BD859R.....	519	BF078R.....	188
BD333R.....	138	BD598R.....	176	BD860R.....	519	BF091R.....	189
BD335R.....	138	BD600R.....	175	BD870R.....	165	BF092R.....	189

## Numerischer Index – Numerical Index

BF – BH

Art. Nr. Cat. No.	Seite Page	Art. Nr. Cat. No.	Seite Page	Art. Nr. Cat. No.	Seite Page	Art. Nr. Cat. No.	Seite Page
BF098R	189	BF466R	205	BH154R	222	BH316R	231
BF112R	190	BF491R	207	BH155R	222	BH318R	231
BF113R	190	BF493R	207	BH160R	223	BH332R	232
BF116R	190	BF494R	207	BH161R	223	BH333R	232
BF118R	190			BH164R	224	BH334R	232
BF120R	190	BH011R	216, 786	BH165R	224	BH335R	232
BF121R	190	BH012R	216, 786	BH166R	224	BH336R	232
BF122R	190, 594	BH013R	216, 786	BH167R	224	BH337R	232
BF123R	190, 594	BH014R	216, 786	BH168R	225	BH338R	232
BF135R	193, 685, 734	BH015R	216, 786	BH170R	223	BH339R	232
BF136R	193	BH016R	216, 786	BH171R	223	BH353R	520
BF299R	196	BH017R	216, 786	BH176R	224	BH354R	520
BF300R	196, 538	BH018R	216, 786	BH177R	224	BH361R	232
BF301R	196, 538	BH020R	216, 786	BH178R	225	BH410R	17, 231
BF303R	194	BH021R	216, 786	BH183R	226	BH412R	232
BF306R	194	BH022R	216, 786	BH187R	226	BH413R	232
BF307R	194	BH023R	216, 786	BH191R	227	BH414R	232
BF309R	197, 678	BH026R	216, 786	BH193R	227	BH415R	232
BF310R	197, 678	BH027R	216, 786	BH196R	228	BH422R	232
BF311R	197, 678	BH030R	217, 787	BH197R	228	BH424R	232
BF315R	195	BH031R	217, 787	BH198R	225	BH425R	232
BF316R	195	BH032R	217, 787	BH199R	225, 245	BH442R	233
BF320R	195	BH034R	217, 787	BH200R	225	BH443R	233
BF324R	195	BH100R	220	BH201R	225	BH444R	233
BF325R	195	BH104R	220	BH202R	225	BH445R	233
BF326R	195	BH105R	220	BH203R	225	BH446R	233
BF401R	201	BH106R	221	BH205R	226	BH447R	233
BF407R	201	BH108R	220	BH206R	227	BH448R	233
BF408R	201	BH109R	220	BH207R	227	BH449R	233
BF410R	201	BH110R	220	BH209R	227, 250	BH450R	233
BF411R	201	BH111R	220	BH210R	226	BH451R	233
BF417R	202	BH114R	220	BH211R	226	BH456R	233
BF426R	203, 674	BH115R	220	BH212R	225	BH457R	233
BF431R	203	BH118R	220	BH213R	225	BH470R	234
BF432R	203	BH119R	220	BH214R	226	BH471R	234
BF433R	203	BH120R	220	BH215R	226	BH472R	234
BF436R	203	BH121R	220	BH216R	227	BH473R	234
BF437R	203	BH123R	222	BH217R	227	BH474R	234
BF439R	204	BH124R	223	BH224R	229	BH475R	234
BF440R	204	BH125R	223	BH225R	229	BH610R	235
BF442R	204	BH126R	223	BH226R	238	BH612R	235
BF443R	204	BH127R	223	BH227R	230	BH614R	235
BF444R	203	BH130R	221	BH228R	228	BH615R	235
BF448R	203	BH131R	221	BH229R	228	BH618R	235
BF450R	202, 543	BH134R	221	BH230R	230	BH619R	235
BF451R	202, 543	BH135R	221	BH231R	230	BH630R	235
BF452R	202, 543	BH139R	221	BH234R	229	BH631R	235
BF458R	206	BH140R	222	BH238R	228	BH642R	236
BF459R	206	BH141R	222	BH239R	228	BH643R	236
BF460R	205	BH143R	221	BH243R	520	BH644R	236
BF461R	205	BH144R	222	BH300R	231	BH645R	236
BF463R	205	BH145R	222	BH302R	231	BH646R	236
BF464R	205	BH150R	222	BH304R	231	BH647R	236
BF465R	205	BH151R	222	BH312R	231	BH648R	236



## Numerischer Index – Numerical Index

BH – BL

Art. Nr. Cat. No.	Seite Page	Art. Nr. Cat. No.	Seite Page	Art. Nr. Cat. No.	Seite Page	Art. Nr. Cat. No.	Seite Page
BH649R	236	BJ024R	246	BJ131R	254	BJ582R	269
BH650R	236	BJ025R	246	BJ132R	254	BJ583R	269
BH651R	236	BJ026R	246	BJ300R	257	BJ584R	269
BH652R	236	BJ029R	252, 619	BJ304R	257	BJ585R	269
BH653R	236	BJ031R	246	BJ305R	257		
BH654R	236	BJ032R	246	BJ306R	257	BL058N	276
BH655R	236	BJ033R	246	BJ308R	257	BL059N	276
BH658R	236	BJ034R	246	BJ309R	258	BL060N	276
BH659R	236	BJ035R	246	BJ310R	258	BL061N	276
BH686R	531	BJ041R	251	BJ312R	258	BL062N	276
BH687R	531	BJ042R	251	BJ313R	259	BL063N	276
BH689R	531	BJ043R	251	BJ314R	259	BL064N	276
BH800R	237	BJ044R	251	BJ315R	259	BL065N	276
BH801R	237	BJ045R	251	BJ325R	260	BL066N	276
BH804R	237	BJ047R	254	BJ326R	260	BL067N	276
BH805R	237	BJ048R	254	BJ500R	260	BL068N	276
BH807R	237	BJ050R	249	BJ501R	260	BL069N	276
BH808R	237	BJ051R	250, 840	BJ506R	263	BL070N	276
BH812R	238	BJ052R	251, 840	BJ507R	263	BL071N	276
BH813R	238	BJ055R	253, 593, 841	BJ509R	264	BL072N	276
BH814R	238	BJ057R	252	BJ510R	265	BL073N	276
BH831R	239, 592	BJ058R	252	BJ511R	265	BL074N	276
BH833R	239, 592	BJ059R	252	BJ515R	264	BL075N	276
BH835R	239, 609	BJ060R	255, 590	BJ517R	260	BL076N	276
BH837R	239, 609	BJ061R	255, 841	BJ519R	260	BL098N	276
BH839R	239, 609	BJ062R	255, 841	BJ520R	261	BL099N	276
BH902R	241, 542	BJ067R	249	BJ521R	261	BL100N	276
BH906R	16, 192, 241	BJ068R	255	BJ522R	261	BL101N	276
BH908R	192, 241	BJ070R	253	BJ524R	261	BL102N	276
BH949R	240	BJ073R	255, 841	BJ526R	262	BL103N	276
BH951R	240	BJ075R	254, 691	BJ527R	262	BL104N	276
BH952R	240	BJ076R	254, 691	BJ528R	265	BL105N	276
BH957R	240	BJ080R	247	BJ529R	261	BL106N	276
BH959R	240	BJ081R	247	BJ530R	267	BL107N	276
BH961R	240	BJ082R	247	BJ531R	267	BL108N	276
BH963R	240	BJ083R	247	BJ532R	267	BL109N	276
BH965R	240	BJ086R	247	BJ534R	266	BL110N	276
		BJ090R	247	BJ535R	266	BL111N	276
BJ002R	244	BJ091R	247	BJ536R	260	BL112N	276
BJ008R	244	BJ096R	247	BJ537R	266	BL113N	276
BJ009R	244	BJ100R	248	BJ540R	264	BL114N	276
BJ011R	244	BJ102R	248	BJ541R	265	BL115N	276
BJ012R	244	BJ103R	248	BJ550R	268	BL116N	276
BJ013R	245	BJ104R	248	BJ551R	100, 268	BL161N	276
BJ014R	245	BJ106R	248	BJ552R	100, 268	BL162N	276
BJ015R	245	BJ110R	252, 619	BJ553R	268	BL163N	276
BJ016R	245	BJ111R	247	BJ560R	271, 692	BL164N	276
BJ017R	245	BJ114R	247	BJ561R	271, 693	BL165N	276
BJ018R	245	BJ120R	252	BJ562R	271, 692	BL166N	276
BJ019R	246	BJ121R	252	BJ563R	271, 693	BL167N	276
BJ020R	246	BJ122R	252	BJ574R	270, 611	BL168N	276
BJ021R	246	BJ123R	252	BJ576R	270	BL169N	276
BJ022R	246	BJ124R	252	BJ579R	273, 612	BL170N	276
BJ023R	246	BJ130R	254	BJ581R	272, 612, 808	BL171N	276

## Numerischer Index – Numerical Index

BL – BM

Art. Nr. Cat. No.	Seite Page	Art. Nr. Cat. No.	Seite Page	Art. Nr. Cat. No.	Seite Page	Art. Nr. Cat. No.	Seite Page
BL172N	276	BL546N	278	BM035R	313, 776	BM150R	325
BL173N	276	BL547N	278	BM036R	313, 776	BM151R	325
BL174N	276	BL548N	278	BM037R	313, 776	BM153R	325
BL175N	276	BL601N	278	BM038R	313, 776	BM154R	325
BL176N	276	BL602N	278	BM040R	314, 777	BM156R	325
BL201N	276	BL603N	278	BM042R	316	BM158R	325
BL202N	276	BL604N	278	BM044R	320, 779	BM165R	324
BL203N	276	BL605N	278	BM045R	320, 779	BM168R	324
BL204N	276	BL611N	278	BM046R	320, 779	BM170R	323
BL205N	276	BL612N	278	BM047R	320, 779	BM172R	323
BL206N	276	BL613N	278	BM051R	314, 777	BM178R	323
BL207N	276	BL614N	278	BM052R	314, 777	BM183R	322
BL208N	276	BL615N	278	BM054R	320, 779	BM184R	319, 778
BL209N	276	BL907R	279	BM055R	320, 779	BM186R	322
BL210N	276	BL910R	279	BM056R	320, 779	BM191R	322
BL211N	276	BL911R	279	BM057R	320, 779	BM193R	322
BL212N	276	BL915R	279	BM058R	320, 779	BM196R	322
BL213N	276	BL929R	279	BM063R	313, 776	BM200R	299
BL214N	276	BL930R	279	BM064R	313, 776	BM201R	299
BL215N	276	BL931R	279	BM065R	310	BM202R	299
BL216N	276	BL932R	279	BM066R	310	BM204R	299
BL231N	277	BL933R	279	BM067R	310	BM205R	299
BL232N	277	BL941R	279	BM068R	310	BM210R	299
BL233N	277	BL943R	279	BM069R	310	BM211R	300
BL234N	277			BM070R	310	BM215R	299
BL235N	277	BM001R	286, 773	BM074R	319, 778	BM218R	300
BL236N	277	BM002R	286, 773	BM075R	319, 778	BM219R	300
BL237N	277	BM003R	286, 773	BM076R	319, 778	BM220R	300
BL251N	277	BM004R	287, 774	BM077R	310	BM221R	301
BL252N	277	BM005R	287, 774	BM078R	310	BM224R	301
BL253N	277	BM008R	307	BM081R	315	BM235R	301
BL254N	277	BM009R	307	BM082R	315	BM236R	301
BL255N	277	BM010R	307	BM084R	315	BM237R	301
BL256N	277	BM011R	307	BM088R	317	BM238R	301
BL257N	277	BM012R	308	BM089R	317, 568	BM240R	301
BL301N	277	BM013R	309	BM090R	318	BM241R	302
BL302N	277	BM014R	308	BM092R	318	BM242R	302
BL303N	277	BM015R	308	BM095R	315	BM245R	302
BL305N	277	BM016R	309	BM096R	315	BM247R	302
BL318N	277	BM017R	309	BM100R	315	BM249R	302
BL319N	277	BM018R	308	BM101R	315	BM255R	302
BL320N	277	BM019R	309	BM102R	315	BM259R	302
BL321N	277	BM020R	309	BM105R	316	BM270R	302
BL322N	277	BM021R	309	BM110R	312, 1067	BM272R	303
BL323N	277	BM022R	309	BM111R	312, 1067	BM275R	303
BL324N	277	BM023R	309	BM112R	312, 1067	BM280R	303
BL325N	277	BM024R	308	BM113R	312, 1068	BM290R	304
BL539N	278	BM025R	313, 776	BM124R	311	BM291R	304
BL540N	278	BM026R	313, 776	BM127R	311	BM298R	304
BL541N	278	BM027R	313, 776	BM128R	311	BM299R	304
BL542N	278	BM030R	309	BM129R	311	BM301R	298, 767
BL543N	278	BM032R	313, 776	BM132R	324	BM302R	298, 767
BL544N	278	BM033R	313, 776	BM148R	325	BM310R	321, 775
BL545N	278	BM034R	313, 776	BM149R	325	BM311R	321, 775



## Numerischer Index – Numerical Index

BM – BT

Art. Nr. Cat. No.	Seite Page	Art. Nr. Cat. No.	Seite Page	Art. Nr. Cat. No.	Seite Page	Art. Nr. Cat. No.	Seite Page
BM320R	321, 775	BM856R	334	BN120R	345	BN925R	353
BM325R	298, 767	BM858R	335	BN125R	345	BN926R	353
BM327R	298, 767	BM861R	335, 1056	BN134R	345	BN942R	353
BM328R	298, 767	BM900R	337	BN136R	345	BN943R	353
BM360R	305	BM901R	337	BN138R	345	BN944R	353
BM361R	305	BM902R	337	BN140R	345	BN945R	353
BM362R	305	BM905R	337	BN150R	345	BN946R	353
BM406R	305	BM911R	337	BN160	347	BN947R	353
BM407R	305	BM913R	337	BN161	347		
BM503R	305	BM920R	337	BN170R	347	BT001R	378
BM510R	305	BM922R	337	BN172R	347	BT004R	379
BM560R	283, 771	BM924R	338	BN184R	348	BT005R	377
BM562R	283, 771	BM925R	338	BN400R	349	BT006R	377
BM563R	282, 770	BM931R	336	BN403	349	BT007R	377
BM564R	282, 770	BM932R	336	BN404	349	BT008R	377
BM620R	326, 623	BM938	338	BN440R	349	BT010R	379
BM627R	326, 623	BM940	338	BN445R	349	BT011R	379
BM628R	326, 623	BM941	338	BN452R	351	BT012R	379
BM629R	326, 623	BM950R	339	BN457R	351	BT019R	379
BM711R	327	BM976R	691	BN460R	350	BT020R	379
BM712R	327	BM977R	691	BN461R	350	BT021R	379
BM713R	327			BN465R	350	BT022R	380
BM714R	327	BN003R	342	BN466R	350	BT025R	379
BM726R	328	BN004R	342	BN467R	349	BT026R	380
BM727R	328	BN006R	342	BN468R	350	BT028R	382
BM728R	328	BN010R	342	BN507R	352	BT029R	382
BM729R	328	BN012R	342	BN511R	352	BT030R	381
BM748R	333	BN015R	342	BN512R	352	BT031R	381
BM749R	333	BN020R	342, 579	BN515R	352	BT032R	381
BM755R	333	BN021R	343, 579	BN516R	352	BT033R	381
BM770R	332	BN022R	343, 579	BN518R	352	BT034R	383
BM771R	332	BN023R	343, 579	BN520R	352	BT035R	383
BM774R	333	BN024R	343, 579	BN522R	352	BT036R	383
BM780R	332	BN026R	343, 579	BN730R	352	BT037R	384
BM781R	332	BN034R	344, 1048	BN731R	352	BT038R	384
BM801R	329	BN036R	344, 1048	BN750R	352	BT040R	385
BM802R	329	BN040R	344, 1048	BN754R	352	BT041R	386
BM806R	330	BN054R	344	BN757R	352	BT042R	384
BM807R	330	BN063R	344	BN758R	352	BT047R	386
BM808R	330	BN064R	344	BN902R	353	BT048R	386
BM809R	330	BN066R	344	BN903R	353	BT049R	386
BM810R	331	BN068R	344	BN904R	353	BT075R	357
BM811R	331	BN070R	344	BN905R	353	BT080R	357
BM812R	329	BN090R	345, 579	BN906R	353	BT082R	357
BM813R	329	BN095	346	BN907R	353	BT083R	357
BM814R	329	BN096	346	BN912R	353	BT084R	359
BM822R	331	BN099	346	BN913R	353	BT088R	359
BM823R	331	BN101R	346	BN914R	353	BT089R	359
BM824R	331	BN104R	345	BN915R	353	BT090R	359
BM825R	331	BN110	345	BN916R	353	BT091R	359
BM831R	336, 1056	BN113R	345	BN917R	353	BT100R	364
BM832R	336	BN114R	345	BN922R	353	BT103R	364
BM853R	334	BN116R	345	BN923R	353	BT106R	364
BM855R	334	BN118R	345	BN924R	353	BT107R	364

## Numerischer Index – Numerical Index

BT

Art. Nr. Cat. No.	Seite Page	Art. Nr. Cat. No.	Seite Page	Art. Nr. Cat. No.	Seite Page	Art. Nr. Cat. No.	Seite Page
BT111R	365	BT223R	388	BT322R	395	BT462R	409
BT112R	365	BT224R	388	BT323R	395	BT463R	409
BT113R	365	BT225R	388	BT325R	395	BT464R	407
BT114R	365	BT227R	388	BT326R	395	BT465R	408
BT116R	365	BT228R	388	BT327R	397	BT470R	413
BT117R	365	BT229R	388	BT328R	397	BT471R	413
BT118R	365	BT230R	388	BT329R	415	BT472R	413
BT119R	365	BT232R	387	BT330R	415	BT475R	413
BT121R	366	BT234R	387	BT331R	415	BT476R	413
BT122R	366	BT238R	387	BT332R	398	BT477R	413
BT123R	366	BT239R	387	BT340R	397	BT478R	414
BT124R	366	BT240R	387	BT343R	398	BT479R	414
BT126R	366, 625	BT241R	387	BT351R	404	BT481R	415
BT127R	366	BT242R	389	BT352R	404	BT482R	415
BT128R	366	BT243R	389	BT353R	404	BT483R	415
BT129R	366	BT244R	389	BT354R	396	BT484R	415
BT132R	365	BT246R	389	BT356R	396	BT485R	416
BT133R	365	BT248R	389	BT357R	396	BT486R	416
BT134R	365	BT252R	389	BT358R	396	BT487R	416
BT136R	365	BT253R	389	BT359R	396	BT490R	410
BT137R	365	BT254R	389	BT361R	396	BT492R	410
BT138R	365	BT256R	389	BT363R	396	BT494R	410
BT161R	372	BT257R	389	BT364R	396	BT498R	410
BT166R	372	BT258R	389	BT365R	396	BT500R	443
BT167R	372	BT259R	389	BT369R	403	BT501R	946
BT170R	373	BT260R	389	BT370R	403	BT502R	946
BT171R	373	BT261R	389	BT371R	403	BT503R	946
BT172R	373	BT262R	390	BT372R	403	BT504R	946
BT173R	370	BT263R	390	BT373R	403	BT505R	946
BT174R	370	BT264R	390	BT400R	405	BT508R	418
BT177R	370	BT265R	389	BT404R	406	BT509R	418
BT178R	370	BT266R	390	BT405R	406	BT510R	418
BT179R	370	BT272R	390	BT406R	406	BT511R	418
BT180R	373	BT273R	390	BT408R	406	BT512R	418
BT181R	373	BT274R	390	BT419R	400, 1045	BT513R	418
BT182R	374	BT276R	390	BT420R	400, 1045	BT514R	425
BT183R	374	BT278R	392	BT421R	399, 1045	BT521R	425
BT184R	375	BT279R	392	BT422R	399, 1045	BT522R	425
BT185R	375	BT280R	392	BT423R	399, 1045	BT523R	425
BT187R	375	BT284R	393	BT424R	399, 1045	BT524R	419
BT190R	374	BT285R	393	BT425R	399, 1045	BT525R	419
BT192R	375	BT286R	393	BT430R	400, 1045	BT526R	419
BT193R	371	BT287R	393	BT440R	411	BT527R	419
BT194R	371	BT288R	394	BT441R	411	BT528R	419
BT195R	371	BT290R	392	BT442R	411	BT529R	419
BT196R	371	BT293R	391	BT443R	411	BT530R	419
BT197R	371	BT294R	391	BT444R	411	BT531R	426, 880
BT198R	371	BT295R	391	BT445R	411	BT540P	412
BT200R	376	BT296R	391	BT446R	411, 569	BT542P	412
BT201R	376	BT311R	394	BT457R	374	BT545P	412
BT202R	376	BT315R	394	BT458R	374	BT551R	422, 878
BT206R	376	BT316R	394	BT459R	409	BT552R	422, 878
BT221R	388	BT320R	395	BT460R	409	BT553R	423, 879
BT222R	388	BT321R	395	BT461R	409	BT559R	424, 881



## Numerischer Index – Numerical Index

BT – BV

Art. Nr. Cat. No.	Seite Page	Art. Nr. Cat. No.	Seite Page	Art. Nr. Cat. No.	Seite Page	Art. Nr. Cat. No.	Seite Page
BT560R	424, 881	BT732R	435	BT916R	367	BV086R	472
BT561R	424, 881	BT740R	436	BT917R	367	BV087R	472, 659
BT594R	427	BT742R	436	BT918R	367	BV088R	464
BT595R	427	BT746R	451	BT921R	367	BV090R	462
BT596R	427	BT747R	451	BT922R	367	BV091R	462
BT597R	427	BT749R	450	BT923R	367	BV092R	464
BT600R	429	BT750R	450	BT926R	367	BV093R	464
BT601R	429	BT751R	450	BT927R	367	BV094R	463
BT602R	430	BT752R	450	BT928R	367	BV097R	461
BT603R	430	BT755R	450	BT933R	368	BV098R	461
BT604R	431	BT756R	450	BT940R	368	BV099R	461
BT605R	432	BT758R	450	BT943R	368	BV101R	460
BT606R	429	BT761R	450	BT944R	368	BV104R	460
BT607R	431	BT762R	450	BT945R	368	BV112R	465
BT608R	432	BT763R	450	BT946R	368	BV113R	465
BT611R	433	BT773R	451	BT948R	369	BV199R	466
BT613R	433	BT774R	451	BT949R	369	BV200R	466
BT614R	434	BT775R	451	BT951R	369	BV201R	466
BT615R	434	BT776R	451	BT958R	369	BV203R	466
BT617R	443	BT777R	451	BT964R	369	BV205R	466
BT618R	437	BT780R	453	BT966R	369	BV206R	466
BT621R	437	BT795R	453			BV207R	466
BT622R	438	BT799R	421	BV001R	456	BV208R	466
BT623R	438	BT800R	421	BV002R	456	BV209R	466
BT624R	438	BT801R	420	BV003R	456	BV247R	467
BT626R	442	BT802R	420	BV005R	456	BV248R	468
BT630R	439	BT803R	420	BV006R	456	BV249R	467
BT633R	439	BT804R	420	BV007R	456	BV250R	468
BT655R	445	BT805R	420	BV008R	457	BV252R	468
BT656R	445	BT806R	420	BV010R	457	BV254R	469
BT657R	445	BT807R	420	BV011R	457	BV255R	469
BT658R	445	BT808R	420	BV013R	457	BV258R	470
BT659R	445	BT809R	420	BV014R	457	BV260R	469
BT667R	446	BT810R	420	BV015R	457	BV271R	470
BT669R	446	BT811R	420	BV028R	458	BV272R	470
BT670R	440, 578	BT812R	420	BV030R	458	BV273R	471
BT672R	440, 578	BT813R	420	BV032R	458	BV276R	471
BT674R	441, 578	BT814R	420	BV033R	458	BV296R	481
BT680R	452, 620	BT815R	420	BV059R	768	BV297R	481
BT681R	452, 620	BT816R	420	BV066R	459	BV298R	481
BT703R	447	BT817R	420	BV067R	459	BV299R	481
BT708R	449	BT818R	420	BV068R	461	BV326R	482
BT709R	449	BT819R	420	BV070R	459	BV327R	482, 497
BT710R	448	BT820R	420	BV071R	459	BV328R	482
BT711R	448	BT821R	420	BV072R	461	BV329R	482
BT712R	448	BT822R	420	BV073R	459	BV338R	482
BT713R	448	BT901R	367	BV074R	459	BV348R	497
BT714R	448	BT902R	367	BV075R	461	BV349R	497
BT715R	448	BT904R	367	BV076R	460	BV361R	482
BT721R	447	BT906R	367	BV077R	460	BV362R	482
BT723R	447	BT908R	367	BV078R	462	BV363R	482
BT724R	447	BT911R	367	BV079R	462	BV366R	483
BT725R	447	BT912R	367	BV084R	463	BV367R	483
BT730R	435	BT913R	367	BV085R	463	BV369R	483

## Numerischer Index – Numerical Index

BV – DO

Art. Nr. Cat. No.	Seite Page	Art. Nr. Cat. No.	Seite Page	Art. Nr. Cat. No.	Seite Page	Art. Nr. Cat. No.	Seite Page
BV379R	480	BV505R	485	BV616R	487	BV697R	492, 493
BV380R	480	BV506R	485	BV617R	487	BV698R	492, 493
BV381R	480	BV509R	477	BV618R	487	BV709R	475
BV382R	480	BV510R	477	BV621R	488	BV710R	475
BV383R	480	BV512R	485, 866	BV622R	488	BV711R	475
BV384R	480	BV516R	477	BV624R	488	BV712T	475
BV385R	480	BV517R	477	BV626R	488	BV713T	475
BV391R	480	BV518R	477	BV628R	488	BV906R	573
BV392R	480	BV519R	477	BV632R	488	BV907R	577
BV393R	480	BV520R	482	BV634R	488	BV927R	621
BV394R	480	BV522R	482	BV636R	488	BV928R	496, 617
BV395R	480	BV523R	482	BV638R	488	BV993R	472
BV400R	476	BV524R	482	BV640R	488	BV996R	473, 659
BV401R	476	BV527R	483	BV645R	490	BV997R	473, 659
BV403R	476	BV528R	483	BV646R	490	BV998R	473
BV405R	476	BV530R	482	BV647R	490	BV999R	473
BV406R	476	BV531R	482	BV648R	490		
BV409R	476	BV532R	482	BV649R	490	DF112R	993
BV411R	476	BV533R	482	BV650R	490	DF114R	993
BV413R	479	BV535R	482	BV653R	491		
BV414R	479	BV536R	482	BV654R	491	DO208R	92
BV415R	479	BV542R	483	BV655R	491	DO209R	92
BV416R	479	BV543R	483	BV656R	491	DO210R	65
BV417R	479	BV545R	483	BV657R	491	DO211R	65
BV435R	478	BV551R	482, 484	BV658R	491	DO218R	67
BV437R	478	BV552R	482, 484	BV659R	491	DO219R	69
BV441R	478	BV553R	482, 484	BV660R	494	DO250R	92
BV442R	478	BV554R	482, 484	BV661R	494	DO251R	69
BV443R	478	BV555R	482, 484	BV662R	494	DO252R	69
BV444R	478	BV556R	483, 484	BV663R	494	DO432R	407
BV445R	478	BV557R	483, 484	BV664R	494	DO438R	408
BV446R	478	BV558R	483, 484	BV665R	494	DO439R	408
BV447R	478	BV575R	496, 617	BV668R	494	DO440R	405
BV448R	478	BV576R	496, 617	BV669R	494	DO441R	405
BV449R	478, 479	BV577R	496, 617	BV670R	495	DO450R	401
BV450R	478	BV578R	496, 617	BV672R	495	DO451R	401
BV451R	478	BV580R	496, 617	BV674R	495	DO452R	401
BV452R	478	BV581R	576	BV675R	495	DO453R	401
BV453R	478	BV582R	576	BV676R	495	DO454R	401
BV454R	478	BV583R	576	BV680R	495	DO455R	401
BV455R	478	BV584R	576	BV682R	495	DO460R	402
BV456R	478	BV585R	576	BV684R	495	DO461R	402
BV457R	478	BV586R	576	BV685	492	DO462R	402
BV458R	478	BV589R	576	BV686R	492	DO463R	402
BV461R	478	BV591R	576	BV687R	492	DO464R	402
BV462R	478	BV601R	485	BV688R	492	DO465R	402
BV463R	478	BV602R	485	BV689R	492	DO510R	961
BV464R	478	BV605R	486	BV690R	492, 493	DO518R	972
BV465R	478	BV606R	486, 488	BV691R	492, 493	DO520R	966
BV466R	478	BV608R	486	BV692R	492, 493	DO523R	969
BV467R	478	BV609R	486, 488	BV693R	492, 493	DO543R	966
BV468R	478	BV610R	486	BV694R	492, 493	DO546R	961
BV500R	485	BV611R	486, 488	BV695R	492, 493	DO547R	966
BV502R	485	BV615R	487	BV696R	492, 493	DO548R	966





## Numerischer Index – Numerical Index

DO – EB

Art. Nr. Cat. No.	Seite Page	Art. Nr. Cat. No.	Seite Page	Art. Nr. Cat. No.	Seite Page	Art. Nr. Cat. No.	Seite Page
DO552R	966	DP552R	100, 1072	EA140R	549	EA825R	571
DO553R	966	DP560R	129	EA141R	549	EA826R	571
DO608R	982	DP561R	129	EA145R	549	EA828R	571
DO609R	982	DP563R	129	EA146R	549	EA829R	571
DO611R	960	DP569R	129	EA150R	551	EA831R	571
DO612R	960			EA151R	551	EA843R	571
DO630R	983	EA010R	196, 538	EA152R	551	EA853R	573
DO631R	983	EA012R	196, 538	EA155R	551	EA862C	572
DO632R	983	EA013R	539	EA156R	551	EA863C	572
DO633R	983	EA014R	539	EA157R	551	EA864C	572
DO642R	960	EA015R	539	EA170R	555	EA871R	574
DO650R	982	EA016R	196, 539	EA171R	555	EA873R	574
DO651R	982	EA017R	539	EA176R	553	EA875R	574
DO655R	982	EA018R	539	EA182R	553	EA876R	574
DO656R	982	EA020R	540	EA191R	561	EA877R	575
DO670R	982	EA025R	540	EA202R	552	EA878R	575
DO671R	982	EA026R	540	EA203R	552	EA879R	575
DO672R	982	EA027R	180, 543	EA204R	552	EA880R	572
DO673R	982	EA028R	543, 838	EA205R	552	EA882R	572
DO674R	982	EA030R	540	EA206R	552	EA883R	572
DO711R	1001	EA031R	540, 839	EA207R	552	EA887R	573
DO713R	1001	EA032R	540, 839	EA210R	548	EA888R	575
DO715R	1001	EA033R	540	EA211R	548	EA889R	575
DO717R	1001	EA036R	541	EA212R	550	EA890R	579
DO720R	1005	EA037R	241, 542	EA213R	550	EA900R	580
DO722R	1002	EA039R	541	EA216R	555	EA903R	580
DO723R	1002	EA040R	541	EA217R	555	EA904R	581
DO725R	1002	EA041R	541	EA220R	547	EA905R	582
DO726R	1002	EA042R	541	EA221R	547	EA906R	582
DO728R	1005	EA050R	544, 835	EA222R	548	EA907R	582
DO730R	1005	EA052R	544, 835	EA223R	548	EA912R	581, 704
DO732R	1002	EA061R	191, 544, 837	EA240R	557	EA914R	581
DO733R	1002	EA062R	191, 544, 837	EA305R	558	EA943R	582
DO750R	1007	EA092R	544, 836	EA306R	558	EA989R	583
DO751R	1007	EA095R	544, 836	EA309R	558	EA990R	585
DO752R	1007	EA096R	544, 836	EA321R	554	EA991R	585
DO753R	1007	EA097R	544, 836	EA331R	559	EA993	585
DO754R	1007	EA099R	544, 836	EA332R	559	EA996R	586
DO755R	1007	EA100R	544, 568, 836	EA334R	559	EA997R	586
DO771R	979	EA101R	544, 836	EA336R	559	EA998R	586
DO772R	979	EA106R	547	EA338R	559	EA999P	586
DO773R	979	EA107R	547	EA355R	564		
DO811R	1056	EA114R	547	EA356R	566	EB001R	255, 590
DO812R	1056	EA116R	547	EA360R	564	EB003R	255, 590
		EA117R	547	EA362R	562	EB008R	256, 591
DP031R	1069	EA120R	548	EA365R	560	EB009R	256, 591
DP035R	1069	EA121R	548	EA397R	557	EB011R	256, 592
DP501R	1073	EA124R	548	EA440R	556	EB012R	256, 592
DP505R	1073	EA125R	548	EA441R	556	EB050	598
DP520R	1077	EA126R	550	EA450R	558	EB052C	599
DP530R	1073	EA127R	550	EA466R	557	EB061R	601
DP540R	1072	EA130R	549	EA800R	570	EB062R	601
DP541R	1072	EA131R	549	EA820R	570	EB063R	601
DP551R	129, 1072	EA132R	554	EA821R	570	EB064R	601

## Numerischer Index – Numerical Index

EB – EL

Art. Nr. Cat. No.	Seite Page	Art. Nr. Cat. No.	Seite Page	Art. Nr. Cat. No.	Seite Page	Art. Nr. Cat. No.	Seite Page
EB065R	601	EF055R	615	EF826R	630	EL181R	639
EB066R	601	EF056R	615	EF828R	630	EL182R	639
EB067R	601	EF070R	624	EF830R	630	EL183R	639
EB068R	601	EF155R	625	EF832R	630	EL184R	639
EB069R	601	EF163R	622	EF834R	630	EL185R	639
EB070R	601	EF164R	622	EF836R	630	EL192R	640
EB071R	601	EF167R	619	EF838R	630	EL193R	640
EB072R	601	EF168R	326, 622	EF840R	630	EL194R	640
EB073R	601	EF170R	622	EF842R	630	EL195R	640
EB074R	601	EF195R	625	EF844R	630	EL196R	640
EB075	601	EF208C	627	EF846R	630	EL407R	640
EB101R	599	EF210C	627	EF848R	630	EL408R	640
EB102R	599	EF212C	627	EF850R	630	EL409R	640
EB103R	599	EF214C	627	EF852R	630	EL410R	641
EB111R	602	EF216C	627	EF854R	630	EL411R	641
EB112R	602	EF218C	627	EF856R	630	EL413R	641
EB113R	602	EF220C	627	EF858R	630	EL420R	641
EB114R	602	EF306C	627	EF860R	630	EL421R	641
EB168R	602	EF308C	627	EF921R	200, 626	EL422R	641
EB169R	602	EF310C	627	EF928R	626	EL423R	641
EB170R	602	EF312C	627	EF965R	631	EL424R	641
EB171R	602	EF314C	627	EF966R	631	EL425R	641
EB172R	602	EF316C	627	EF967R	631	EL426R	641
EB173R	602	EF318C	627			EL427R	641
EB174R	602	EF400R	625	EJ126R	634	EL428R	641
EB175R	602	EF401R	625			EL440R	642
EB220R	603, 846	EF491C	628	EL010C	636	EL441R	642
EB221R	603	EF492R	628	EL011R	636	EL442R	642
EB225R	604	EF493R	628	EL013R	636	EL443R	642
EB231R	605	EF638R	600, 629	EL014R	636	EL444R	644
EB232R	605	EF639R	600, 629	EL015R	636	EL445R	644
EB233R	605	EF640R	600, 629	EL016R	636	EL446R	644
EB234R	605	EF641R	600, 629	EL040R	637	EL447R	644
EB239R	605	EF642R	600, 629	EL041R	638	EL448R	644
EB240R	605	EF643R	600, 629	EL042R	638	EL450R	643
EB242R	605	EF644R	600, 629	EL043R	638	EL451R	643
EB244R	616	EF645R	600, 629	EL044R	638	EL452R	643
EB246R	616	EF646R	600, 629	EL056R	637	EL453R	643
		EF647R	600, 629	EL057R	637	EL454R	645
EF001R	608	EF648R	600, 629	EL058R	637	EL455R	645
EF002R	608	EF649R	600, 629	EL075R	637	EL456R	645
EF003R	608	EF650R	600, 629	EL076R	638	EL457R	645
EF010R	609	EF651R	600, 629	EL077R	638	EL458R	645
EF011R	608	EF652R	600, 629	EL078R	638	EL480R	646
EF012R	610	EF653R	600, 629	EL079R	638	EL481R	646
EF015R	610	EF654R	600, 629	EL080R	638	EL491R	647
EF016R	610	EF655R	600, 629	EL081R	638	EL492R	647
EF030R	611	EF656R	600, 629	EL086R	637	EL493R	647
EF047R	614	EF657R	600, 629	EL087R	637	EL494R	647
EF048R	614	EF658R	600, 629	EL088R	637	EL495R	647
EF051R	614	EF659R	600, 629	EL150R	638	EL496R	647
EF052R	614	EF660R	600, 629	EL151R	638	EL497R	647
EF053R	614	EF790R	629	EL152R	638	EL498R	647
EF054R	614	EF824R	630	EL180R	639	EL499R	647



## Numerischer Index – Numerical Index

EL – ER

Art. Nr. Cat. No.	Seite Page	Art. Nr. Cat. No.	Seite Page	Art. Nr. Cat. No.	Seite Page	Art. Nr. Cat. No.	Seite Page
EL550R	648	EL754R	658	EM140R	662	EO122R	675
EL551R	648	EL755R	658	EM141R	662	EO125R	676
EL558R	649	EL756R	658	EM142R	662	EO130R	677
EL559R	649	EL757R	658	EM143R	662	EO140R	677
EL578R	650	EL758R	658	EM144R	662	EO150R	678
EL579R	650	EL759R	658	EM145R	662	EO151R	678
EL581R	652	EL760R	658	EM146R	662	EO163R	197, 679
EL627R	650	EL859R	654	EM147R	662	EO164R	197, 679
EL628R	650	EL860R	654	EM193R	664	EO165R	198, 680
EL629R	650	EL865R	652	EM194R	664	EO166R	198, 680
EL631R	444, 651	EL868R	417, 655	EM231R	662	EO171R	681
EL632R	444, 651	EL870R	417, 655	EM232R	662, 663	EO177R	681
EL633R	444, 651	EL872R	417, 655	EM233R	662, 663	EO180R	682
EL634R	444, 651	EL873R	417, 655	EM234R	662, 663	EO202R	682
EL635R	444, 651			EM235R	662, 663	EO216R	683
EL636R	444, 651	EM097R	664	EM236R	662, 663	EO218R	683
EL637R	444, 651	EM098R	664	EM237R	662, 663	EO220R	684
EL638R	444, 651	EM099R	664	EM238R	662, 663	EO221R	684
EL639R	444, 651	EM100R	664	EM239R	662, 663	EO222R	684
EL642R	444, 651	EM101R	662, 664	EM244R	663	EO225R	684
EL644R	444, 651	EM102R	662, 664	EM245	663	EO226R	684
EL660R	651	EM103R	662, 664	EM271R	663	EO240R	684
EL690R	653	EM104R	662, 664	EM272R	663	EO242R	684
EL691R	653	EM105R	662, 664	EM273R	663	EO300R	688
EL693R	653	EM106R	662, 664	EM274R	663	EO310R	193, 594, 686
EL694R	653	EM107R	662, 664	EM275R	663	EO315R	193, 686
EL695R	653	EM108R	662, 664	EM276R	663	EO332R	596, 687
EL697R	653	EM109R	662, 664	EM277R	663	EO338R	191, 584, 595, 687, 837
EL698R	653	EM110R	662, 664	EM278R	663	EO340R	191, 584, 595, 687, 837
EL700R	653	EM111R	662, 664	EM710R	667	EO342R	688
EL702R	653	EM112R	662, 664	EM711R	667	EO405R	613, 688
EL703R	653	EM113R	662, 664			EO407R	613, 689
EL704R	653	EM114R	662, 664	EO005R	598, 670	EO415R	689
EL705R	653	EM115R	662, 664	EO010R	670	EO420R	689
EL707R	653	EM116R	662, 664	EO012R	670	EO433R	690
EL708R	653	EM117R	662, 664	EO013R	670	EO435R	690
EL720C	654	EM118R	662, 664	EO015R	670		
EL721C	654	EM119R	662, 664	EO016R	671	ER002R	697
EL722C	654	EM120R	662, 664	EO020	671	ER005R	626, 697
EL736R	656	EM121R	662, 664	EO030R	671	ER011R	698
EL738R	656	EM122R	662, 664	EO060R	200, 672	ER012R	698
EL739R	656	EM123R	662, 664	EO061R	200, 604, 672	ER015R	698
EL740R	657	EM124R	662, 664	EO075R	672	ER016R	698
EL741R	657	EM125R	662, 664	EO077R	672	ER025R	711
EL742R	657	EM126R	662, 664	EO080R	673	ER050R	699
EL743R	657	EM131R	662	EO082R	673	ER054R	700
EL744R	657	EM132R	662	EO085R	673	ER055R	700
EL745R	657	EM133R	662	EO105R	674	ER058R	699
EL746R	657	EM134R	662	EO106R	674	ER061R	701
EL747R	657	EM135R	662	EO108R	675	ER062R	701
EL748R	657	EM136R	662	EO110R	199, 675	ER063R	701
EL751R	658	EM137R	662	EO111R	676	ER064R	701
EL752R	658	EM138R	662	EO112R	199, 676	ER066R	703
EL753R	658	EM139R	662	EO115R	677	ER068R	706

## Numerischer Index – Numerical Index

ER – FB

Art. Nr. Cat. No.	Seite Page	Art. Nr. Cat. No.	Seite Page	Art. Nr. Cat. No.	Seite Page	Art. Nr. Cat. No.	Seite Page
ER070R	703	ER402R	709	ET106R	722	FB055R	888
ER071R	704	ER403R	709	ET130R	724	FB108R	851
ER072R	702	ER404R	709	ET140R	124, 724	FB109R	851
ER073R	702	ER405R	709	ET141R	124, 724, 856	FB110R	851
ER076R	702	ER406R	709	ET142R	124, 724	FB112R	851
ER101R	707, 988	ER411R	709	ET150R	123, 723	FB113R	851
ER102R	707, 988	ER412R	709	ET152R	123, 723	FB114R	851
ER103R	707, 988	ER413R	709	ET160R	724	FB115R	851
ER104R	707, 988	ER414R	709	ET205R	726	FB116R	851
ER105R	707, 988	ER415R	709	ET210R	726	FB117R	851
ER106R	707, 988	ER416R	709	ET220R	727	FB119R	851
ER111R	707	ER421R	709	ET221R	727	FB120R	889
ER112R	707	ER422R	709	ET237R	727	FB121R	889
ER113R	707	ER423R	709	ET245R	728	FB122R	889
ER114R	707	ER424R	709	ET246R	728	FB124R	889
ER115R	707	ER425R	709	ET251R	729	FB125R	889
ER116R	707	ER426R	709	ET255R	729	FB126R	889
ER126R	707	ER520R	710	ET268R	730	FB150R	849
ER128R	707	ER521R	710	ET269R	731	FB151R	849
ER130R	707	ER522R	710	ET270R	730	FB153R	846
ER132R	707	ER523R	710	ET301R	732	FB154R	846
ER134R	707	ER524R	710	ET302R	732	FB155R	846
ER219R	708	ER525R	710	ET306R	732	FB156R	846
ER220R	708	ER526R	710	ET307R	732	FB158R	850
ER221R	708	ER580R	711	ET308R	732	FB159R	850
ER222R	708	ER585R	711	ET315R	732	FB160R	847
ER223R	708	ER602R	712	ET316R	732	FB161R	847
ER224R	708	ER611R	713	ET320R	734	FB162R	847
ER225R	708	ER612R	713	ET325R	733	FB163R	847
ER226R	708	ER621R	713	ET326R	733	FB164R	847
ER227R	708	ER623R	713	ET327R	733	FB165R	847
ER228R	708	ER626R	713	ET329R	735	FB166R	847
ER229R	708	ER627R	713			FB167R	847
ER230R	708	ER628R	713	FA001R	456	FB168R	847
ER241R	708	ER820C	715	FA005R	474	FB169R	847
ER242R	708	ER822C	715	FA006R	474	FB170R	847
ER243R	708	ER825C	715	FA007R	474	FB172R	847
ER244R	708	ER826C	715	FA025R	364	FB180R	852
ER245R	708	ER827C	715	FA026R	364	FB184R	852
ER246R	708	ER828C	715			FB185R	852
ER247R	708	ER829	715	FB030R	887	FB186R	852
ER248R	708	ER867R	717	FB031R	887, 888	FB194R	852
ER320R	708	ER871R	716	FB032R	887	FB195R	852
ER321R	708	ER872R	716	FB033	887	FB196R	852
ER322R	708	ER873R	716	FB034R	887	FB222R	738
ER323R	708	ER874R	716	FB035R	887	FB223R	739
ER324R	708	ER875	717	FB036R	887	FB224R	739
ER325R	708	ER876	717	FB037R	887	FB226R	739
ER326R	708			FB038R	887	FB227R	739
ER327R	708	ET002	720	FB040R	887	FB234R	740
ER328R	708	ET005R	720	FB050R	888	FB235R	741
ER329R	708	ET073R	720	FB051R	888	FB236R	741
ER330R	708	ET096R	721	FB053R	888	FB238R	741
ER401R	709	ET102R	722	FB054R	888		



## Numerischer Index – Numerical Index

FB

Art. Nr. Cat. No.	Seite Page	Art. Nr. Cat. No.	Seite Page	Art. Nr. Cat. No.	Seite Page	Art. Nr. Cat. No.	Seite Page
FB239R	741	FB424R	219, 789	FB485R	798	FB554R	804
FB240R	742	FB425R	219, 789	FB486R	797	FB557R	792
FB242R	743	FB426R	219, 789	FB487R	797	FB558R	792
FB243R	742	FB427R	219, 789	FB488R	818	FB559R	793
FB245R	743	FB431R	218, 788	FB489R	818	FB560R	793
FB246R	744	FB432R	219, 789	FB490R	819	FB561R	793
FB248R	745	FB433R	219, 789	FB491R	819	FB563R	793
FB249R	744	FB434R	219, 789	FB492R	819	FB567R	792
FB251R	745	FB435R	219, 789	FB493R	563, 811	FB568R	792
FB252R	744	FB436R	219, 789	FB494R	563, 811	FB569R	792
FB253R	745	FB437R	219, 789	FB495R	817	FB570R	793
FB254R	742	FB440R	794	FB496R	797	FB573R	812
FB255R	743	FB441R	794	FB497R	797	FB574R	812
FB328R	217, 787	FB442R	794	FB498R	798	FB576R	817
FB329R	217, 787	FB443R	794	FB499R	798	FB578R	816
FB330R	217, 787	FB444R	795	FB500R	801	FB581R	791
FB331R	217, 787	FB445R	795	FB501R	801	FB582R	791
FB352R	218, 788	FB446R	794	FB502R	801	FB587R	803
FB353R	218, 788	FB447R	794	FB503R	801	FB588R	803
FB357R	218, 788	FB448R	794	FB504R	801	FB590R	791
FB358R	218, 788	FB449R	794	FB506R	802	FB591R	791
FB359R	218, 788	FB450R	805	FB507R	802	FB592R	791
FB362R	218, 788	FB451R	805	FB508R	802	FB593R	791
FB363R	218, 788	FB452R	804	FB510R	809	FB600R	843
FB364R	218, 788	FB453R	804	FB511R	809	FB602R	843
FB365R	218, 788	FB454R	804	FB512R	809	FB604R	843
FB366R	218, 788	FB455R	804	FB513R	809	FB605R	843
FB367R	218, 788	FB456R	804	FB515R	810	FB633R	844
FB369R	218, 788	FB457R	804	FB516R	810	FB634R	844
FB394R	160, 782	FB458R	799	FB517R	810	FB635R	844
FB395R	160, 782	FB459R	799	FB518R	810	FB651R	851
FB396R	160, 782	FB460R	799	FB519R	800	FB653R	851
FB400R	160, 546, 782	FB461R	799	FB520R	800	FB654R	851
FB401R	161, 783	FB462R	799	FB521R	800	FB700R	820
FB402R	160, 546, 782	FB463R	806	FB522R	800	FB701R	820
FB403R	161, 783	FB464R	806	FB523R	800	FB702R	820
FB404R	160, 546, 782	FB465R	806	FB524R	800	FB703R	820
FB405R	160, 546, 782	FB466R	807	FB525R	816	FB704R	820
FB406R	161, 546, 783	FB467R	807	FB526R	795	FB705R	820
FB407R	161, 546, 783	FB468R	807	FB527R	795	FB706R	820
FB408R	161, 546, 783	FB469R	807	FB528R	796	FB707R	820
FB409R	161, 546, 567, 783	FB470R	807	FB529R	796	FB708R	820
FB411R	160, 782	FB471R	815	FB530R	796	FB710R	826
FB412R	160, 782	FB472R	815	FB532R	795	FB711R	826
FB414R	160, 546, 782	FB473R	815	FB533R	795	FB712R	826
FB415R	160, 546, 782	FB475R	815	FB534R	795	FB713R	826
FB416R	160, 546, 782	FB476R	814	FB535R	795	FB714R	826
FB417R	160, 546, 782	FB477R	814	FB540R	790	FB715R	826
FB418R	160, 782	FB478R	814	FB541R	790	FB717R	824
FB419R	160, 782	FB480R	815	FB542R	790	FB718R	824
FB420R	219, 789	FB481R	813	FB543R	790	FB719R	824
FB421R	219, 789	FB482R	813	FB544R	790	FB721R	823
FB422R	219, 789	FB483R	798	FB552R	804	FB722R	823
FB423R	219, 789	FB484R	798	FB553R	804	FB723R	823

## Numerischer Index – Numerical Index

FB – FD

Art. Nr. Cat. No.	Seite Page	Art. Nr. Cat. No.	Seite Page	Art. Nr. Cat. No.	Seite Page	Art. Nr. Cat. No.	Seite Page
FB724R	823	FB821R	874	FC004R	853	FD080R	282, 770
FB725R	823	FB822R	874	FC005R	853	FD081R	282, 770
FB726R	823	FB823R	874	FC014R	853	FD100R	53
FB727R	823	FB830R	866	FC015R	853	FD101R	53
FB729R	825	FB835R	867	FC025R	853	FD103R	53
FB730R	825	FB836R	867	FC030	853	FD230R	283, 771
FB731R	822	FB840R	877	FC034R	853	FD231R	283, 771
FB732R	822	FB841R	877	FC035R	853	FD232R	283, 771
FB734R	822	FB842R	877	FC040A	864	FD233R	283, 771
FB735R	822	FB844R	877	FC041A	864	FD240R	284, 772
FB736R	825	FB845R	872	FC042A	864	FD241R	284, 772
FB737R	825	FB846R	872	FC043A	864	FD242R	284, 772
FB738R	828	FB847R	866	FC044A	865	FD243R	284, 772
FB741R	821	FB850R	873	FC048R	854	FD244R	284, 772
FB742R	821	FB851R	873	FC049R	854	FD245R	284, 772
FB743R	821	FB852R	865	FC060R	875, 876	FD246R	284, 772
FB754R	827	FB853R	865	FC061R	876	FD247R	284, 772
FB755R	827	FB854R	865	FC062R	876	FD251R	60, 768
FB756R	827	FB855R	865	FC063R	876	FD252R	60, 768
FB764R	832	FB856R	865	FC064R	876	FD253R	150, 769
FB765R	833	FB857R	865	FC300R	834	FD255R	769
FB766R	827	FB858R	865	FC301R	834	FD258R	297, 769
FB767R	827	FB860R	882	FC302R	834	FD259R	297, 769
FB773R	829	FB861R	882	FC303R	834	FD280R	143
FB775R	830	FB862R	882	FC304R	834	FD281R	143
FB776R	831	FB865R	883	FC310R	834	FD284R	143
FB777R	831	FB866R	883	FC311R	834	FD285R	143
FB778R	831	FB870R	857	FC312R	834	FD286R	143
FB779R	831	FB873R	857	FC313R	834	FD287R	143
FB780R	831	FB878R	857	FC314R	834	FD333R	849
FB784R	161, 783	FB881R	857	FC411R	159, 546, 781	FD375R	363
FB785R	161, 783	FB882R	857	FC412R	159, 546, 781	FD376R	363
FB786R	161, 783	FB890R	858	FC413R	159, 546, 781	FD392R	363
FB795R	828	FB892R	858	FC418R	159, 546, 781	FD394R	358
FB800R	867	FB911R	855			FD395R	358
FB802R	867	FB918R	856	FD011R	50	FD396R	358
FB803R	868	FB930R	542, 839	FD012R	50	FD397R	358
FB804R	868	FB934R	540, 839	FD013R	50	FD398R	358
FB805R	869	FB936R	545, 835	FD014R	50	FD399R	358
FB806R	869	FB938R	539, 839	FD015R	50	FD552R	210
FB807R	869	FB940R	842	FD016R	51	FD554R	210
FB808R	870	FB950R	845	FD017R	51	FD556R	210
FB809R	870	FB954R	273, 561, 845	FD018R	52	FD558R	210
FB810R	870	FB955R	273, 561, 845	FD019R	52	FD560R	210
FB811R	870	FB956R	272, 560, 808	FD020R	52	FD561R	210
FB812R	870	FB957R	272, 560, 808	FD021R	52	FD562R	210
FB813R	871	FB958R	272, 560, 808	FD022R	52	FD568R	210, 211
FB814R	871	FB961R	840	FD023R	52	FD569R	210, 211
FB815R	871	FB971R	884	FD028R	51	FD571R	211
FB816R	871	FB972R	884	FD045R	282, 770	FD572R	211
FB817R	871	FB973R	884	FD046R	282, 770	FD575R	212
FB818R	871	FB974R	884	FD048R	282, 770	FD578R	210
FB819R	871	FB975R	884	FD076R	282, 770	FD610R	1046
FB820R	874	FB976R	884	FD079R	282, 770	FD611R	211



# Numerischer Index – Numerical Index

FD – FH

Art. Nr. Cat. No.	Seite Page	Art. Nr. Cat. No.	Seite Page	Art. Nr. Cat. No.	Seite Page	Art. Nr. Cat. No.	Seite Page
FD612R	211	FF066R	1052	FF662R	897	FF771R	897
FD613R	211	FF067R	1052	FF663R	897	FF772R	897
FD614R	211	FF068R	1052	FF664R	897	FF773R	897
FD615R	211	FF130R	925	FF665R	897	FF774R	903
FD635R	212	FF133C	925	FF682R	897	FF775R	903
FD636R	212	FF291R	928	FF683R	897	FF776R	903
		FF292R	928	FF684R	897	FF777R	903
FE005K	213	FF293R	928	FF685R	897	FF778R	903
FE010K	213	FF294R	928	FF692R	898	FF779R	903
FE011K	213	FF295R	929	FF693R	898	FF781R	898
FE012K	213	FF300R	850	FF694R	898	FF782R	898
FE013K	213	FF301R	850	FF695R	898	FF783R	898
FE014K	213	FF302R	850	FF707R	376	FF784R	898
FE020K	213	FF308R	929	FF708R	376	FF785R	898
FE021K	213	FF309	339	FF709R	376	FF799R	902
FE022K	213	FF313R	360	FF711R	898	FF800R	902
FE023K	213	FF321R	360	FF712R	898	FF801R	902
FE024K	213	FF322R	360	FF713R	898	FF803R	906
FE030S	214, 784	FF345R	909	FF714R	898	FF805R	906
FE031S	214, 784	FF346R	962	FF715R	897	FF806R	907
FE032S	215, 785	FF347R	929	FF716R	896	FF807R	906
FE034S	215, 785	FF348R	929	FF717R	897	FF808R	911
FE040S	214, 784	FF349R	929	FF718R	896	FF810R	907
FE041S	214, 784	FF502R	905	FF719R	896	FF811R	907
FE042S	215, 785	FF503R	905	FF720R	897	FF814R	907
FE044S	215, 785	FF504R	905	FF721R	896	FF818R	911
		FF513R	905	FF722R	897	FF820R	909
		FF514R	905	FF723R	896	FF832R	904
FF011R	731	FF523R	906	FF724R	897	FF833R	904
FF031R	1053	FF524R	906	FF725R	898	FF834R	904
FF032R	1053	FF532R	905	FF726R	897	FF835R	904
FF033R	1053	FF533R	905	FF727R	897	FF842R	904
FF034R	1053	FF534R	905	FF728R	897	FF843R	904
FF035R	1053	FF535R	905	FF729R	897	FF844R	904
FF036R	1053	FF536R	905	FF730R	929	FF852R	904
FF037R	1053	FF543R	905	FF737R	897	FF853R	904
FF038R	1053	FF544R	905	FF738R	897	FF854R	904
FF039R	1053	FF545R	905	FF741R	896	FF856R	910
FF040R	1053	FF553R	906	FF742R	896	FF857R	910
FF041R	1053	FF554R	906	FF743R	896	FF858R	910
FF042R	1053	FF562R	905	FF746R	897	FF913R	997
FF043R	1053	FF563R	905	FF747R	897	FF914R	997
FF044R	1053	FF564R	905	FF748R	897	FF915R	997
FF047R	1053	FF565R	905	FF749R	897		
FF048R	1053	FF566R	905	FF750R	896	FG052R	1035
FF052R	1053	FF573R	905	FF752R	896	FG055R	895
FF053R	1053	FF574R	905	FF754R	896	FG057R	912
FF055R	1052	FF575R	905	FF755R	896		
FF056R	1052	FF583R	906	FF765R	902	FH001	916
FF057R	1052	FF584R	906	FF766R	902	FH002	916
FF061R	1052	FF599R	908	FF767R	902	FH003	916
FF062R	1052	FF600R	908	FF768R	902	FH004	916
FF063R	1052	FF605R	908	FF769R	897	FH005	916
FF064R	1052	FF661R	897	FF770R	897	FH010	916
FF065R	1052						

## Numerischer Index – Numerical Index

FH – FK

Art. Nr. Cat. No.	Seite Page	Art. Nr. Cat. No.	Seite Page	Art. Nr. Cat. No.	Seite Page	Art. Nr. Cat. No.	Seite Page
FH014	916	FK130R	931	FK245R	953	FK384R	862, 975
FH100R	28, 917	FK131R	931	FK246R	954	FK387R	862, 975
FH101R	28, 917	FK133R	931	FK251	959	FK390R	971
FH102R	28, 917	FK135R	933	FK252	959	FK391R	972
FH103R	28, 917	FK136R	933	FK253	959	FK394R	969
FH116R	28, 917	FK139R	931	FK254	959	FK395R	969
FH150R	28, 917	FK140R	933	FK291R	964	FK396R	969
FH160R	29, 918	FK141R	930	FK292R	964	FK397R	969
FH166R	29, 918	FK146R	974	FK293R	964	FK400R	861, 976
FH170R	29, 918	FK147R	974	FK299R	968	FK401R	861, 976
FH191R	29, 918	FK148R	974	FK300R	961	FK402R	861, 976
FH192R	29, 918	FK149R	974	FK301R	968	FK403R	861, 976
FH194R	33, 919	FK156R	934	FK302R	968	FK408R	861, 976
FH197R	33, 919	FK157R	974	FK303R	961	FK409R	861, 976
FH220R	920	FK158R	944	FK306R	968	FK410R	972
FH222R	920	FK160R	934	FK307R	968	FK411R	972
FH300R	921	FK161R	935	FK308R	968	FK412R	972
FH301C	921	FK162R	935	FK309R	968	FK413R	972
FH302C	921	FK166R	937	FK310R	961	FK414R	972
FH305R	921	FK167R	936	FK314R	969	FK420R	863, 974
FH306R	921	FK168R	943	FK317R	970	FK505R	980
FH307C	921	FK169R	943	FK318R	970	FK507R	980
FH308C	921	FK170R	936	FK319R	970	FK510R	980
FH310C	921	FK171R	937	FK321R	970	FK511R	980
FH312C	921	FK172R	940	FK323R	970	FK530R	967
FH313R	922	FK173R	940	FK324R	970	FK532R	967
FH314C	922	FK174R	938	FK325R	970	FK534R	967
FH315C	922	FK175R	938	FK328R	969	FK541R	967
FH316C	922	FK176R	939	FK329R	969	FK542R	967
FH320R	922	FK177R	944	FK336R	973	FK543R	967
FH325R	923	FK180R	945	FK340R	971	FK552R	967
FH326R	923	FK185R	936	FK341R	971	FK562R	967
FH335R	923	FK186R	937	FK344R	971	FK611R	984
FH403	924	FK187R	942	FK345R	971	FK612R	984
FH404	924	FK188R	939	FK348R	977	FK613R	984
FH405	924	FK189R	941	FK350R	971	FK614R	984
FH407	924	FK193R	945	FK351R	973	FK615R	984
FH413	924	FK211R	947	FK352R	977	FK616R	984
FH414	924	FK212R	947	FK353R	977	FK617R	984
FH415	924	FK213R	947	FK355R	863, 973	FK621R	984
FH430R	924	FK214R	950	FK356R	863, 973	FK622R	984
FH480R	924	FK215R	950	FK357R	863, 973	FK623R	984
		FK218R	948	FK358R	863, 973	FK624R	984
FK110R	930	FK219R	948	FK359R	863, 973	FK625R	984
FK111R	932	FK221R	957	FK360R	863, 972	FK626R	984
FK113R	932	FK222R	955	FK361R	972	FK627R	984
FK114R	932	FK223R	952	FK362R	972	FK630R	984
FK116R	932	FK224R	949	FK365R	973	FK631R	984
FK117R	932	FK231R	958	FK366R	973	FK632R	984
FK118R	932	FK238R	959	FK378R	972	FK633R	984
FK119R	932	FK239R	951	FK379R	971	FK634R	984
FK120R	930	FK241R	956	FK381R	862, 975	FK635R	984
FK121R	930	FK243R	953	FK382R	862, 975	FK636R	984
FK124R	931	FK244R	954	FK383R	862, 975	FK637R	984





## Numerischer Index – Numerical Index

FK – FL

Art. Nr. Cat. No.	Seite Page	Art. Nr. Cat. No.	Seite Page	Art. Nr. Cat. No.	Seite Page	Art. Nr. Cat. No.	Seite Page
FK638R	984	FK845R	981	FK932R	898	FL060R	995
FK639R	984	FK846R	981	FK933R	898	FL062	994
FK658R	984	FK848R	982	FK934R	898	FL064R	994
FK659R	984	FK850R	981	FK936R	898	FL065	994
FK660R	983	FK854R	989	FK937R	898	FL066R	996
FK661R	983	FK855R	989	FK938R	898	FL068C	996
FK662R	985	FK863R	989	FK939R	898	FL069C	996
FK663R	985	FK864R	989	FK940R	898	FL070S	995
FK664R	985	FK900B	897	FK943R	898	FL090R	997
FK665R	985	FK900R	897	FK944R	898	FL091R	997
FK666R	989	FK901B	897	FK945R	898	FL092R	997
FK668R	989	FK901R	897	FK946R	898	FL093R	997
FK670R	989	FK902B	897	FK948B	896	FL094R	997
FK672R	989	FK902R	897	FK948R	896	FL095R	997
FK675R	985	FK903B	897	FK949B	896	FL096R	997
FK676R	985	FK903R	897	FK949R	896	FL097R	997
FK677R	985	FK904B	897	FK950B	896	FL098R	997
FK678R	985	FK904R	897	FK950R	896	FL101R	1001
FK679R	985	FK905B	897	FK951B	896	FL102R	1001
FK684R	985	FK905R	897	FK951R	896	FL104R	1001
FK685R	985	FK906B	897	FK952B	896	FL106R	1001
FK686R	985	FK906R	897	FK952R	896	FL108R	1001
FK688R	988	FK907B	897	FK953B	896	FL109R	1001
FK689R	988	FK907R	897	FK953R	896	FL110R	999
FK690R	988	FK908B	897	FK954R	896	FL112R	999
FK702R	986	FK908R	897	FK955R	896	FL114R	999
FK703R	986	FK909B	897	FK956R	896	FL116R	999
FK704R	986	FK909R	897	FK957R	896	FL118R	999
FK705R	986	FK910B	897	FK958R	896	FL120R	999
FK712R	986	FK910R	897	FK959R	896	FL122R	999
FK713R	986	FK913B	897	FK961B	897	FL124R	999
FK714R	986	FK913R	897	FK961R	897	FL126R	999
FK715R	986	FK914B	897	FK962B	897	FL128R	999
FK723R	986	FK914R	897	FK962R	897	FL130R	999
FK724R	986	FK915B	897	FK963B	897	FL132R	999
FK725R	986	FK915R	897	FK963R	897	FL134R	999
FK773R	988	FK916B	897	FK964B	897	FL136R	999
FK774R	988	FK916R	897	FK964R	897	FL138R	999
FK775R	988	FK917B	897	FK965B	897	FL144R	998
FK783R	988	FK917R	897	FK965R	897	FL146R	998
FK784R	988	FK919R	897			FL148R	998
FK785R	988	FK920R	897	FL010	994	FL153R	998
FK800R	981	FK921R	897	FL011	994	FL173R	1000
FK801R	981	FK922R	897	FL034	992	FL174R	1000
FK803R	981	FK925B	897	FL035R	992	FL175R	1000
FK813R	981	FK925R	897	FL036R	992	FL176R	1000
FK814R	981	FK926B	897	FL037	992	FL183R	1000
FK817R	981	FK926R	897	FL038R	992	FL184R	1000
FK834R	988	FK927B	897	FL039R	992	FL185R	1000
FK835R	988	FK927R	897	FL044R	993	FL186R	1000
FK836R	988	FK928B	897	FL045R	994	FL187R	1000
FK840R	981	FK928R	897	FL047	994	FL213R	1000
FK841R	981	FK930R	898	FL055R	995	FL214R	1000
FK842R	981	FK931R	898	FL059R	996	FL215R	1000

## Numerischer Index – Numerical Index

FL – FM

Art. Nr. Cat. No.	Seite Page	Art. Nr. Cat. No.	Seite Page	Art. Nr. Cat. No.	Seite Page	Art. Nr. Cat. No.	Seite Page
FL216R.....	1000	FL523R .....	1003	FM010R.....	55	FM476R .....	59, 749
FL223R .....	1000	FL524R .....	1003	FM011R.....	55	FM477R .....	59, 749
FL224R .....	1000	FL525R .....	1003	FM012R.....	55	FM478R .....	59, 749
FL225R .....	1000	FL526R .....	1003	FM013R.....	55	FM479R .....	59, 749
FL226R .....	1000	FL527R .....	1003	FM014R.....	55	FM480R .....	59, 749
FL227R .....	1000	FL553R .....	1003	FM021R.....	285	FM481R .....	59, 749
FL343R.....	1001	FL554R .....	1003	FM033R.....	142	FM482R .....	59, 749
FL345R.....	1001	FL555R.....	1003	FM034R.....	142	FM483R .....	59, 749
FL347R.....	1001	FL556R.....	1003	FM035R.....	142	FM484R .....	59, 749
FL380R.....	1007	FL557R.....	1003	FM036R.....	142	FM485R.....	59, 749
FL381R.....	1007	FL573R.....	1003	FM040R.....	55	FM486R.....	59, 749
FL382R.....	1007	FL574R.....	1003	FM041R.....	55	FM488R.....	59, 749
FL383R.....	1007	FL575R.....	1003	FM042R.....	60, 768	FM489R.....	59, 749
FL384R.....	1007	FL576R.....	1003	FM043R.....	60, 768	FM490R.....	59, 749
FL390R.....	1007	FL577R.....	1003	FM047R.....	769	FM491R.....	59, 749
FL391R.....	1007	FL583R.....	1003	FM053R.....	150, 755	FM492R.....	59, 749
FL392R.....	1007	FL585R.....	1003	FM054R.....	150, 755	FM493R.....	59, 749
FL393R.....	1007	FL650R.....	1005	FM061R.....	285	FM503R.....	59, 749
FL394R.....	1007	FL651R.....	1005	FM063R.....	150, 755	FM504R.....	59, 749
FL401R.....	1008	FL652R.....	1005	FM218R.....	289, 759	FM505R.....	59, 749
FL402R.....	1008	FL653R.....	1005	FM221R.....	289, 759	FM506R.....	59, 749
FL403R.....	1008	FL654R.....	1005	FM223R.....	289, 759	FM507R.....	59, 749
FL405R.....	1008	FL655R.....	1005	FM228R.....	289, 759	FM508R.....	59, 749
FL406R.....	1008	FL656R.....	1005	FM230R.....	289, 759	FM520R.....	289, 759
FL407R.....	1008	FL658R.....	1005	FM236R.....	297, 767	FM521R.....	289, 759
FL408R.....	1008	FL659R.....	1005	FM276R.....	297, 767	FM522R.....	289, 759
FL411R.....	1008	FL660R.....	1005	FM388R.....	287, 774	FM523R.....	289, 759
FL412R.....	1008	FL661R.....	1005	FM390R.....	287, 774	FM524R.....	289, 759
FL413R.....	1008	FL662R.....	1005	FM392R.....	772	FM525R.....	289, 759
FL415R.....	1008	FL665R.....	1006	FM398R.....	772	FM526R.....	289, 759
FL416R.....	1008	FL666R.....	1006	FM430R.....	57, 747	FM527R.....	289, 759
FL417R.....	1008	FL668R.....	1006	FM431R.....	57, 747	FM528R.....	289, 759
FL418R.....	1008	FL670R.....	1006	FM432R.....	57, 747	FM529R.....	289, 759
FL420R.....	1008	FL672R.....	1006	FM433R.....	57, 747	FM530R.....	289, 759
FL423R.....	1010	FL682R.....	1006	FM434R.....	57, 747	FM531R.....	289, 759
FL430R.....	1010	FL685R.....	1006	FM435R.....	57, 747	FM532R.....	289, 759
FL437R.....	1009	FL686R.....	1006	FM436R.....	57, 747	FM533R.....	289, 759
FL438R.....	1009	FL687R.....	1006	FM437R.....	57, 747	FM534R.....	291, 761
FL439R.....	1009	FL701R.....	1008	FM438R.....	57, 747	FM535R.....	291, 761
FL440R.....	1009	FL702R.....	1008	FM439R.....	57, 747	FM536R.....	291, 761
FL441R.....	1009	FL711R.....	998	FM440R.....	57, 747	FM537R.....	291, 761
FL443R.....	1009	FL781R.....	1005	FM441R.....	57, 747	FM538R.....	291, 761
FL445R.....	1009	FL783R.....	1005	FM442R.....	57, 747	FM539R.....	291, 761
FL503R.....	1003	FL785R.....	1005	FM444R.....	57, 747	FM540R.....	293, 763
FL504R.....	1003	FL788R.....	1005	FM451R.....	57, 747	FM541R.....	293, 763
FL505R.....	1003	FL789R.....	1005	FM452R.....	57, 747	FM542R.....	293, 763
FL506R.....	1003	FL790R.....	1005	FM453R.....	57, 747	FM543R.....	293, 763
FL507R.....	1003			FM454R.....	57, 747	FM544R.....	293, 763
FL512R.....	1003	FM001R.....	141	FM455R.....	57, 747	FM545R.....	293, 763
FL513R.....	1003	FM002R.....	141	FM470R.....	57, 747	FM546R.....	293, 763
FL514R.....	1003	FM003R.....	141	FM471R.....	57, 747	FM547R.....	293, 763
FL515R.....	1003	FM004R.....	141	FM472R.....	57, 747	FM548R.....	293, 763
FL516R.....	1003	FM005R.....	141	FM473R.....	57, 747	FM549R.....	293, 763
FL517R.....	1003	FM006R.....	141	FM474R.....	57, 747	FM550R.....	295, 765



## Numerischer Index – Numerical Index

FM – FR

Art. Nr. Cat. No.	Seite Page	Art. Nr. Cat. No.	Seite Page	Art. Nr. Cat. No.	Seite Page	Art. Nr. Cat. No.	Seite Page
FM551R	295, 765	FO116R	1015	FO428R	1028	FO634R	1039
FM552R	295, 765	FO117R	1014	FO430R	1028	FO636R	1039
FM553R	295, 765	FO118R	1015	FO432R	1028	FO640R	1040
FM554R	295, 765	FO119R	1014	FO440R	1029	FO641R	1040
FM555R	295, 765	FO120R	1018	FO442R	1029	FO645R	1041
FM560R	296, 766	FO123R	1016	FO450R	1029	FO646R	1041
FM561R	296, 766	FO124R	1016	FO451R	1029	FO647R	1041
FM563R	289, 759	FO125R	1016	FO453R	1029	FO648R	859, 1042
FM564R	289, 759	FO127R	1018	FO455R	1029	FO649R	859, 1042
FM565R	289, 759	FO130R	1018	FO457R	1028	FO800R	1043
FM566R	289, 759	FO135R	859, 1018	FO460R	1030	FO801R	1043
FM567R	289, 759	FO136R	859, 1018	FO461R	1030	FO807R	1043
FM568R	289, 759	FO140R	1019	FO462R	1030	FO808R	1043
FM570R	145, 753	FO141R	1019	FO463R	1030	FO810R	1043
FM571R	145, 753	FO143R	1019	FO467R	1030	FO816R	1043
FM572R	145, 753, 769	FO144R	1022	FO470R	1030	FO820R	913
FM573R	145, 753	FO145R	1022	FO472R	1030	FO855R	1044
FM574R	145, 753	FO146R	1022	FO474R	1031	FO856R	1044
FM575R	145, 753	FO148R	1021	FO475R	1031	FO857R	1044
FM576R	145, 753	FO150R	1020	FO500R	1032	FO900R	1079
FM577R	145, 753	FO151R	1020	FO502R	1032	FO901R	1079
FM578R	145, 753	FO153R	1016	FO511R	1032	FO903R	1079
FM579R	145, 753	FO158R	1021	FO514R	1032	FO912R	1049
FM580R	145, 753	FO159R	1021	FO515R	1032	FO913R	1049
FM581R	145, 753	FO160R	1024	FO518R	1032	FO919	1049
FM582R	147, 755	FO161R	1024	FO520R	1032	FO920	1049
FM583R	145, 753	FO162R	1024	FO521R	1032	FO923R	1046
FM584R	147, 755	FO169R	1023	FO522R	1033	FO925R	1046
FM585R	145, 753	FO170R	1023	FO523R	1033	FO928R	1046
FM586R	147, 755	FO171R	1023	FO525R	1033	FO930R	1046
FM587R	147, 755	FO172R	1023	FO526R	1033	FO931R	1047
FM588R	147, 755	FO173R	1023	FO527R	1033	FO932R	1047
FM589R	147, 755	FO180R	1023	FO530R	1034	FO933R	1047
FM590R	147, 755	FO181R	1023	FO532R	1034	FO934R	1047
FM591R	147, 755	FO182R	1023	FO534R	1034	FO935R	1047
FM592R	145, 753	FO183R	1023	FO550R	1035	FO937R	1047
FM593R	145, 753	FO190R	1025	FO551R	1035	FO939R	1047
FM594R	145, 753	FO191R	1025	FO555R	860, 1036	FO940R	1048
FM595R	145, 753	FO192R	1025	FO566R	1036	FO950R	194
FM596R	145, 753	FO193R	1025	FO570R	860, 1037	FO951R	194
FM597R	147, 755	FO199R	1025	FO572R	860, 1037		
FM598R	147, 755	FO216R	116	FO599R	1026	FR005R	1054
FM599R	145, 753	FO399R	1026	FO601R	1038	FR010R	1054
FM600R	145, 753	FO400R	1026	FO602R	1038	FR011R	1054
		FO406R	1026	FO604R	1038	FR103R	1064
FO100R	1017	FO407R	1026	FO610R	1040	FR105R	1064
FO105R	1015	FO408R	1026	FO611R	1040	FR110R	1055
FO106R	1015	FO409R	1026	FO612R	1040	FR118R	1055
FO108R	1015	FO410R	1027	FO614R	1040	FR120R	1055
FO110R	1017	FO411R	1027	FO620R	1039	FR125R	1055
FO111R	1017	FO412R	1028	FO622R	1039	FR140R	1057
FO112R	1016	FO413R	1027	FO624R	1039	FR141R	1057
FO113R	1014	FO415R	1028	FO626R	1039	FR142R	1057
FO115R	1014	FO416R	1028	FO632R	1039		

## Numerischer Index – Numerical Index

GA - GK

Art. Nr. Cat. No.	Seite Page	Art. Nr. Cat. No.	Seite Page	Art. Nr. Cat. No.	Seite Page	Art. Nr. Cat. No.	Seite Page
GA031R	1054	GF757R	1097	GF957	725	GK157R	511
		GF763R	1099	GF980R	1103	GK164R	510
GB020R	1006	GF764R	1099			GK165R	510
		GF765R	1099	GH201	9	GK174R	510
GC002R	1054	GF766R	1099	GH204	9	GK180	522
GC004R	1054	GF767R	1099	GH700	9	GK181	522
GC006R	1054	GF768R	1099	GH703	9	GK183	533
GC007R	1054	GF770R	1099	GH712	9	GK185	533
GC008R	1054	GF771R	1099	GH715	9	GK188	533
GC009R	1054	GF772R	1098, 1099			GK193	534
GC010R	1054	GF773R	1098, 1099	GK005R	516	GK194	534
GC012R	1054	GF774R	1098, 1099	GK006R	517	GK200	533
GC013R	1054	GF775R	1099	GK007R	516	GK202	534
GC014R	1054	GF801C	1092	GK008R	517	GK210	533
GC016R	1054	GF805C	1091	GK009R	517	GK211	534
GC391R	1054	GF806C	1091	GK010R	516	GK212	534
GC395R	1054	GF809C	1091	GK012R	516	GK213	533
GC397R	1054	GF816C	1093	GK013R	516	GK216	533
		GF841	1092	GK015R	517	GK217	534
GF350R	1095	GF860R	1093	GK016R	517	GK239	522
GF351R	1095	GF862R	1093	GK017R	517	GK245	522
GF352R	1095	GF867C	886, 1104	GK033R	516	GK246	522
GF353R	1095	GF905R	1104	GK110R	509	GK252Y	507
GF354R	1095	GF906R	1100	GK111R	509	GK253Y	507
GF355R	1095	GF907R	1100	GK112R	509	GK299	523
GF360R	1102	GF908R	1100	GK113R	509	GK301R	514
GF361R	1102	GF909R	1100	GK114R	509	GK303R	514
GF362R	1102	GF910R	1104	GK115R	509	GK305R	514
GF363R	1102	GF911R	1104	GK116R	509	GK307R	514
GF364R	1102	GF912R	1104	GK117R	509	GK310R	514
GF365R	1102	GF913R	1104	GK118R	509	GK315R	514
GF370R	1102	GF917R	1095	GK121R	510	GK320R	514
GF371R	1102	GF918R	1095	GK122R	510	GK321R	514
GF372R	1102	GF919R	1100	GK123R	510	GK424R	512
GF373R	1102	GF923R	1096	GK125R	511	GK550	521, 1105
GF374R	1102	GF925R	1096	GK127R	511	GK595R	526
GF375R	1102	GF932R	1097	GK128R	511	GK596R	526
GF380R	1102	GF933R	1096	GK129R	511	GK597R	526
GF381R	1102	GF935R	1097	GK131R	512	GK604R	527
GF382R	1102	GF936R	1097	GK132R	512	GK605R	527
GF383R	1102	GF937R	1097	GK133R	512	GK606R	527
GF384R	1102	GF938R	1097	GK140R	509	GK624R	527
GF385R	1102	GF939R	1095	GK141R	509	GK625R	527
GF704R	714, 1090	GF940R	1095	GK142R	509	GK680R	514
GF706R	714, 1090	GF941R	1095	GK143R	509	GK681R	514
GF708R	714, 1090	GF942R	1095	GK144R	509	GK683R	514
GF710R	714, 1090	GF944R	885, 1093	GK145R	509	GK685R	528, 620
GF712R	714, 1090	GF946R	885, 1094	GK146R	509	GK690R	523
GF714R	714, 1090	GF947R	885, 1094	GK147R	509	GK700R	525
GF719R	1090	GF948R	885, 1094	GK148R	509	GK701R	525
GF720R	714, 1090	GF950C	725	GK151R	510	GK703R	525
GF721	714, 1090	GF954R	725	GK152R	510	GK711R	525
GF722	714, 1090	GF955R	725	GK153R	510	GK713R	525
GF756R	1097	GF956R	725	GK155R	511	GK720R	523



## Numerischer Index – Numerical Index

GK – LX

Art. Nr. Cat. No.	Seite Page	Art. Nr. Cat. No.	Seite Page	Art. Nr. Cat. No.	Seite Page	Art. Nr. Cat. No.	Seite Page
GK722R	523	GT710	9	JG522R	1108	LX015S	1058
GK723R	523	GT730	9	JG523R	1108	LX016S	1058
GK730R	523	GT736	9	JG524R	1108	LX017S	1058
GK737R	518	GT742	9	JG525R	1108	LX018S	1058
GK738R	518	GT746	9	JG598	1113, 1115	LX020S	1058
GK739R	518	GT748	9	JG600	1113, 1115	LX022S	1058
GK807R	524	GT754	9	JG820R	1109	LX025S	1058
GK808R	524	GT758	9	JG822R	1109	LX030S	1058
GK809R	524	GT770	9	JG850R	19	LX032S	1058
GK881R	528	GT779	9			LX034S	1058
GK882R	528	GT782	9	KX108S	1063	LX035S	1058
GK883R	528	GT784	9	KX110S	1063	LX036S	1058
GK884R	528			KX112S	1063	LX038S	1058
GK885R	528	HF014R	11, 130	KX114S	1063	LX040S	1058
GK886R	528	HF019R	11, 130	KX115S	1063	LX042S	1058
GK891R	529	HF020R	11, 130	KX116S	1063	LX045S	1058
GK892R	529	HF021R	11, 130	KX118S	1063	LX047S	1058
GK893R	529	HF028R	11, 130	KX120S	1063	LX098S	1059
GK894R	529	HF030R	11, 130	KX121S	1063	LX100S	1059
GK895R	529	HF031R	11, 130	KX125S	1063	LX108S	1059
GK896R	529	HF032R	11, 130	KX245S	1063	LX110S	1059
		HF213R	12	KX248S	1063	LX112S	1059
GN073	533	HF234R	12	KX250S	1063	LX114S	1059
GN074	533	HF250R	12	KX255S	1063	LX115S	1059
GN076	533	HF266R	1079	KX260S	1063	LX116S	1059
GN077	533	HF400R	11, 130	KX261	1063	LX117S	1059
GN078	533	HF409R	11, 130	KX262	1063	LX118S	1059
GN080	532	HF514R	13			LX120S	1059
GN081	532	HF519C	13	KY002S	1065	LX122S	1059
GN082	532	HF520R	13	KY003S	1065	LX125S	1059
GN083	532	HF566R	13	KY004S	1065	LX128S	1059
GN084	531			KY005S	1065	LX130S	1059
GN085	532	JF112R	666	KY006S	1065	LX132S	1059
GN086	531	JF212R	665, 666	KY007S	1065	LX134S	1059
GN202	522	JF489R	665	KY008S	1065	LX135S	1059
GN203	506, 513	JF905	665, 666	KY009S	1065	LX136S	1059
GN204	522	JF906R	665, 666	KY010S	1065	LX137S	1059
GN205	506, 513	JF907R	665, 666	KY012S	1065	LX138S	1059
GN206	507	JF908R	665, 666	KY015S	1065	LX140S	1059
GN207	506	JF909R	665, 666	KY100S	1065	LX142S	1059
GN208	507	JF910R	665, 666	KY201R	1066	LX145S	1059
GN209	506	JF915R	665, 666	KY202R	1066	LX146S	1059
GN210	508			KY203R	1066	LX149R	1068, 1075
GN211	508	JG161R	664	KY204R	1066	LX150R	1077
GN212	508	JG170R	664	KY205R	1066	LX152R	1077
GN213	506	JG504R	1108	KY206R	1066	LX156R	1074
GN215	506	JG506R	1108	KY220S	1065	LX157R	1074
GN216	522	JG508R	1108	KY225R	1065	LX158R	1076
GN217	533	JG514R	1108			LX159R	1076
GN218	507	JG515R	1108	LX002R	1059	LX162R	1075
GN221	508	JG516R	1108	LX008S	1058	LX163R	1077
GN227	513	JG518R	1108	LX010S	1058	LX164R	1078
GN229	513	JG520R	1108	LX012S	1058	LX165R	1078
GN310	531	JG521R	1108	LX014S	1058	LX170R	1069

## Numerischer Index – Numerical Index

LX – OA

Art. Nr. Cat. No.	Seite Page	Art. Nr. Cat. No.	Seite Page	Art. Nr. Cat. No.	Seite Page	Art. Nr. Cat. No.	Seite Page
LX171R	1069	LX575R	1085	MB285R	217, 787	MD124R	1096
LX172R	1069	LX582R	1086	MB291R	170	MD125R	1096
LX174R	1070	LX587R	1086	MB454R	170	MD127R	1096
LX175S	1059	LX600R	1087	MB576R	1070	MD129R	1096
LX176R	1067	LX605R	1087	MB603R	344	MD452R	18
LX177R	1070	LX610R	1087	MB613R	821	MD453R	18
LX178R	1070	LX618R	1087	MB657R	1004	MD454R	18
LX180S	1059	LX624R	1087	MB658R	1004	MD455	1025
LX181R	1071	LX901S	1058	MB659R	1004	MD456R	312, 1068
LX182R	1071	LX902S	1058	MB660R	1004	MD463	173
LX183R	1071	LX911S	1058	MB661R	1004	MD464	224
LX185R	1071	LX912S	1058	MB662R	1004	MD465R	224
LX189R	1070	LX913S	1058	MB663R	1004	MD466R	224
LX190R	1071	LX915S	1058	MB664R	1004	MD467R	224
LX202S	1064	LX917S	1058	MB665R	1004	MD468	224
LX203R	1064	LX921S	1058	MB666R	1004	MD469	224
LX204R	1062	LX922S	1058	MB667R	1004	MD470	545, 835
LX205R	1062	LX923S	1058	MB668R	1004	MD497	386
LX206R	1062	LX925S	1058	MB669R	1004	MD563	945
LX207R	1062	LX927S	1058	MB675R	1004	MD568	538
LX208R	1062	LX951S	1058	MB676R	1004	MD569	245
LX209R	1062	LX952S	1058	MB677R	1004	MD570R	245
LX210R	1064	LX953S	1058	MB678R	1004	MD581	362
LX211R	1060	LX955S	1058	MB679R	1004	MD591	262
LX212R	1060	LX957S	1058	MB680R	1004	MD592	262
LX213R	1060			MB681R	1004	MD615	1031
LX214R	1060	MB229R	221	MB682R	1004	MD617	1029
LX215R	1060	MB238R	842	MB683R	1004		
LX216R	1060	MB239R	842	MB684R	1004	ND087R	912
LX218R	1060	MB245	848	MB685R	1004	ND105R	1010
LX222R	1060	MB246	848	MB686R	1004	ND108R	1010
LX223R	1060	MB247	848	MB687R	1004	ND109R	1010
LX225C	1060	MB248	848	MB688R	1004	ND118R	1011
LX227R	1060	MB249	848	MB689R	1004	ND120R	1011
LX228R	1060	MB250	848	MB690R	1004	ND121R	1011
LX235R	1062	MB251	848	MB691R	1004	ND122R	1011
LX237R	1062	MB252	848	MB692R	1004	ND123R	1011
LX240R	1061	MB253	848	MB693R	1004	ND124R	1011
LX241R	1061	MB254	848	MB694R	1004	ND125R	1011
LX265C	1061	MB256	848	MB750R	798		
LX266	1061	MB257	848	MB751R	798	OA200R	458
LX267R	1061	MB258	848	MB785R	404	OA218R	458
LX269R	1061	MB259	848	MB872R	987	OA225R	458
LX310R	1014, 1062	MB260	848	MB873R	987	OA310R	373
LX505R	1082	MB261	848	MB874R	987	OA311R	373
LX522C	1082	MB262	848	MB875R	987	OA312R	373
LX548R	134, 1083	MB263	848	MB876R	987	OA313R	373
LX550R	135, 1083	MB264	848	MB877R	987	OA314R	373
LX552R	135, 1083	MB265	848	MB878R	987	OA332R	360
LX553R	135, 1083	MB275R	930	MB879R	987	OA333R	360
LX556R	135, 1084	MB276R	930	MB880R	987	OA334R	360
LX558R	135, 1084	MB277R	930			OA335R	360
LX565R	134, 1084	MB278R	930	MD076	428	OA336R	360
LX574R	1085	MB279R	971	MD077	428	OA337R	360



## Numerischer Index – Numerical Index

OA – OM

Art. Nr. Cat. No.	Seite Page	Art. Nr. Cat. No.	Seite Page	Art. Nr. Cat. No.	Seite Page	Art. Nr. Cat. No.	Seite Page
OA338R	360	OF261R	348	OK741R	893	OL343R	999
OA340R	373	OF262R	348	OK742R	893	OL401R	978
OA351R	362	OF282R	356	OK745R	894	OL403R	978
OA357R	356	OF283R	356	OK794R	463	OL405R	979
OA358R	356	OF284R	356	OK795R	463	OL406R	979
OA359R	356	OF285R	356	OK900	598	OL407R	978
		OF288R	356			OL408R	978
OB510	347	OF760R	892	OL011R	165	OL409R	978
OB511	347	OF768R	892	OL102R	32	OL410R	978
OB512	347			OL104R	32	OL411R	978
OB513	347	OG164R	962	OL114R	32	OL412R	978
OB514	347	OG165R	962	OL155R	965	OL421R	979
		OG950R	1098	OL157R	969	OL423R	979
OC020R	152	OG951R	1098	OL160R	849, 963	OL425R	979
OC021R	152	OG960R	1098	OL162R	963	OL427R	979
OC022R	152	OG961R	1098	OL163R	963	OL429R	979
OC024R	171	OG962R	1098	OL164R	964	OL601R	361
OC025R	171	OG963R	1098	OL165R	849, 965	OL602R	361
OC026R	171	OG964R	1098	OL166R	965	OL603R	361
OC051R	168	OG969R	1098	OL168R	1103	OL610R	361
OC069R	151	OG970R	1098	OL170R	964	OL611R	362
OC091R	168	OG971R	1098	OL171R	964	OL612R	362
OC094R	168	OG972R	1098	OL177R	1103	OL614R	363
OC100R	170	OG973R	1098	OL179R	965	OL615R	361
OC415R	76	OG974R	1098	OL187R	1101	OL616R	361
OC430R	77			OL189R	515	OL617R	361
OC461R	49	OK093R	570	OL192R	960	OL619R	361
OC480R	48	OK365R	77	OL195R	1103	OL620R	362
OC482R	48	OK366R	78	OL196R	1103	OL621R	361
OC485R	48	OK367R	77	OL198R	963	OL622R	362
OC486R	48	OK368R	77	OL201R	372	OL623R	362
OC491R	49	OK369R	77	OL202R	370	OL624R	362
OC492R	49	OK372R	77	OL206R	363	OL626R	361
OC496R	49	OK373R	77	OL207R	363	OL627R	361
OC497R	49	OK374R	76	OL211R	373	OL652R	33
OC498R	48	OK378R	1038	OL212R	373	OL653R	33
OC499R	48	OK503R	900	OL219R	383	OL654R	33
OC500R	48	OK505R	899	OL220R	383	OL656R	33
		OK506R	899	OL221R	385	OL657R	33
OF001N	6	OK507R	899	OL294R	1001	OL670R	33
OF002N	6	OK508R	899	OL296R	1001		
OF003N	6	OK509R	899	OL298R	1001	OM010	14
OF004N	6	OK520R	899	OL299R	1001	OM015R	14
OF005N	6	OK521R	899	OL300R	1001	OM030R	14
OF006N	6	OK522R	899	OL301R	1001	OM044R	14
OF010N	6	OK525R	901	OL302R	1001	OM047R	15
OF031N	6	OK526R	901	OL303R	1001	OM048R	15
OF033N	6	OK536R	900	OL304R	1001	OM049R	15
OF090	2	OK537R	900	OL307R	1001	OM078R	5
OF237	1099	OK538R	901	OL311R	998	OM079R	5
OF238	1100	OK711R	892	OL314R	998	OM080R	5
OF239	1100	OK712R	892	OL316R	998	OM081R	5
OF257R	348	OK737R	894	OL341R	999	OM082R	5
OF259R	348	OK740R	893	OL342R	999	OM083R	5

## Numerischer Index – Numerical Index

OM – XF

9  
0-0

Art. Nr. Cat. No.	Seite Page	Art. Nr. Cat. No.	Seite Page	Art. Nr. Cat. No.	Seite Page	Art. Nr. Cat. No.	Seite Page
OM084R	5	SF835	587				
OM085R	5	SF836	587				
OM086R	5						
OM087R	5	SR421R	855				
OM088R	5	SR428R	634				
OM089R	5	SR580R	721				
OM090R	5						
OM202R	4, 348	TE749R	478, 479				
OM203R	4						
OM205R	4	US100	489				
OM208R	4	US100201	489				
OM251R	378	US100202	489				
OM252R	378						
OM253R	378	VC100R	584				
OM307R	930	VC101R	584				
OM308R	930						
OM309R	960	XF830	533				
OM311R	961						
OM314R	961						
OM315R	961						
OM485R	185						
OM487R	351						
OM488	347						
OM489R	68						
OM602R	197, 678						
OM670R	1103						
OM671R	1094						
OM672R	1101						
OM680R	31						
OM681R	31						
OP030R	1102						
OP031R	1102						
OP130R	116						
OP151R	581, 704, 705						
OP152R	705						
OP160R	705						
OP161R	705						
OP222R	705						
OP223R	705						
OP230R	705						
OP360R	1102						
OP361R	1102						
OP362R	1102						
OP801	576						
PL561T	744						
PL565T	738						
PL566T	738						
PL567T	740						
PL568T	742						
SF462	587						
SF818R	587						





# AESCULAP®

**B | BRAUN**  
SHARING EXPERTISE

**Aesculap AG**

Am Aesculap-Platz  
78532 Tuttlingen  
Germany

Phone +49 7461 95-0  
Fax +49 7461 95-2600

[www.aesculap.de](http://www.aesculap.de)

All rights reserved. Technical alterations are possible. This leaflet may be used for no other purposes than offering, buying and selling of our products. No part may be copied or reproduced in any form. In the case of misuse we retain the rights to recall our catalogs and pricelists and to take legal actions.